

MHI
Copy 3

FM 2-20

WAR DEPARTMENT FIELD MANUAL

C A V A L R Y

CAVALRY RECONNAISSANCE TROOP

MECHANIZED

WAR DEPARTMENT : 24 FEBRUARY 1944

CHANNON, R. I.

WAR DEPARTMENT FIELD MANUAL

FM 2-20

This manual supersedes FM 17-20, 30 May 1942

CAVALRY

CAVALRY RECONNAISSANCE

TROOP, MECHANIZED



WAR DEPARTMENT • 24 FEBRUARY 1944

United States Government Printing Office

Washington : 1944

For sale by the Superintendent of Documents, U. S. Government Printing Office,
Washington, 25 D. C. - Price 25 cents

WAR DEPARTMENT,
WASHINGTON 25, D. C., 24 February 1944.

FM 2-20, Cavalry Field Manual, Cavalry Reconnaissance Troops, Mechanized, is published for the information and guidance of all concerned.

[A. G. 300.7 (11 Jan. 44).]

BY ORDER OF THE SECRETARY OF WAR:

G. C. MARSHALL,
Chief of Staff.

OFFICIAL:

J. A. ULIO,
Major General,
The Adjutant General.

DISTRIBUTION:

B and H 1, 2, 7, 17 (5); R 1, 2, 7, 17, 18 (2); Bn 2, 7, 17,
18 (5); I C 2 (20).

(For explanation of symbols see 21-6.)

Contents

	Paragraph	Page
CHAPTER 1. GENERAL.		
<i>Section I.</i> Purpose and scope.....	I- 2	1
II. Mission	3	2
III. Organization and equipment.....	4- 6	2
IV. Training	7- 9	5
V. Duties of personnel.....	10- 14	10
VI. Drill, ceremonies, inspections.....	15	16
CHAPTER 2. EMPLOYMENT OF CAVALRY RECONNAISSANCE TROOP, MECHANIZED, INFANTRY DIVISION.		
<i>Section I.</i> General	16- 18	17
II. Reconnaissance	19- 38	18
III. Security	39- 47	36
IV. Combat	48- 55	72
CHAPTER 3. EMPLOYMENT OF CAVALRY RECONNAISSANCE TROOP, MECHANIZED, CAVALRY RECONNAISSANCE SQUADRON, MECHANIZED.		
<i>Section I.</i> General	56- 58	86
II. Reconnaissance	59- 60	88
III. Security	61- 66	89
IV. Combat	67- 68	94
CHAPTER 4. RIVER CROSSINGS.....	69- 76	95
CHAPTER 5. SIGNAL COMMUNICATION.		
<i>Section I.</i> General	77- 83	102
II. Means of signal communication.....	84- 86	104
III. Training	87- 93	106
IV. Miscellaneous	94- 96	112
CHAPTER 6. LOGISTICS.		
<i>Section I.</i> Supply	97-106	113
II. Vehicular maintenance and evacuation... ..	107-111	119
III. Medical service for the troop.....	112-113	121
IV. Prisoners of war.....	114	123
V. Burials.....	115	124
INDEX.....		125

CHAPTER 1

GENERAL

Section I

Purpose and Scope

1. PURPOSE. The purpose of this manual is to present the organization, characteristics, and missions of the cavalry reconnaissance troop, mechanized; and to set forth doctrine for its training and tactical employment.

2. SCOPE. The scope of this manual includes discussion and illustration of organization, equipment, training, and methods of employment of the mechanized cavalry reconnaissance troop and its components, designed to simplify and speed training and to facilitate understanding of basic doctrine.

Section II

Mission

3. MISSION. The cavalry reconnaissance troop, mechanized, is organized, equipped, and trained to perform reconnaissance missions. Other types of missions are given only in the furtherance of a reconnaissance mission of the troop or the squadron of which the troop is a part, unless no other troops are available for other types of operations for the division or other larger unit. Reconnaissance missions are performed by employment of infiltration tactics, fire, and maneuver. Combat is engaged in only to the extent necessary to accomplish the assigned mission.

Section III

Organization and Equipment

4. ORGANIZATION. **a.** For detailed organization and equipment of the cavalry reconnaissance troop, mechanized, see current T/O & E 2-27.

b. The reconnaissance troop, infantry division, is the mobile reconnaissance agency available to the division commander and is employed by him to secure details of hostile organization, strength, and dispositions, the characteristics of terrain, and other information upon which to base a plan of action. It operates within the zone of action assigned to the division in coordination with the ground reconnaissance agencies of higher and lower echelons.

c. The troop organic within the mechanized cavalry squadron acts in like capacity and performs the same type of missions as the reconnaissance troop of the infantry division. The reconnaissance squadron of the armored division differs from that of the cavalry division and group in that it includes four reconnaissance troops instead of three.

d. The mechanized cavalry reconnaissance troop has a troop headquarters and three reconnaissance platoons. Each reconnaissance platoon contains an armored-car section and a scout section. Armored cars and trucks, $\frac{1}{4}$ -ton, are included in the platoon in the ratio of one armored car to two trucks, $\frac{1}{4}$ -ton. This permits flexibility in the organization of reconnaissance teams for specific missions. Three of the $\frac{1}{4}$ -ton trucks mount caliber .30 light machine guns, and each of the remaining three transports a 60-mm mortar and crew. Three of the $\frac{1}{4}$ -ton trucks are provided with short-range radio.

e. Troop headquarters contains command, maintenance, administrative, and supply personnel, and transportation. Armored cars, each mounting an antitank gun and a light machine gun, are included for command, maintenance, and liaison functions. There are $\frac{1}{4}$ -ton trucks for messenger and traffic-control duties, half-track personnel carriers to transport essential supplies and provide maintenance facilities, and a $2\frac{1}{2}$ -ton cargo truck to provide kitchen facilities. A liaison detachment consisting of an officer and five enlisted men, with an armored car and a $\frac{1}{4}$ -ton truck, intended primarily for liaison with division headquarters, is provided in the cavalry reconnaissance troop assigned to the infantry division. The reconnaissance troop of the infantry division has three mechanics, automobile, for second echelon maintenance, a motor supply corporal, and an additional half-track vehicle, which are not found in the reconnaissance troops of mechanized cavalry squadrons.

f. Each reconnaissance platoon is tactically self-contained. By attachment of transportation from troop headquarters, two of the three platoons can operate on detached missions beyond supporting range of the remainder of the troop.

5. TACTICAL VEHICLES. Elements of the mechanized reconnaissance troop are mounted in various types of wheeled and half-track vehicles, the characteristics of which must be appreciated in order to employ the unit effectively. Each tactical vehicle carries a ground mount for each type of machine gun mounted in or on the vehicle.

a. Light armored car, M8. Armored cars are the basic command and communication vehicles. The light armored car, M8, is a 6 by 6 vehicle, weighs 16,400 pounds with equipment and crew, and is capable of cruising from 100 to 250 miles cross country or 200 to 400 miles on highways without refueling. On a level, improved road, it can sustain a speed of 55 miles per hour. Each armored car is equipped with a long-range radio set to assist in the exercise of command or for the purpose of relaying information received from subordinate elements to higher headquarters, and a short-range radio set for communication within a platoon, reconnaissance team, or headquarters. The armor of the vehicles provides a fair degree of protection against small-arms fire, while the 37-mm antitank gun permits mobile defense against lightly armored vehicles at ranges not exceeding 400 yards when armor-piercing ammunition is used. The gun also fires canister and high explosive shell. Each armored car is equipped with one caliber .30 machine gun, light, for use against personnel. An anti-aircraft machine gun may be added, located so that it can be fired from the turret. The vehicle is not designed for offensive combat. The car has only fair mobility across country. Mobility is limited in heavily wooded areas and on broken terrain. The large turning radius and limited mobility across country make the car susceptible to ambush on roads and in defiles.

b. Truck, 1/4-ton. The 1/4-ton truck is the basic reconnaissance vehicle. The dominant characteristics of the 1/4-ton truck are low silhouette, speed, and exceptional cross-country mobility. These characteristics facilitate concealment and effective use of the minimum amount of cover. It is the cross-

country scouting vehicle of the troop; it is not designed for offensive combat. Equipped with short-range radio, ¼-ton truck patrols extend materially the range and effectiveness of the armored car. During maneuvers, they provide the means of transporting fire power rapidly and effectively to outflank resistance.

c. To disable vehicles. For details of methods to be employed in the destruction of vehicles which, owing to limitations of time or transportation, it will be impossible to evacuate, see FM 25-10.

6. WEAPONS. α. The types and number of weapons issued to the personnel of the mechanized reconnaissance troop are indicated in T/O & E 2-27; details of vehicular armament are included in current Technical Manuals. Each armored car is equipped with a 37-mm antitank gun and one caliber .30 light machine gun. Other vehicles are equipped with 60-mm mortars, caliber .50 (HB) and caliber .30 (light) machine guns, and antitank rocket launchers. Personnel of the troop is armed with caliber .30 carbines, caliber .30 rifles, caliber .45 submachine guns, and hand grenades.

b. For characteristics and employment of weapons, see Field Manual for the weapon concerned.

Section IV

Training

7. OBJECTIVE. α. Purpose. Basic, technical, and tactical training is conducted to develop—

(1) In the individual, excellent physical condition, discipline, and high morale; an aggressive spirit; and high standards of proficiency in the technique of employing weapons and matériel.

(2) In the troop, the ability, through trained leaders, to operate as an efficient reconnaissance team. Attainment of these objectives can be realized only by painstaking training of individuals and the unit.

b. Intelligence training. It is essential that personnel in all grades appreciate fully the importance of combat intelligence. The individual must be given a clear, workable understanding of military intelligence and how he can contribute to its procurement. In addition to training in observation as outlined in FM 21-45 and in reporting information according to standing operating procedure, train the soldier to observe and report *any* information which may be of value. Each commander should receive intelligence training, compatible with his responsibility, to enable him to determine the importance of information received, and to report promptly to the appropriate agency the proper digest of information received.

8. SCOPE. a. Subjects for training are found in MTP 2-2. Since the primary mission of the troop in combat is reconnaissance, the following should be emphasized:

(1) How to observe and how to describe what has been observed (FM 30-10).

(2) Ability to move rapidly under all conditions of terrain and weather, either by vehicle or dismounted (FM 21-45 and 25-10.)

(3) How to obtain information by stealth while avoiding opposition (FM 21-45 and FM 21-75 (when published)).

(4) Skill in concealment; dismounted as well as mounted scouting (FM 21-45 and FM 21-75 (when published); TF 7-234, 7-275, and 7-280.)

(5) A high standard of map and aerial mosaic reading, including sketching and knowledge of conventional signs used by the enemy (FM 21-25, 21-26, 21-45, and 30-22; TF 5-12 and 7-233; TM 30-450 and 30-480.)

(6) Terrain appreciation. (FM 101-5.)

(7) Expertness in framing oral and written messages and reports. (FM 21-45.)

- (8) Proficiency in the operation of all weapons (FM 23 series.)
- (9) Skilful operation and efficient maintenance of vehicles. (FM 25-10; TM 21-300, 31-200, and pertinent Technical Manuals of the 9 series and the 10 series.)
- (10) Proficiency in the use of expedients in the crossing of vehicles over unfordable streams by the use of rubber boats, amphibian vehicles, improvised rafts, or, block and tackle, and difficult terrain operations. This instruction should include precautions necessary in order to prevent damage to vehicles due to immersion. (FM 5-10 and 25-10; ch. 4 of this manual.)
- (11) Proficiency in radio transmission and radio set maintenance, to include the training of all members of the troop in some aspects of signal communication. (Ch. 5 of this manual; FM 24-6 and 24-10; TM 11-454, 11-455, and 11-461.)
- (12) Identification of enemy uniforms and markings, armored vehicles, and aircraft. (FM 30 series; TM 30-450 and 30-480.)
- (13) Proficiency in the employment of demolitions and road blocks and in the reduction and removal of road blocks. (FM 5-20.)
- (14) Proficiency in road and bridge reconnaissance. (FM 5-10.)
- (15) Methods to be employed in destroying organic vehicles and weapons when such action becomes necessary. (FM 25-10 and appropriate weapons manuals.)
- (16) Proficiency in air-ground communication by panels, pyrotechnics, lights, and radio. (Ch. 5 of this manual.)
- (17) Proficiency in the use of field expedients in the chemical decontamination of vehicles, arms, and equipment. (TM 3-220; TF 7-275 and 7-280.)
- (18) Familiarity with handling of prisoners. (FM 30-15; TF 1-674.)
- (19) Familiarity of officers and senior noncommissioned officers with qualifications and duties of liaison officers. (FM 101-5.)
- (20) Elementary navigation; the use of the odometer to register

distance from a known point; use of the compass, watch, sun, and stars to maintain direction; "preparation and maintenance of a simple strip map. (FM 21-25 and 21-26; TF 7-233.)

(21) Methods to be employed in safeguarding military information, reports, and messages; to include signal security and the preparation of messages for transmission by nonsecret means. (AR 380-5; FM 30-25; TF 11-205, 11-324, and 11-325.)

(22) Proficiency in the location, installation, detection, passage, and removal of mine fields. (FM 5-25.)

(23) Proficiency in the installation, detection, and removal of booby traps and warning devices. (TF 5-954.)

(24) Ability to act as forward observers for artillery. (FM 6-40.)

b. Upon completion of the initial training phase, individuals and units must continue to practice their varied duties to maintain the required degree of proficiency. The goal to be sought in training is to make members of vehicle crews sufficiently proficient in the duties of other members so that they may be interchangeable in an emergency.

c. Members of the troop must be able to operate and maintain themselves for extended periods in cross-country dismounted operations. For this reason, physical training must receive the constant attention of all commanders.

d. Individual training must develop such skill in the technique of handling weapons and other matériel that correct procedure is followed habitually. The scope of basic and technical instruction of individuals is detailed in MTP 2-2, which may be used as a general guide.

e. After basic and technical training of individuals has progressed sufficiently to permit integration into teams, small unit tactical exercises should be started. Unit tactical training should be designed to promote teamwork and leadership in the application to combat situations of technique and tactical doctrine. It is only by combined training of elements that maximum combat effectiveness of tactical groups can be assured. Tactical

proficiency is developed by map and sand table and by exercises in the field under simulated war conditions. Operations of mechanized cavalry and reconnaissance aviation are complementary and every opportunity for operation with aviation must be taken.

9. METHODS. **a.** Training methods will include decentralization, balanced progressive programs, and applicatory tactical exercises, in keeping with established training doctrines and making maximum use of all available training aids. At times, it may be necessary to centralize training where the number of trained instructors or the supply of available weapons or other equipment is limited.

b. The troop commander is responsible for the training of his unit. However, he should delegate specific duties and responsibilities to subordinate leaders. He will further the training of such leaders in command and leadership concurrent with individual and collective training.

c. Each training phase must occur in logical sequence, and each subject must be developed through easily understood words and methods so that each individual receives a secure foundation from which to proceed to more advanced requirements. Experience has shown repetition of the application phase to be desirable, if time and facilities permit. Subsequent to the attainment of the desired proficiency, training in any subject must be repeated to insure maintenance of satisfactory standards.

d. Full use should be made of Training Films, Film Strips, and other training aids. For a complete list of publications for training, including Film Strips and Training Films, see FM 21-6 and 21-7.

Section V

Duties of Personnel

10. HEADQUARTERS SECTION. **a. Troop commander.**

The troop commander is responsible for the training, administration, maintenance, supply, and employment of the troop. In combat, he assigns missions to platoons, supervises their operations, and maintains control of and communication with them. The troop commander of the infantry division reconnaissance troop may remain for short periods at the division command post in his capacity of special staff officer.

b. Troop executive officer. (1) The executive officer, who also is motor officer, accompanies the forward echelon. As second in command, he assumes the duties of the troop commander in the latter's absence. He is in charge of the communication net; his car contains the message center. He supervises the training and operation of the headquarters section, except for the liaison and communication detachment in the cavalry reconnaissance troop of the infantry division.

(2) As troop motor officer, he supervises the training and work of troop mechanics and the training of drivers. He makes frequent inspections of the motor vehicles and advises the troop commander on matters pertaining to vehicle maintenance and supply. He requisitions spare parts and controls their distribution. (FM 25-10.)

c. Liaison and communications officer. Liaison between the infantry division reconnaissance troop and division headquarters is effected by the liaison and communication detachment, consisting of an officer with vehicles and crews. The troop liaison officer at division headquarters assists in the transmission of information and informs the troop commander of changes in plans or operation of the division. The liaison officer should accompany the troop commander when the latter visits division headquarters in order that he may have full

knowledge of the situation and the projected employment of the troop. He is responsible for the training of the personnel of his own section and of the communications personnel of the troop. Duties of the liaison officer are covered in FM 101-5.

d. Communication chief. The communication chief assists the liaison and communications officer of the infantry division reconnaissance troop in training communication personnel. He will perform similar duties under the supervision of the troop officers designated as communications officers in reconnaissance troops of mechanized cavalry squadrons, wherein no communications officers are provided specifically by Tables of Organization. In the field, he assists the executive officer in supervision of communication personnel and in establishing the troop command post, and assumes delegated responsibility for encoding and decoding of messages. He rides in the troop commander's car, but may be shifted when needed to the executive officer's vehicle.

e. Liaison agents. Liaison agents perform messenger and liaison functions. They ride in $\frac{1}{4}$ -ton trucks. They must be thoroughly trained in map reading and in movement without benefit of maps.

f. Bugler. The bugler sounds calls, and serves as a messenger. He drives a $\frac{1}{4}$ -ton truck.

g. Drivers. Drivers operate vehicles as assigned, perform first echelon maintenance, and must be capable of replacing gunners or radio operators. For training of drivers, see FM 25-10, TM 21-300, and TM 21-301.

h. Radio operators. Radio operators operate and maintain radio sets installed in the vehicles in which they ride. (For training of radio operators see ch. 5.) They assist in encryptographing and decryptographing messages, and act as assistant gunners or relief drivers.

11. ADMINISTRATIVE, SUPPLY, AND MESS SECTION.

a. First sergeant. The first sergeant assists the troop commander in administration of the troop. He is in immediate charge of the enlisted personnel and records of the troop.

When the troop is in action, he assists the executive officer in establishing the troop command post and supervising the activities of the forward echelon. He maintains a record of all combat orders and messages.

b. Mess sergeant. The mess sergeant is in charge of the troop mess under the supervision of an officer designated by the troop commander as mess officer. The executive officer is mess officer in the field, but in training this duty may be rotated among officers of the troop. The mess sergeant supervises training and operations of cooks, cooks' helpers, and kitchen police. He is responsible for estimating ration needs and providing the first sergeant with the information required to complete the ration section of the morning report. In combat or active reconnaissance operations, the mess sergeant establishes the kitchen at the rear echelon, but assists the mess officer by going wherever required to assure that the troop is fed efficiently. He rides in the kitchen truck.

c. Supply sergeant. The supply sergeant obtains and delivers supplies and is responsible for troop property and records. He commands the troop train and supervises plans for re-supply, movement and distribution of supplies, to include arrangements for traffic control, guides, train security, and rendezvous points. He prepares daily strength and expenditure reports for classes I, III, and V supplies. He is responsible for training and supervising ammunition agents, motor supply corporal, and armorers. He rides in a $\frac{1}{4}$ -ton truck with the service element of the troop.

d. Ammunition agents. Ammunition agents are assistants of the supply sergeant. They keep posted at all times on the status of ammunition supply, and prepare ammunition expenditure reports. They help the supply sergeant to distribute ammunition to the troop.

e. Troop clerk. The troop clerk is the first sergeant's assistant and performs duties pertaining to the administration of the troop. In addition, he must be skilled in both mounted

and dismounted scouting and patrolling, map reading, duties of messenger, traffic control, and duties of guide.

f. Cooks. Cooks prepare and deliver meals under the supervision of the mess sergeant. They must be capable of acting as relief drivers and aiding in defense in the troop rear echelon.

g. Ammunition handlers. Ammunition handlers assist the ammunition agents and drivers in loading and unloading ammunition and other supplies carried in half-track vehicles of the troop train in which they ride. They also are responsible for operating machine guns mounted on vehicles.

h. Basic privates. Basic privates are provided in Tables of Organization for replacement of personnel absent, sick, in confinement, or for other routine reasons. Some should be trained in the duties of each position filled by privates first class or privates.

12. MAINTENANCE SECTION. **α. Motor sergeant.**

The motor sergeant is the principal assistant of the motor officer. He is in direct charge of the mechanics.

b. Mechanic chief. The mechanic chief must be able to organize and direct a maintenance team. He must be able to detect and diagnose mechanical difficulties in vehicles and initiate and supervise repair. He supervises the operations of the troop mechanics in the recovery and repair of damaged vehicles and such other work as may be assigned by the motor sergeant. He rides in a vehicle of the maintenance section.

c. Car commanders. Car commanders command the cars in which they ride and supervise training and operations of enlisted personnel; they assure march discipline and first echelon maintenance. When in command of an armored car, the car commander assists the gunner by loading the 37-mm gun and machine gun; if provided with an antiaircraft gun, he is responsible for operation of the weapon. He must be trained as an alternate driver, gunner, and radio operator.

d. Motor supply corporal. The motor supply corporal assists the motor maintenance sergeant in the performance of

his duties and advises him in matters pertaining to motor vehicle supply. He assists in the supervision of the operations of the motor maintenance section personnel; knows at all times the status of motor supplies, and cooperates under the maintenance sergeant with the troop supply sergeant in requisitioning, obtaining, and distributing gasoline, oil, lubricants, spare parts, and maintenance equipment. He rides in one of the vehicles of the motor maintenance section.

e. Armorers. Armorers repair the troop weapons and establish and operate the machine-gun belt-filling station. In addition, they must be skilled in both mounted and dismounted scouting and patrolling, map reading, acting as messenger, traffic control, and the duties of a guide.

f. Mechanics. Mechanics, assisted by vehicle drivers, perform second echelon maintenance for troop motor transportation (par. 108). In the reconnaissance troop of the infantry division, three mechanics are provided in addition to those authorized for other cavalry reconnaissance troops. This personnel with its additional tool sets makes possible the performance of second echelon maintenance which, in troops of the cavalry reconnaissance squadron, would be performed by squadron maintenance personnel. Mechanics must be capable of operating vehicular weapons and voice radio.

g. Radio repairman. The radio repairman is responsible for the maintenance of troop radios under the supervision of the communication sergeant. He assists the communication officer and communication sergeant in the training of all radio operators in preventive and scheduled maintenance. He drives a vehicle of the maintenance section.

13. ARMORED-CAR SECTION. α. Platoon leader.

The platoon leader commands and trains the personnel of the platoon as individuals and as a unit, and executes tactical missions directed by the troop commander. He is responsible for first echelon maintenance of motor vehicles in his platoon. He supervises operations and missions of the elements of his platoon. He takes position where he can best control the action

of his unit. When the platoon is on reconnaissance, he rides well forward in the platoon formation. If moving cross-country in a deployed formation, he will be located centrally between the forward security detachment and the remainder of the platoon.

b. Platoon sergeant. The platoon sergeant assists the platoon leader and commands the platoon in his absence. He rides or goes where he best can assist in the control of the platoon or an element thereof. When on reconnaissance or moving as a platoon, the platoon sergeant rides near the rear of the column. When the platoon subdivides into reconnaissance teams, he leads a team.

14. SCOUT SECTION. a. Section leader. The section sergeant has the duties of car commander of the vehicle in which he rides. He commands the scout section and is responsible, under the supervision of the platoon leader and platoon sergeant, for the training and operations of its personnel. He may be detached as commander of a security detachment or patrol.

b. Squad leaders. The squad leader is the car commander of the vehicle in which he rides. He may be the second in command within a reconnaissance team. He assists the team leader in supervising and controlling operations of personnel of the team, and the operation and maintenance of vehicles and equipment. He assumes command in the event that the team leader becomes a casualty.

c. Gunners. Gunners are responsible for the care, cleaning, functioning, and firing of the guns of their respective vehicles. (See appropriate Field Manuals of the 23 series.) When in an armored car provided with an antiaircraft machine gun, the gunner will assist the car commander in the operation of the antiaircraft weapon by traversing the turret. They must be capable of replacing drivers and radio operators.

d. Riflemen. Riflemen, together with section and squad leaders, all of whom ride in the $\frac{1}{4}$ -ton trucks of the scout sections, may be used to form parties for dismounted scouting,

patrolling, or combat. In addition, they act as radio tenders and machine gunners or relief drivers. Their training must emphasize dismounted operations.

Section VI

Drill, Ceremonies, Inspections

15. DRILL, CEREMONIES, AND INSPECTIONS. α.

The procedures, formations, and movements for dismounted drill, ceremonies, and inspections follow those prescribed in FM 22-5.

b. Mounted drills and ceremonies are conducted as prescribed in FM 2-7 (when published).

CHAPTER 2

EMPLOYMENT OF CAVALRY RECONNAISSANCE TROOP, MECHANIZED, INFANTRY DIVISION

Section I

General

16. MISSION. The cavalry reconnaissance troop, mechanized, infantry division, is organized, equipped, and trained to perform reconnaissance missions. It is the mobile reconnaissance element available to the division commander. The troop performs close and battle reconnaissance within zones or areas, or along designated routes or axes. It performs distant reconnaissance exceptionally.

17. METHOD OF OPERATION. The troop employs infiltration tactics, fire, and maneuver to accomplish reconnaissance missions. It engages in combat only to the extent necessary

to accomplish the assigned mission and to avoid destruction or capture. The troop should be reinforced before departing on a mission when sustained combat or the crossing of obstacles is anticipated. Infantry, field artillery, tanks, tank destroyers, and engineers are suitable attachments.

18. COORDINATION. Reconnaissance aviation furnishes higher commanders with information of large enemy concentrations and movements. The employment of the reconnaissance troop is based on this information and information received from other sources. The operation of the reconnaissance troop is coordinated with nondivisional reconnaissance agencies and with the reconnaissance elements of divisional infantry, field artillery, engineers, tank destroyer, and other attached units.

Section II

Reconnaissance

19. GENERAL. The troop is employed to gain timely information upon which the division may base decisions and plans. Contact is gained with large enemy forces at the earliest practicable moment and maintained thereafter. The troop seeks to identify hostile units and to determine their strength, composition, disposition, and movement. Terrain features and conditions which may affect operations are reported in addition to information of the enemy.

20. DEPTH, RATE OF ADVANCE, AND FRONTAGE. a. The time interval by which the reconnaissance troop precedes the division in an advance must be determined in each instance. Visibility, terrain, anticipated enemy contact, nature of information sought, and other factors which affect the rate of advance are considered.

b. The reconnaissance troop can march from 150 to 200 miles daily on good roads at a rate of 35 miles per hour. When engaged in active reconnaissance, units can advance at a rate of 10 miles per hour on open terrain under favorable conditions. Unfavorable conditions may reduce the rate to that of dismounted reconnaissance.

c. The troop can reconnoiter a zone 10 miles wide with one platoon in support initially (par. 29).

21. ROUTES, ZONES, AND AREAS. α. To avoid duplication of effort and to facilitate control, a zone, area, axis, or route is assigned to each reconnaissance unit. Boundaries are designated to fix responsibility. They do not prohibit maneuver by units in adjacent zones or areas. The division commander assigns an area or zone of responsibility to the troop and informs all other reconnaissance agencies within the division.

b. Reconnaissance of a route is prescribed when it is desired to determine whether or not a particular route is being used by the enemy or is practicable for use by elements of the division.

c. Reconnaissance of a zone is performed in front of the division when it advances. The troop must be aggressive so that the division is not delayed. However, the reconnaissance troop must be allowed adequate time. The more detailed the information desired, the more time must be allowed.

d. Reconnaissance of an area is performed to search for information in a definite locality. Other elements of the division may or may not advance into or through the area.

22. RECONNAISSANCE BY FIRE. Fire on a suspected enemy position may cause the enemy to disclose his presence by movement or by returning fire. This method is employed at the risk of disclosing the presence of the reconnaissance unit.

23. CONTROL. **a.** An axis may be prescribed to control direction of advance of reconnaissance units. Phase lines and objectives may be designated to control rate of advance, or the distance to be covered in a period of time may be prescribed. Phase lines should be roads, railroads, towns, or prominent terrain features.

b. Radio provides the principal means of controlling and directing reconnaissance elements. Flags and arm-and-hand signals may be employed where practicable. (See FM 2-7 (when published).) Vehicular or dismounted messengers may be used to transmit messages, maps, sketches, or overlays. Radio silence may necessitate the use of messengers for all communication. Lateral communication between reconnaissance elements is maintained by radio or messenger. Lateral contact is established where practicable on phase lines and at designated objectives.

c. Assembly points are designated so that elements can reorganize if dispersed. A new assembly point is announced at each halt. The position selected should permit dispersion of vehicles and should afford concealment and defilade.

24. ORDERS AND RECONNAISSANCE INSTRUCTIONS.

a. The reconnaissance mission is assigned to the troop as a unit. Each mission is given a priority when more than one is assigned. The troop commander allots tasks and coordinates operations of platoons.

b. Missions must be specific. If they are not, commanders request clarification. Instructions to all echelons must be complete and must include exactly *what* information is to be secured; *where* the information is to be sought; and *when* the mission is to be executed. Essential details include—

- (1) Pertinent information of the enemy and friendly troops.
- (2) Plan of operation of the division commander.
- (3) Specific information desired.
- (4) Zone, area, route, or axis.
- (5) When, where, and how information is to be reported to the higher commander.

- (6) Time of departure.
- (7) Phase lines, when desirable, and objectives, and the time they are to be reached.
- (8) Expected duration of mission.

c. Whenever possible, platoon and team leaders are assembled for initial orders to insure that measures for mutual support and for cooperation with other troops are understood. Objectives and routes are indicated graphically by the troop commander on the best map or map substitute available and are copied by platoon and reconnaissance team leaders. After active reconnaissance has started, orders to platoon and team commanders are disseminated by radio, messenger, or by the troop commander or executive officer in person.

25. TRANSMISSION OF INFORMATION. Transmission of information is facilitated by standing operating procedure. This procedure establishes priorities which apply in the absence of specific instructions. The use of standing operating procedure simplifies orders and facilitates the transmission of essential information. Items of information which should be assigned priorities are—

a. Location and time of each enemy contact, giving strength, composition, and direction of movement of hostile forces. First contact with the enemy is especially important.

b. Number, type, location, direction, and speed of movement of enemy armored vehicles, airborne troops, naval combat, and landing forces.

c. Identification of enemy units.

d. Number, type, location, and direction of flight of hostile aircrafts.

e. Condition and type of routes and bridges.

f. Location of mine fields, other obstacles, and contaminated areas, and routes by which they may be avoided.

g. Terrain features and conditions which may affect operations.

h. Location and movement of friendly troops.

i. Location of supplies.

26. REPORTS. Teams (par. 27) and platoons on reconnaissance report factual information. Reports are relayed by radio or messenger to higher headquarters. The troop commander may enter a platoon radio net to intercept messages or secure more detailed information. A log is maintained by platoon and troops commanders to record data upon which to base reports. When information is transmitted on marked maps or sketches, conventional signs and symbols should be used. (FM 21-30.)

27. OPERATION OF RECONNAISSANCE TEAMS. **a.** Reconnaissance teams composed of armored cars and ¼-ton trucks operate under platoon control; exceptionally, teams detached to occupy observation posts (par. 30) may operate under troop control. Teams move across country wherever practicable when enemy forces are believed to be near. Roads are covered by observation unless their detailed reconnaissance is included in the mission (par. 33). Echelons of a team move by bounds (fig. 1), utilizing available cover and concealment. The leading echelon, a ¼-ton truck or trucks, moves to successive observation points along a route or axis of advance. The team leader rides in the second echelon directing the advance of the team and following the leading echelon to successive bounds as they are secured. Additional ¼-ton trucks are utilized to reconnoiter between bounds or to the flanks. Figure 2 shows methods of operation of a team composed of one armored car and two ¼-ton trucks.

b. Terrain and the situation may require the use of dismounted patrols (FM 21-75 (when published)) or reconnaissance by fire to supplement observation. Guns on armored cars, mortars, and automatic weapons support the movement of ¼-ton trucks and dismounted men. Areas favorable for the use of mines are examined prior to committing the bulk of the patrol (par. 35).

c. Reconnaissance teams attempt to secure observation points from which enemy forces can be observed (par. 30). Contact is maintained with enemy forces the size of a company or

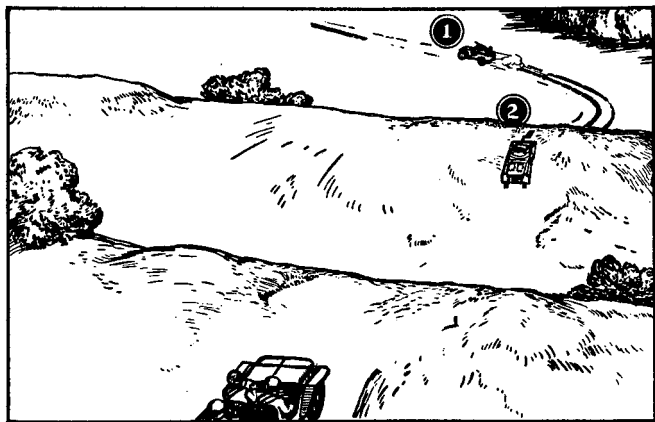
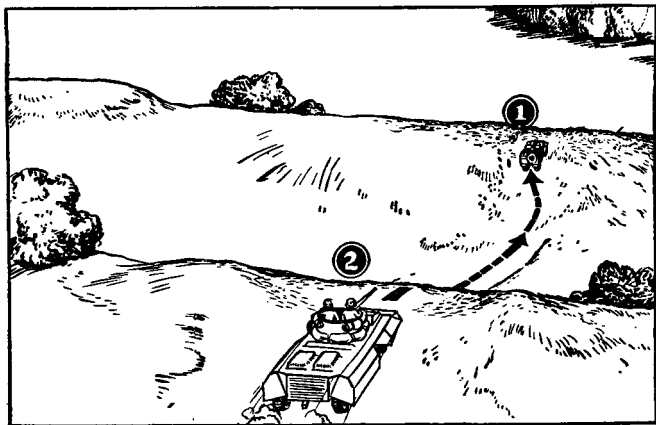

Figure 1. Reconnaissance elements advance by bounds. Each vehicle (2) covers the advance of the vehicle immediately preceding (1).

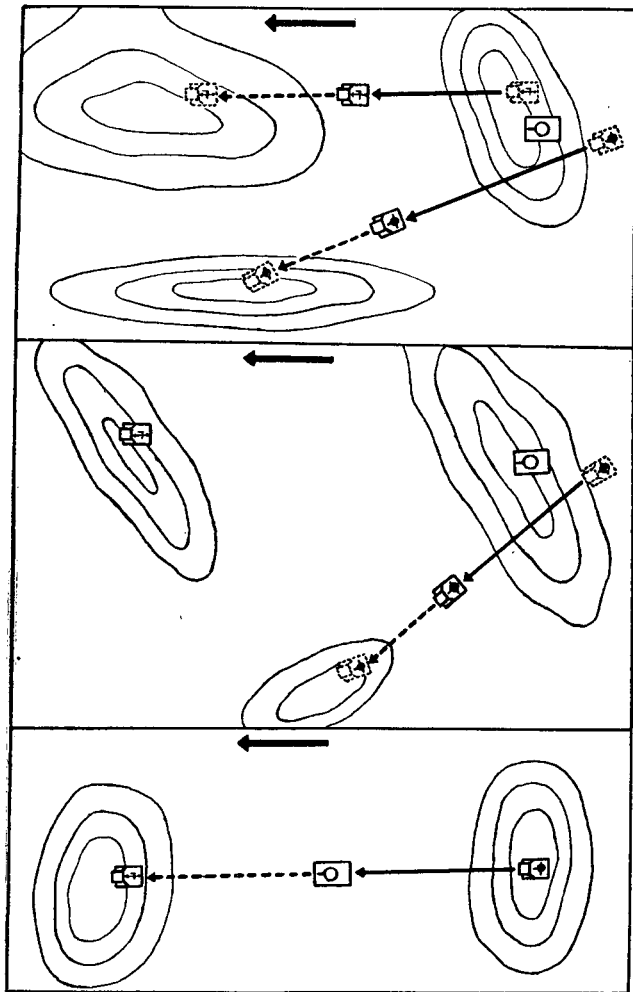

Figure 2. A reconnaissance team operating under varying conditions of observations. A team may be composed of three, four, five, or six vehicles.

larger pending instructions from the platoon leader. Enemy patrols are reported and avoided if practicable.

d. Moving vehicles take cover when fired upon; those not in motion support by fire. Dismounted personnel reconnoiter to determine the enemy's strength and dispositions and to discover routes by which the enemy position can be bypassed. Dismounted reconnaissance parties are covered by the fire of suitable weapons. A report is made to the platoon leader who directs subsequent action. If the enemy withdraws, the team continues on its mission.

e. When the team is attacked by a small enemy patrol, it may defend, to hold an observation point, bridge, or defile in order to accomplish reconnaissance missions. When attacked by a large force, the team conducts a delaying action to secure freedom of movement for an advance in a new direction in order to continue on the assigned mission. A report is made to the platoon leader, who directs subsequent action.

28. OPERATION OF PLATOONS. **a.** The platoon is the basic reconnaissance unit. It is organized to operate under troop control within a designated zone or area, or along a prescribed route or axis. The frontage for a platoon reconnoitering a zone should not exceed 4 miles. The number of reconnaissance teams formed and their composition depend upon the frontage assigned, routes available to the enemy, terrain, and the rate of advance required. Three reconnaissance teams are considered the maximum number which can be formed within a platoon. Teams are composed of armored cars and $\frac{1}{4}$ -ton trucks where conditions are favorable. Conditions may necessitate the formation of teams composed of one type of vehicle only or the platoon may operate without vehicles. The platoon leader should retain a support initially.

b. Platoon leaders control teams by voice radio, supplemented by visual signals and messengers when practicable. When control is difficult, movement is regulated by prescribing objectives or phase lines (par. 23).

c. When an element of the platoon reports contact with the enemy, the platoon leader estimates the capabilities of the enemy force. He confirms reports of large enemy forces by personal reconnaissance. Enemy strength may necessitate a change in plan to accomplish the platoon mission. The platoon leader reports the situation to the troop commander and states his plan of action.

d. The platoon avoids enemy patrols. Elements of the platoon maneuver to unopposed routes and continue on the mission. It may be necessary to pin the enemy by fire to permit maneuver. Movement of the platoon in bypassing an enemy patrol may be limited to a single route. When an enemy force the size of a company or larger is encountered, the platoon maintains contact pending instructions from the troop commander.

e. The platoon is the smallest unit to initiate an attack. When it becomes necessary to engage in combat with an enemy force which threatens the success of the mission, the platoon attacks. Surprise, speed, and coordination are essential. The enemy force is located accurately. Vehicles are used for maneuver where practicable. When reconnaissance indicates enemy strength beyond the capabilities of the platoon, reinforcement by other elements of the troop is requested before an attack is initiated.

29. OPERATION OF THE TROOPS. a. The reconnaissance troop is organized to operate as a unit under division control. The troop commander receives reports from platoons and relays information to division headquarters. The troop liaison officer at division headquarters assists in the transmission of information and informs the troops commander of changes in plans or operations of the division.

b. Reconnaissance troops of infantry divisions supplement the operations of corps reconnaissance elements. The corps commander assigns areas or zones of responsibility to divisions and to corps. Within division areas or zones assigned by the corps commander, reconnaissance troops may be assigned recon-

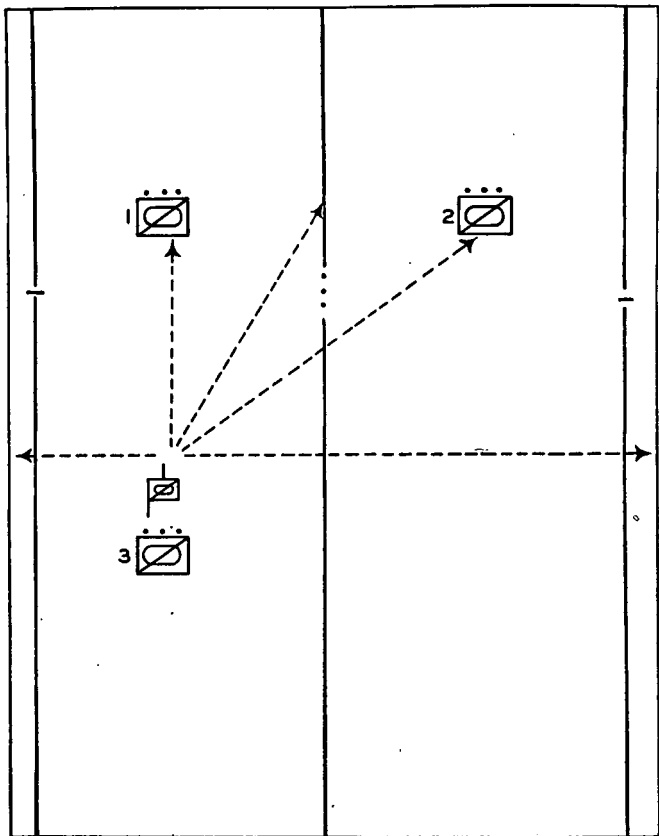

Figure 3. The troop operates with two platoons assigned initially to active reconnaissance. The third platoon follows in support. The support may be employed later to pass through a gap or weak point in the enemy security screen, to pass around his flank, to assist another platoon, to perform a supplementary reconnaissance mission, or to maintain liaison.

naissance missions or liaison responsibilities. The troop of a flank division may operate toward an exposed flank. It will be desirable frequently for a troop to attach a liaison detail to the corps reconnaissance unit.

c. The troops can reconnoiter a zone 10 miles wide with one platoon in support. Reconnaissance is conducted to the division front before opposing forces close. When the width of the division zone exceeds the capabilities of the troop, the responsibility for reconnaissance in part of the zone is assigned to other units or the troop is reinforced. The troop commander prescribes platoon zones, areas, routes, or axes (par. 21).

d. The troop operates with two platoons assigned initially to active reconnaissance (fig. 3). The third platoon follows in support. The support may be employed later to pass through a gap or weak point in the enemy's security screen, to pass around his flank, to assist another platoon, to perform a supplementary reconnaissance mission, or to maintain liaison.

e. Platoons are controlled by voice or CW radio supplemented by vehicular messengers. Movement is regulated by prescribing objectives or phase lines. The location or axis of advance of troop headquarters must be known by all elements of the troop.

f. Active reconnaissance missions should be rotated so that platoons have opportunity for maintenance and rest.

g. The troop reports all contact with enemy forces to division headquarters. Information of enemy forces is transmitted also to units whose security is threatened. The troop commander maneuvers his support to avoid enemy patrols reported by platoons.

h. It may be desirable to relieve reconnaissance units when opposing forces close. Division reconnaissance troops then may be employed on reconnaissance missions toward an exposed flank, may be used to maintain liaison with adjacent units, or may be placed in reserve.

i. The troop may be employed without vehicles to conduct battle reconnaissance and to operate over terrain impassable to

motor vehicles. When reconnoitering without vehicles, the troop employs dismounted patrols, observation posts, and listening posts. Vehicles may be left in rear divisional areas or concealed in forward areas ready for immediate use. For dismounted patrolling see FM 21-75 (when published).

30. OBSERVATION AND LISTENING POSTS. a.

Observation posts are established to observe movement of enemy troops or activity in enemy installations. Listening posts are occupied to detect enemy movement or activity when visibility is limited. Localities for observation and listening posts are chosen after careful map study when terrain reconnaissance is impracticable. The actual site is selected on the ground, located on a map, and reported to commanders. Locations of observation and listening posts are plotted accurately on a map and are used as reference points in reporting information. Positions are approached in daylight by concealed routes or during hours of darkness. After posts are occupied, movement in daylight is limited.

b. An observation post must afford a field of view for at least one observer, and concealment for personnel and equipment. A convenient route of withdrawal is desirable. High ground and the edges of woods or towns are favorable sites. Observers should not occupy conspicuous buildings, isolated trees, or prominent crests.

c. Personnel occupying observation posts is held to the minimum required for continuous observation, reasonable security, and adequate communication. The degree to which the position is organized is determined by the length of time it is to be occupied. Observers and sentries are posted, weapons are sited, communications are installed, and fox holes are dug. Camouflage supplements natural concealment. Vehicles are concealed close to the position where practicable.

d. Listening posts are established along routes available to the enemy or near enemy concentrations. Personnel is limited to the minimum required for continuous operation and for communication. The degree to which the position is organized is

determined generally by the proximity of the enemy and the length of time the post is to be occupied.

e. A radio dismounted from a vehicle, supplemented by visual signals, messengers, and wire, may be used for communication. Radio is used sparingly to lessen the possibility of interception and the danger of disclosing the position to the enemy.

31. EFFECT OF TERRAIN AND WEATHER. α. Operations of the reconnaissance troop are affected greatly by terrain. Open terrain affords good observation and favors vehicular movement across country. Wide zones are covered in dispersed formations. Thorough reconnaissance can be conducted at a maximum rate. Difficult terrain canalizes movement, favors the use of obstacles by the enemy, and increases the possibility of ambush. The width of zones is reduced and units advance with increased caution. Dismounted reconnaissance may be required frequently. Heavily wooded or broken terrain may limit observation and may restrict vehicular movement to roads. Natural obstacles such as hill masses, bodies of water, and dense woods may require time-consuming passage or wide detour.

b. The troop commander assigns zones, routes, or axes after careful estimate of the terrain to be covered. The estimate is based on detailed map study when the troop operates on unfamiliar terrain. The composition of reconnaissance teams and initial formations are determined. They are modified subsequently with variations in terrain.

c. Rain and fog require reconnaissance teams to operate at reduced distances and intervals since control is difficult. Observation is limited. Frontages are narrowed and the rate of advance is reduced. It may be necessary for dismounted men to precede vehicles.

d. Extremes of temperature may require relief of personnel more frequently and increased maintenance of vehicles.

32. NIGHT RECONNAISSANCE. α. Reconnaissance is slow and less effective at night. Motors are audible for con-

siderable distances and observation is difficult. Night reconnaissance is limited ordinarily to dismounted patrolling, observation of routes, and the use of listening posts.

b. Night reconnaissance is planned carefully after detailed map study. Reconnaissance of routes is made in daylight where practicable. Each unit leader prepares a sketch showing the route to be followed, the road net of the area, landmarks which can be recognized easily at night, compass bearings for major changes of direction, and distances from the initial point to prominent landmarks along the route.

c. Patrol leaders check equipment prior to departure to insure that it is muffled. Radio dial lights are masked.

d. Definite means of identification and methods of signaling are determined. Shielded colored flashlights and audible signals may be used for identification and to transmit prearranged messages. Such signals must be varied. Plans for control are simple and definite. Assembly points are designated in localities which can be found readily in darkness.

e. Units move to successive objectives by bounds. The degree of caution with which the advance is made is determined by the known or suspected proximity of enemy forces. Dismounted patrols precede vehicles by bounds when the enemy is believed to be near. The length of each bound is limited by the range of the method of signaling used.

f. Halts are made in positions where approaching men and vehicles are outlined against the sky, and dismounted men are posted at sufficient distance that sounds can be heard above the noise of engines. Engines which can be started quietly may be stopped at halts.

33. RECONNAISSANCE OF ROADS. **α.** Reconnaissance of roads is conducted to determine whether or not a particular route is being used by the enemy or is usable by elements of the division. Route reconnaissance is both tactical and technical. Technical route reconnaissance within the division area is the responsibility of the engineer battalion. Engineer recon-

naissance elements are attached to the reconnaissance troop or accompany the troop when technical reports on the condition of roads are desired. However, any condition along routes which may affect the tactical employment of the division is reported by the reconnaissance troop.

b. A road is observed by leading elements from successive observation points off the road. Detailed investigation of the roadway is accomplished by rear elements, or by leading elements when they have determined that the road is clear of enemy. Elements advancing on the road adopt formations which provide security, and offer poor targets to hostile fire. Dismounted patrolling may be employed to supplement observation from vehicles. Careful examination is made of areas in and adjacent to the roadway favorable for the use of mines.

34. RECONNAISSANCE OF TOWN. **α.** A town is approached from a flank or from the rear. Detailed reconnaissance with field glasses precedes mounted reconnaissance around the town when time and the terrain permit. A dismounted patrol enters the town for detailed reconnaissance. The remainder of the unit takes position to cover an exit. Care must be taken by the patrol to avoid being trapped within the town by hostile forces.

b. Patrols move cautiously within a town. Detailed observation is made from covered positions. Rear elements protect the advance of forward elements.

c. The patrol moves along streets with a single file on each side. Individuals move close to buildings, halting in doorways or behind other suitable cover to observe windows, cellar gratings, and roofs on the far side of the street. Streets and intersections are crossed by individuals in a single bound. When the patrol is fired upon, men take cover. Reconnaissance is made to determine the location, composition, and strength of the enemy.

d. When vehicles follow a dismounted patrol through a town,

they advance by bounds along routes which have been reconnoitered by the patrol. They move in staggered formation close to buildings. Intersections and other critical localities are designated as successive objectives. Men in vehicles are alert. Vehicular weapons are manned where personnel is available. They are sited at halts on positions favorable for enemy snipers.

35. RECONNAISSANCE OF OBSTACLES. *a.* The leading vehicle moves cautiously when approaching defiles where obstacles could be used by the enemy to advantage. Vehicles are halted in covered positions and reconnaissance of the defile is conducted dismounted. Automatic weapons and antitank guns are sited to cover patrols. A search is made for evidence of mines, demolitions, and barricades. The area is examined carefully for trip wires. Convenient routes around obstacles are apt to be mined.

b. When an obstacle is discovered, it is reported promptly to the unit leader. Patrols are sent beyond and to the flanks to locate defenders. Enemy strength and dispositions are determined. Reconnaissance is made for routes by which the obstacle can be avoided. The unit leader determines a plan of action and reports to higher headquarters. Unless subsequent action is directed by higher headquarters, the unit leader proceeds on his mission (pars. 27, 28, and 36).

36. RECONNAISSANCE OF A BRIDGE OR DEFILE. Visual reconnaissance is made for enemy positions before leading elements of a reconnaissance unit cross a bridge (fig. 4). Dismounted patrols reconnoiter approaches. They precede leading vehicles across the bridge when ambush, mines, or booby traps are suspected (fig. 5). Elements in rear cover the crossing of leading vehicles and the reconnaissance of the far side. Vehicles in rear cross when the leading element has secured the far side. The passage of a defile is conducted in a similar manner.



Figure 4. Prior to crossing a bridge or passing through a defile, a commanding point is gained from which visual reconnaissance may be made.

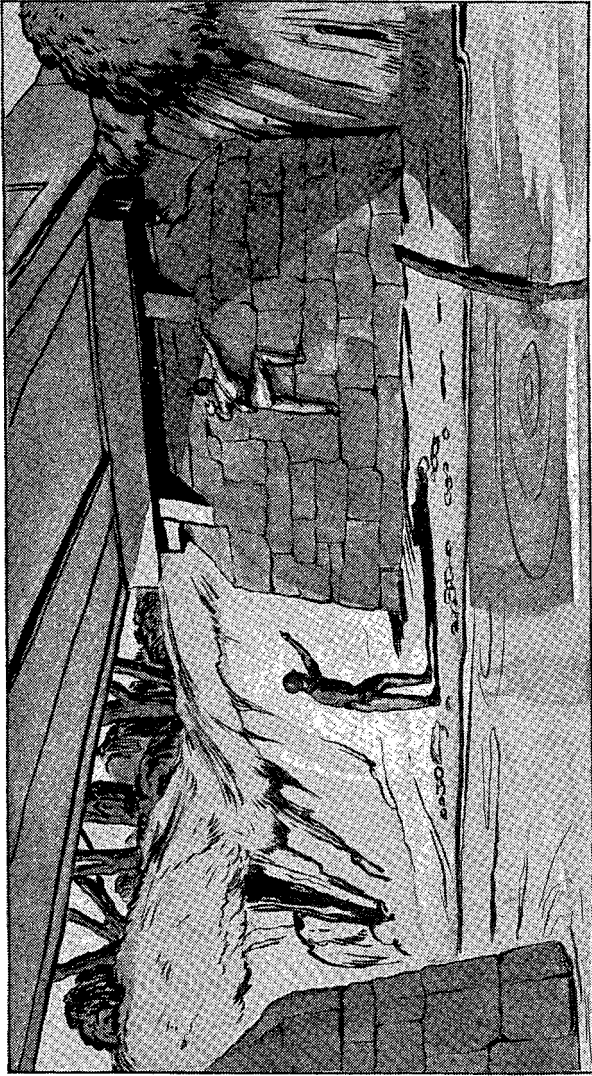

Figure 5. Bridge reconnaissance includes inspection for booby traps, mines, or demolition charges, and purposely weakened construction.

37. RECONNAISSANCE OF HOSTILE CAMP, BIVOUAC, OR INSTALLATION. Hostile camps, bivouacs, or installations are approached from the flank or rear by dismounted patrols. Vehicles are concealed at a distance. Information gained by patrols is sent by messenger to a command vehicle for transmission. Enemy security measures (fig. 6) may necessitate distant observation in daylight and the use of listening posts at night (par. 30).

38. RECONNAISSANCE OF HOSTILE COLUMN. a. A moving column is reconnoitered from a flank. An observation post is established where terrain and visibility are favorable, or dismounted patrols are sent to observe the enemy at close range. Information is sent by messenger to a command vehicle for transmission. A column at the halt which cannot be observed from a single position is reconnoitered by patrols moving to successive positions along a flank.

b. Patrols which have been cut off or surrounded may be able to continue observation of the enemy. They remain concealed in daylight and withdraw under cover of darkness, using routes determined and reconnoitered previously.

Section III

Security

39. GENERAL. The reconnaissance troop or any element of it acting alone is responsible for its own local security. The troop contributes to the security of the division by reporting the location of enemy forces and by giving timely warning of ground and air attacks. Information and warnings are transmitted to higher headquarters and directly to units whose security is threatened.

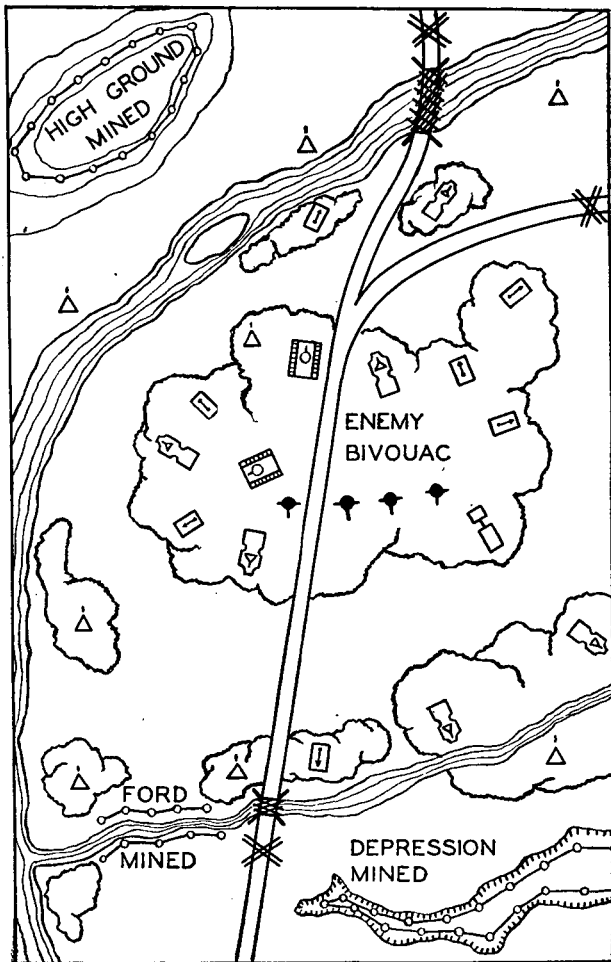

Figure 6. Reconnaissance of hostile bivouac. It can be expected that roads, bridges, likely observation points, and positions offering concealment for vehicles will be mined, obstructed, and covered by emplaced weapons. Bridges will be prepared for demolition.

40. SECURITY ON RECONNAISSANCE. **α.** The search for information of the enemy provides the greatest measure of security for the troop on reconnaissance. Crews observe constantly while vehicles are in motion. Distance and interval are maintained between moving vehicles, preferably not less than 100 yards. Teams and platoons move by bounds with vehicles constantly in position to support the advance of preceding vehicles. Covered routes are used where available. Dangerous positions to the flanks are reconnoitered before the bulk of the team or platoon arrives within effective range. Mounted patrols sent beyond visual range include at least two vehicles for mutual support.

b. Observers are posted at halts to provide timely warning of approaching aircraft and ground units. Vehicles are dispersed. Maximum use is made of available cover, concealment, and natural obstacles.

c. Air scouts are designated specifically. Upon the approach of aircraft, moving vehicles are dispersed and concealed. Men take cover. They do not fire at aircraft unless ordered by commanders. Orders to fire are not issued unless planes attack.

d. The principles to be observed are illustrated in figures 7 to 17, inclusive. See also paragraphs 44 and 45.

41. SECURITY ON MARCHES. When the troop marches as a unit, security detachments are employed to the front, flanks, and rear. The strength of detachments is the minimum consistent with security. Advance, flank, or rear guards for the troop should not exceed three-vehicle reconnaissance teams unless contact with the enemy is imminent (fig. 18). When the troop marches cross country, a covering detachment composed of a platoon or a reconnaissance team is used.

42. SECURITY AT HALTS AND IN BIVOUAC. **α.** When a reconnaissance team or platoon halts, a march outpost is established to provide security. Vehicles are dispersed and concealed. Sentinels are posted at sufficient distance to give timely



Figure 7. All movement should be cross country unless the terrain prevents it.

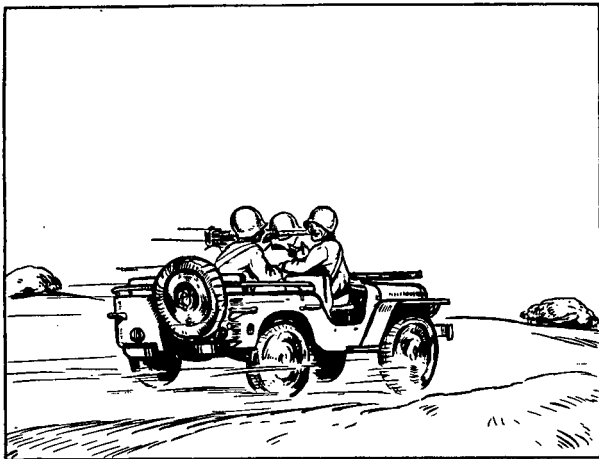

① *Wrong.*

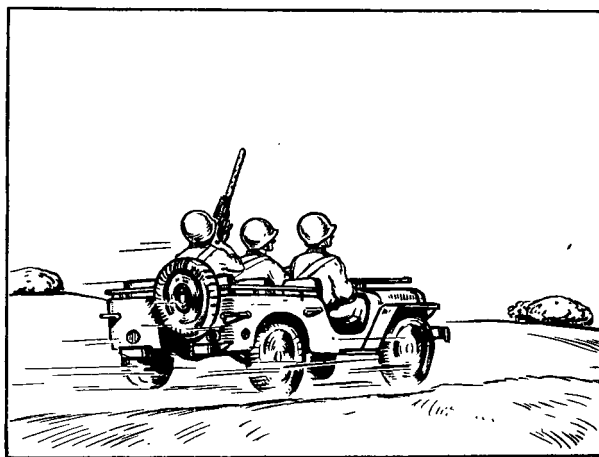

② *Right.*

Figure 8. *Anti-aircraft weapons are alerted for anti-aircraft fire at all times.*

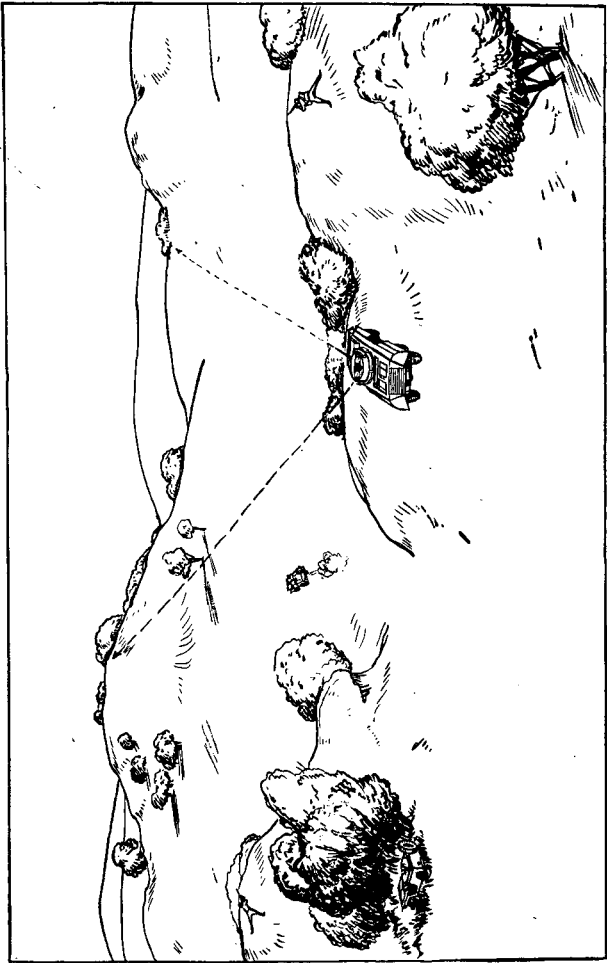

Figure 9. When advancing in the presence of the enemy, place vehicles in position to support the advance of the leading vehicle.



① *Wrong.*



② *Right.*

Figure 10. Do not advance in front of a light background; use dark background to cover advance,

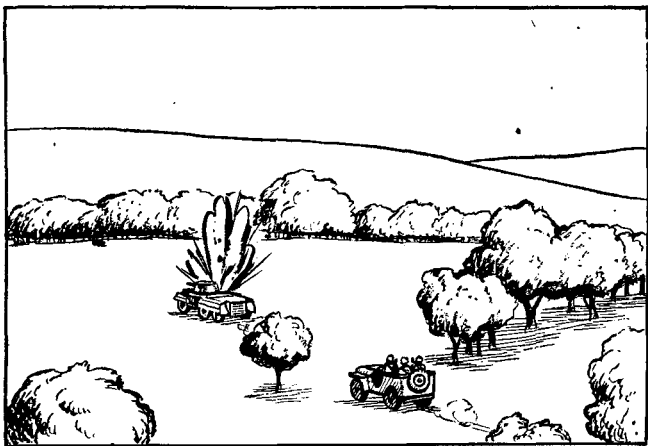

① *Wrong.*

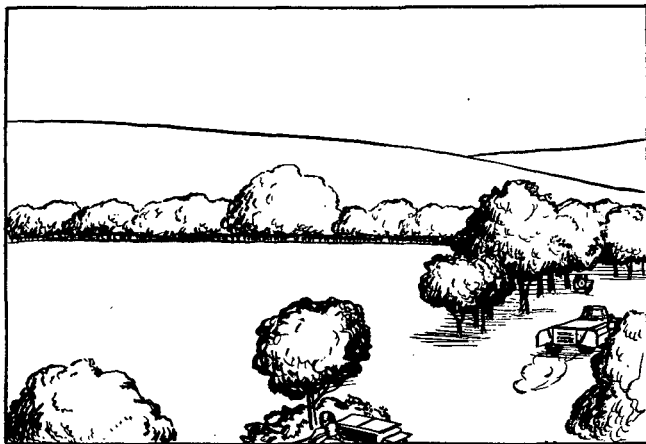

② *Right.*

Figure 11. Do not take a short cut through open fields. Go around in order to advance under cover.

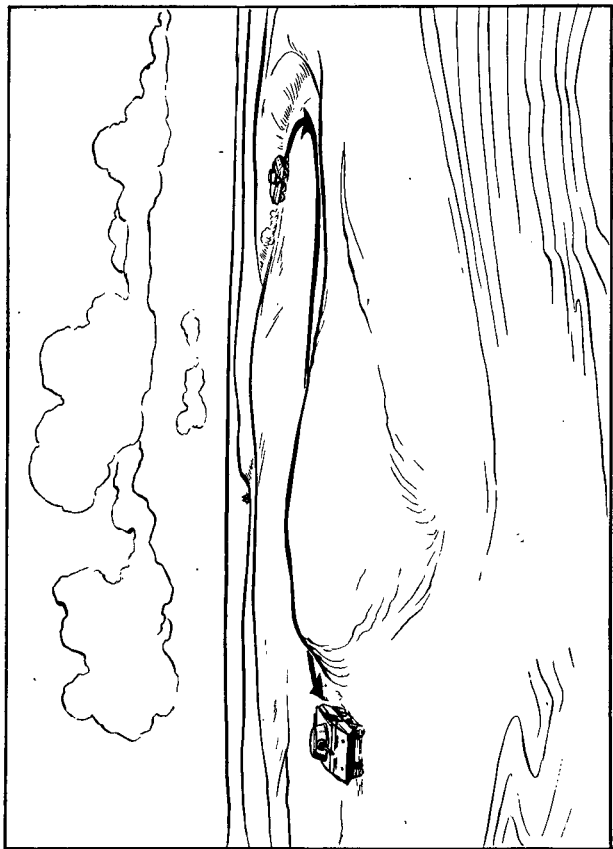
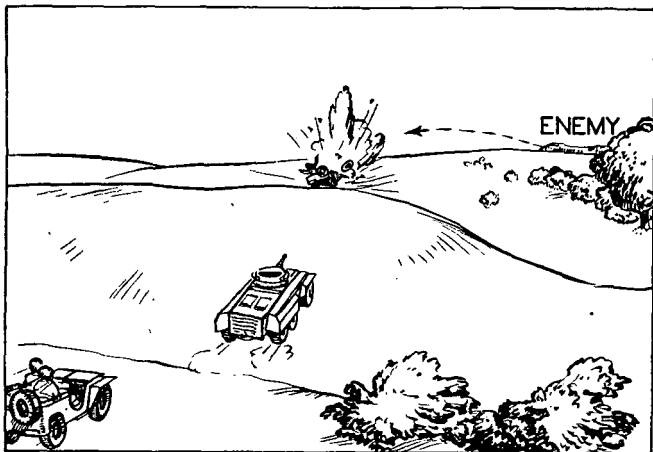
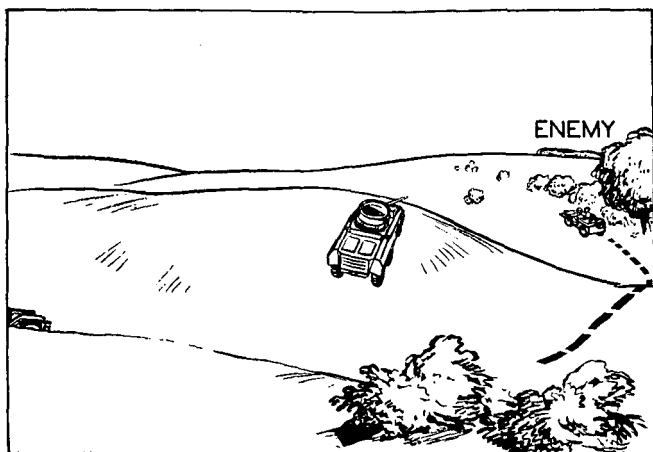

Figure 12. In open terrain, vehicles advance from fold in the ground to fold in the ground, taking every advantage of the terrain to reduce exposure to enemy fire.



① *Wrong.*



② *Right.*

Figure 13. Do not cross a treeless ridge when it can be avoided; make use of the ridge as cover for a change of approach direction.

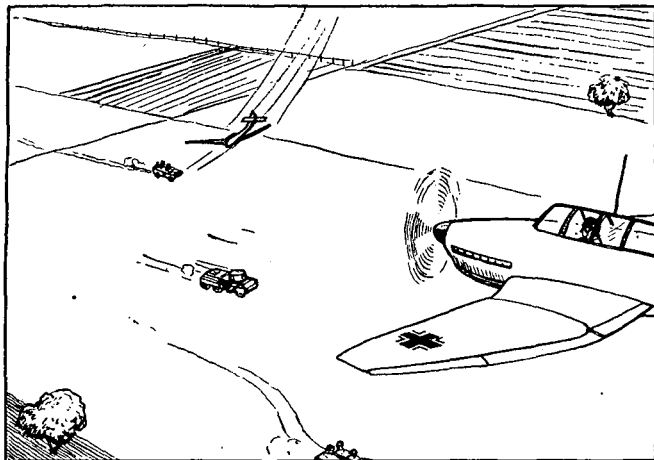

① *Wrong.*

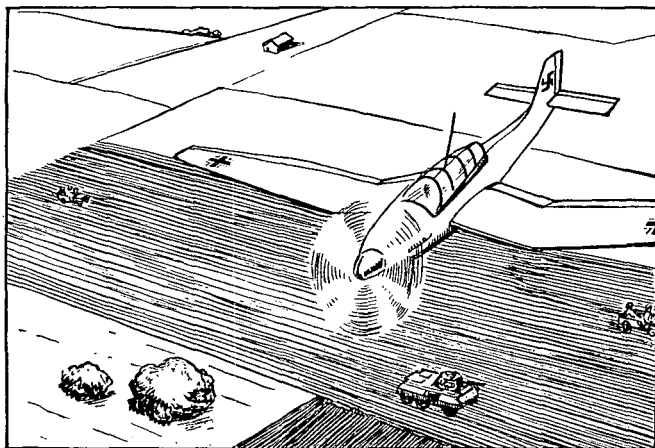

② *Right.*

Figure 14. Do not drive over a light-colored field when it can be avoided. Use dark background for movement as far as possible.

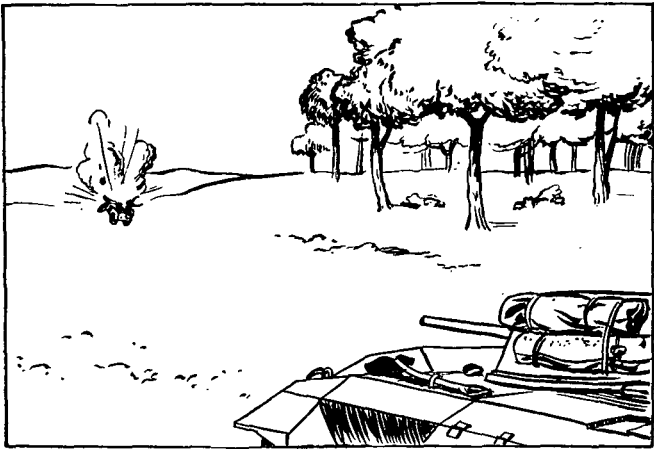

① *Wrong.*

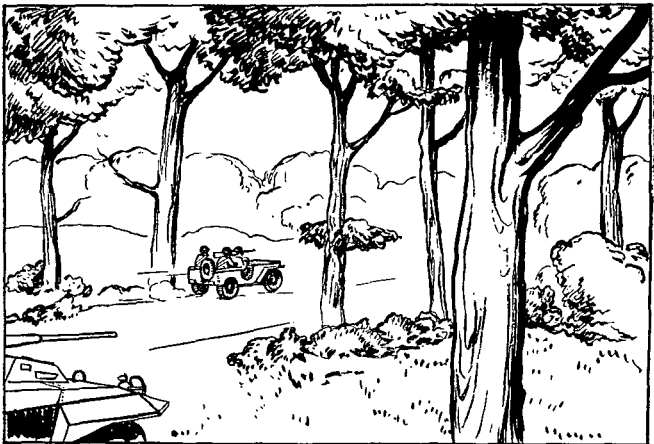

② *Right.*

Figure 15. Do not drive by wooded areas; use the woods for concealment.

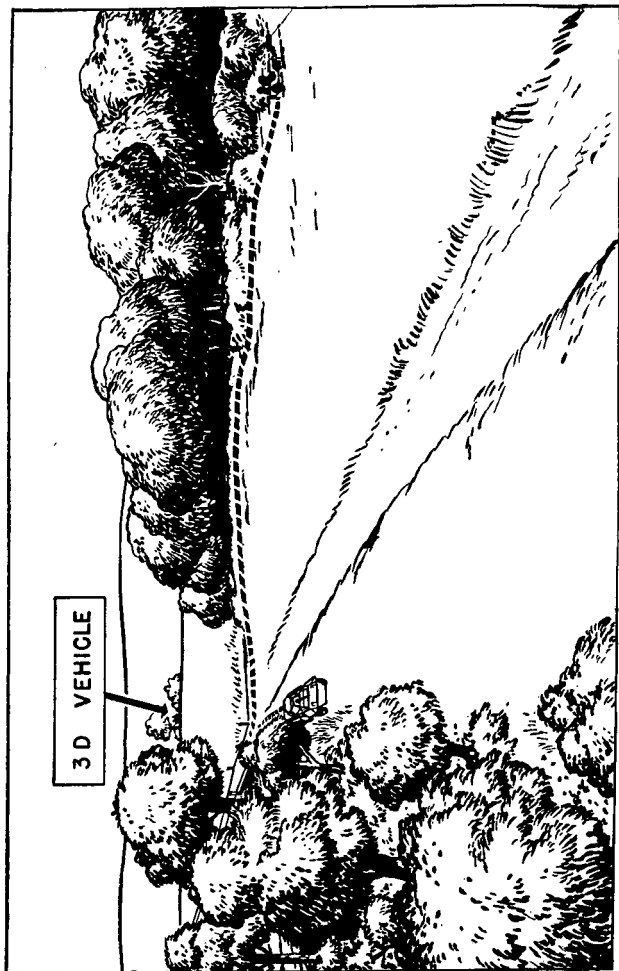

Figure 16. Spread out as soon as you clear a defile; patrol is less vulnerable to enemy fire; fire of rear vehicles is not masked.



Figure 17. Supplement vehicular reconnaissance with dismounted patrolling.

warning of the approach of hostile aircraft or ground forces. Vehicular weapons are manned. Reconnaissance elements observe the principles illustrated in figures 19 to 31, inclusive.

b. When the troop bivouacs, an outpost is established. Troops may be drawn from the support platoon. The outpost is no stronger than is consistent with security. Barriers provide additional security. A bivouac is reconnoitered and selected in daylight, but occupied after dark to prevent observation by the enemy. Bivouac areas must be large enough to permit vehicles to disperse under cover, and must have at least two exits. Principles to be observed in establishing and operating outposts are illustrated in figures 32 to 35, inclusive.

(1) Vehicles are disposed within the bivouac area so that their weapons furnish all-around protection. Vehicles are concealed from ground and air observation and are faced toward a route of departure. At least two routes of departure which have been reconnoitered are designated for use. Crews bivouac near their vehicles. One member of the crew of each vehicle on the perimeter of the bivouac should be awake at all times. Prone shelters are dug by all personnel for protection against hostile air attack and artillery fire. Mortars are emplaced and alternate positions are selected. Automatic weapons are sighted and half loaded. Range cards are prepared for mortars, 37-mm guns, and automatic weapons.

(2) Sentinels are posted to cover routes of approach. Mines and warning devices supplement the outpost line. A radio-equipped $\frac{1}{4}$ -ton truck may be sent to a distant point to provide observation and warning of enemy approach.

(3) Each sentinel is given the following information:

(a) Routes of approach to the bivouac he is to observe.

(b) Names of terrain features such as roads, villages, or streams in his area.

(c) Location of the main body and of adjacent outguards.

(d) Number of friendly patrols operating in the vicinity, and the direction and time of their expected return.

(e) Instructions concerning challenging.

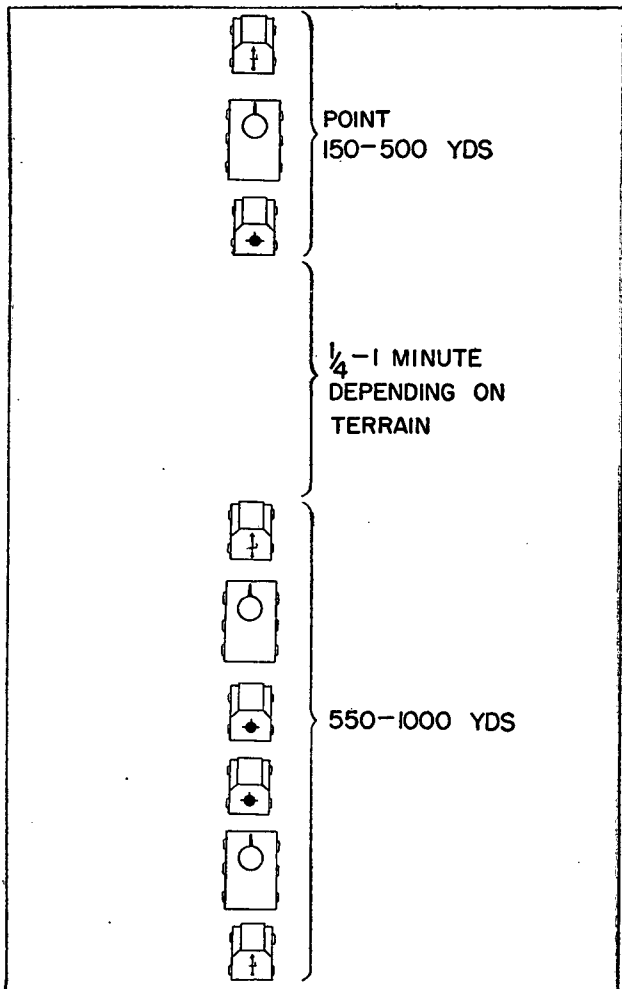

Figure 18. Platoon as an advance guard for the troop.

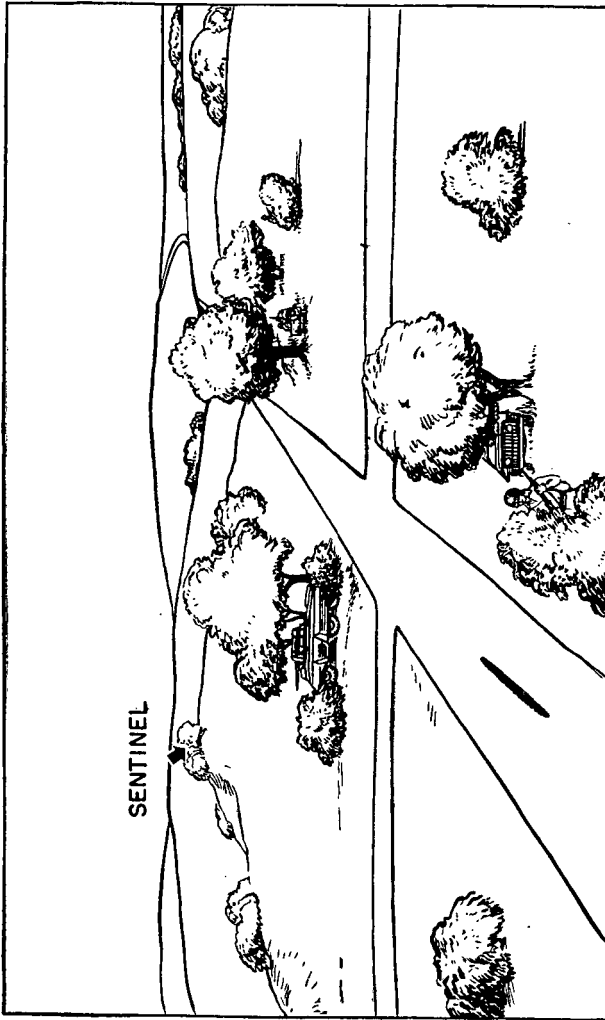

Figure 19. When a reconnaissance team halts, it immediately forms a march outpost providing all-around security.

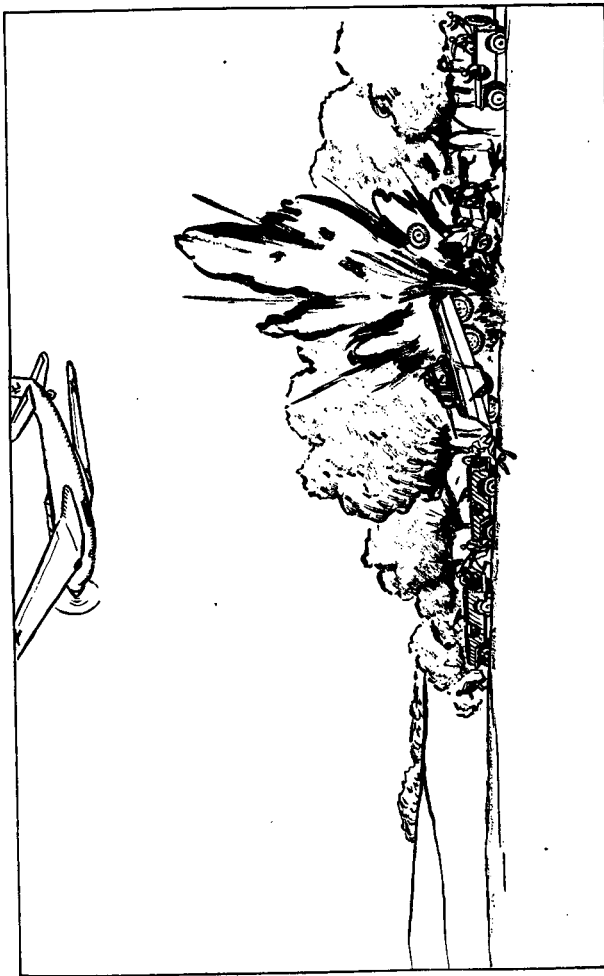
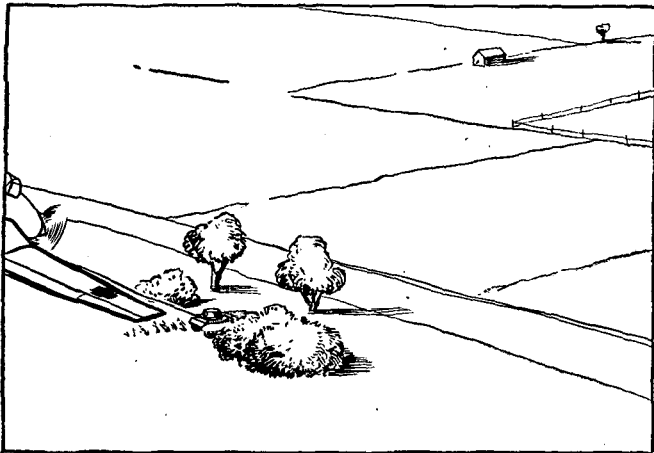
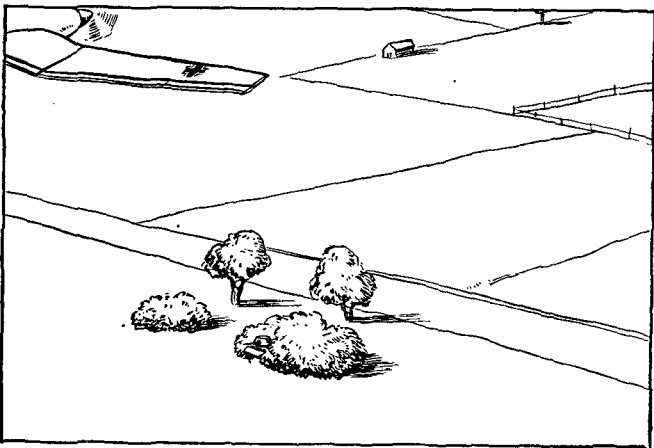

Figure 20. Do not close up during a halt. Halt with proper march distance so as not to present a massed target.



① *Wrong.*



② *Right.*

Figure 21. Do not halt in the open between bushes. Drive into bushes, leaving vehicle with good field of fire but difficult to recognize from the air.

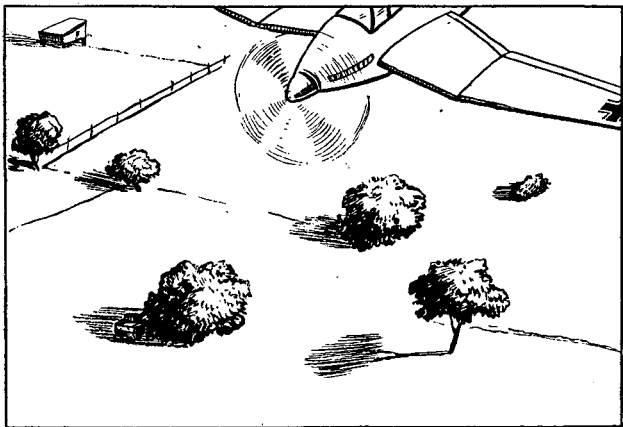
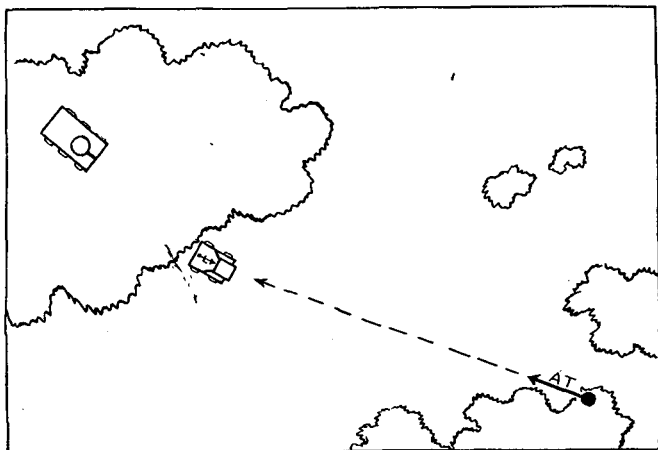
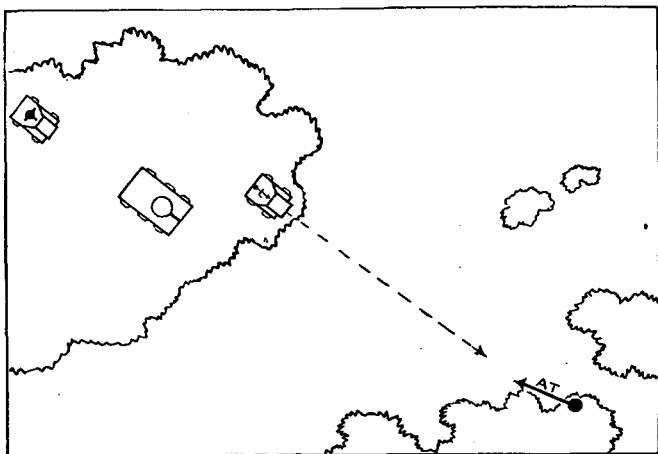

Figure 22. Use shadow of trees when halted. Halt on shady side of a woods' edge, not on the sunny side.



① *Wrong.*



② *Right.*

Figure 23. Do not halt outside the edge of a woods. Halt as deep in the woods as observation permits, utilizing as much cover as possible.

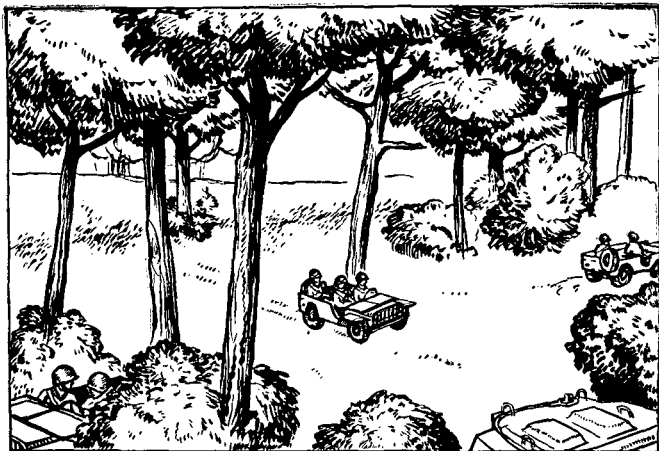

① *Wrong.*

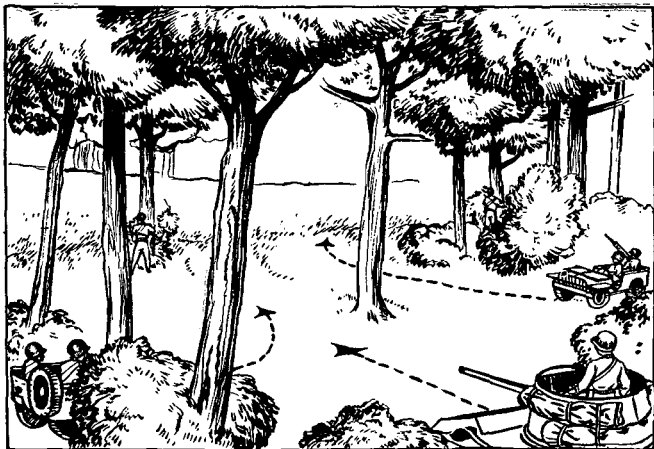

② *Right.*

Figure 24. Do not halt so vehicles will have to back to move out. Head vehicles so they can be moved forward. Turn turrets so AT guns will give all-around protection.



① Wrong.



② Right.

Figure 25. Do not remain in turret when moving into concealment; dismount and assist driver by signaling direction.



① *Wrong.*



② *Right.*

Figure 26. Place vehicles at least 50 yards apart. Face them so they can move out readily. Take advantage of concealment.



Figure 27. Keep vehicle crews in shade and under cover. Avoid movement in the open.

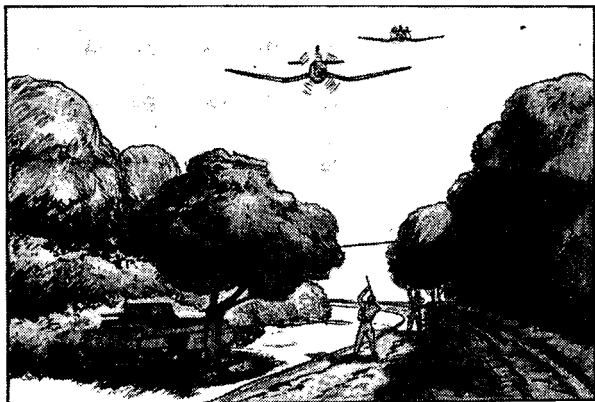

① *Wrong.*



② *Right.*

Figure 28. Do not fire at hostile planes unless fired on; they may not locate you.

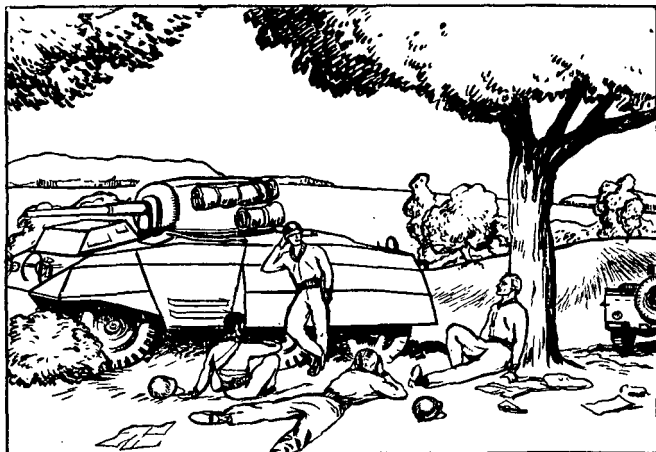

① *Wrong.*

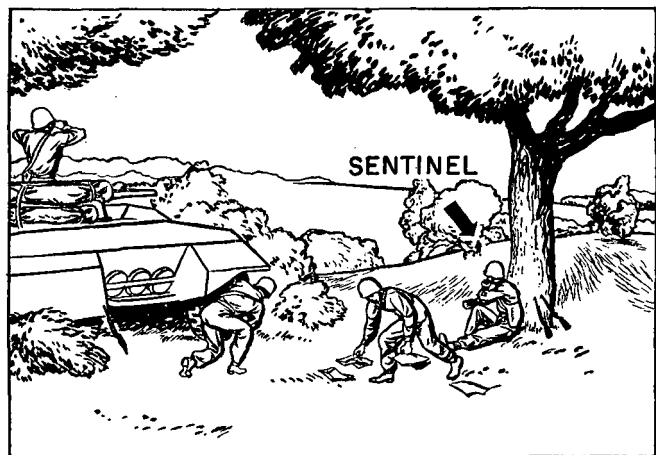

② *Right.*

Figure 29. Do not allow men to loaf at the halt. Inspect vehicles; keep at least one gun manned; keep observer alert; police halt site before continuing.

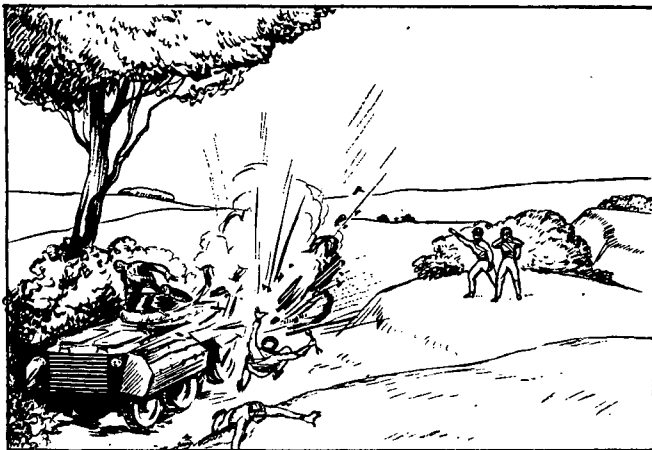

① *Wrong.*

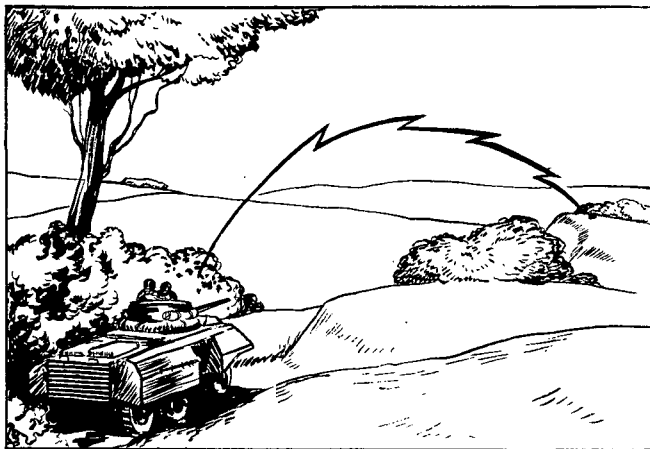

② *Right.*

Figure 30. Do not expect scouts close in to give adequate warning of mechanized attack. Post warning detachments well out.

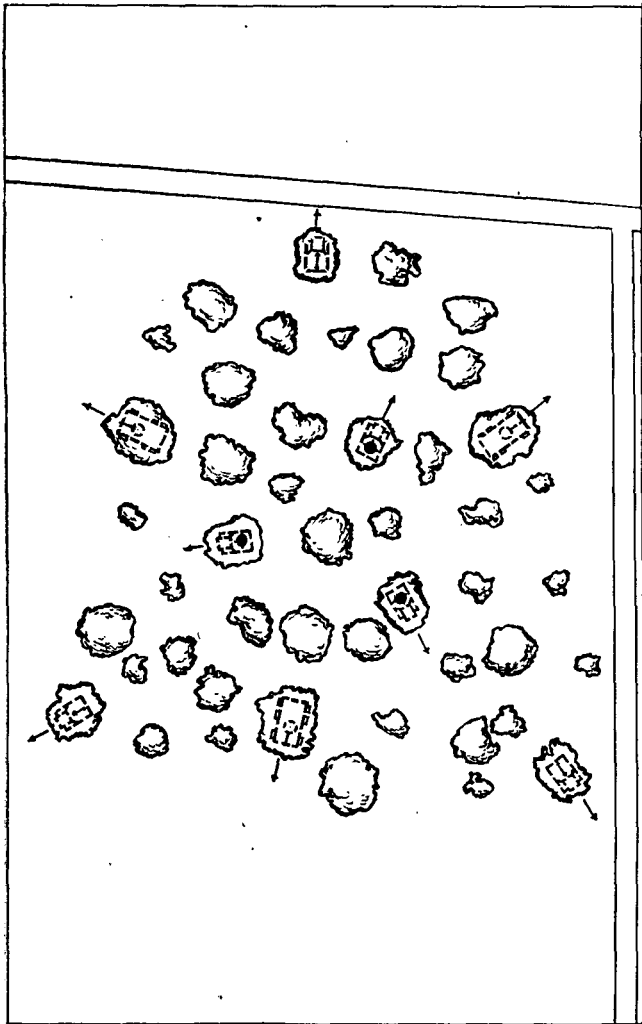

Figure 31. Disposition of vehicles of reconnaissance platoon to provide maximum security.

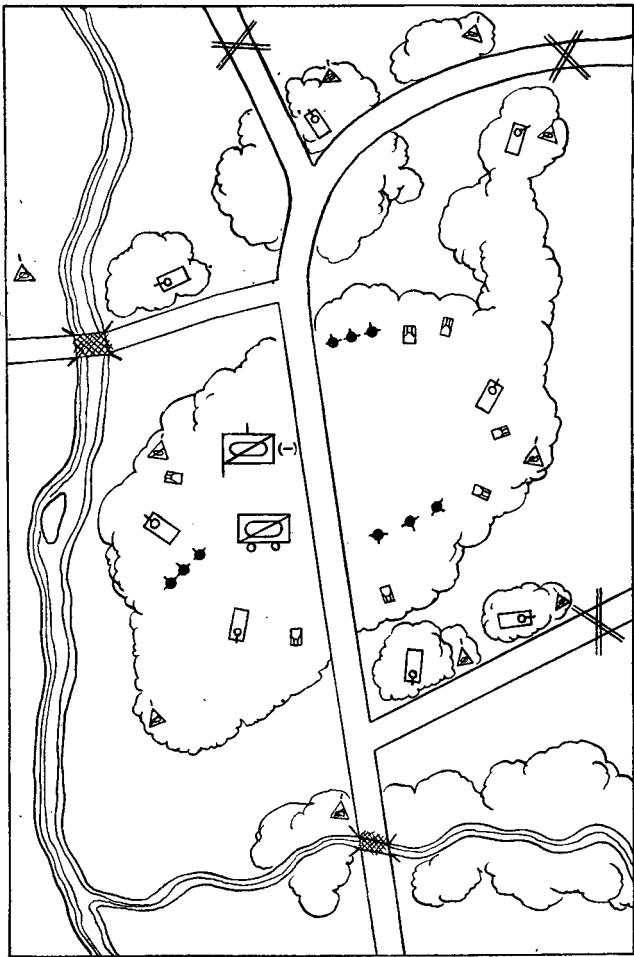

Figure 32. Organization of troop outpost. Cover avenues of hostile approach. Place train in center for greater protection. Use obstacles. Prepare bridges for demolition. Place mortars to cover approaches. Post observation groups.

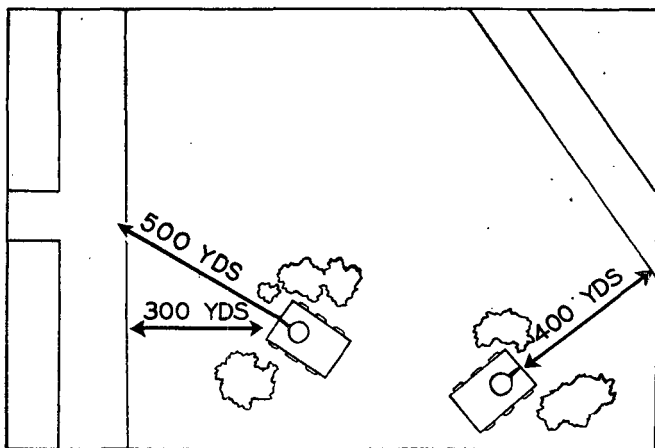
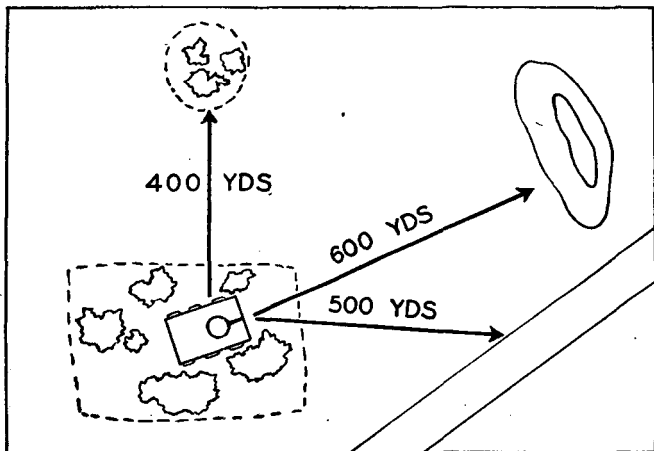
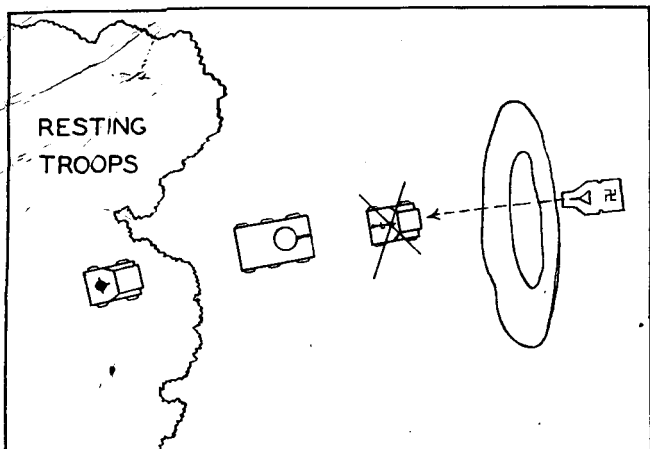
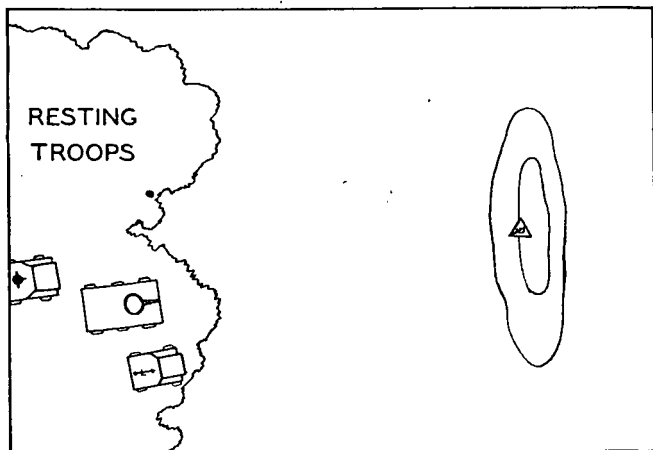

Figure 33. Vehicles on outpost are placed to block avenues of approach by fire. Ranges to important terrain features must be determined at once.



① *Wrong.*



② *Right.*

Figure 34. When the observation point is bare, keep vehicles under nearby cover. Send dismounted observer forward under protection of weapons.

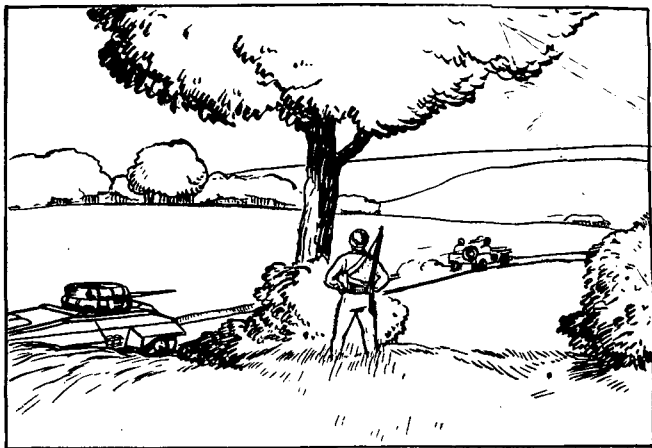

① *Wrong.*

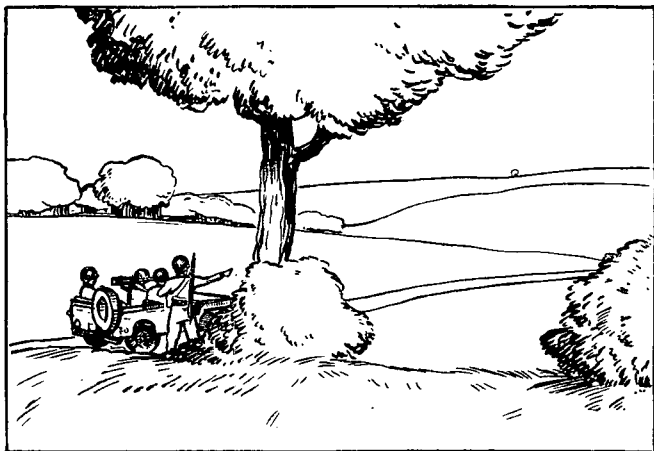

② *Right.*

Figure 35. Stop friendly vehicles traveling toward the enemy; ask the mission; explain the situation and location of your post.

(f) Signals to be used.

(g) Means of identification of friendly vehicles and personnel at night.

(h) Where messages are to be sent.

(i) When he is to be relieved and direction of withdrawal in case of attack.

(4) Sentinels force vehicles which attempt to pass through the outpost to stop. Methods employed should not cause damage to men or vehicles. Removable blocks may be placed across roads or trails which enter the outpost to cause vehicles to stop or slow down for challenging.

c. Contact between outguards is maintained by visiting patrols. A definite system of recognition must be prescribed.

d. The reconnaissance troop furnishes information and warnings of air and ground attack directly to the outpost of the division, as well as to division headquarters. The reconnaissance troop may be attached to the division outpost to perform reconnaissance missions.

43. SECURITY OF TROOP TRAIN. a. The troop train accompanies troop headquarters in an advance. The support platoon affords protection when present. Vehicles of the train are equipped with radio to provide communication within the train and with troop headquarters. Automatic weapons are provided on vehicles for anti-aircraft defense and rocket launchers for anti-mechanized protection.

b. When the train operates between supply points and the troops, the train commander provides security with organic means unless attachments are made by the troop commander. Personnel of all vehicles are alert for enemy air or ground activity. Information is transmitted to the troop commander by radio or messenger. The train commander, through prior map or road reconnaissance, must be prepared to change direction and route of march to avoid encounter with enemy forces. When warned of approaching aircraft, the train moves off the road, disperses, and halts, using available concealment to escape detection.

44. ANTI-AIRCRAFT SECURITY MEASURES. a. General.

The reconnaissance troop provides security against air reconnaissance and air attack employing measures for warning, concealment, dispersion, and fire. Antiaircraft security is prescribed in standing operating procedure (figs. 7 to 17, inclusive).

b. Warning. (1) Air scouts are designated in each vehicle to observe for hostile aircraft and give timely warning of their approach. On the march, they observe from the vehicles; at the halt, they are posted nearby. Security detachments are provided with signaling equipment if posted beyond visual range. All individuals are trained in the identification of hostile aircraft (FM 30-30). Air alarm may be transmitted by radio, visual signals, prescribed whistle signals, firing of weapons, or voice.

(2) Units and individuals are governed by the following rules, upon receipt of the air alarm warning:

(a) When in column, all vehicles seek cover, or disperse if no cover is available, and halt.

(b) Personnel in open vehicles not naming antiaircraft weapons dismount and disperse.

(c) Movement is resumed on command after airplanes have passed.

(d) Platoon and teams halt but do not fire at aircraft unless attacked, since they hope to avoid detection.

(e) Dismounted men seek cover and remain motionless.

(f) Orders to fire at aircraft are not issued unless planes attack. When fire is ordered, all suitable weapons are used.

(g) Men do not look up at aircraft during daylight or at night when flares are used, because faces are detected readily.

(h) It is important that movement cease when flares illuminate an area.

(3) Units over which enemy planes have passed should be alert for attack by combat aviation which may follow if the unit has been discovered.

c. Concealment. (1) The presence of troops is disclosed to an air observer by movement, regular formation or outline, reflection of light, dust, smoke, fresh tracks, and new installations. Measures taken for concealment aim to defeat visual reconnaissance and photography. Concealment is not effective unless complete. Constant attention is required for effective camouflage.

(2) Natural concealment requires less time, skill, and material, and is more effective than camouflage. Vehicles are concealed under heavy natural cover, such as dense woods. In partly open country, they should be driven into woods or brush. (TF 5-646, 5-648, and 5-649.)

(3) If natural concealment is not available, vehicles halt on broken ground. Natural or artificial means are used to camouflage their natural outline.

(4) Camouflage should appear natural. Tree branches, brush, weeds, leaves, grass, or dirt are used to cover matériel that is partially or wholly exposed. Regularity of pattern, angles, and shadows must be avoided. (FM 5-20.)

(5) Care must be taken that tracks do not disclose the location of vehicles. Tracks may be obliterated for short distances by sweeping or by covering them with brush or leaves. Paths made within a bivouac area are concealed from air observation.

(6) Open fires and unshielded lights should not be permitted. Smoke may disclose the location of a bivouac during daylight.

d. Dispersion. Vulnerability to air observation and attack is lessened by dispersed formations. Dispersion may be accomplished by increasing width and depth of formations, by moving in multiple columns, by distributing units in small groups within bivouac areas, and by halting vehicles at extended distances. The troop should have a prearranged system for dispersion in the event of air attack.

45. ANTIMECHANIZED SECURITY MEASURES. α. Mobility and skillful use of cover and concealment are the

principal means of security against mechanized forces. Warning service, similar to that provided for antiaircraft security, is established.

b. Advantage is taken of natural obstacles, such as streams, lakes, marshes, thick woods, and mountainous country, which restrict enemy mechanized operations. Artificial obstacles, such as barricades, ditches, demolitions, and mines, provide additional security for bivouac areas.

c. When the troop defends against mechanized forces, fire of organic weapons is employed. The 37-mm guns with which armored cars are equipped are effective against most tanks at ranges up to 400 yards and against lightly armored vehicles up to 1,000 yards.

46. SECURITY AGAINST CHEMICALS. For security against chemicals, see FM 21-40 and 100-5.

47. COUNTERRECONNAISSANCE. The troop is employed on reconnaissance when assigned to a larger force on a counterreconnaissance mission, and is used to locate and maintain contact with enemy patrols (pars. 27 to 29, incl.). Combat is avoided. The composition, location, and direction of movement of enemy patrols are reported promptly.

Section IV

Combat

48. OFFENSIVE COMBAT. **a.** The troop or platoon engages in combat with enemy forces which threaten the success of the mission. Elements support each other by employing fire and maneuver to effect the advance of the unit; or, a part of the unit contains the enemy while the remainder continues on the mission. The unit does not become involved so seriously that it cannot withdraw to secure freedom of action for

an advance in a new direction. In side-slipping hostile resistance, the detour is made beyond the effect of enemy weapons, so that the enemy must displace to offer further resistance.

b. A reconnaissance unit may encounter a defended obstacle which must be reduced in order to accomplish the mission. The unit attacks when reconnaissance indicates that the enemy position can be taken with the means available. Reinforcements are requested promptly when reconnaissance indicates enemy strength beyond the capabilities of the unit. Surprise, speed, and coordination are essential in the attack. The defenders must be located accurately, pinned by fire, and enveloped.

49. OBJECTIVES. When on reconnaissance, the troop or its elements attack limited objectives only. Vital observation points or other terrain features essential to the mission may be seized, and the defended obstacles or enemy forces which threaten the success of the reconnaissance mission may be attacked.

50. TACTICAL GROUPINGS. **a.** The reconnaissance troop engages in offensive action as a unit exceptionally. Platoons attack to accomplish assigned missions. The troop coordinates the action of platoons and directs the action of attached units. In an attack, three tactical groupings are formed: a base of fire, a maneuvering force, and a support.

b. The base of fire pins the enemy to the ground and neutralizes his weapons to assist the maneuvering force in reaching a position from which to assault. Weapons selected to form the base of fire are determined by the type of targets presented by the enemy and the availability of covered positions for armored cars and mortars. Elements of the base of fire displace to advanced positions when fire superiority is gained. Under favorable conditions, they may gain positions from which to participate in the assault.

c. (1) The maneuvering force moves by a covered route to a position from which to attack the enemy flank or rear. Move-

ment is made in vehicles where practicable. Armored cars may be included where conditions favor the employment of their armament.

(2) The movement is protected by a covering force. Movement in vehicles terminates at the last available cover. The force continues dismounted in an approach march formation until compelled to fire in order to advance. Fire is opened on orders of the commander.

(3) Fire superiority is gained over the enemy by subjecting him to fire of such accuracy and intensity that hostile fire becomes inaccurate or decreased in volume. The base of fire assists in neutralizing enemy fire.

(4) Advances are made by infiltration and by successive rushes and maneuver of small groups. The movement of advancing elements is covered by the fire of those remaining in position. Groups push forward during each lull in enemy fire to occupy successive firing positions. The combination of fire and movement enables attacking elements to reach positions from which they can employ grenades and overcome the enemy in hand-to-hand combat.

d. A support is withheld initially. The support for the troop or platoon should not exceed a platoon or team, respectively. It is committed at the proper time and place to assure victory. After an attack is launched, the support is the principal means available to the commander to influence the action. Prior to being committed, it protects the flank and rear. It is held until the decisive moment and committed as a unit. Other uses are to cover reorganization on the objective, to initiate limited pursuit, or to cover a withdrawal. The support commander maintains contact with the unit commander.

51. EMPLOYMENT OF WEAPONS. α. General. The troop can deliver heavy fire with mortars, antitank guns, and automatic weapons. The variety of weapons with which the troop is equipped permits the assignment of proper weapons to engage particular targets.

b. Individual weapons. Each man is armed with a rifle, carbine, or submachine gun. He carries his weapon whenever he is dismounted from the vehicle. Grenades are carried in vehicles for issue to individuals when required.

c. 37-mm gun. The 37-mm gun has a high muzzle velocity and flat trajectory. It is effective against most tanks at ranges not exceeding 400 yards when armor-piercing ammunition is used. Armor-piercing ammunition is effective against lightly armored vehicles at ranges less than 1,000 yards. High explosive ammunition is used against machine guns and anti-tank weapons. Canister is effective against personnel at ranges less than 200 yards. The gun is employed from positions which afford hull defilade for the armored car (fig. 36). No ground mount is provided for the 37-mm gun. Fire from a moving vehicle is inaccurate.

d. Machine gun. The caliber .30 machine gun is a flat trajectory weapon capable of delivering a relatively high volume of fire. It is primarily an antipersonnel weapon. Caliber .30 armor-piercing ammunition is effective against lightly armored vehicles at close range. The gun may be fired from the vehicle or from the ground (fig. 37). Fire from a moving vehicle is inaccurate.

e. 60-mm mortar. The 60-mm mortar is a high-angle fire weapon for use against crews of enemy weapons, personnel grouped closely, and targets in defilade. Mortars of a platoon may be fired as a unit or individually. The mortar can be fired from the $\frac{1}{4}$ -ton truck or from the ground (fig. 38). Mortar fire must be observed and adjusted. Crews select primary and alternate positions habitually. Limiting ranges of the mortar are approximately 100 and 2,000 yards.

f. Rocket launcher. Rocket launchers are provided for antitank protection. They are effective also against buildings, machine-gun emplacements, and embrasures. The launcher has a relatively low rate of fire and a distinctive flash on discharge. It is inaccurate at ranges over 300 yards. It is a powerful supporting weapon at short ranges.

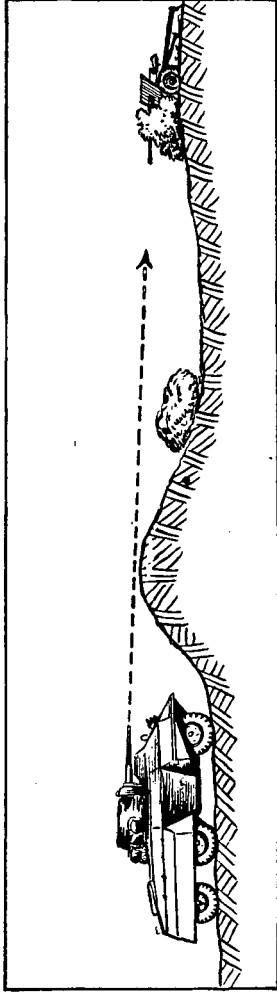
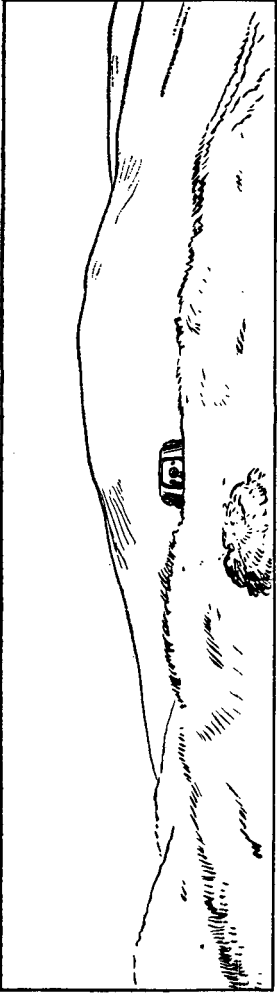

Figure 36. Armored cars seek positions offering hull defilade when firing.



Figure 37. Automatic weapons are set up on the ground when good vehicular positions are not available.

g. Ammunition. Because of the small amount of ammunition carried in each vehicle, economy must be exercised in its use. Use the proper weapon and ammunition. For example, use the 37-mm gun on targets against which other available weapons are ineffective. Strip disabled vehicles of ammunition whenever practicable. Platoon leaders check ammunition frequently and redistribute when necessary.

52. COORDINATION AND CONTROL. **a.** The commander coordinates the efforts of all elements employed in the attack. The following control measures are included in the attack order:

- (1) Mission.
- (2) Initial dispositions.
- (3) Direction of attack for each element.
- (4) Time of attack.
- (5) Objectives for each element.
- (6) Signals for lifting supporting fire.
- (7) Instructions for maintaining contact and for flank protection.
- (8) Initial location of the commander.

b. Reliable communications are essential for coordination and control during an attack. Orders must be clear and concise. Messengers, radio, and visual signals are used for communication. The commander observes from a forward position or accompanies the maneuvering force.

c. Where practicable, complete orders are issued orally to assembled subordinate commanders at a point from which the objective can be seen (fig. 39). Orders are delivered by radio or by messenger to leaders who are absent. Fragmentary orders may be issued when necessary.

53. REORGANIZATION. The unit reorganizes promptly when the objective is reached. Preparations are made to repel counterattack and to continue the mission. Duties of leaders during reorganization are—

- a.** To provide all-around security.

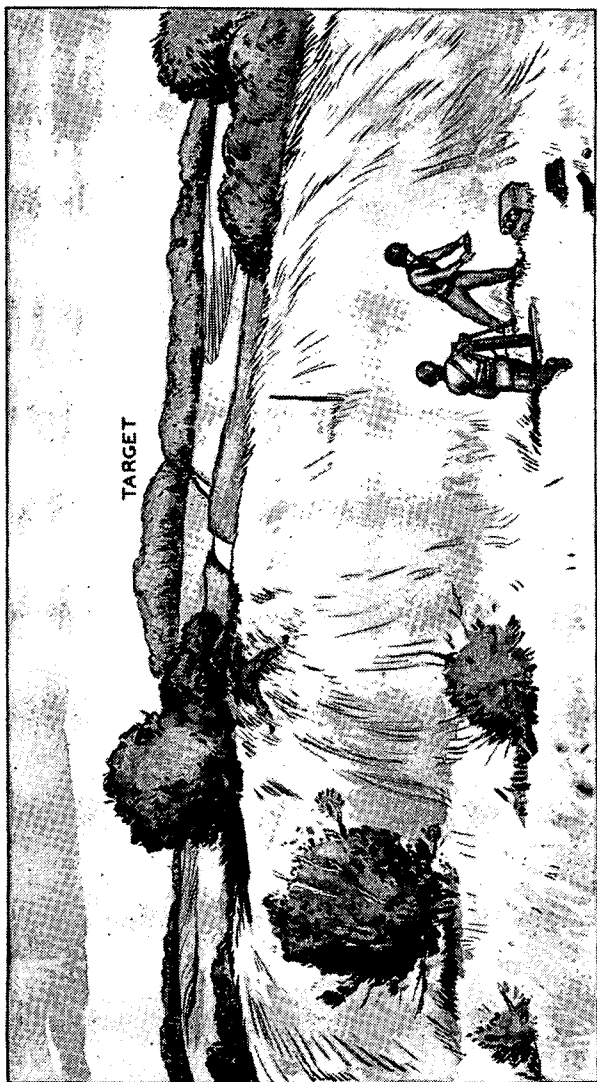

Figure 38. The mortar should be placed in a deflated position near good observation.



Figure 39. Do not give orders from a map or by description alone, if a position can be reached from which enemy and terrain may be pointed out.

- b. To replace leaders who are casualties.
- c. To reconnoiter to the front and flanks.
- d. To care for the wounded.
- e. To report the results of the action to the next higher commander.
- f. To redistribute ammunition.
- g. To send prisoners and captured documents to the next higher headquarters.
- h. To issue orders for future action.

54. DEFENSIVE ACTION. a. General. Elements of the reconnaissance troop may be required to defend observation posts, bridges, or defiles, in order to accomplish reconnaissance missions. Enemy attack may necessitate defensive action in other instances. The decision to defend a position rather than to conduct a delaying action should be made after weighing the advantage to be gained against the risk involved. The fire which can be delivered with concealed vehicular weapons, emplaced automatic weapons, and mortars compensates partially for inadequate personnel. Mobility is employed to gain information of the attacking forces, to maneuver supports, or to effect withdrawal. Defense of an isolated position by a small force exposes the unit to danger of being cut off and destroyed.

b. Defense of a position. Defense of an isolated position requires patrolling on all routes of approach, local security measures, organization of ground for all-around defense, and mobile supports available to occupy previously prepared positions or to counterattack. The position is organized to the extent that time permits. Fox holes and weapon emplacements are dug and camouflaged. Weapons are sited to cover approaches. Alternate and supplementary positions for weapons are selected and prepared. Close-in defensive fires are planned. Natural obstacles are improved and supplemented where practicable. Part of the position is occupied. Separate plans are made for employing the support to reinforce the position, extend the position, and to counterattack. Routes of withdrawal are reconnoitered.

c. Delaying action in successive positions. (1) A delaying action in successive positions is conducted by offering limited resistance only on each position. The unit is deployed on the broadest front which will permit control and mutually supporting fires. When a flank is exposed, a stronger support is retained. A position near the topographical crest is better generally than one on the military crest. The former affords the unit defilade immediately upon initiation of withdrawal. Fires are opened at extreme ranges in order to force the enemy to deploy and to make time-consuming preparations for attack. A natural barrier to enemy approach is desirable. Mines are placed if time permits. Early reconnaissance of successive positions and routes of withdrawal by all leaders is necessary.

(2) Withdrawal to a rear position is made before hostile fire can pin the unit to the ground and before the enemy can reach assaulting distance. Withdrawal can be made by elements successively or simultaneously. When withdrawing successively, units support one another's movement. When they withdraw simultaneously, each unit supports its own withdrawal (par. 55). Patrols maintain contact with the enemy between delaying positions.

d. Delay on one position. Elements of the troop may be required to hold a position for a predetermined time. A unit defending a single position to effect delay organizes the position and plans its fires as indicated in **b** above.

55. BREAKING OFF ACTION. A reconnaissance team or platoon breaks off action to side-slip enemy resistance, or to withdraw to secure freedom of movement. All elements do not withdraw simultaneously, since the enemy might have mobile forces with which to pursue. A small covering force, located in the rear or to a flank, covers the withdrawal. The remainder of the unit assembles in a position which is protected from direct fire, and assists the covering force to withdraw. Mines and demolitions are used to impede the enemy advance.

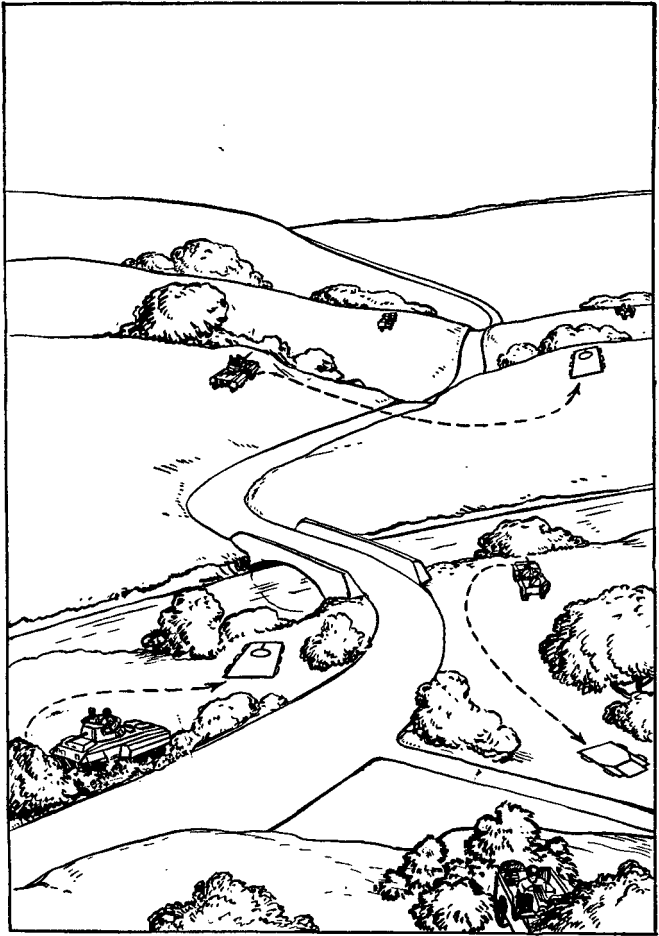

Figure 40. Hold key point by disposing vehicles to cover all directions. Send security detachments well out. Select alternate and supplementary positions for vehicles and weapons.



Figure 41. Place vehicles to fire on hostile vehicles at approaching ambush. Site machine guns and mortars to prevent hostile personnel from removing obstacle. Select alternate positions for all vehicles.

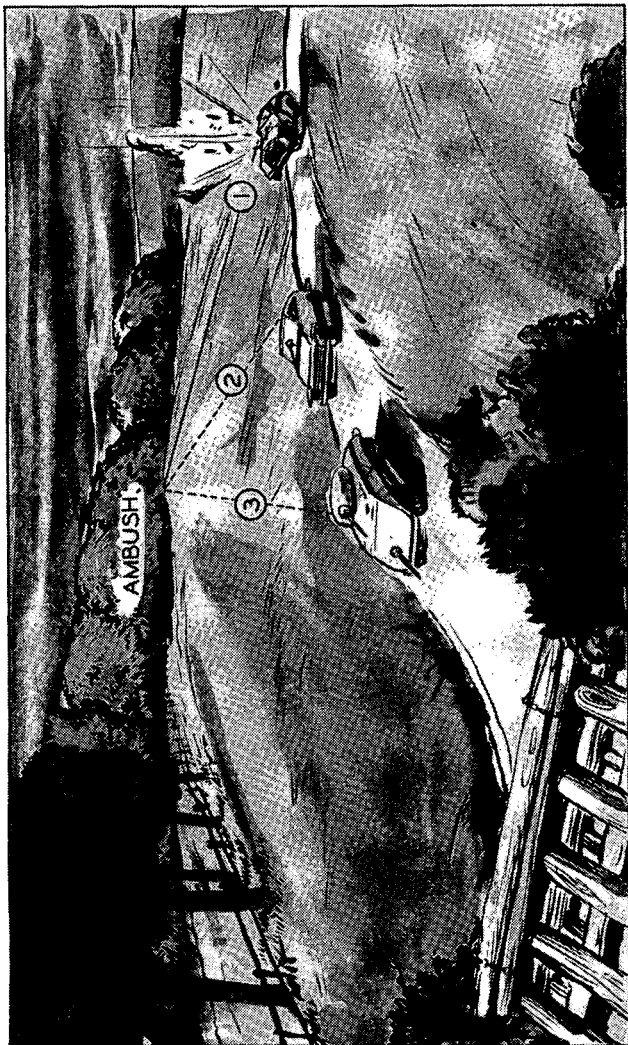

Figure 42. Antimechanized weapons of an ambush should fire on rear vehicles first.

CHAPTER 3

EMPLOYMENT OF CAVALRY

RECONNAISSANCE TROOP, MECHANIZED, CAVALRY RECONNAISSANCE SQUADRON, MECHANIZED

Section I

General

56. MISSION. The reconnaissance troop is the principal reconnaissance element of the cavalry reconnaissance squadron, mechanized. Its primary mission is to furnish the commander of the unit to which the squadron is assigned or attached with information upon which to base a decision for employment of that unit. It has relatively great fire power and mobility and is capable of additional missions of security for the squadron and of combat in the performance of reconnaissance.

57. METHOD OF OPERATION. **a.** The troop operates as does the cavalry reconnaissance troop, mechanized, infantry division, employing infiltration tactics, fire, and maneuver to accomplish reconnaissance missions (par. 17). For tactical operations, an assault-gun platoon from the cavalry assault-gun troop of the squadron habitually is attached.

b. The troop operates on reconnaissance as a unit only in the sense that its commander controls and coordinates the activities of platoons. The platoon is the basic tactical unit, and separate missions are assigned each platoon.

c. The squadron normally operates with two (three) reconnaissance troops initially assigned to active reconnaissance; one reconnaissance troop, together with the light tank company, initially may constitute the squadron reserve. The squadron reserve may be employed to create a gap in the enemy's screen in an area which favors subsequent reconnaissance operations. During the action, reconnaissance elements are prepared to pass through the gap without delay.

d. A reconnaissance troop of the squadron, armored division, with an assault-gun platoon attached, may be attached to a combat command.

e. The troop may be supported by the light tank company, the latter providing combat power to overcome minor opposition. The light tank company may be attached as a unit or by platoons to reconnaissance elements when the squadron front is so broad, or the terrain so difficult, that reserves cannot be moved readily to all parts of the squadron zone. Attachment also may be made when hostile resistance can be foreseen. The light tank company is employed most effectively in combat as a unit, supported by the fire of assault guns to neutralize antitank weapons. (FM 17-30 and 17-32.)

f. The troop may be replaced by tank units for execution of reconnaissance when the volume of enemy fire necessitates greater armor protection for reconnaissance teams and when terrain is too difficult for operation of wheeled vehicles. Light tanks supported by assault guns are effective on reconnaissance

in causing the enemy to disclose the location of antitank weapons.

58. COORDINATION. There must be complete cooperation and coordination of effort between troops of the reconnaissance squadron and between the squadron and other ground and air reconnaissance agencies operating in advance of the division or other higher unit. Direct communication between them by radio, liaison, or other practicable means, must be maintained. Coordination is effected by higher headquarters (par. 18).

Section II

Reconnaissance

59. GENERAL. The reconnaissance troop of the mechanized cavalry reconnaissance squadron executes reconnaissance missions for the same purpose and by the same methods as does the cavalry reconnaissance troop, mechanized, infantry division (pars. 19 to 38, incl.), except that the methods of the former involve employment of attached assault guns.

60. EMPLOYMENT OF ASSAULT GUNS. **a.** The troop employs attached assault guns to support reconnaissance platoons by placing smoke or HE concentrations on organized enemy positions, thereby permitting side-slipping and infiltration by reconnaissance elements. For employment in the conduct of offensive and defensive action, see section IV.

b. The assault-gun platoon, consisting of a platoon headquarters, two assault-gun sections (one assault gun each), and an ammunition section, operates under reconnaissance troop control. Usually, it is held, with one reconnaissance platoon, in troop reserve, and employed as a unit in support of reconnaissance elements as need for such support arises. Such use retains

for the troop commander the initiative in the commitment of his reserve. Exceptionally, individual assault guns (sections) may be attached to and operate separately with reconnaissance platoons. In such cases, the platoon headquarters and ammunition section normally remain with the troop headquarters until engagement of one or both of the guns necessitates resupply of ammunition.

c. In the execution of fire and maneuver, the assault-gun platoon is employed in the base of fire to support the maneuvering element. Assault guns employ direct or indirect fire, depending upon availability of suitable defiladed positions. Primary targets are antitank guns, light and heavy machine guns, and tanks. (FM 17-25 and 17-69.)

d. The decision to open fire and the selection of targets are the prerogatives of the commander of the supported troop or platoon. He may, however, direct the assault-gun platoon or section leader to select and occupy a position, and open fire on favorable targets without further orders.

e. The use of voice radio to direct movement of assault-gun sections is habitual, supplemented where applicable by whistle or arm-and-hand signals.

Section III

Security

61. GENERAL. **a.** The reconnaissance troop of the cavalry reconnaissance squadron, mechanized, is responsible for its own local security and for contributing to the security of the unit to which the squadron is assigned or attached, as is the reconnaissance troop, infantry division (par. 39). In addition, elements of the troop may be called upon to provide security for the troop, or the troop may be designated as an advance, flank, or rear guard, or outpost, for the squadron.

b. Local security measures prescribed for elements of the reconnaissance troop, infantry division (pars. 39 to 47, incl.), likewise apply to the assault guns attached to the reconnaissance troop of the squadron. Elements, when advancing, remove gun covers and set guns for the probable direction of fire. At the halt, air and ground sentinels are kept alert; crews are kept near vehicles. In firing position, the ammunition section is placed where its vehicular armament may be employed to protect the flank and rear of the position from ground attack; it should not be too close to the gun(s). The driver of the ammunition vehicle may be detailed as air and ground sentinel to watch to the flanks and rear. In bivouac areas, assault-gun vehicles should maintain distances prescribed for other vehicles and be placed in positions from which they can go into action without delay.

62. ADVANCE GUARDS. **α.** When acting alone, the troop or platoon employs an advance guard, as do similar elements of the reconnaissance troop, infantry division (par. 41). If an assault-gun section is attached to a reconnaissance platoon acting as advance guard for a troop or larger unit, it takes position in column immediately behind the platoon leader's reconnaissance team, in the center of the advance party.

b. An entire reconnaissance troop may be detailed as the advance guard for a reconnaissance squadron which is the reserve of a group or, for other reasons, is marching as a unit. The attached assault-gun platoon in such cases is placed well forward in the support element.

c. When acting as an advance guard, the troop pushes forward boldly, reconnoiters the route of march, and observes or reconnoiters to the flanks. The advance guard of a reconnaissance platoon operating alone, or the reconnaissance element acting as point of a larger advance guard, normally is held responsible only for visual reconnaissance or the examination of possible enemy positions within effective small-arms range to the flanks. If an advance party is included in the advance

guard, its responsibility for flank reconnaissance extends to a distance of about 800 yards; for a support, about 1 mile.

63. COVERING DETACHMENTS. **α.** Due to the nature of the operations of mechanized reconnaissance units, there are few occasions for the employment of covering detachments for units larger than a platoon. Each platoon provides its own covering detachment, composed of two or three ¼-ton trucks.

b. Exceptionally, the platoon or even the entire troop may form a covering detachment for a larger unit. When a platoon is covering the advance of the troop on a mission such as seizing and holding a key terrain feature, or of the tank company moving to an attack position, all six of its ¼-ton trucks may be necessary to cover the front.

c. When employed as covering detachments, reconnaissance elements are deployed on a broad front with intervals of 150 to 300 yards between vehicles, the determining factors being the maintenance of control by a single individual and the frontage which must be covered. Control of a covering detachment is by the commander of the protected force. If initial contact is expected to be with organized positions, including emplaced antitank or automatic weapons, or with mechanized forces, assault guns may be attached to a covering detachment.

64. FLANK GUARDS. **α.** Reconnaissance elements may be employed as flank guards for the squadron of which they are a part.

b. The strength of a flank guard for a reconnaissance troop moving as a unit will vary from a three-vehicle reconnaissance team to a reconnaissance platoon reinforced with an assault-gun section. A reinforced reconnaissance platoon, or an entire reconnaissance troop with an attached assault-gun platoon, may be employed as flank guard for a squadron.

c. A reconnaissance element employed as a flank guard is interposed between the main body and the located or anticipated hostile threat. The distance of operation to the flank will vary, depending upon the enemy composition, terrain, and

the size of the main force. The disposition of vehicles within a flank guard, the subdivision of the flank guard into elements, and the distances between elements conform to those of an advance guard (par. 41). Movement is based on the progress of the main body or the time limit set by the main body commander for reaching successive phase lines or objectives.

d. A reconnaissance platoon or troop acting as a flank guard is conducted with especial reference to routes or localities which favor attack against the flanks of the main body. It reconnoiters to locate promptly all enemy forces, and takes advantage of its mobility to concentrate in order to defeat or delay the enemy for the necessary period. Contact with the main body is maintained by the use of radio or of vehicular messengers. Sufficient contact must be maintained with advance and rear guards to prevent enemy forces from filtering in between the security elements. A flank guard may be ordered to march parallel to the main body when continuous flank protection is required; when the locality from which an attack may be expected is well defined, the flank guard may be directed to occupy a key position covering the route of approach until the command has passed. In the latter case, dispositions are made upon arrival at the locality to permit holding the position as long as may be necessary. When the enemy is encountered, a flank guard may act offensively, delay in successive positions, or defend a position, as the situation may require.

65. REAR GUARDS. **a.** A reconnaissance troop or platoon may be called upon to furnish a rear guard for the larger reconnaissance unit of which it is a part.

b. The strength and composition of a rear guard provided by mechanized reconnaissance units usually will be identical with those indicated for an advanced guard (par. 62). Formations are similar to those of advance guards reversed.

c. When composed of a reconnaissance platoon, the rear guard is subdivided into a rear party and a rear point. When composed of a troop, a rear support is formed. If reinforced

by assault guns, they will be placed in column in the rear party or rear support in positions corresponding to those prescribed for their disposition in advance guards. Distances between the main body and the rear guard, and between the elements of the rear guard, are governed by the size of the detachment and by the strength, composition, mobility, and proximity of the enemy. The minimum distance is determined by the consideration that the rear guard must delay the enemy until the main body can pass beyond the range of hostile fire or can prepare for action. The maximum distance is that which can be taken without danger of being cut off.

d. A reconnaissance element acting as a rear guard moves, by bounds, based on the progress of the main body. When in contact with the enemy, the rear guard normally operates by delay from successive positions, utilizing long-range fire. Withdrawal from one position to the next is by elements, the movement of the rearmost being covered by the fire of the preceding element; each element avoids masking the fire of the unit covering its withdrawal. The rear party and rear point each reconnoiters and observes to its own rear and flanks and keeps the main body commander informed of the enemy situation.

66. OUTPOSTS. **a.** Reconnaissance platoons or troops provide for their own local security at halts by establishing march or bivouac outposts, as do similar elements of the reconnaissance troop, infantry division (par. 42). The entire reconnaissance troop may be directed to furnish the outpost for the reconnaissance squadron or group of which it is a part.

b. Attached assault guns are employed in the outpost to cover likely avenues of approach for enemy mechanized forces and in the defense of obstacles. Individual guns are placed in hull defilade positions from which they can employ direct fire to repel a hostile attack. Dug-in emplacements will be used in very flat terrain where no concealment or defilade is available. Local security for gun sections is provided as prescribed

in paragraph 61. If positions are to be occupied for any length of time, prone shelters must be dug for the protection of personnel.

Section IV

Combat

67. GENERAL. The reconnaissance troop of the squadron, normally reinforced with assault guns, and with light tanks when their use is anticipated, is prepared to fight for information if necessary to the accomplishment of reconnaissance missions. It also may be used to harass or delay a hostile column, to secure critical routes or areas pending the arrival of other forces, or for counterreconnaissance. Both offensive and defensive action are conducted in accordance with the principles prescribed for similar action by the reconnaissance troop, infantry division (pars. 48 to 55, incl).

68. ATTACHMENTS. **a.** Assault guns are used to supplement other available weapons in the base of fire. Their fire is coordinated with that of mortars, 37-mm guns, and automatic weapons, to avoid duplication of targets. Both HE and smoke ammunition are available. The former is employed to destroy antitank gun and machine-gun crews and tanks, and to pin other enemy personnel to the ground, providing freedom of maneuver for other elements. Smoke is employed to mask the action of maneuvering elements and to prevent observation by enemy gunners.

b. Light tanks are employed in the attack to overrun automatic weapons and personnel, and to penetrate hostile counterreconnaissance screens to permit infiltration of reconnaissance elements. In the defense, they are used to repel enemy attacks and to counterattack.

CHAPTER 4

RIVER CROSSINGS

69. GENERAL. Unfordable streams with varying widths, depths, and currents may be encountered in any theater. To accomplish reconnaissance, the reconnaissance troop must cross them. If bridges or ferries exist, they should be seized and utilized. If they do not, the troop must—

a. Ask for and be prepared to operate $\frac{1}{4}$ -ton and $2\frac{1}{2}$ -ton amphibian trucks.

b. Cross personnel by swimming, by small boats or rafts found or built at the site of the crossing, or by rubber reconnaissance boats.

c. Cross $\frac{1}{4}$ -ton trucks by rafts, by overhead cable, or by wrapping in canvas and floating. (FM's 5-10 and 25-10; TF 7-20.)

d. Cross armored cars and other heavier vehicles by large rafts or by towing submerged. (FM 25-10.)

e. Provide messenger service across the stream by personnel operating small wooden boats, reconnaissance boats, or rafts. Unless rafts capable of transporting the lighter vehicles are provided, it also will be necessary to provide messengers, with vehicles, on both sides of the crossing.

f. Protect the crossing from observation or interference by the enemy.

70. AMPHIBIAN VEHICLES. Amphibian vehicles, due to the increased weight and the susceptibility of their hulls to damage, do not have the cross-country mobility and ability to traverse rough terrain, found in land vehicles of the same cargo capacity. They require firm footing, free of stumps or large stones, to approach and leave the stream; a firm, gradually sloping bank to enter or leave the stream; and a stream bed free of submerged objects or shoals. Because of these conditions, their employment requires specially trained drivers.

71. CROSSING OF PERSONNEL. The first concern of a commander must be to cross personnel with their individual weapons and equipment. Only the stronger swimmers within the unit should cross by swimming. The amount of equipment which they can take depends upon the width of the stream and the strength of the current. Weapons and equipment of two individuals may be made into light rafts by the use of shelter halves. A search should be made for small boats or rafts in the vicinity of the crossing. The rubber boats in the equipment of the troop can be used. If amphibian vehicles are available, and the crossing is unopposed or is defended by personnel already crossed, they may be used to ferry personnel across the stream.

72. CROSSING OF 1/4-TON TRUCKS. If amphibian vehicles are not available 1/4-ton trucks should be the first vehicles to cross. This may be accomplished by raft, by cable, or by floating. Suitable rafts can be constructed from timber found near the site, from driftwood, or from a combination of timber and rubber reconnaissance boats. Two reconnaissance boats provide sufficient buoyancy to carry a 1/4-ton truck (fig. 43). Other means of providing buoyancy include empty 5-gallon cans or sealed wooden or steel barrels. These may be lashed together and reinforced with timbers to provide a platform. To cross vehicles by means of a cable, it is necessary to run the cable from a winch over a support on the near bank, over a support on the far bank, and anchor it securely on the far

bank (fig. 44). Sufficient slack then is given to the cable to permit the attachment of a sling around the vehicle to pulleys on the cable. The cable then is tightened sufficiently by means of the winch to lift the vehicle clear of the ground. By means of ropes fastened to the vehicle, it is pulled across the stream, the cable again slackened by the use of the winch, and the vehicle brought to rest on the far bank. If trees or other strong objects of sufficient height are not available, the necessary support for the cable upon each bank may be provided by an "A" frame. Quarter-ton trucks may be wrapped in canvas of sufficient size and strength and floated across the stream (fig. 45). Canvas paulins, 12 by 17 feet, or large wall tent flies may be used for this purpose. Due to the limited number of these canvas articles within the troop, if several $\frac{1}{4}$ -ton trucks must be crossed by this method, arrangements must be made for the return of the paulin or tent fly to the near bank after each vehicle is crossed.

73. CROSSING OF ARMORED CARS. Armored cars and the other heavier vehicles cannot be floated by the means organic within the troop. If suitable materials can be found in the vicinity of the crossing, rafts of sufficient strength may be constructed. In case of emergency, these vehicles may be waterproofed and towed submerged through the stream. (FM 25-10; TF 6-105.) This is a time-consuming operation and, in the usual case, it will be found quicker to await the bridging of the stream or the arrival of equipment suitable for providing rafts for their transport.

74. COMMUNICATIONS. Early provision for messenger service to and from subordinate units on the far bank of the stream is provided. While radio communication is available early through the crossing of the $\frac{1}{4}$ -ton trucks carrying such facilities, there still remains the necessity for providing means of transmitting messages, maps, reports, and documents which cannot be handled by radio. This messenger service initially is provided by rubber reconnaissance boats or other small boats.

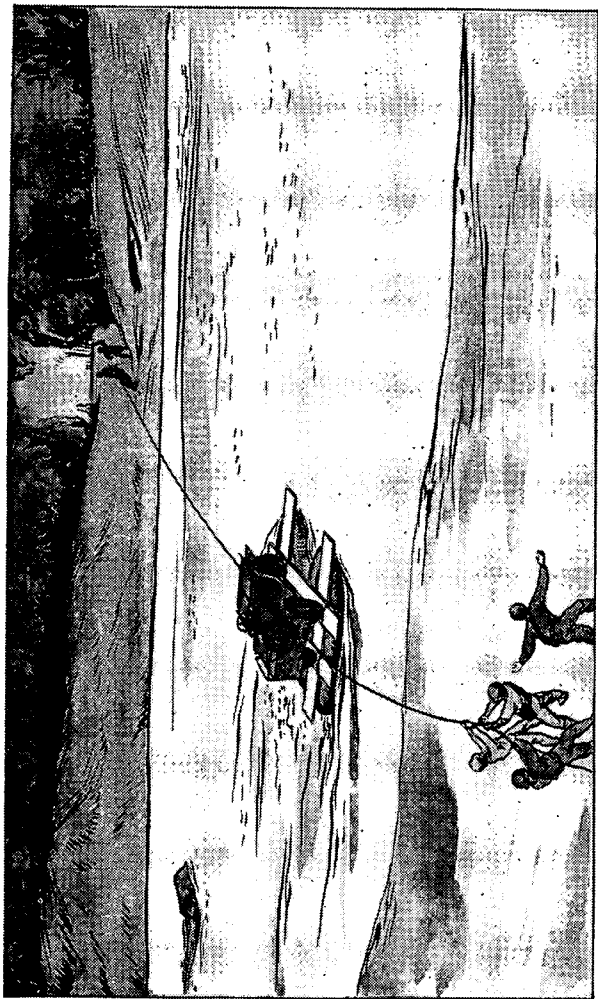

Figure 43. Rubber reconnaissance boats may be rafted together with planking to transport $\frac{1}{4}$ -ton trucks across streams where banks are not too steep, where there is little floating debris, no shoals, and floating depth of water next to shore lines.



Figure 44. Truck suspended from cable. Note use of snatch block and tow chains. After the blocks are placed over cable, the winch only takes up slack sufficiently to lift vehicle off the ground; the more slack left, the better. It avoids excessive strain on the cable.



Figure 45. 1/4-ton trucks wrapped in paulins may be floated across a stream.

If facilities for promptly crossing $\frac{1}{4}$ -ton trucks are not available, a relay of messengers provided with these vehicles, both to and beyond the river bank, is set up.

75. SECURITY. A crossing site initially free from enemy observation and interference is selected. It may be expected that the crossing will be discovered early. The first and succeeding elements which cross furnish protection for the remainder of the troop during its crossing. It may be advisable to cross the first elements at one site and the remainder at another site. In such case, part or all of the leading elements may be directed to the other site, in order to provide security on the far bank of the stream. The troop is not organized or equipped to cross expeditiously and continue a reconnaissance mission in the face of enemy opposition. If this is ordered, the troop must be suitably reinforced with engineer troops and matériel.

76. COMBAT. The basic principles of combat operations at river lines are covered in FM 100-5.

CHAPTER 5

SIGNAL COMMUNICATION

Section I

General

77. MISSION. The primary mission of signal communication personnel in the cavalry reconnaissance troop, mechanized, is to provide rapid, secure, and uninterrupted communication from reconnaissance elements to higher headquarters. They operate and maintain signal communication within the unit, with attached units, and with adjacent units when required.

78. RESPONSIBILITY FOR SIGNAL COMMUNICATION. **a.** The troop commander is responsible for signal communication within the troop and with higher headquarters.

b. The troop liaison and communications officer conducts the technical training of communication personnel and supervises maintenance of signal communication equipment.

c. During operations, the troop executive officer supervises operation and maintenance of the signal communication system.

79. MEANS OF SIGNAL COMMUNICATION. The means of signal communication organic in the troop are discussed in section II. Radiotelegraph, radiotelephone, and messengers are the principal means.

80. COORDINATION OF SIGNAL COMMUNICATION.

a. Effective signal communication requires coordination in all echelons. Paragraph 5 of the field order of the unit to which the troop is assigned or attached prescribes a coordinated plan and designates current signal operation instructions (SOI) and other pertinent references. SOI contain radio call signs, operating frequencies, code references, cipher keys, authenticator systems, schedules for radio and messenger service, pyrotechnic and panel codes, and other current technical information.

b. Coordination within the troop is obtained by using standing operating procedure (SOP). This may consist of brevity codes, special sound and visual signaling instructions, a maintenance system, personnel assignments and reliefs, and solutions to other problems. Signal communication personnel should be drilled so that it will be unnecessary to carry written copies of SOP into combat.

81. SIGNAL COMMUNICATION PERSONNEL. Effective signal communication requires highly trained personnel. Carelessness, inaccuracy, or failure to maintain equipment may result in disaster. Careful selection of individuals for training as signal communication specialists is most important. Selected individuals should have completed individual training with above average records.

82. SIGNAL COMMUNICATION TRAINING. **a. General.** All members of the troop should receive basic signal communication training (TM II-450). Subjects of greatest importance are message writing, message center procedure, the use of codes and ciphers, and radiotelephone procedure.

b. Specialist training. Section III covers training of communication specialists.

83. SIGNAL COMMUNICATION SECURITY. Carelessness or ignorance of necessary precautions in the employment of signal communication means may disclose vital information to the enemy or compromise the security of the troop. All personnel must be trained to preserve signal communication security. Commanders should monitor the nets of subordinate units to detect violations of security regulations (par. 89).

Section II

Means of Signal Communication

84. GENERAL. **a.** Signal communication within the troop is effected by radio, messengers, visual means, and sound. Signal communication between the reconnaissance troop and other headquarters is accomplished by radio or other appropriate means.

b. An agency to coordinate the use of the various means of signal communication is required in troop headquarters. Records of all messages are maintained in troop and platoon headquarters. Selected individuals must be trained as message center specialists in addition to their training in assigned specialties.

85. UTILIZATION OF ASSIGNED MEANS OF SIGNAL COMMUNICATION. **a. Radio.** Radio is the principal means of signal communication in the reconnaissance troop. The proper utilization of radio equipment is a major responsibility of the troop commander. He should know the capabilities and limitations of each type of equipment, including the transmission characteristics of CW, tone, and voice in the bands of frequencies available. He should understand the application of ionospheric data to the operation of his assigned radio equipment. (TM 11-499.)

b. Messengers. (1) Vehicular and dismounted messengers are used to deliver maps, overlays, sketches, detailed orders, and lengthy reports. Messengers are faster than radio communication under some conditions.

(2) Dismounted messengers are used when distances are short, and when movement in vehicles is impracticable.

(3) Motor messengers may use organic, captured, or impressed vehicles. Command and communication vehicles should not be used for transporting messengers except in an emergency.

(4) Officers may carry important messages, particularly when an explanation of the situation is required.

c. Arm and hand signals. See FM 2-7 (when published) and FM 22-5.

d. Pyrotechnics. Pyrotechnics are illuminated signals which are discharged into the air.

(1) **ADVANTAGES.** (a) Transmission of the message is prompt.

(b) The equipment is comparatively light and compact.

(2) **DISADVANTAGES.** (a) Messages of fixed meanings only can be transmitted.

(b) Pyrotechnic signals may be misunderstood.

(c) Messages may not be observed unless discharged from a predetermined locality at a prearranged time.

(d) Range of observation is limited, especially in the daytime.

(e) Pyrotechnics have little signal security unless codes are changed frequently.

(f) Errors in transmission cannot be corrected readily.

(3) Pyrotechnic codes are published in signal operation instructions. Special signals must not conflict with prescribed codes.

e. Smoke. Colored smoke is used to identify friendly troops in daylight. It may be used also to transmit short messages in accordance with a prearranged code.

f. Flags. Flags are used to identify vehicles, to send messages in semaphore or wigwag code, or to transmit prearranged messages.

g. Panels. Fluorescent panels are used to identify friendly troops to supporting air forces. Signaling panels are used to identify ground units to air forces and to transmit brief messages in the current panel code.

h. Sound signals. See FM 2-7 (when published) for whistle and bugle signals. They are used for close-in communication by small units.

86. WIRE COMMUNICATION. Wire is not an organic means of signal communication. It is desirable that signal communication specialists have sufficient knowledge of the use of wire communication to use and repair field wire circuits, to read military line route maps and circuit diagrams, and to use or interrupt commercial wire circuits. This instruction should be initiated after specialists have become proficient in the use of organic equipment.

Section III

Training

87. GENERAL. a. Training objective. The objective is to train all members of the troop in the use of organic signal equipment.

b. Personnel to be trained. (1) All personnel must be able to use the Division Field Code, the Converter M-209, pyrotechnic codes, panel codes, combat codes, brevity codes, and map coordinate codes.

(2) All personnel must be trained in the use of radiotelephone procedure.

(3) All personnel should be trained in the duties of messengers.

(4) All personnel should be trained in writing clear, concise, and correct messages.

(5) At least three individuals of troop headquarters should be trained as message center specialists.

(6) At least one radio operator per station which operates in nets of higher units should be capable of transmitting messages in International Morse Code at speeds up to 30 words per minute, with a minimum of 15 words per minute under normal conditions.

(7) All radio operators and radio repairmen must be trained in operator's (first echelon) and unit mechanic's (second echelon) radio maintenance. (Signal Corps Circular 11-1.) These men should receive training in wire communication when time permits (par. 86).

c. Training, how conducted. Training will be conducted in accordance with War Department training publications. (FM 21-6.)

d. Schools. Instruction of specialists should be centralized. The troop commander organizes instruction, within the troop, unless schools of a higher echelon are available. He verifies the proficiency of specialists regardless of where they are trained. For proficiency standards, progress reports, and tests, see TM 11-450 and AR 615-26.

88. COMMON SUBJECTS. All members of the troop should be trained in subjects contained in the following publications:

TM 11-460, Division Field Code.

TM 11-461, Air-Ground Liaison Code.

TM 11-380, Converter M-209.

FM 24-9, Combined United States-British Radiotelephone (R/T) Procedure.

FM 21-45, Protective Measures, Individuals and Small Units.

CCBP 8, Combined Panel System (Combined Communications Board Publication).

For training of message center specialists and of specialists in wire communication, see FM 24-5.

89. SIGNAL SECURITY. α. General. Common violations of signal security are:

- (1) Discussion of plans for troop dispositions by radiotelephone.
- (2) Transmission of tactical radio messages in clear text.
- (3) Transmission of lengthy radio messages. Long messages enable enemy to copy traffic and locate the sending station.
- (4) Failure to employ brevity codes or map coordinate codes.
- (5) Reference in the clear to information transmitted previously in code.
- (6) Failure to destroy SOI, maps, messages, orders, and other papers when in danger of capture.
- (7) Transmission of messages in the clear which refer to organizations, individuals, or equipment.
- (8) Any variation in volume of radio traffic which might disclose reinforcement or impending action.

b. Training of signal communication personnel.

Signal security is discussed in the following publications:

FM 11-35, Signal Corps Intelligence.

FM 24-18, Radio Communication.

FM 24-5, Signal Communication.

TM 11-454, The Radio Operator.

Combat Code No. 1, Use of Combat Codes.

90. RADIO OPERATORS. α. For training of radio operators, use of code practice equipment, radio procedure, and other operational information, refer to—

TM 11-459, Instructions for Learning International Morse Characters.

TM 11-432, Code Practice Equipment.

TM 11-454, The Radio Operator.

TM 11-499, Radio Propagation Handbook.

FM 24-6, Radio Operators Manual, Army Ground Forces.

FM 24-11, Combined Operating Signals.

FM 24-10, Combined Radiotelegraph (W/T) Procedure.

FM 24-9, Combined United States-British Radiotelephone (R/T) Procedure.

FM 24-18, Radio Communication.

FM 24-5, Signal Communication.

b. Radio operators should receive training in maintenance of equipment concurrently with other instruction (par. 91).

91. MAINTENANCE. a. General. Signal communication personnel must be skilled in maintenance to insure proper functioning of radio equipment. A system which includes preventive maintenance must be established, tested, and applied habitually within the troop. Careful training and diligent supervision are necessary.

b. Responsibility. The Signal Corps performs maintenance which the operator and unit mechanic are not equipped to perform.

c. Testing radio equipment. Tests which can be applied by unit mechanics with available equipment are:

(1) Visual checking. The set is examined for broken elements or burned insulation.

(2) Point-to-point measurements. Voltages and resistances are measured by meters at specified points within circuits and compared with correct readings.

d. Repairs. A list of repairs which may be performed by operators and mechanics should be prescribed within each troop. The repairs which unit personnel may perform are determined by—

(1) Skill of operators and mechanics.

(2) Instruments, tools, and spare parts available.

e. Progressive training. Texts, arranged in order of simplicity, to be used as a guide for maintenance training, include—

TM 1-455, Electrical Fundamentals.

TM 11-455, Radio Fundamentals.

TM 11-453, Shop Work.

TM 11-300, Frequency Meter Sets SCR-211-A, SCR-211-B, and SCR-211-C.

TM 11-321, Test Set I-56-E.

TM 11-702, Interphone Equipment RC-99.

TM 11-273, Radio Sets SCR-193-A, B, C, D, and E.

TM 11-630, Radio Set SCR-506-A.

TM 11-615, Radio Sets SCR 609-() and 610-().

TM 11-600, Radio Sets SCR-508-(*), SCR-528-(*), and SCR-538-(*).

92. WIRE COMMUNICATION. Troop signal communication specialists are trained to operate wire communications, TM 11-450 includes an outline of course in basic signal communication and prescribes the qualifications of field lineman. These may be used as guides in training.

93. STANDING OPERATING PROCEDURE. α. General.

Standing operating procedure should be developed concurrently with training. It should embrace eventually all features of signal communication which can be standardized without loss of effectiveness.

b. Suggestions for SOP. (1) Prescribe various radio net organizations. They must conform to channels allocated by higher headquarters. Two types of radio nets are shown in figures 46 and 47.

(2) Indicate when messenger communication will be used.

(3) Designate elements charged with operating visual communication.

(4) Prescribe relief operators for radio stations, which may be required to operate continuously.

(5) Prescribe short codes to reduce radio transmissions. These should be coordinated with higher headquarters.

(6) Prescribe the sequence in which radio frequencies are to be used in avoiding enemy interference. Each armored car contains two radio sets, one of which is so designed that two of twenty channels may be guarded continuously. Transmissions are available instantly on any one of ten channels. The

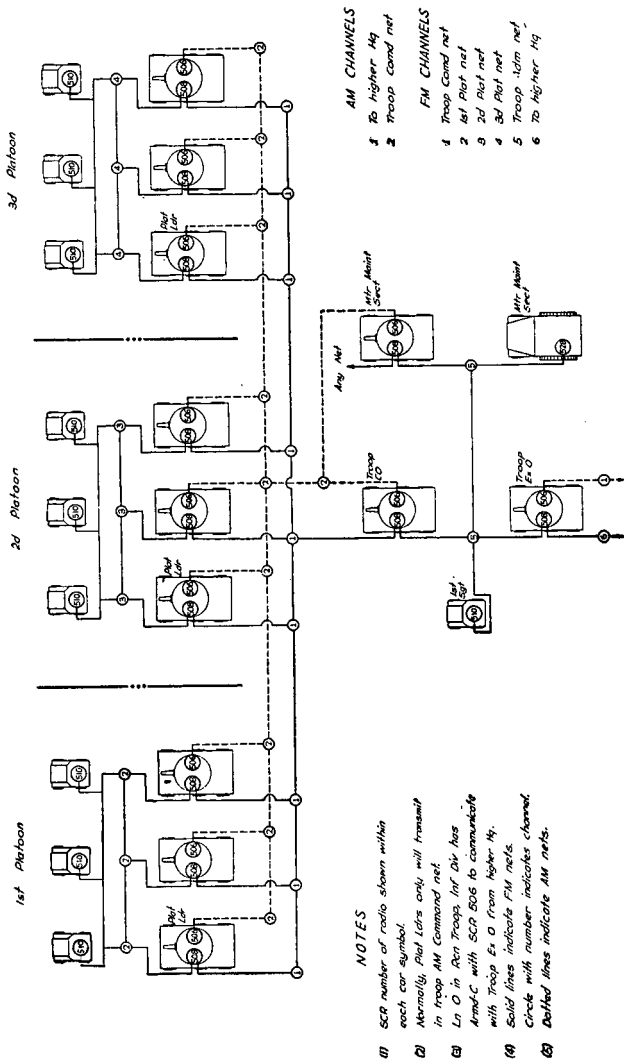

- NOTES**
- (1) SCR number of radio shown within each car symbol.
 - (2) Normally, Plat Ltrs only will transmit in Troop AM Command net.
 - (3) Lt O in Recon Troops Inf Div has Arm'd-C with SCR 806 to communicate with Troop Ex O from Higher Hq.
 - (4) Solid lines indicate FM nets.
 - (5) Circle with number indicates channel.
 - (6) Dashed lines indicate AM nets.

Figure 46. Radio nets, cavalry reconnaissance troop, mechanized.

other set can guard only one channel at a time, but can transmit instantly on any one of five preset channels. The versatility of this equipment permits great variation of the sequence in which channels can be used. The plan should be coordinated with higher headquarters.

(7) List permissible repairs to various types of equipment, and prescribe method of carrying spare parts and spare operating equipment.

Section IV

Miscellaneous

94. AIR-GROUND COMMUNICATION. The principal means of air-ground communication is the very high frequency radiotelephone used by air support parties and air liaison parties attached to ground units for that purpose. Signaling panels, pyrotechnics, lights, smoke, prearranged signals, and drop and pick-up messages are supplementary means of air-ground communication. Only slow-speed planes are used to pick up messages.

95. ENEMY INTERFERENCE. Enemy interference with radio communication is discussed in FM 24-18 and TM 11-454.

96. DESTRUCTION OF EQUIPMENT. Methods of destroying signal equipment are prescribed in FM 24-18 and in Technical Manuals for the various types of radio sets.

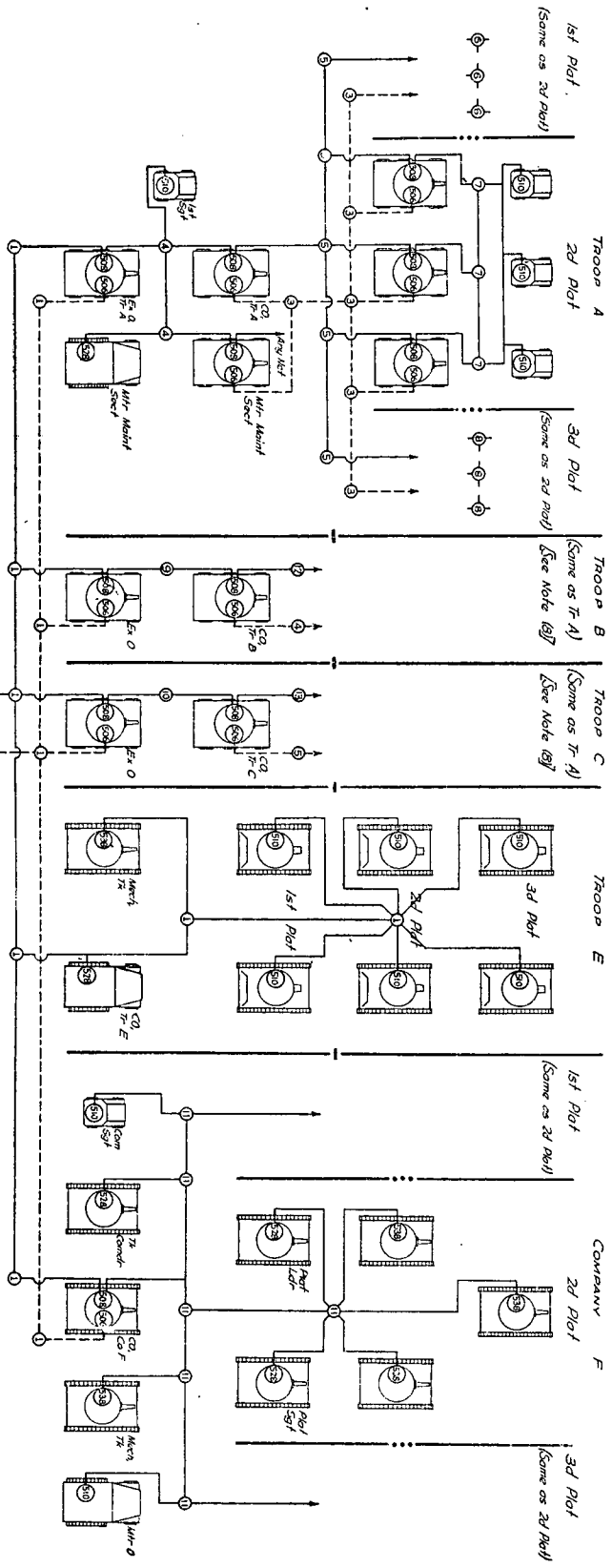

NOTES

- (1) Reserved for CO.
- (2) Reserved to monitor nets or set up a special net if the situation demands it.
- (3) To be used by Liaison Officers. Whena beaked of higher Hq the SCR 506 will net with SCR 506 in Ex O car.
- (4) When Pltof of Assault Gun troop are attached to other units the Pltof radio will work in the respective unit net.
- (5) Dotted lines indicate AM nets.
- (6) Solid lines indicate FM nets. Circles with numbers indicate channel SCR 538 receiver only.
- (7) When Troop D is present in Sg the nets will be the same as Troop A.
- (8) All Plon Pltof FM channels are the same as Troop A.

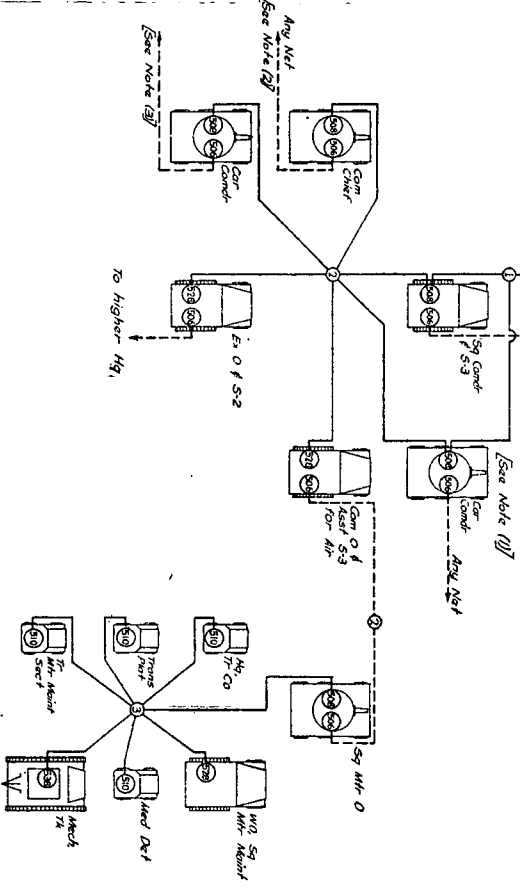

FM CHANNELS

- 1 Sg Comd net
 - 2 Sg Adm net
 - 3 Sg rear echelon net
 - 4 Troop A Adm net
 - 5 Troop A Comd net
 - 6 1st Pltof net
 - 7 2d Pltof net
 - 8 3d Pltof net
 - 9 Troop B Adm net
 - 10 Troop C Adm net
 - 11 Company F Comd net
 - 12 Troop B Comd net
 - 13 Troop C Comd net
- AM CHANNELS**
- 1 Sg Comd net
 - 2 Sg Adm net
 - 3 Troop A Comd net
 - 4 Troop B Comd net
 - 5 Troop C Comd net

Figure 47. Radio nets, cavalry reconnaissance squadron, mechanized.

CHAPTER 6

LOGISTICS

Section I

Supply

97. REFERENCES. For the reconnaissance troop organic in the cavalry reconnaissance squadron, mechanized, see FM 2-30. For the reconnaissance troop organic in the infantry division, see FM 100-10. For reconnaissance troops of the cavalry reconnaissance squadron of the armored division, see FM 2-30, 17-50, and 100-10. While the S-4 of the armored combat command will assist in facilitating supply for reconnaissance troops attached to the command, the channel to accomplish it may be through the reconnaissance squadron or direct from division, depending upon its location with respect to the former, so that either FM 2-30 or FM 17-50 may apply. In the exceptional case, the troop may be attached for supply to a battalion of the armored combat command. In this instance, see FM 17-50.

98. RESPONSIBILITY FOR SUPPLY. Since supply is a function of command which cannot be delegated, the troop commander is responsible for the supply of his organization. This responsibility includes the anticipation of supply needs, the timely submission of requests and data upon which amounts of supply are based, and the distribution of supplies made available. This responsibility embraces not only the supply of the troop, but also of attached units.

99. MEANS. For the means available to the troop, see current Tables of Organization and Equipment. Personnel and equipment are grouped in an administrative, supply, and mess section. The transportation within this section must be pooled for all classes of supply, to insure its most economical use in drawing from supply points and in distributing to platoons and sections. This section must maintain close liaison with the maintenance section in order to know at all times the needs for replacement of weapons, combat vehicles, and radios, together with the status of the spare parts and tools for maintenance of these items.

100. CLASS I SUPPLY. **a.** This class of supply includes those items which are consumed at a relatively uniform daily rate, such as rations, water, and kitchen fuel. A ration is the allowance of food for one person for 1 day. In time of war or national emergency, the field ration is used. It is issued in kind and may be any one of several types. The amount of each type to be carried in troop transportation will be fixed by the division, corps, or army commander. At least 10 day's supply of emergency rations should be carried in each vehicle at all times.

b. Troops should receive three meals a day. If the tactical situation permits, at least two of these meals are hot. However, due to the dispersion of the platoons in active operations, a major portion of troop personnel frequently must subsist on type C, D, or K rations. To heat these will require individual or crew effort. Whenever practicable, the B ration should be

served. Hot meals can be prepared in the troop kitchen, transported to detached elements, and reheated on the one-burner gasoline cooking outfit provided for each vehicle; or the components of the ration may be sent to the detached elements and cooked. The unconsumed portion of a B ration can be issued to individuals for lunches.

c. Rations are replaced daily. The basis of replacement is the strength of the troop to be fed, as estimated 1, 2, or 3 days in advance. The troop commander is responsible that this estimate is forwarded daily to the headquarters of the next superior unit. To draw the rations, a vehicle of the administrative, supply, and mess section reports to the squadron train bivouac and, in company with similar vehicles of other troops, proceeds to a ration supply point. The vehicle of the reconnaissance troop of an infantry division may go alone to the supply point. Since reconnaissance troops ordinarily will be operating well to the front, the trip to the supply point serving the bulk of the division or corps troops will be unduly long. The troop commander should not hesitate to request that an advance supply point be established to supply his organization in the forward area.

d. Water may be issued with the rations, but in most cases the troop will procure it locally from an advance water point operated by the division or corps engineers. The troop commander is responsible that the water is sterilized or boiled, except that water from approved sources need only be tested by the orthotolodine test. It is supplied to personnel from canvas water sterilizing bags in the vicinity of the kitchen, or is sent to platoons in 5-gallon water containers. When these methods of supply prove inadequate, each platoon may prepare a canteen full of sterilizing solution and with it, immediately after preparation, sterilize the contents of all canteens in the platoon. A canteen cap full of the solution is sufficient for each canteen of water. The water should not be used until 30 minutes after being treated with the solution.

101. CLASS II SUPPLY. **a.** This class of supply comprises articles for which allowances are affixed by Tables of Equipment. Typical items are individual clothing and equipment, arms, vehicles, tools, and radios. Prior to movement into a combat zone, the troop commander must insure that amounts authorized are on hand. Thereafter, he should see that clothing and equipment not essential to fighting are replaced during periods when the troop is not engaged in combat. Other items should be replaced as soon as they are lost, damaged beyond organizational repair, or destroyed.

b. To accomplish initial issue or replacement, the troop commander submits a requisition to the next higher commander. The troop commander is responsible that sufficient transportation is dispatched to haul the supplies. He also is responsible for providing drivers to bring replacement vehicles from the supply point.

102. CLASS III SUPPLY. **a.** This class of supply includes gasoline and lubricants necessary for the operation of the vehicles of the troop. The amount of gasoline needed to move all the vehicles of the troop 1 mile is called the "unit mile." This amount is used for the computation of quantities necessary for marches. The amounts of grease and oil needed are computed by multiplying the unit mile by factors determined by the troop motor officer from experience in similar operations, or as prescribed by a higher commander. For a movement, all tanks and all containers carried on vehicles are filled before starting. Additional supplies of this type may be carried on the maintenance vehicles or may be furnished en route by the squadron or division. Supplies necessary to refill all tanks and containers at the end of the march will be hauled from Class III supply points by vehicles of the troop.

b. During combat, the needs for this class of supply will be highly variable. This makes it essential that the troop and subordinate commanders maintain the full supply by requiring refilling of tanks and containers at every opportunity. The squadron or division will establish supply points to which

troop supply vehicles will haul empty containers. The vehicle and all containers will be filled and other items issued drawn in new containers. Gasoline and lubricants may be distributed to platoons by the vehicles used by messengers, or by those taking rations forward. In the latter case, precautions to avoid contamination of food by gasoline must be taken. A supply of gasoline and oil should be available in the vicinity of the troop command post at all times. It should be SOP that the driver of any vehicle will refill upon each visit thereto.

103. CLASS IV SUPPLY. **α.** This class includes those articles which are not covered in Tables of Equipment and demands for which are related directly to operations contemplated or in progress (except for articles in Classes III and V). For the reconnaissance troop, this class will include amphibious $\frac{1}{4}$ -ton and $2\frac{1}{2}$ -ton trucks and additional pioneering and communication equipment. Issue may be accomplished prior to or during combat. The authorized amounts should be maintained by replacement during combat.

b. The troop commander submits a requisition for the quantities authorized or needed. The requisition will be processed and the items drawn and distributed as described for Class II supplies. If the issue has not been authorized previously, the troop commander should include with his requisition a statement of the situation or conditions which cause the need for the articles.

104. CLASS V SUPPLIES. **α.** This class of supplies includes ammunition, pyrotechnics, antitank and antipersonnel mines, grenades, and chemicals. During combat, the troop commander must make every effort to insure that all combat vehicles are fully supplied at all times. This may require practically continuous operation of the bulk of his supply vehicles.

b. For the resupply of ammunition for a troop of a squadron, the supply sergeant or an ammunition agent will—

(1) Obtain from the troop commander a written request for the ammunition needed.

(2) Obtain the vehicle or vehicles necessary to transport the ammunition.

(3) Proceed to the rear echelon of squadron headquarters and have the request approved by the squadron S-4.

(4) Be directed by S-4 either to proceed immediately to the corps troops ammunition office or, if part of an armored division, to the division ammunition office; or to wait for a squadron train to go to that point.

(5) Have the ammunition request countersigned by the division or corps troops ammunition officer or his representative.

(6) Proceed to the ammunition supply point, obtain the ammunition, surrender the countersigned ammunition request, and return to his troop area.

(7) Send the ammunition forward to the platoons by one of the ammunition-carrying vehicles or, if the amount needed for a complete refill is small, by a messenger vehicle.

c. For ammunition resupply of the reconnaissance troop of an infantry division, the procedure is the same as given in **b** above, except that the supply sergeant or ammunition agent proceeds directly from the troop area to the division ammunition office.

d. For the reconnaissance troop detached from a squadron to operate with an armored combat command, the procedure may be the same as given in **b** above, or the request may be approved by the combat command S-4 instead of the squadron S-4.

105. LOCAL PROCUREMENT OF SUPPLIES. **a.** When engagement at a considerable distance from supply points can be foreseen, plans for the utilization of local resources should be made and authorization therefor obtained. The extent of such local resources will be variable in different theaters and areas within theaters. The only supplies which will be found in most localities will be rations and water. Occasionally, fuel and lubricants may be obtained. Any such local procurement will be of great assistance, since it will release more vehicles for the transportation of other supplies.

b. For methods of local procurement, see FM 10-5 and pertinent instructions issued by the theater commander.

106. USE OF CAPTURED SUPPLIES. α. The reconnaissance troop may, at times, capture enemy supplies and matériel. If needed, they are utilized. Prior to use, captured matériel should be examined carefully for booby traps and missing safety features. Food, motor fuel, and lubricants should be checked for contamination. The latter should be used only in enemy vehicles except in emergency.

b. In order that captured weapons and vehicles may be placed in action expeditiously, all members of the troop should be trained in their operation before entering combat.

Section II

Vehicular Maintenance and Evacuation

107. REFERENCES. For all reconnaissance troops: AR 850-15; FM 25-10 and 100-10; TM 9-2810, 10-460, and 21-300, and TM 21-301 (when published).

108. RESPONSIBILITY FOR MAINTENANCE. α. Proper maintenance is a command function of all echelons which must receive continuous personal attention of all commanders. The responsibility for proper maintenance cannot be delegated by the troop commander.

b. Repairs to motor vehicles will be performed in the lowest echelon of maintenance consistent with the availability of suitable tools and spare parts, capabilities of mechanics, time available, and the tactical situation. Subject to these limitations, troop maintenance personnel will make every effort to keep needed vehicles in service without regard for the echelon of repairs made. Repairs may include, when necessary, "can-

nibalizing" or combining of usable parts and assemblies of disabled vehicles to create usable vehicles. Vehicles which are damaged beyond repair facilities of the troop are evacuated to higher echelons of maintenance.

109. FIRST ECHELON MAINTENANCE. **a.** The vehicle driver (or crew) is the most important single factor in preventive maintenance. Only through him can the mechanic know what trouble a piece of equipment is giving.

b. Each driver is expected to perform certain daily maintenance services as a matter of regular routine; this is called first echelon maintenance.

c. Preventive first echelon maintenance by the driver includes—

(1) Inspection and servicing the vehicle in accordance with those operations listed on War Department Form No. 48 (see TM 9-2810).

(2) Repair of defects which the driver is capable of repairing, equipped to repair, and authorized to repair.

(3) Report of defects the repair of which is not a function of the driver.

(4) Prevention of vehicle abuse.

110. SECOND ECHELON MAINTENANCE. **a.** Second echelon maintenance is performed by the troop maintenance section. The duties of this echelon include preventive maintenance, adjustments, minor repairs, and minor unit replacement within the limits of its personnel, tools and equipment, parts, time, and the tactical situation.

(1) Personnel authorized are shown in current Tables of Organization.

(2) Tools and equipment are authorized by current Tables of Equipment.

(3) Parts are authorized in Ordnance Standard Nomenclature Lists.

b. For the reconnaissance troop of the cavalry squadron, mechanized, further second echelon maintenance is provided in

the squadron maintenance platoon, which has more equipment, personnel, and tools, and more time to work on vehicles.

111. TROOP MAINTENANCE PROCEDURE. When a vehicle in a platoon becomes disabled, the driver checks the vehicle. If it cannot be repaired by the driver, the platoon leader notifies the troop commander of the location of the vehicle and the nature of the damage, when practicable. The troop commander notifies the motor officer who dispatches the maintenance section, or part of it, which usually is in the vicinity of the troop command post, to the location of the vehicle. The maintenance section performs the repairs necessary on the vehicle, evacuates it to the troop service area for further repairs, places the vehicle on the axis of communication, or leaves it in place and notifies the next higher echelon maintenance unit as to its location.

Section III

Medical Service for the Troop

112. MEDICAL PERSONNEL. **a.** The reconnaissance troop has no organic medical personnel. Two medical aid men from the squadron medical detachment should be assigned to each actively operating troop of the cavalry reconnaissance squadron, mechanized.

b. For the reconnaissance troop of the infantry division, medical aid men may be obtained from the medical battalion, in some situations.

c. Due to the limited number of medical aid men available to mechanized cavalry troops, the troop commander should insure that all men are trained in administering first aid.

d. Responsibilities of medical aid men include—

(1) Administering first aid.

(2) Filling in and attaching to casualties emergency medical tags.

(3) Accompanying serious casualties being evacuated.

113. DISPOSITION OF CASUALTIES. a. After minor casualties have been treated, they continue with their units. Serious casualties, after initial treatment, should be evacuated as soon as the tactical situation permits.

b. Methods of evacuation of casualties will vary. When feasible, arrangements are made with medical units to evacuate by ambulance. In many situations, and especially in the case of the reconnaissance troops of infantry divisions, troops and platoons will operate in areas through which other friendly troops will not necessarily pass. In such situations, troops and platoons must evacuate their casualties in administrative or tactical transportation to the nearest aid station as soon as the tactical situation permits. In the case of the reconnaissance troop of the cavalry reconnaissance squadron, mechanized, the squadron aid station usually will be located in the vicinity of the squadron command post. Ambulances may be attached to troops on reconnaissance. In the case of the reconnaissance troop of an infantry division, casualties should be evacuated to the nearest medical installation. In moving situations, when it is known that friendly forces will cover the same ground, casualties may be left on the axis of movement of the higher units.

Section IV

Prisoners of War

114. GENERAL. **a.** Prisoners should be disarmed immediately after capture. Normally they will be permitted to retain their clothing, identification tags, decorations, insignia of rank, and valuables. Officers, noncommissioned officers, and enlisted men must be divided into separate groups.

b. Documents found on prisoners will be removed from them, identified with the prisoner on whom found, and sent to the rear with the prisoner from whom taken.

c. New identifications must be reported immediately to the unit S-2, giving time and place of capture.

d. In order to obtain maximum information from prisoners, they must be interrogated before the shock of capture or injury wears off. Therefore, it is important that prisoners reach higher echelon interrogation sections as soon as possible. For this reason, maximum use must be made of returning motor transportation and captured motor vehicles for the evacuation of prisoners.

e. Wounded prisoners are evacuated in the same manner as friendly wounded.

f. When large numbers of prisoners are taken, or when the situation makes evacuation by the troop impractical, prisoners should be segregated and left under guard. Their identity and location should be reported. When no guard is available, prisoners should be immobilized. (FM 100-10.)

Section V

Burials

115. GENERAL. Burial normally is by Army, but in emergencies may be by organization. The organization responsible for burials will be specified in the administrative order of higher headquarters or designated in separate instructions. If burial is by organization, reports will be made through channels as to location of graves and such data as may be required for grave registration. Information to be recorded includes decedent's name, serial number, grade, and organization; place, cause, and date of death; date of burial, and location of grave. (FM 100-10; TM 10-630.)

INDEX

	Paragraph	Page
Action:		
Breaking off.....	55	82
Defensive.....	54	81
Delaying.....	54	81
During air attack.....	44	70
Offensive.....	48	72
Advance:		
By bounds.....	27	22
Control.....	23	20
Guards.....	41, 62	38, 90
Rate.....	20	18
Air attack, action during.....	44	70
Air-ground communication.....	94	112
Ambush.....	54	81
Amphibian vehicles, use.....	70	96
Antiaircraft security measures.....	44	70
Antimechanized security measures.....	45	71
Areas, routes, and zones.....	21	19
Arm-and-hand signals.....	85	104
Assault guns, employment.....	60, 68	88, 94
Attachments for combat.....	68	94
Base of fire.....	50	73
Bivouac:		
Hostile, reconnaissance.....	37	36
Outposts.....	66, 42	93, 38
Security.....	42	38
Bounds, advance by.....	27	22
Breaking off action.....	55	82
Bridge or defile, reconnaissance.....	36	33
Burials.....	115	124
Captured supplies, use.....	106	119
Casualties, disposition.....	113	122
Ceremonies.....	15	16
Characteristics of—		
Vehicles.....	5	4
Weapons.....	6	5
Chemicals, security against.....	46	72

	Paragraph	Page
Classes of supply	100-104	114
Column, hostile, reconnaissance of	38	36
Combat:		
At river lines	76	101
Attachments in	68	94
Coordination and control	52	78
Defensive	54	81
Employment of weapons	51	74
Missions	67	94
Objectives	49	73
Offensive	48	72
Tactical groupings in	50	73
Communication:		
Air-ground	94	112
At river crossings	74	97
Coordination	80	103
Enemy interference with	95	112
Equipment, destruction	96	112
Maintenance	91	109
Means	79, 84	103, 104
Mission	77	102
Personnel	81	103
Responsibility	78	102
Security	89	108
Standing operating procedure	93	110
Training	82, 87	103, 106
Utilization of assigned means	85	104
Wire	92	110
Communication equipment:		
Destruction	96	112
Maintenance	91	109
Concealment from air attack	44	70
Control:		
In attack	52	78
Of advance	23	20
Phase line	23	20
Coordination:		
And control in combat	52	78
Of reconnaissance agencies	18, 58	18, 88
Of signal communication	80	103
Counterreconnaissance	47	72
Covering detachments	63	91
Crossings, river	69-76	95

	Paragraph	Page
Defense:		
Antiaircraft.....	44	70
Antimechanized.....	45	71
Of a position.....	54	81
Train.....	43	69
Defensive action.....	54	81
Defile, reconnaissance.....	36	33
Delaying action.....	54	81
Depth, rate of advance and frontage.....	20	18
Detachments, covering.....	63	91
Disablement of—		
Communication equipment.....	96	112
Vehicles.....	5	4
Weapons.....	6	5
Dispersion.....	44	70
Disposition of casualties.....	113	122
Drill.....	15	16
Duties of personnel.....	10-14	10
Echelons of maintenance.....	109-110	120
Effect of terrain and weather on operations.....	31	30
Employment of—		
Assault guns.....	60, 68	88
Weapons in combat.....	51	74
Enemy interference with communication.....	95	112
Equipment:		
Communication, destruction.....	96	112
Vehicles.....	5	4
Weapons.....	6	5
Evacuation of—		
Casualties.....	113	122
Prisoners.....	114	123
Fire, reconnaissance by.....	22	19
First echelon maintenance.....	109	120
Flag signals.....	85	104
Flank guards.....	64	91
Frontage.....	20	18
Groupings, tactical, for combat.....	50	73
Guard:		
Advance.....	41, 62	38, 90
Flank.....	64	91
Rear.....	65	92

	Paragraph	Page
Halts, security at.....	42	38
Hostile camp, bivouac, or installation, reconnaissance of..	37	36
Hostile column, reconnaissance of.....	38	36
Information, transmission	25	21
Inspections.....	15	16
Instructions:		
Reconnaissance.....	24	20
To sentinels.....	42	38
Intelligence training.....	7	5
Listening posts.....	30	28
Local procurement of supplies.....	105	118
Logistics.....	97-115	113
Maintenance:		
Communication equipment.....	91	109
Vehicular:		
First echelon.....	109	120
Procedure.....	111	121
Responsibility.....	108	119
Second echelon.....	110	120
March outpost.....	42, 66	38, 93
Marches, security on.....	41	38
Means of signal communication.....	79, 84	103, 104
Means of supply.....	99	114
Measures:		
Antiaircraft security.....	44	70
Antimechanized security.....	45	71
Medical:		
Personnel.....	112	121
Service for the troop.....	112, 113	121, 122
Messengers, use.....	85	104
Methods of—		
Operation.....	17, 57	17, 87
Training.....	9	9
Mission:		
Combat.....	67	94
Of cavalry reconnaissance troop.....	3, 16, 56	2, 17, 86
Of communication.....	77	102
Of signal communication.....	77	102
Reconnaissance.....	59	88
Security.....	39, 61	36, 89
Night reconnaissance.....	32	30

	Paragraph	Page
Objective, training.....	7	5
Objectives, combat.....	49	73
Observation posts.....	30	28
Obstacles; reconnaissance.....	35	33
Offensive, combat.....	48	72
Operation:		
Effect of terrain and weather on.....	31	30
Method.....	17, 57	17, 87
Of platoons.....	28	25
Of reconnaissance teams.....	27	22
Of the troop.....	29	26
Operators, radio.....	99	108
Orders to reconnaissance elements.....	24	20
Organization of cavalry reconnaissance troop.....	4	2
Outpost:		
Bivouac.....	42, 66	38, 93
March.....	42, 66	38, 93
Panels.....	85	104
Personnel:		
Crossing of, over rivers.....	71	96
Duties.....	10-14	10
Medical.....	112	121
Signal communication.....	81	103
Phase lines.....	23	20
Platoon operations.....	28	25
Position, defense.....	54	81
Posts, observation and listening.....	39	28
Prisoners of war.....	114	123
Procedure, in maintenance.....	111	121
Procurement of supplies, local.....	105	118
Purpose of manual.....	1	1
Pyrotechnics.....	85	104
Radio:		
Operators.....	90	108
Use.....	85	104
Rate of advance.....	20	18
Rear guards.....	65	92
Reconnaissance:		
By fire.....	22	19
Instructions.....	24	20
Missions.....	59	88
Night.....	32	30

Reconnaissance—Continued.	Paragraph	Page
Of bridge or defile.....	36	33
Of hostile camp, bivouac or installation.....	37	36
Of hostile column.....	38	36
Of obstacles.....	35	33
Of roads.....	33	31
Of towns.....	34	32
Platoons, operation.....	28	25
Security on.....	40	38
Teams, operation.....	27	22
Troop, operation.....	29	26
Reorganization.....	53	78
Reports.....	26	22
Responsibility for—		
Communication.....	78	102
Supply.....	98	114
Vehicular maintenance.....	108	119
River crossings:		
Communications at.....	74	97
Of personnel.....	71	96
Security at.....	75	101
Vehicles.....	72, 73	96, 97
River lines, combat at.....	76	101
Roads, reconnaissance of.....	33	31
Routes, zones, and areas.....	21	19
Scope of—		
Manual.....	2	1
Training.....	8	6
Second echelon maintenance.....	110	120
Security:		
Advance guards.....	98	114
Against chemicals.....	46	72
At halts and on bivouac.....	42	38
Communication.....	83, 89	104, 108
For river crossings.....	75	101
Local.....	98-106	114
Measures, antiaircraft.....	44	70
Measures, antimechanized.....	45	71
Missions.....	39, 61	36, 89
Of troop train.....	43	69
On marches.....	41	38
On reconnaissance.....	40	38
Sentinels, instructions.....	42	38

Signal—	Paragraph	Page
Communication (<i>see also</i> Communication)	77-96	102
Security	89	108
Smoke signals	85	104
Sound signals	85	104
Standing operating procedure	93	110
Supplies:		
Captured, use	106	119
Local procurement	105	118
Supply:		
Classes	100-104	114
Means	99	114
References	97	113
Responsibility	98	114
Tactical vehicles	5	4
Terrain, effect of on operations	31	30
To disable vehicles	5	4
Town, reconnaissance	34	32
Train, troop, security	43	69
Training:		
Communication	82, 87, 88	103, 106, 107
Intelligence	7	5
Methods	9	9
Objective	7	5
Scope	8	6
Tests	7	5
Transmission of information	25	21
Troop on reconnaissance	29	26
Troop maintenance procedure	111	121
Troop medical service	112, 113	121, 122
Unit mile	102	116
Use of captured supplies	106	119
Utilization of assigned means of signal communication	85	104
Vehicular maintenance, responsibility	108	119
Vehicles:		
Amphibian, use	70	96
Characteristics	5	4
Crossing of, over rivers	72, 73	96, 97
Disablement of	5	4
Maintenance and evacuation	107-111	119
Tactical	5	4
War, prisoners of	114	123

	Paragraph	Page
Warning, antiaircraft	44	70
Weapons:		
Characteristics	6	5
Disablement of	6	5
Employment in combat	51	74
Weather, effect on operations	31	30
Wire communication	86, 92	106, 110
Zones, routes, areas	21	19