

MHI  
Copy 3

FM 5-15

*Capt S.S. Hamilton*

WAR DEPARTMENT

ENGINEER  
FIELD MANUAL

FIELD FORTIFICATIONS

# ENGINEER FIELD MANUAL



## FIELD FORTIFICATIONS

---

Prepared under direction of the  
Chief of Engineers



UNITED STATES  
GOVERNMENT PRINTING OFFICE  
WASHINGTON : 1940

WAR DEPARTMENT,

WASHINGTON, *October 1, 1940.*

FM 5-15, Engineer Field Manual, Field Fortifications, is published for the information and guidance of all concerned.

[A. G. 062.11 (7-30-40).]

BY ORDER OF THE SECRETARY OF WAR:

G. C. MARSHALL,

*Chief of Staff.*

OFFICIAL:

E. S. ADAMS,

*Major General,*

*The Adjutant General.*

## TABLE OF CONTENTS

SECTION I. GENERAL.	Paragraph	Page
Definitions.....	1	1
Employment.....	2	1
Execution.....	3	2
Nature of work.....	4	2
Effectiveness against projectiles and bombs.....	5	3
Natural conditions affecting design and location.....	6	4
Use of existing terrain features.....	7	5
<b>II. TERRAIN APPRECIATION.</b>		
General.....	8	6
Factors.....	9	6
Compartments.....	10	8
Influence of corridors.....	11	12
Influence of cross compartments.....	12	20
Aids to study of terrain.....	13	20
<b>III. ORGANIZATION OF THE GROUND.</b>		
General.....	14	21
Use of hasty fortifications.....	15	23
Use of deliberate fortifications.....	16	25
Battle position.....	17	25
Platoon defense area.....	18	29
Company defense area.....	19	30
Battalion defense area.....	20	31
Regimental sectors.....	21	35
Additional organization.....	22	36
Artillery support.....	23	36
Outpost area.....	24	37
Reserve battle position.....	25	41
Switch positions.....	26	42
<b>IV. EFFECT OF PROJECTILES.</b>		
General.....	27	42
Infantry weapons.....	28	43
Artillery and aircraft.....	29	45
<b>V. TRENCHES.</b>		
General.....	30	60
Trace, tracing, and profile.....	31	60
Necessity for standard types.....	32	61
Classification.....	33	61
Hasty.....	34	63
Deliberate.....	35	68
Drainage.....	36	87
Revetments.....	37	92
Breastworks.....	38	103
Accessories.....	39	105

TABLE OF CONTENTS

SECTION VI. OBSTACLES.	Paragraph	Page
Classification-----	40	117
Basis of location, design, and construction-----	41	117
Barbed wire-----	42	118
Abatis-----	43	149
Inundations-----	44	152
Underwater-----	45	153
Tank-----	46	157
Summary-----	47	157
<b>VII. EMBLEMMENTS.</b>		
Infantry weapons-----	48	158
Artillery-----	49	188
Antiaircraft matériel-----	50	201
<b>VIII. PROTECTED SHELTERS.</b>		
Classification-----	51	206
Choice of type-----	52	209
Overhead cover-----	53	213
Standard construction materials-----	54	219
Surface-----	55	220
Artillery ammunition-----	56	225
Cut-and-cover-----	57	226
Cave-----	58	240
Drainage-----	59	276
Ventilation-----	60	278
Circulation of fresh air-----	61	278
Gasproofing-----	62	279
Air supply during gas attack-----	63	282
Floor space-----	64	283
Time for construction-----	65	284
<b>IX. SUMMARY.</b>		
General-----	66	286
Terrain appreciation-----	67	286
Organization of the ground-----	68	287
Effects of projectiles-----	70	287
Trenches-----	71	287
Obstacles-----	72	289
Emblemments-----	73	290
Protected shelters-----	69	291.
General rules for execution of field works-----	74	292

# ENGINEER FIELD MANUAL

## FIELD FORTIFICATIONS

(The matter contained herein supersedes chapter 2, part two, Engineer Field Manual, volume II (tentative), June 25, 1932; TR 195-5, October 1, 1928; TR 195-50, February 20, 1929; and TR 1195-65, January 28, 1926.)

### SECTION I

#### GENERAL

■ 1. **DEFINITIONS.**—*Field fortifications* are works constructed by military forces in combat operations to increase natural defensive strength of a locality. They are of two general classes—

*a. Hasty*, constructed when in contact or about to make contact with the enemy and consisting generally of such fox holes, open weapon emplacements, and simple obstacles as the situation permits.

*b. Deliberate*, constructed out of presence of the enemy or developed gradually from hasty fortifications as a result of long occupation, and consisting generally of such standard trenches, covered emplacements, obstacles, etc., as the situation requires.

■ 2. **EMPLOYMENT.**—*a. Defense.*—Field fortifications are used in defensive operations to—

- (1) Fortify any position not protected by permanent fortifications.
- (2) Supplement permanent fortifications.
- (3) Provide local security for isolated installations such as coast defense guns.

*b. Offense.*—In offensive operations they are used by—

- (1) Any portions of the force assigned defensive missions, thus increasing their defensive strength and thereby releasing other troops for the offensive.
- (2) Attacking troops making a temporary halt, thereby increasing their resistance to counter attacks.

c. In general, any occupied position should be protected by field fortifications whether in preparation for defensive or in connection with offensive combat. However, the primary use is in defense.

■ 3. EXECUTION.—*a.* In general, field fortifications are laid out and constructed by the troops occupying them.

*b.* In divisions, corps, and armies the unit engineer assists in preparation of plans and in technical inspections to insure carrying out such plans. It is seldom that small units have engineer assistance in the planning or laying out.

*c.* Primary duties of engineer troops in execution are—

(1) Supply of tools and materials.

(2) Execution of works of general use such as command and observation posts, aid stations, etc., for higher units, main communications for supply and evacuation, and water supply facilities. Engineer troops may also assist other units in execution of works for which engineers are better trained and equipped than are the other troops, such as large shelters, obstacles of special nature, special works for drainage, and demolitions.

*d.* Rear positions usually are planned and laid out by the unit engineer under general instructions from the commander. Engineer troops assisted by reserve unit and labor troops, and civilian labor if available, usually execute these works.

■ 4. NATURE OF WORK.—*a.* Work of fortifying a locality consists generally of the following tasks, listed in the order of importance most frequently applicable:

(1) *Hasty.*—The general rule is first to concentrate the bulk of the force on those things which most increase defensive strength of the position.

(*a*) Providing camouflage, limited generally to selection of positions affording natural cover or ease of concealment.

(*b*) Clearing reasonable fields of fire for flat trajectory weapons.

(*c*) Digging open emplacements for machine guns.

(*d*) Digging fox holes (small pits for individual soldier).

(*e*) Erecting obstacles, principally wire entanglements.

(*f*) Digging shallow trenches connecting fox holes when time permits.

(2) *Deliberate.*—The general rule is first to concentrate as much of the force as is necessary on those things which require the longest time.

(a) Adequate communications.

(b) Providing shelter for those working on the position.

(c) Providing camouflage of important installations.

(d) Constructing splinterproof or shellproof observation posts.

(e) Constructing protected shelters for troops, command posts, aid stations, etc.

(f) Constructing splinterproof or shellproof emplacements for infantry supporting weapons.

(g) Constructing standard fire and communication trenches.

(h) Constructing artillery emplacements.

(i) Constructing obstacles of all types, including antitank obstacles.

b. In both hasty and deliberate fortifications, the above tasks are undertaken concurrently so that the position is fairly well coordinated for defense at all times. Provision for camouflage must be made before work is commenced. Camouflage is then carried on continuously throughout the work so that as much of the position as possible is concealed from the enemy no matter when he observes it.

c. Hasty fortifications are developed into deliberate fortifications by deepening and extending trenches, strengthening obstacles, adding protected shelters, etc. This development normally is a continuing process, its extent depending principally upon length of time the position is occupied. As engineers may have to assist in development work, they should be familiar with both hasty and deliberate fortifications.

d. Breastworks and surface shelters are used in place of trenches, dugouts, etc., where natural conditions such as high ground water level or rock prohibit normal excavation.

■ 5. EFFECTIVENESS AGAINST PROJECTILES AND BOMBS.—a. Trenches and open emplacements properly constructed provide effective protection against all small-arms fire, artillery projectiles up to 4 inches in caliber, and fragmentation bombs (usually 20 pounds), except direct hits. Such works can be



destroyed by fire from larger caliber guns or bombing with demolition bombs of 50 pounds or heavier.

b. Protected shelters and shellproof covers can be made effective against the heaviest shells or bombs, but such complete protection is limited to the most important installations only, because of excessive labor and materials involved. Most installations are protected only against light or medium shells and bombs. Degree of protection to be provided for any given installation depends on type, amount, and accuracy of fire or bombing which the enemy is likely to bring to bear on it. The enemy normally will conserve ammunition and save wear and tear on guns and airplanes by directing his heaviest fire and bombing against those installations the destruction of which is most important to him, and which he can shell or bomb with reasonable accuracy and effectiveness. Hence concealment which makes accurate fire against a single installation more difficult, dispersion which makes effective fire against a group of installations more difficult, and deflade which masks flat-trajectory fire should all be used to the greatest extent practicable in order to lessen need for extensive protective works.

■ 6. NATURAL CONDITIONS AFFECTING DESIGN AND LOCATION.—

a. *Surface water* resulting from the run-off of rainfall should be kept out of excavated works by—

(1) Siting them so that natural drainage lines drain away from rather than into them.

(2) Using drainage ditches to divert surface water which would otherwise run into them.

(3) Providing internal drainage to dispose of surface water which enters them.

b. *Ground water* is free water contained in pervious soil. Its upper level is roughly parallel to the ground surface, and is nearest the surface at drainage lines and deepest under hill crests. Its level at any point is the same as the level of water in a shallow well or test hole at the point. It is generally impracticable to excavate for field fortifications below ground water level because of the difficulty of providing adequate drainage (see par. 36).

c. *Rock or hardpan* prohibits excavating for hasty fortifications, and ordinarily requires too much labor to permit excavation for deliberate fortifications.

d. *Sand* or similar material lacking cohesion is very good for hasty fortifications because it is easy to dig, but is poor for deliberate because it requires excessive revetment to make the works reasonably permanent.

e. *Terrain* is the most important feature to be considered in locating field fortifications. A detailed discussion of terrain is given in section II.

■ 7. USE OF EXISTING TERRAIN FEATURES.—a. Field fortification work may be reduced by taking full advantage of all existing terrain features such as woods, cities or towns, brick or stone walls, railroad or highway embankments and ditches, small gullies or folds in the ground, and many others. Such features often may be used in their natural state to provide either concealment or protection from fire or both. In many cases a little labor can convert them into strong defensive works. Such features as houses and walls of brick or stone sometimes assist indirectly by providing a source of materials for field works, thus reducing need for supplies from the rear.

b. Large woods have great defensive value because they afford concealment from enemy observation and are developed readily for protection from hostile fire. On the other hand, small patches of woods draw artillery fire, are particularly subject to gassing, and should be avoided. In defense of woods, concealment offered should be used to take the enemy under fire by surprise. The strongest resistance should be located 100 yards or more in rear of the forward edge of the woods. Major irregularities in the edge of the woods are used to develop flanking fire sweeping it. When clearing woods to develop fields of fire, care should be taken not to destroy concealment, especially from aerial observation. Such clearing should generally be limited to underbrush and lower branches of trees.

c. A large town or city containing masonry buildings may be very strongly organized for defense; however, provision must be made for protection against heavy shell fire and aerial bombs, and against gas because of the excellent target provided. Buildings provide concealment and protection for

riflemen and machine guns, cellars and heavy walls provide shelter which can be reinforced against artillery, and higher buildings afford means of observation. Thus an excellent combination of fire and obstacles may be obtained. Because they are easily set on fire wooden buildings are of little defensive value. Small villages or isolated buildings draw concentrated artillery fire and should therefore be avoided.

## SECTION II

### TERRAIN APPRECIATION

■ 8. GENERAL.—*a.* Terrain is an area of ground considered as to its extent and topography in relation to its use for a particular military operation. From either direct observation or study of maps and aerial photographs the eye gets a picture of the ground with its drainage systems, commanding elevations, wooded and open areas, and works of man. Terrain appreciation is the evaluation of this picture to determine effect of the terrain on lines of action open to opposing forces in the area.

*b.* By reason of his specialized training the unit engineer is the terrain specialist on the unit commander's staff. As such he must understand effect of terrain upon military operations and must be prepared to make recommendations thereon at all times, particularly in defensive operations. The purpose of this section is to describe means of evaluating and to show effects of terrain on tactical dispositions.

■ 9. FACTORS.—*a.* Terrain is always evaluated in terms of five factors: observation, fields of fire, cover and concealment, obstacles, and communications.

(1) *Observation* of the battle area is necessary for effective combat. Points of commanding elevation form the framework for fire-control systems, and observation is essential to have effective fire. It is of great importance to artillery in fire adjustment, and is important not only because it makes effective fire possible, but also because it enters largely into influence of the four other terrain factors. Fields of fire obviously need local observation for effective use; value of cover is based on denial of observation to the enemy; obstacles should be observed so that fire may be brought to bear on

any enemy stopped by them; and routes of communication are the more useful the more the enemy can be denied observation thereof. Hence, observation and denial of observation are used as the basis for the method of studying terrain described in paragraphs 10-12 below.

(2) *Fields of fire* are essential to defense. An ideal situation exists where terrain offers an open stretch of ground over which the advancing enemy may be brought under effective fire of infantry weapons. Fields of fire may be improved by cutting or burning weeds, grass, and crops; by clearing brush and trees; by demolishing buildings; and by cutting lanes through woods, but concealment must be considered in each instance. Time and labor available for such improvement should be considered in evaluating terrain.

(3) *Cover and concealment* includes protection from fire provided by accidents of terrain, and that provided by other natural or artificial means. Concealment from view, from both air and ground, affords cover only so long as the enemy does not know that the natural or artificial features are occupied. Cover is important to both attack and defense.

(4) *Obstacles* aid defense by hindering the attacker's movements, preferably by halting him under effective fire. Rivers, streams, ponds, gullies and steep banks, and lakes are some of the common natural obstacles which may be utilized to advantage. A stream with a depth over five feet is particularly effective against mechanized vehicles. No opportunity for providing obstacles to mechanized attack should be overlooked. Where natural obstacles are lacking artificial ones usually can and should be prepared.

(5) *Communications* (that is, roads, railroads, waterways and airway facilities) are important to both offense and defense. Small bodies of troops may move off roads, but in some situations, especially in operations of large bodies of troops, the means of communication may be of vital importance.

b. Every line of tactical action in a given situation is analyzed with respect to pertinent terrain features. Advantages and disadvantages of each such feature upon any particular line of action constitute as a whole the relative effect of terrain in comparison with its effect on other possible lines of

action. Modification of the situation may completely change influence of terrain features and so affect plan of action which should be adopted. Therefore, effect of terrain must always be studied in connection with the mission and the situation of the enemy and of our own forces.

■ 10. COMPARTMENTS.—*a. Definition.*—Based on observation as the decisive factor, a basic unit called "terrain compartment" is considered in studying terrain. A terrain compartment is an area inclosed on at least two sides (opposite sides) by critical terrain features which prevent ground observation into the area. The limiting features are usually ridges or high ground, but may be woods, cities, towns, or wide bodies of water.

*b. Form.*—Compartments may be of any size or shape. They may be simple or complex with the interior subdivided into smaller compartments. Limiting features at the edges may be high or low, continuous or discontinuous. A compartment may be screened on only two sides or on all sides. The illustrative examples in this section are based on the simplest forms but the fundamentals discussed apply to all types.

(1) A terrain compartment in its simplest form is shown in figure 1①. The figure shows three ridges, ABC, DEF, GHI, separated by two valleys, JK and LM. Based on the definition, the area ACFD is a terrain compartment. The boundaries are selected so that from outside them no portion of the compartment can be observed. Therefore the boundary runs along the topographic crest of the adjacent ridges.

(2) In figure 1 ② boundaries of the compartments are ridges. In figure 1 ③ there are no ridges but there are strips of woods along the general lines AC and DF, and a town along GI. They form two terrain compartments since the woods and town limit observation just as effectively as the ridges. Actual boundaries of the compartments, that is, the limiting lines of observation, lie not at the edge of the woods or town but far enough back from the edge to shut off observation over the open ground beyond.

*c. Significance.*—(1) While division of terrain into compartments is based upon observation, the real significance is that from points outside their boundaries it is difficult to bring effective fire to bear upon forces within the compart-

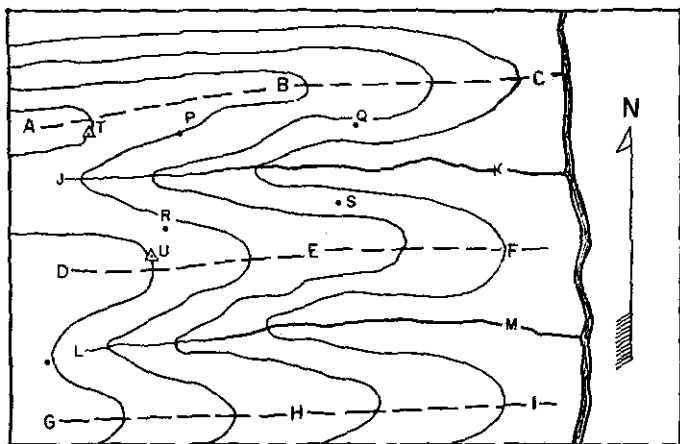

① Formed by ridges

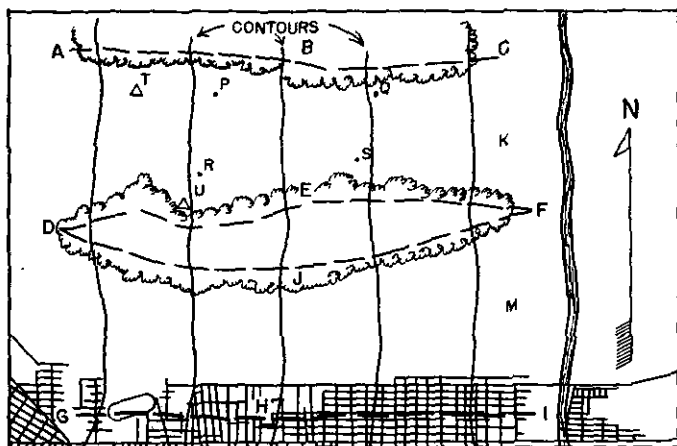

② Formed by woods and town.

FIGURE 1.—Terrain compartments.

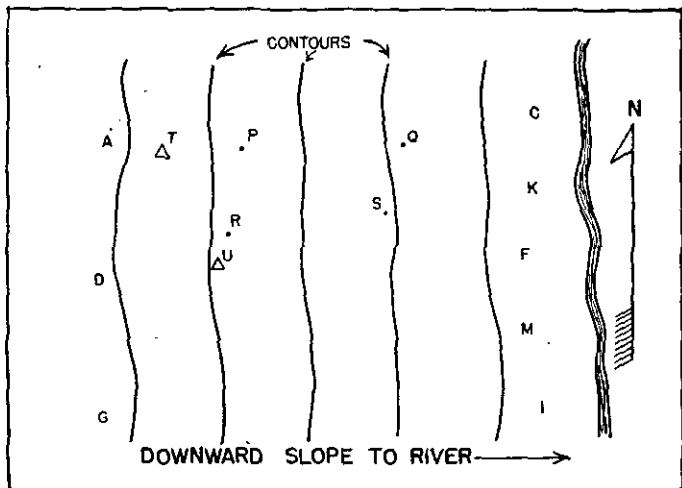

FIGURE 2.—Absence of terrain compartments.

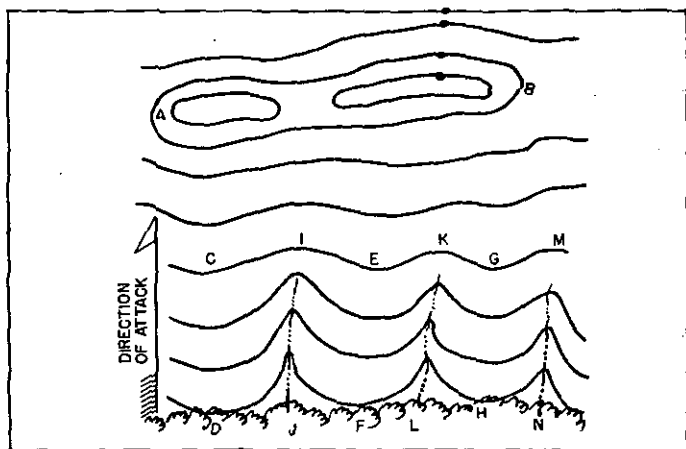

FIGURE 3.—Common terrain condition.

ments. In figure 1 ① and ② machine guns at P, Q, R, or S can fire upon any forces within compartment ACFD, but they cannot fire effectively with direct laying upon any forces in the adjoining compartment DFIG, because machine gun personnel cannot see such forces. For the same reason, artillery observers at T or U can bring observed fire to bear upon any forces within compartment ACFD, but not upon forces in adjoining compartment DFIG. Similarly, machine gunners and artillery observers within DFIG are obliged to confine their observed fire to forces within that compartment since they cannot see beyond it. Hence the fundamental characteristic of terrain compartments is that they limit observation and thereby decrease possibility of observed fires from outside compartments.

(2) Figure 2 represents the same sized area as figure 1 ① but instead of the two stream valleys and three ridges of figure 1 ① there is a fairly uniform slope from the line ADG downward to the river. The contours are nearly straight, parallel, and at about equal intervals. No longer is the fire power within the area ACIG divided into two groups by terrain compartments. With terrain conditions as shown in figure 2 there are no compartments and all of the fire power within the area ACIG can be brought to bear upon any part of the area. Machine gunners at P, Q, R, and S and artillery observers at T and U can observe and hence place their fire anywhere within the area ACIG. Therefore a better organized, more flexible system of fire is possible where there are no terrain compartments than is possible where they break fire power up into groups to support each other. This is the fundamental idea underlying influence of terrain compartments upon tactical operations.

(3) A common terrain condition is that shown in figure 3. A main ridge, the top of which is along the line AB, is cut by the gullies IJ, KL, and MN, leaving ridges CD, EF, and GH. These ridges form the boundaries of two compartments, CEFD and EGHF, ending at about the line CM. Above that line a defender can organize his fires for mutual support across the entire area ABMC; below the line CM he is limited in the lateral organization of his fire by the compartments CEFD and EGHF. These compartments are subdivi-



sions of a larger compartment, ABND, bounded by the ridge AB and the woods DN.

*d. Classification.*—(1) Terrain compartments are classified with respect to direction of movement of forces operating therein as—

(a) *Corridors*, when the longer dimension lies generally in the direction of movement or leads toward an objective.

(b) *Cross compartments*, when the long axis of the compartment lies across the direction in which a force is moving, or is parallel to the front.

(c) *Oblique compartments*, when the compartment is oblique to such direction or front.

(2) To illustrate:

(a) In figure 1 ① a force advancing westward from the vicinity of the point K calls compartment ACFD a corridor. A force advancing north from the valley LM would call the same compartment ACFD a cross compartment. These two terms, corridor and cross compartment, do not define compartments that differ in a physical sense; the compartment is the same in both cases, namely, the area ACFD. The difference lies in the direction of the main axis of attack and defense with respect to the main axis of the compartment. If attack comes from east or west, both attacker and defender would call ACFD a terrain corridor; if attack comes from north or south, both attacker and defender would call ACFD a cross compartment.

(b) In figure 3, with the direction of attack as shown, CEFD and EGHF' are corridors within the cross compartment ABND.

■ 11. INFLUENCE OF CORRIDORS.—*a. In attack.*—(1) In general, a corridor favors attack because it limits lateral organization of the defender's fire. This does not mean that it gives the attacker an advantage over the defender; it merely means that it gives the attacker an advantage that he would not have if there were no terrain corridors since he will be subjected to a lesser density of fire than otherwise would be the case. Therefore, the attacker seeks to utilize corridors wherever they exist.

(2) Where terrain is the decisive factor, boundaries between tactical units in attack should coincide with boundaries

of corridors. The reasons for this fundamental are illustrated by the following example:

(a) In figure 4 both ① and ② show two corridors, HILK and IJML, each assumed to be a suitable width for a regiment in attack. In ① the boundaries between attacking regiments are located along centers of the corridors; in ② the boundaries between attacking regiments coincide with the boundaries of the corridors.

(b) In figure 4 ① the 1st Infantry has attacked and reached the dotted line near the center of the figure. As the attack spearhead near D appears to be the major threat, enemy machine guns on the slope BC and along the edge of the woods between F and J begin firing on the flanks of the 1st Infantry; an artillery observer on the slope to the right of H places fire on the left flank of the 1st Infantry. These fires, in addition to those from within the zone of action of the 1st Infantry, may prove sufficient to stop the attack. The regiments attacking on the right and left of the 1st Infantry will cooperate, but if one of them succeeds in making a threatening advance, the defender can shift some of the fire from the zone of the 1st Infantry to aid in stopping it.

(c) In figure 4 ② the 1st Infantry has again advanced to the dotted line. However, the situation now differs materially from that shown in figure 4 ①. Because the boundaries of the 1st Infantry coincide with the boundaries of the corridor HILK, the defense cannot bring to bear against the 1st Infantry any direct or observed fire from outside the corridor. As long as the 1st Infantry can continue to overcome the defensive fires within its own zone of action, that is, within its own corridor, it can continue to advance, and by flanking attacks to right and left it can materially aid advance of its neighbors.

(3) Boundaries in attack usually extend at least from the line of departure to the terrain features designated as the objective or objectives.

*b. In defense.*—(1) The backbone of defense is organized fire of automatic weapons supplemented by observed artillery fire. Corridors entering a defensive portion break it up so that fire power used to defend one corridor cannot be used to assist in defending any other part of the position. There-

fore the defender seeks a position without corridors because they weaken his defense by decreasing flexibility of his fire.

(2) In general, from the standpoint of the most advantageous use of terrain, boundaries between units in defense should neither follow the edges of corridors nor the lines of probable enemy approach, but should be situated somewhere between the two in such a manner as to secure unity of command along the most dangerous avenue of approach. The reasons for this are illustrated by the following example:

(a) Figure 5 ①, ②, and ③, shows three different methods of assigning boundaries, the terrain being the same in all figures. Figure 5 ① shows sector boundaries coinciding with

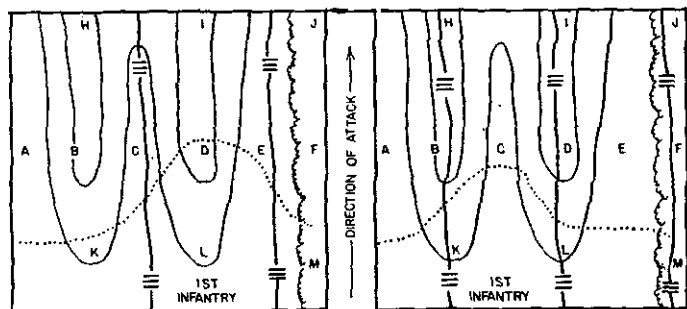

① Boundaries in centers of corridors (wrong).

② Boundaries at edges of corridors (right).

FIGURE 4.—Corridors in attack.

boundaries of corridors as is proper in attack. Figure 5 ② shows sector boundaries following lines of probable enemy approach within the corridors. Figure 5 ③ shows sector boundaries placed between those shown in ① and ②. In each case it is assumed that the boundaries mark off frontages which can be defended by an infantry battalion. Proper defense of the area requires that the ridges through A, B, and C be organized for strong all around defense; the valleys between the ridges being defended by flanking fire from the ridges and by frontal fire from the rear portions of the position. Location of sector boundaries is important because

these boundaries allocate responsibility among the unit commanders concerned.

(b) In figure 5 ① the sector boundaries pass through the ridges at A, B, and C, which should be well organized. Two commanders, each defending half of the ridge BO, cannot

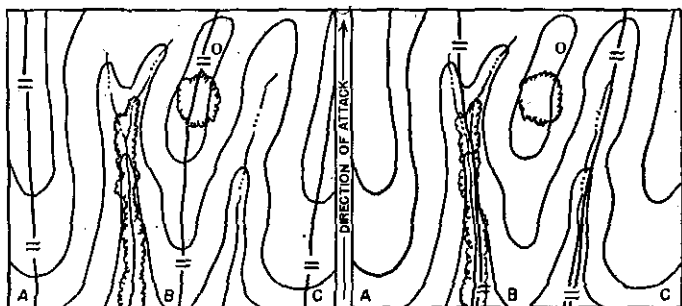

① Boundaries along ridges (wrong).

② Boundaries along valleys (wrong).

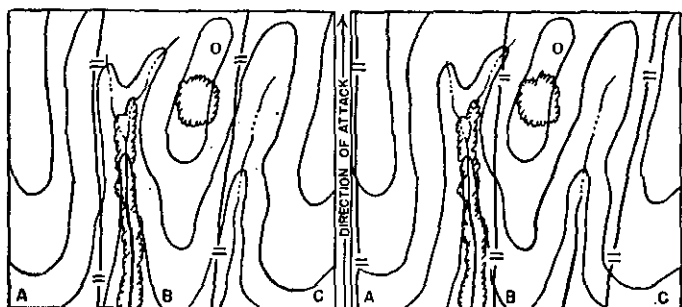

③ Boundaries between ridges and valleys (right).

④ Boundaries excluding routes of approach (wrong).

FIGURE 5.—Corridors in defense.

do it as effectively as one commander who directs the defense of the whole ridge. The same thing applies to the ridges at A and C. It is true that the valley between A and B which is a probable avenue of approach for the attacker is entirely under control of the commander of the 1st Battalion, but his

main reliance for defense is not upon the head-on opposition that he can offer to the attacker's approach up the valley but on the flanking fire made possible by continued possession of the organized localities at A and B.

(c) In figure 5 ② the ridges at A, B, and C are each placed under control of a single commander by establishing boundaries in the stream beds, that is, along the lines that the attacker will probably seek to penetrate. Thus one source of weakness, namely, division of responsibility for maintaining possession of high ground, has been eliminated but another source of weakness has been introduced. The valley is the probable route of approach of the attacker; he will seek to penetrate the valley and then reduce the high ground by flanking attacks. Putting the boundaries in the valleys divides the responsibility for stopping the enemy advance up the valleys. One commander can accomplish it more effectively than two. Unity of effort requires giving this responsibility to one commander.

(d) In figure 5 ③ the boundaries are drawn neither along the ridges nor along the stream beds, but somewhere between the two. The commander of the battalion defending ridge B in this case has full control both of forces holding the ridge at B and of those opposing advance of the enemy up the valley between A and B. Cooperation will still be necessary; he will expect to receive assistance from the battalions on his right and left. But the boundaries along which this cooperation must be arranged do not in this case pass through either of the two important terrain features, the ridge and the valley adjoining it. A boundary line is always a line of weakness, but by drawing the boundaries as they are shown in ③ this weakness is much less serious to the defense than it is if the boundaries are drawn as shown in ① or ②.

(e) Figure 5 ④ shows the same terrain as ①, ②, and ③ but with the sector boundaries located to the right of the streams instead of the left. This alternate arrangement of boundaries appears at first glance to be as satisfactory as that shown in ③ since the boundaries divide neither the ridges nor the valleys between two commanders. The wooded valley between A and B, however, is more of a threat to the battalion defending the ridge through B. It offers opportunity

for an attacker to advance up the valley by using the woods for cover, capture the woods on the top of the ridge near O, and then capture the entire ridge from O to B by attacking downhill from the rear. The commander of the battalion defending BO therefore has the greater interest in defense of this approach, and its defense should consequently be assigned to him by drawing the boundaries as they are shown in ③ rather than as shown in ④.

(3) The preceding considerations apply particularly to those portions of the boundaries within the position and at the shorter ranges to the front. It may be found that their continuation to the front at the longer infantry ranges involves use of terrain differing from that in the close-in defense. For example, in figure 6 the boundary AB is properly located for close-in defense. In extending this boundary to the front in order to place responsibility for longer range fire it would, following the same considerations that led to establishment of boundary AB, extend forward through F, G, and H. Then enemy machine guns at X and Y are in the sector of the 2d Infantry and should be covered by the fire of that unit. However, the deflade provided by the ridge CDE prevents the 2d Infantry from firing on X and Y, and also prevents guns at X and Y from firing into the sector of the 2d Infantry. The guns at X and Y can fire into the sector of the 1st Infantry, and can be covered by fire from the 1st Infantry. If the boundary is shifted to CDE instead of FGH, responsibility for taking care of these machine guns is placed where it belongs, namely, on the 1st Infantry. The ridge CDE is utilized properly from the standpoint of terrain when the boundary line between the 1st Infantry and 2d Infantry is drawn along the top of the ridge, thus giving to the 1st Infantry the east slope in which it has a paramount interest, and to the 2d Infantry the west slope in which it has a paramount interest.

(4) The same considerations apply when boundaries of terrain compartments are formed by villages or woods instead of by ridges. In figure 7 the village and woods are important features of the terrain. Responsibility for their defense should therefore not be divided as it is in ① but should be placed under a single commander as shown in ②. (An at-

tacker would locate his boundaries as shown in ①, that is, along edges of the corridor formed by the village and woods.)

c. *Extension of boundaries.*—At longer ranges to the front, boundaries are intended primarily to coordinate artillery fires and will be influenced by location of possible hostile assembly areas and routes of approach. Such boundaries extending

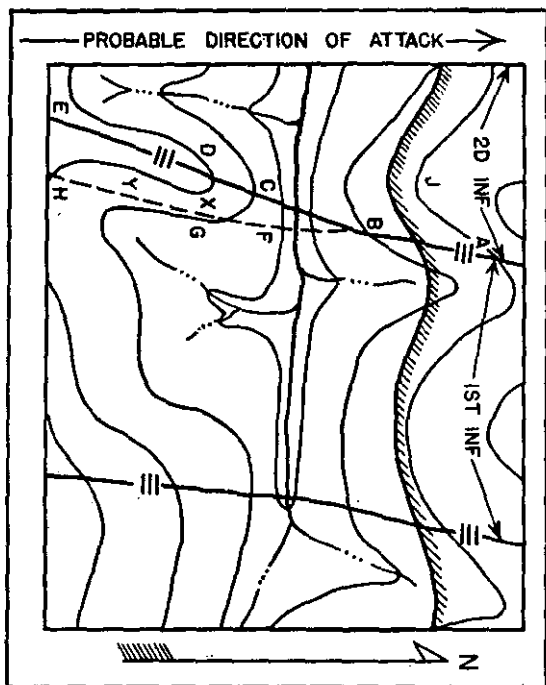
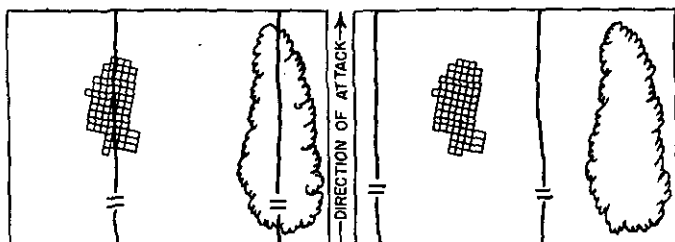

FIGURE 6.—Extension of boundaries.

sectors to the limits of artillery fire in front of defensive positions frequently are placed along the crests of ridges. The extension of boundaries to the rear in both attack and defense is influenced largely by the location of routes of communication essential to supply and movement within the sector.



① Wrong.

② Right.

FIGURE 7.—Corridors between woods and villages in defense.

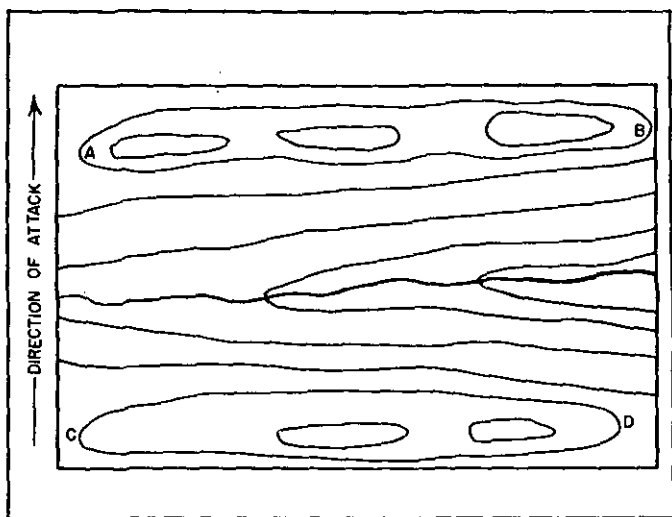

FIGURE 8.—Cross compartment.



**■ 12. INFLUENCE OF CROSS COMPARTMENTS.—***a. On defense.—*

In figure 8 the ridge AB is one boundary of cross compartment ABDC. The observation available to the defender from this boundary is very valuable; consequently he should dispose his forces well to the front of it in order that local successes by the attacker may not result in loss of so valuable an asset. The cross compartment as a whole is a valuable asset to defense because mutually supporting fires can be organized across its entire length from AC to BD. Until the defender is actually driven from the line AB he retains his observation over the entire area. In general therefore a cross compartment favors the defense and handicaps the attack.

*b. On attack.—*Boundaries of cross compartments form natural objectives for attack or limited objectives along the line of attack. Until the entire area ABDC has been captured and the defender driven beyond the ridge AB, the attack or at any rate this particular phase is not complete. When the ridge has been taken the attacker may have a breathing spell in which to reorganize his forces, move his observers forward to points from which they can see into the adjoining cross compartment, and make his plans for the next phase of the attack which will be capture of the next cross compartment in its entirety.

*c. Unit boundaries.—*From a terrain standpoint, the boundaries between attacking units may be located with equal effect anywhere between AC and BD. There will of course be other factors such as known disposition of defending forces that will influence location of boundaries between attacking units, but the terrain is so uniform over this particular area that its influence on boundaries is negligible. The boundaries between sectors in the defense can also be placed anywhere, as unit commanders can cooperate along one line just as well as along another. In other words, there are no terrain features that limit lateral visibility so location of boundaries between units would be determined by factors other than terrain.

**■ 13. AIDS TO STUDY OF TERRAIN.—***a. Drainage lines and ridge lines form the natural basis for the study of terrain with respect to shape of the ground. When such study of*

ground forms is made on a map or aerial photograph it can be aided materially by—

(1) Emphasizing drainage lines by marking heavily (fig. 9 ①).

(2) Drawing in heavy lines along crests of ridges, called "ridge-lining" (fig. 9 ②).

(3) (On contoured maps.) Emphasizing certain contours with heavy lines (fig. 9 ③) or coloring map areas between contours with different colors to make ground forms and commanding elevations more apparent. (See TM 5-220.)

b. Drainage lines always form a connected system or systems of branching lines. Ridge lines form similar systems of branching lines since spurs and the smaller ridges branch off from large main ridges just as small streams and gullies branch off from the main streams. Drainage lines and ridge lines thus form two interlocking, branching systems which either singly or together indicate clearly the general shape of the ground. When both systems are emphasized on a map or photo, different colors should be used, preferably blue for drainage lines and brown for ridge lines to conform to usual map colors. The more important ridge or drainage lines may be given special emphasis by drawing them in heavier lines.

c. It will occur frequently that ridge lines and drainage systems are not the only terrain features of outstanding importance in a tactical situation. There may be forests, towns, railroads, etc., to which particular attention must be paid. In such cases these features may be emphasized in much the same ways as described above for ridge lines and drainage systems.

d. Further details regarding tactical study of terrain, together with a form therefor, are given in FM 101-5.

### SECTION III

#### ORGANIZATION OF THE GROUND

■ 14. GENERAL.—a. Organization of the ground is the development of a defensive position to its full strength by—

(1) Providing fields of fire for all flat trajectory infantry weapons.

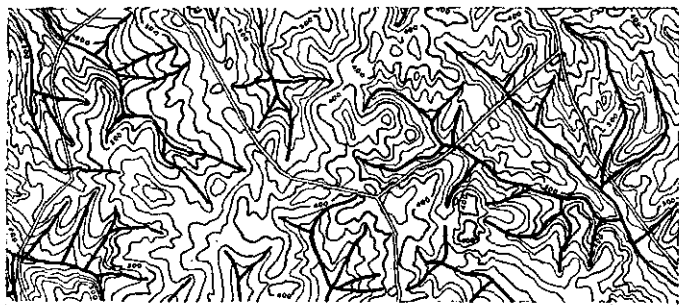

① Emphasizing drainage.

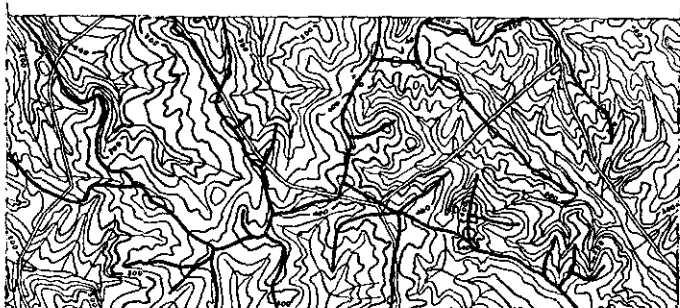

② Ridge-lining.

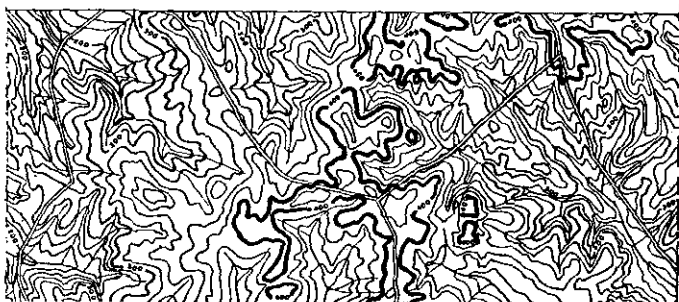

③ Emphasizing contours.

FIGURE 9.—Map aids to terrain studies.

(2) Constructing field fortifications, including such camouflage thereof as is practicable.

b. A defensive position, properly organized, consists of a system of mutually supporting defensive areas organized in depth. Depending on the time, materials, and labor available, either hasty or deliberate fortifications may be used. However, the fundamentals of location and layout of the defensive areas, and the limitations as to their frontages and the intervals between them apply whether hasty or deliberate fortifications are used.

c. Drawings in this section are diagrammatic only. Actual dispositions of units must be adapted to terrain.

d. The types of trenches, wire entanglements, etc., referred to in this section are described in detail in sections V, VI and VII.

■ 15. USE OF HASTY FORTIFICATIONS.—a. In organizing the ground, infantry troops normally will work either under fire from the enemy or under threat of such fire being delivered within a few hours of starting work. Hence work done under these conditions should be such as to provide the greatest possible defensive strength for the position in the shortest possible time. To accomplish this, hasty fortification works of the following types are used:

(1) *Skirmisher trench*.—See paragraph 34 b and figure 22.

(2) *Foxhole*.—See paragraph 34 c and figure 23.

(3) *Shell hole position*.—See paragraph 34 d and figure 24.

(4) *Slit trenches*.—See paragraph 34 e and figure 25.

(5) *Shallow connecting trench*.—See paragraph 34 f and figure 27.

(6) *Machine-gun emplacements*.—See paragraph 48 d and figures 89, 90, and 91.

(7) *37-mm gun emplacements*.—See paragraph 48 d and figures 92 and 93.

(8) *60-mm and 81-mm mortar emplacements*.—See paragraph 48 d and figures 94 and 95.

(9) *Clearing fields of fire*.—This consists usually of clearing underbrush and small trees and the lower limbs of large trees to a depth of at least 100 yards in front of the position, with lanes for machine-gun fire extending considerably farther (see par. 35d).

(10) *Obstacles.*—Barbed wire entanglements form the major obstacles against foot troops. The double-apron fence (see par. 42c (4) and figs. 75 and 76) is the most efficient type, but where time is short or materials lacking, the four-strand fence (see par. 42c (6) and fig. 80) may be used. Provision of antitank obstacles will ordinarily be limited to improvement of natural obstacles as streams, ditches, etc., and laying antitank mine fields.

(11) *Camouflage.*—Camouflage to be effective must be executed simultaneously with the defensive works. Spoil should be properly disposed of as soon as dug; parapets should be sodded as fast as they are finished; emplacements

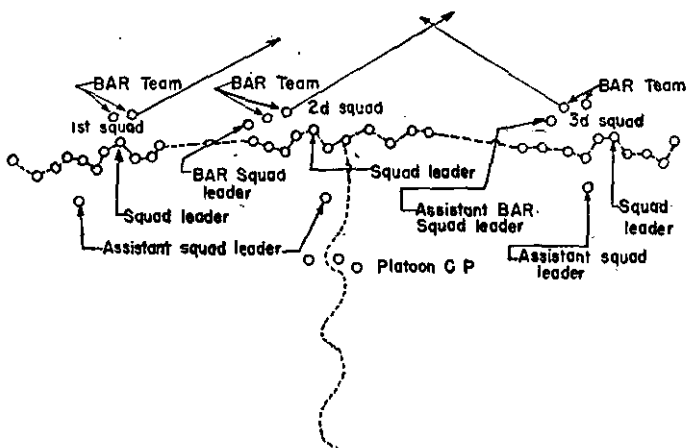

FIGURE 10.—Rifle platoon in fox holes with connecting trenches (12-man squads).

should be concealed under fishnets or natural materials from the start, and paths pointing to defensive works should be avoided (see FM 5-20).

b. Clearing fields of fire is of first priority; however, in most instances a small detail can complete the clearing while some of the men dig fox holes, others prepare emplacements, etc. It usually will be advisable to start placing obstacles early in the work. Thus an enemy attack will encounter a fairly well-organized position. As more time becomes available, the initial hasty fortifications are gradually developed

into deliberate fortifications. Fox holes and shallow connecting trenches are converted into standard fire and communication trenches; open emplacements are changed to covered types; existing obstacles are strengthened and new obstacles added; protected shelters for personnel are provided, etc.

■ 16. USE OF DELIBERATE FORTIFICATIONS.—*a.* In the case of defensive positions organized in rear areas out of contact with the enemy, the fortifications constructed normally will be of the deliberate type with no attempt being made first to provide hasty fortifications and then develop these into deliberate fortifications. The initial work will consist at least of standard fire trenches, open-standing or splinterproof weapon emplacements, complete double-apron entanglements, adequate antitank obstacles, and clearing extensive fields of fire.

*b.* Description of various defensive areas given in the following paragraphs is based on use of deliberate fortifications in a rear position. The work indicated is the minimum consistent with an adequate defense. These descriptions may be applied to defensive areas utilizing hasty fortifications by allowing for the fact that fox holes will be used in place of fire trenches, that the belts of obstacles will be comparatively incomplete, and that weapon emplacements will all be of the open shallow or standing types.

■ 17. BATTLE POSITION.—*a. Definition.*—In defense of a position, troops are distributed along the front within a zone which is called the battle position. This is the position of principal resistance in defense consisting of a system of mutually supporting defensive sectors and areas disposed in breadth and depth. Each sector and area has a definite assignment of troops and a definite mission.

*b. Organization.*—(1) *Depth.*—A battle position should be organized in depth for two reasons:

(*a*) A single line of defense could be penetrated easily and the attacker would then be able to destroy vital installations in rear on which defending troops depend in order to fight. Instead of a single line the defense must present a series of resisting areas which the attacker will have to penetrate successively with increasing resistance before he can reach these installations.

(b) Depth in the battle position makes possible dispersion of the defending force so that the enemy cannot cover all parts of the position with fire at one time.

(2) *Occupation*.—A battle position cannot be occupied economically with equal density throughout its length. One of the major advantages of defense is that it permits holding extensive fronts with relatively weak forces. This is accomplished by actually occupying only certain portions of the front and covering gaps between occupied portions with fire. Occupied portions are called defensive areas. They are placed so that they can support each other with fire so that—

(a) Frontal fire from any one defensive area can be reinforced by flanking fire from neighboring areas.

(b) If a defensive area is occupied by the enemy, fire can be directed into it from the neighboring areas.

*c. Influence of terrain*.—(1) *Factors*.—Location and layout of a battle position depend largely upon the tactical situation and upon the terrain. The influence of terrain may be summarized under headings corresponding to the five terrain factors (see par. 9) as follows:

(a) *Observation*.—Since effectiveness of defensive fire depends primarily on observation, the defense selects ground which affords good observation. The battle position should then be located so as to protect that observation.

(b) *Fields of fire*.—Existing and available fields of fire determine the strong areas and weak points and thus dictate where to put troops and in what strength.

(c) *Cover*.—All elements of a battle position must use cover for protection against enemy fire and observation as an essential means of conserving the fighting capacity of troops in prolonged occupation of a position, and to attain effect of surprise through concealment of location of principal works and reserves. Each element of a battle position should take advantage of natural cover wherever possible in order to reduce the need for constructing artificial cover.

(d) *Obstacles*.—A battle position should be located so as to take advantage of natural obstacles particularly against mechanized attack to help stop the enemy, thus reducing need for artificial obstacles. Not infrequently the commander selecting the main line of resistance may have to decide

whether a natural obstacle or observation is the most important consideration.

(e) *Routes of communication.*—A battle position should be located so as to use existing roads, railroads, and other routes of communication as far as possible to meet its supply and evacuation requirements, and thus reduce need for new construction.

(2) *Critical features.*—Whether it is a point affording commanding observation or whether some other element of terrain, there may be some terrain feature whose possession by us or denial to the enemy will result directly or indirectly in accomplishment of an important step in the plan of operations. Such a feature is termed a critical point. For example, a critical point may be a feature which is especially important for subsequent parts of the maneuver, or it may be a sensitive point the capture of which by the enemy may lead to breaking up our whole defense.

(3) *Features vital to success of mission.*—If a critical point is of such outstanding importance that its possession by us or denial to the enemy will result in accomplishment of the mission or its loss in failure of the mission, then it may be said to be vital or essential to success of the mission. Such a tactical locality is termed a key point. The importance of such a feature may result from its having been named in the mission or in orders, or the importance may be deduced from a study of the terrain. On the other hand, there may be no such feature. When there is such, it is frequently a logical objective of the enemy's main attack either directly or by outflanking, or it may be the terrain feature which is the object of the main effort of the defense.

d. *Composition.*—A battle position is subdivided into defensive areas in such a way as to conform to subdivision of the defending force into tactical units. This permits each defensive area to be occupied by a single tactical unit of appropriate size, and provides for unified control of groups of defensive areas through the normal chain of command (see fig. 11).

(1) The platoon defense area is usually the smallest defensive area. The company defense area, the next largest defensive area, is a group of platoon or smaller defense areas



under control of the company. A battalion defense area is a defensive area composed of a group of company defense areas under control of the battalion commander. A regimental defensive area is a group of battalion defense areas under regimental control, and is called a *regimental sector*.

(2) A line at the forward boundary of the battle position designated to coordinate the defensive fires of all units and supporting weapons is called the *main line of resistance (MLR)* (see fig. 11). In rear of company defense areas

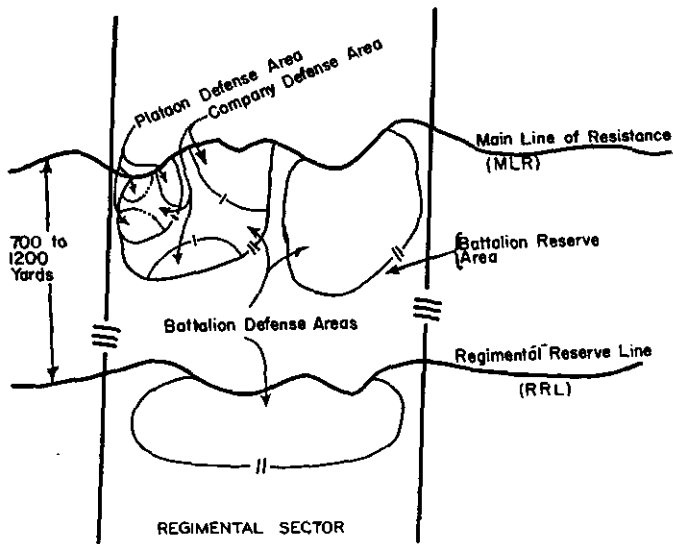

FIGURE 11.—Composition of battle position.

on or near the main line of resistance may be company defense areas forming battalion reserves. A line designated to coordinate the locations and actions of the regimental reserves in the battle position is term the *regimental reserve line (RRL)*.

(3) The defense areas assigned units in defense will vary with mission of the command, natural defensive strength of the ground, importance of the sector to the defense as a

whole, degree of control required, and number and strength of units available for the whole defense.

■ 18. **PLATOON DEFENSE AREA.**—*a.* A platoon defense area is organized for all around defense. It may consist of one fire trench for each squad in the area and a belt of obstacles, usually wire entanglements, entirely surrounding the area. It is not normally organized in depth, the squad trenches being roughly in line rather than one in rear of the other (see fig. 12).

*b.* The frontage which can be defended depends on many factors including mission, size of the unit assigned thereto, and terrain. See Table I which is furnished as a general guide only.

TABLE I.—*Frontage (in yards)*

Size of unit defense areas	Minimum (heavily wooded terrain)			Maximum (flat, open terrain)		
	Interval between defense areas	Frontage actually occupied	Total front defended	Interval between defense areas	Frontage actually occupied	Total front defended
1 squad (12 men).....	25	30	55	100	50	150
Platoon, less 1 squad (2 squads)...	50	75	125	150	100	250
Full platoon (3 squads).....	100	100	200	200	200	400

*c.* Each defense area should be able to cover by fire its own front, the fronts of adjacent defense areas, and the unoccupied intervals between them. Hence, squad trenches on the flanks of a platoon defense area may be faced partly toward adjacent areas to facilitate such flanking fire. Each squad trench should provide at least 5 lineal feet per man. The simple standing fire trench, preferably with the octagonal trace, represents minimum protection to be provided by squad trenches when time and conditions permit.

*d.* The purpose of the belt of obstacles surrounding a platoon defense area is to prevent the trenches being rushed or surprised by foot troops. Such an obstacle must be close

enough to the trenches to be under observation and fire at all times, especially at night, but must not be so close as to permit an enemy to approach within hand grenade range of the trenches. A distance of from 30 to 100 yards from the trenches generally will be suitable. The obstacles should at a minimum consist of the four-strand fence or its equivalent. When the interval between defensive areas is small the obstacles on the flanks will be less than 30 yards distant from the trenches. Obstacles should be concealed so that the enemy is surprised by them.

e. Squad trenches should be provided with clear fields of fire throughout the width of their assigned sectors at least as far forward as the belt of obstacles and preferably to a greater distance.

■ 19. COMPANY DEFENSE AREA.—a. The platoon defense areas of a company defense area are located with a view to resistance to the front and flanks and if necessary to the rear. A company defense is normally organized for a protracted all around defense.

b. A company can defend a front of from 400 to 600 yards, depending on terrain. The portion of this front which is actually occupied is generally not less than 200 yards in width by 100 yards in depth in order to minimize losses from enemy fire, and not greater than 400 yards in width by 300 yards in depth in order to avoid undue dispersion.

c. *Supporting weapons.*—(1) Light machine guns are placed within platoon defense areas in accordance with the battalion plan of fire (see par. 20 e.) The guns may be sited individually for employment on separate missions. They should be provided with open standing type emplacements carefully concealed, with alternate emplacement for each gun from which its primary fire mission can be accomplished.

(2) The 60-mm mortars may be located in a single group within a company defense area far enough forward to have observed fire and at a point where they have natural defilade from the front, or they may be placed in platoon defense areas in accordance with the battalion plan of fire. Where no natural defilade exists, they should be put in open emplacements and provided with an approach trench for ammunition supply. In any case they should be concealed. It

is not essential that they be within a platoon defensive area but they should either have front and flank protection by fire from nearby platoon defensive areas or should be surrounded by obstacles.

*d.* The belts of obstacles around the platoon defensive areas are connected so as to form a belt of obstacles completely around the company defensive area effective against foot troops and located so that it can be covered by fire throughout, particularly by flanking fire from the light machine guns.

*e.* The company command post should be located in a sheltered position such as a ditch or ravine providing protection from small-arms fire and concealment from view. It must be easily accessible to all elements of the company and to battalion headquarters and is therefore generally located in the rear part of the defensive area. Both the command post proper and all routes of approach thereto should be concealed.

*f.* The company observation post should be located near the command post and should afford a view of all or the greater portion of the defensive area and the ground in front thereof. Both the observation post and the approach thereto should be concealed.

■ 20. BATTALION DEFENSE AREA.—*a.* The company defense areas in a battalion defense area are usually disposed laterally and in depth.

*b.* The rifle battalion ordinarily is the smallest unit whose defensive plan involves all infantry weapons and supporting artillery fire. Therefore in determining the frontage which a large command can defend effectively, the rifle battalion becomes the unit of measure. A battalion organizing a front-line defense area can defend the following frontages:

(1) For defense of vital tactical locality with limited observation and fields of fire such as in heavily wooded terrain, not to exceed 800 yards.

(2) For defense of vital tactical locality on average terrain, not to exceed 1,500 yards.

*c.* A front-line battalion usually will locate two companies on the main line of resistance and one company in battalion reserve (see fig. 12).

(1) Companies on the main line of resistance organize company defense areas capable of mutual support.

(2) The function of the battalion reserve is to expel the enemy by fire and movement from any portion of the battalion area which may have been occupied by the enemy. Should the tactical situation prevent counterattack, the reserve must stop or delay further advance of the enemy and must accordingly be prepared for defense to the front, flanks, and rear.

d. A battalion defense area on the regimental reserve line ordinarily must cover the combined frontages of two battalion areas on the main line of resistance. A battalion in regimental reserve usually prepares positions for its companies abreast along the regimental reserve line; any organization in depth of the regimental reserve position must be accomplished by the companies in their dispositions of rifle platoons, light machine guns, and 60-mm mortars.

e. *Supporting weapons.*—A battalion plan is drawn up for use of all supporting weapons.

(1) *Heavy machine guns.*—(a) The heavy machine guns are disposed in width and depth throughout the battalion defense area. Their fire forms the framework with which all other fire directed against foot troops is coordinated, other weapons being used to fill in any gaps in such fire. They should be able to cover the front of the position with continuous interlocking bands of grazing fire, and to cover the most likely avenues of enemy approach with enfilading fire. Other weapons are used to fill in any gaps in fire of machine guns. The primary mission for each gun normally includes placing an extended band of grazing fire along the wire or other obstacle on the front or flank of a defensive area, such fire to be delivered under any conditions of visibility. The line along which this fire is delivered is called the *final protective line*.

(b) It is necessary to provide depth to machine-gun defense so that the guns will be in position both to prevent enemy penetration to the rear part of the position and to support counterattacks.

(c) Heavy machine guns are sited in pairs, the guns of each pair having identical sectors of fire. They are located

either within or under protection of platoon defense areas. Each gun should have primary and alternate emplacements from which their primary mission can be accomplished, and a supplementary emplacement from which a secondary mission can be accomplished. The guns in a pair should be spaced 20 to 50 yards apart, close enough for control by one man but far enough apart so that one shell burst cannot put both guns out of action. Primary and alternate emplacements should be at least 50 yards apart so that fire directed on one location will not through natural dispersion cover both. All emplacements should provide splinterproof shelter and should have covered routes of approach or approach trenches for supply and communication.

(2) *Mortars.*—The 81-mm mortars are assigned a position area within the battalion defense area far enough to the rear of the main line of resistance so that they can direct fire into platoon defense areas on that line without displacing to the rear. Within the position area each mortar is provided with primary and alternate emplacements so located that from them fire can be directed on any gaps in fire of the flat trajectory weapons. Each mortar requires an observation post and a covered route of approach. All emplacements should be the open standing type carefully concealed from air and ground observation. They should preferably be located in defiladed positions.

(3) *Antitank guns.*—The mission of the battalion anti-tank guns is to provide protection for the battalion sector from tank attacks. The guns should therefore be located so as to cover probable routes of approach for tanks. They should be far enough forward to engage a tank attack before it reaches the main line of resistance, but in any case should not be forward of the front line of platoon defense areas. The guns are distributed laterally rather than in depth, and where possible should be able to fire in support of each other. They should be provided with primary, alternate, and supplementary positions, all of the open standing type, well concealed. As the guns operate by direct observed fire only, all emplacements must be located and constructed to permit this.

*f.* A battalion defense area is organized for all around defense against both foot troops and tanks.

(1) Belts of obstacles surrounding the company defense areas are connected so as to form a continuous belt effective against foot troops around the battalion defense area located so that all points can be covered by fire. Particular attention must be paid to siting of obstacles so they can be enfiladed by fire of heavy machine guns. Wire entanglement placed primarily for this purpose is called *tactical* wire, as distinguished from wire entanglement used primarily to protect a platoon defense area from being rushed, which is called *protective* wire. Wherever possible, both functions should be performed by one belt of wire or other obstacle in order to conserve materials and labor.

(2) Tank obstacles should be provided to block all possible avenues of approach for tanks into the battalion defense area. Locations of tank obstacles and battalion antitank guns should be coordinated so that the guns can cover the obstacles by fire, if possible. Otherwise the antitank guns are located to cover the most favorable approaches for tanks not covered by obstacles.

*g.* Battalion command and observation posts are located in accordance with provisions enunciated for the company, the command post usually being in the battalion reserve area.

*h.* Company and platoon defense areas should be assigned sectors or positions which will most effectively protect the key point of the battalion defense area by covering routes of approach to the key point with planned fire. Development of the fire plan involves siting weapons and assignment of sectors and areas of fire so that all area in front of the position can be covered by some type of destructive fire, and that fire can be delivered against the enemy if and when he succeeds in penetrating any part of the position. It is essential to coordinate fire of subordinate units to avoid and eliminate duplication, to assure that all areas are covered, to see that fire gives mutual protection to adjacent units and weapons, to assure maximum development of flanking fires, and to see that fires are capable of being switched and shifted to meet unexpected developments.

■ 21. REGIMENTAL SECTORS.—*a.* A regimental sector is the largest defensive area in a battle position and is the only one which completely covers the battle position in depth. It normally consists of three battalion defense areas, of which two are on the main line of resistance and one on the regimental reserve line. They are disposed so as to occupy and defend keypoints

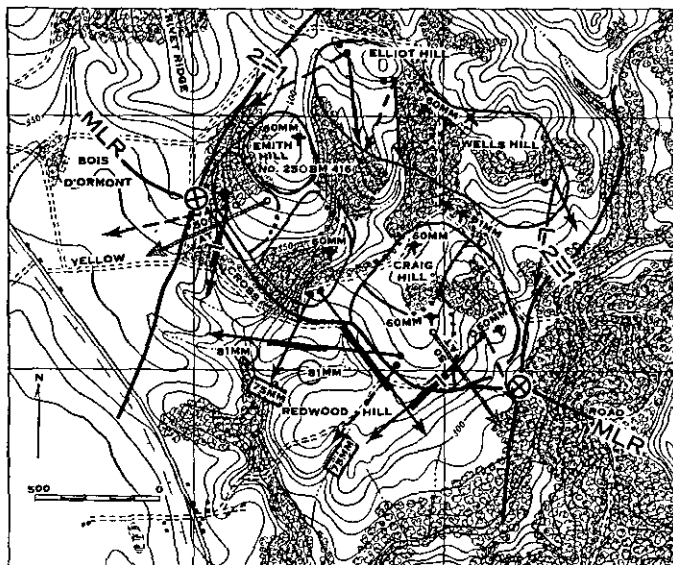

FIGURE 12.—Battalion defense area.

NOTE.—Locations and fires of all weapons of the battalion to include light machine guns of rifle companies and locations of their 60-mm mortars are shown. Primary target areas for the 81-mm mortars and normal barrages of supporting artillery are shown. Note that some of the 60-mm mortars are attached to front-line platoons and that the caliber .30 light machine guns are employed in the defense in the same manner as heavy cal. .30 machine guns.

within the regimental sector, and so as to protect keypoints in rear of the regimental sector, especially those affording observation to the supporting artillery. Their fire must be coordinated both within the regimental sector and with that of adjoining sectors.



*b. 37-mm antitank guns.*—(1) Antitank defense of a regimental sector consists of two coordinated echelons, the battalion antitank guns for defense of forward areas and the regimental 37-mm antitank guns to give depth to the defense and to protect the flanks. They should either be placed within or under protection of company defense areas or be assigned troops to furnish local protection.

(2) Due to its low mount, the antitank gun cannot be dug in at its firing position. When not in action the guns are usually held in positions of readiness near their firing positions in areas defiladed from flat trajectory fire, shelter or concealment being provided for gun and crew. Firing positions should be located on commanding ground with wide, clear sectors of fire covering probable routes of tank approach. They are not prepared except for providing fox holes for operating crew and digging in ammunition.

*c.* In organizing the regimental sector, no obstacles against foot troops are ordinarily provided beyond those included in the battalion defense area. However, additional antitank obstacles normally will be necessary. They usually will include the more readily constructed types such as mine fields and heavy abatis. Their location should be coordinated with fire of antitank guns and caliber .50 machine guns so that all such obstacles are covered by fire.

*d.* Antiaircraft protection within the regimental sector is limited to prescribing areas of air responsibility for the various subordinate units and assigning antiaircraft fire missions as primary missions to certain units or weapons, principally to heavy machine guns.

■ 22. ADDITIONAL ORGANIZATION.—The preceding paragraphs do not describe a complete organization of the ground; rather, they indicate the minimum that should be done for a rear position. The defensive strength of a position can be increased materially by connecting squad trenches, providing approach trenches, strengthening tank obstacles, providing shellproof weapon emplacements and protected shelters for personnel, and such other additional work as the situation demands or time and labor permit.

■ 23. ARTILLERY SUPPORT.—In addition to organic weapons, the infantry normally receives direct support from artillery

in the form of barrages and concentrations covering such areas and delivered at such times as the Infantry desires. Pertinent data on such fire are given in table II.

TABLE II.—*Placing of barrage fired by a battery of field artillery*

Caliber (mm)	Type	Burst of 1 shell	Area of barrage		Diameter of concentration	Minimum safe distance from infantry in—	
			Normal	Emergency		Open	Trenches
75	Gun.....	5 x 30	100 x 200	100 x 300	100-300	200-500	200-400
105	How.....	9 x 40	100 x 300	100 x 400	200-400	300-400	200-400
155	{ Gun..... How..... }	9 x 70	-----	-----	200-400	600-700	300-400

NOTE.—All dimensions given are in yards. Safe distances will vary with ranges and nature and efficiency of observation. In general, barrages should be placed at distances of 300-500 yards from infantry. If protection furnished is exceptionally good, minimum distances given may be reduced by about 50 yards.

■ 24. OUTPOST AREA.—*a.* The enemy situation permitting, every battle position should be covered by an outpost to the front. The area in front of the main line of resistance of the battle position occupied by the outpost is called the outpost area.

*b.* When the outpost troops have only the usual outpost missions, that is, to protect troops in rear against surprise, to prevent an attack upon them before they can be prepared to resist, and to prevent or restrict enemy reconnaissance and ground observation, little effective resistance to a general attack is expected. The outpost consists of squads, platoons, companies, or battalions, depending on depth of the outpost area, sent forward by units holding the battle position. Little ground organization is contemplated. An outpost line of resistance (OPLR) should be designated along which the outpost is disposed so as to carry out its mission. The fires of elements of the outpost and its supporting artillery are coordinated along this line.

c. When in addition to the above missions the outpost is charged with absorbing shock of an attack, depriving it of momentum and breaking up the enemy organization, battle ensues over a zone of considerable depth. The outpost area is organized as thoroughly as conditions will permit, and battle positions and organized outpost area collectively are called a defensive zone (see fig. 13).

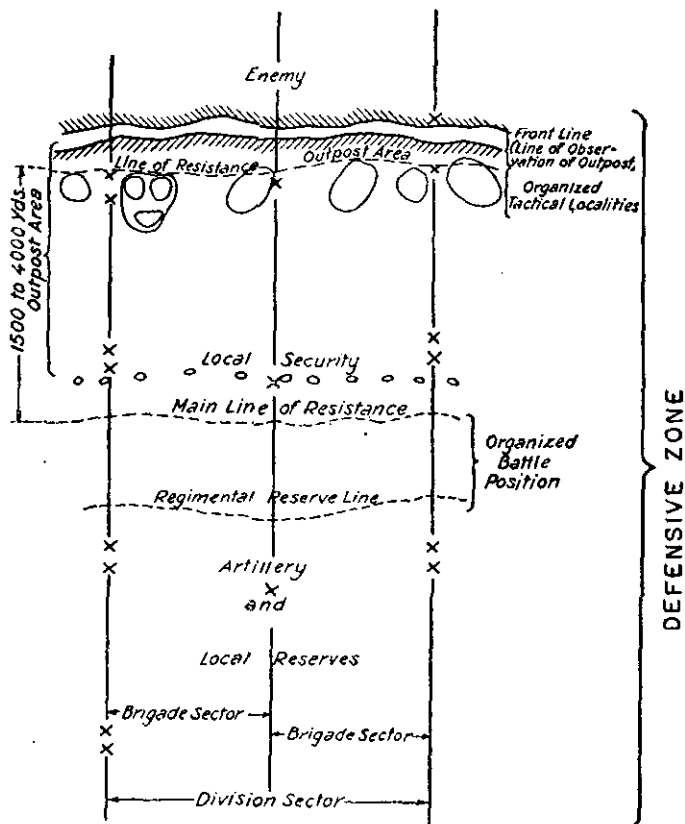

FIGURE 13.—Defensive zone (square division).

*d.* Organization of the outpost area is coordinated by designation of a line of resistance for the outpost which should be located not less than 1,500 nor more than 4,000 yards in front of the main line of resistance in order to give sufficient depth to the outpost area and in order that artillery located behind the battle position can support the outpost and place fire from 1,500 to 2,000 yards beyond the front line. A line of observation is established in front of the outpost line of resistance. Outpost forces generally consist of battalions or companies with attached machine guns sent forward by regiments or brigades holding sectors of the defensive zone. The organization consists of mutually supporting tactical localities similar to those heretofore described for the battle position. Units of the outpost usually are required to cover more extensive fronts than similar units on the battle position. This results in greater intervals between tactical localities. Companies may be required to cover 800 to 1,500 yards of front and a battalion 2,000 to 2,500 yards. The important tactical localities in an outpost area are those which furnish important observation into the enemy territory and control probable routes of enemy advance into the defensive system. These are organized usually as company defense areas or if their importance warrants as battalion defense areas. Intervals between these important localities should not exceed 3,000 yards. Where necessary, intervals between these defense areas are covered by the organization of detached platoon defense areas. Because of the longer time they can hold out and the greater effect of larger organizations in breaking up enemy attack formations, provision should be made in case of a general attack for withdrawal of garrisons of small organized localities into the larger and more important ones.

*e.* In some situations in zone defense the importance of the front held and quantity and power of enemy artillery require that the main line of resistance be placed far enough in rear of the OPLR to be beyond effective range of the bulk of the hostile guns, 6,000 to 8,000 yards. This depth of outpost area is too great to permit adequate support of the outpost from the battle position, and some troops (infantry and artillery) must then be located between the front line and the

battle position to support the forward outpost elements and supplement their action in delaying and disorganizing hostile attacks. Such an outpost area is in effect a delaying area (fig. 14).

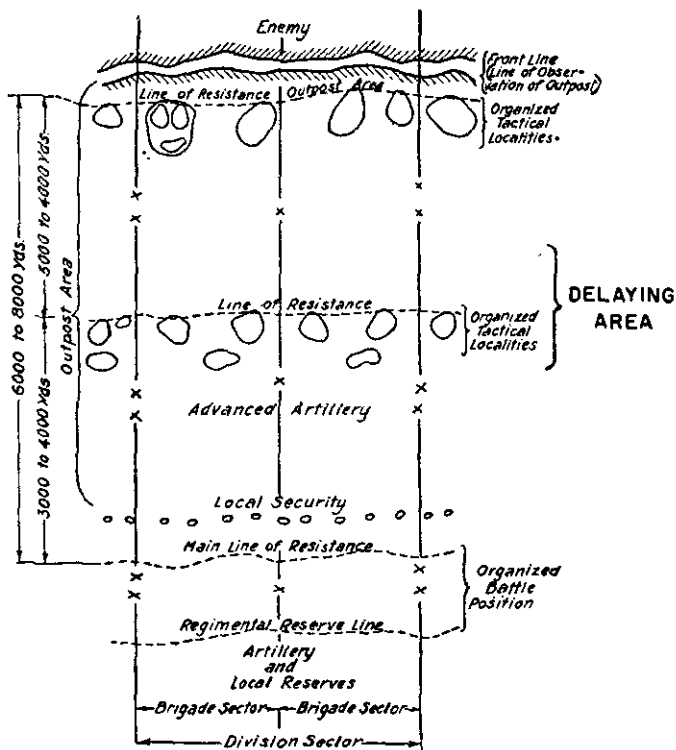

FIGURE 14.—Defensive zone with deep outpost area (square division).

f. Continued occupancy of a defensive zone results in development of organized tactical localities of the outpost area into a more or less well-organized position consisting of—

(1) A line of observation (the front line) in front of the line of resistance occupied by outguards to provide observation and defense of the foreground.

(2) A line of resistance occupied by company defense areas to cover the front by fire and to hold important tactical localities.

(3) A reserve area occupied by company defense areas to assist the units on the line of resistance (fig. 15).

■ 25. RESERVE BATTLE POSITION.—a. In any defensive situation the commander must always consider the possibility of

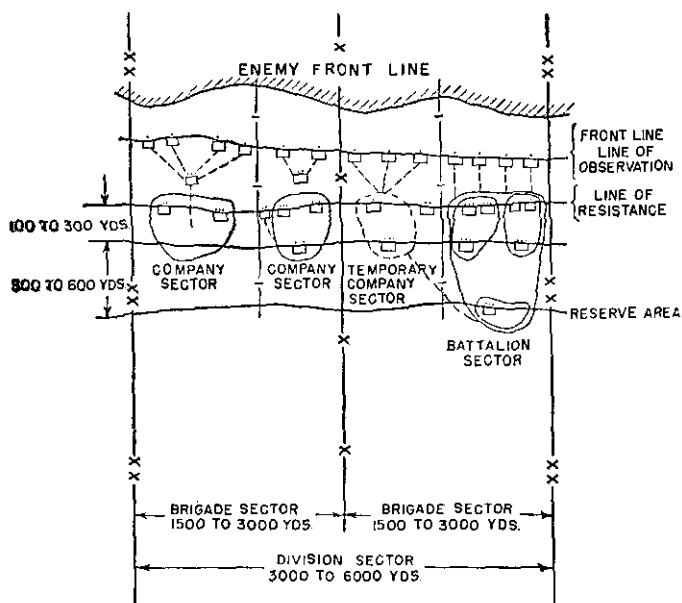

FIGURE 15.—Elements of an outpost position for a defensive zone (square division). (Distances shown are approximate.)

defeat in the selected battle position and the necessity of a continuation of the defense farther to the rear. Depending upon time available and importance of the front held, an additional battle position may be—

- (1) Selected from the map.
- (2) Reconnoitered and a plan of organization prepared.
- (3) Staked out and partly or wholly organized.

b. Such a position is designated as the "reserve battle position" (fig. 16). On highly important fronts additional positions in rear of the reserve battle position may be selected, reconnoitered, and staked out. Selection of the reserve battle position and other positions in rear is based on placing them at such a distance in rear of the battle position next in front that the enemy after having successfully attacked a forward position would have to advance the bulk of his artillery before undertaking attack of the next battle position. The requirement calls for a distance of at least 6,000 yards; configuration of the terrain may require some modification of this rule.

■ 26. SWITCH POSITIONS.—In addition to the several positions or organized areas of a defensive zone paralleling the front, additional positions are provided oblique to the front and connecting the forward position or areas with those in rear. These oblique positions, designated "switch positions" (fig. 16), are established on the flanks of localities in the defensive system where due to lack of natural defensive strength or for other reasons there is a probability of an enemy penetration. Attacks against a defensive zone in order to break through the defensive organization on a front broad enough to insure success must be exploited to the flanks as the advance progresses to counteract narrowing of the initial front of attack by resistance of the defense. Switch positions are planned to resist exploitation by the enemy to the flanks of a penetration, to insure continuity of the front when forward defenses have been broken through, and finally to provide a line from which general counterattacks against the flank of a penetration may be started.

#### SECTION IV

#### EFFECT OF PROJECTILES

■ 27. GENERAL.—Penetration and effect of small-arms, artillery projectiles, and aircraft bombs are extremely variable. Fortifications must therefore be designed with large safety factors. However, maximum probable penetration and effect must be kept in mind so that works may be strong enough to resist projectiles without unnecessary expenditure of labor and material.

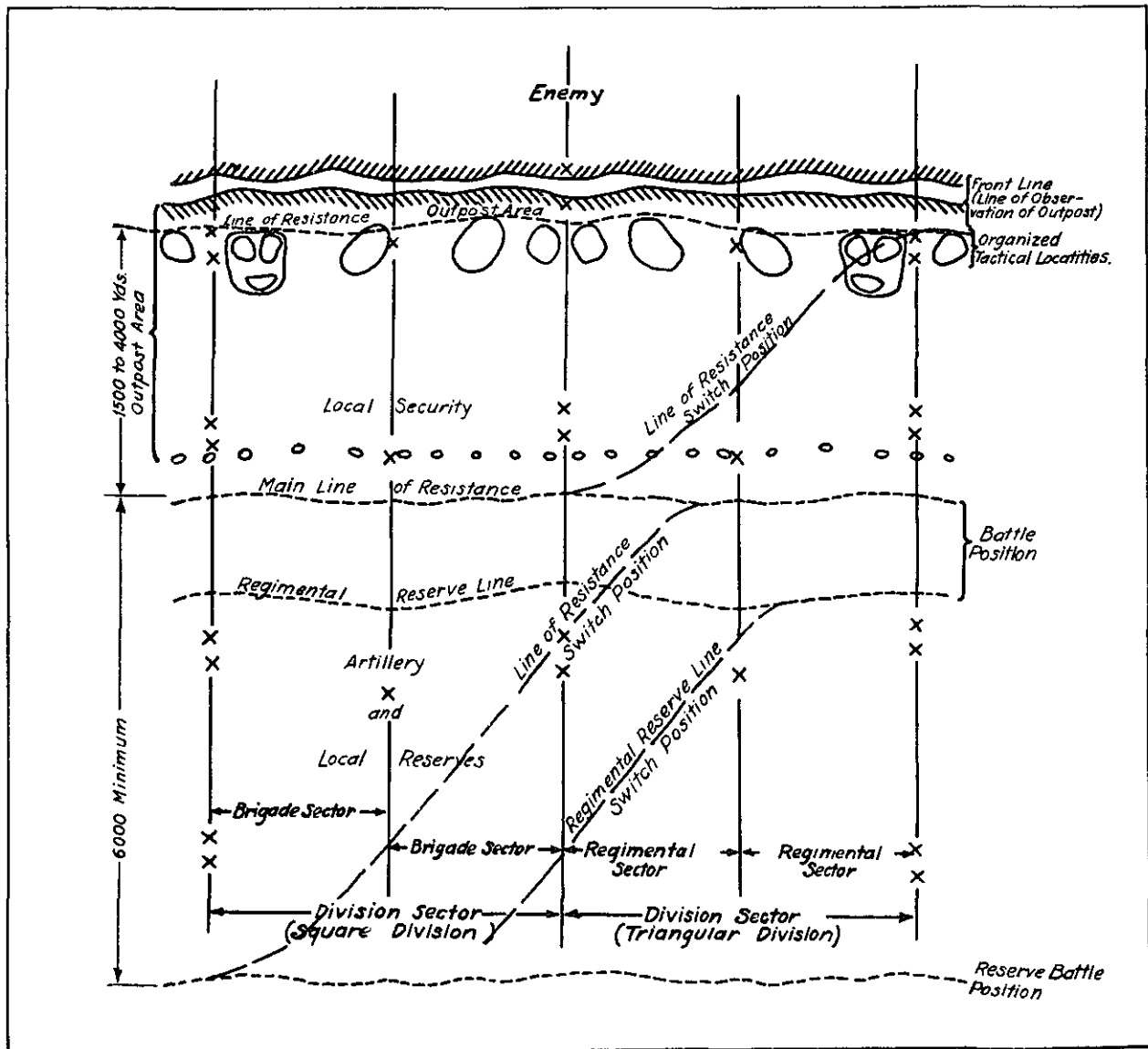

FIGURE 16.—Defensive system showing battle position, outpost area, reserve battle position, and switch positions (square division).



■ 28. INFANTRY WEAPONS.—*a. Penetration of cal. .30 rifle, automatic rifle, and machine-gun nonarmor-piercing bullets.*—(1) The United States Army rifle, M1903, the new M1 semi-automatic rifle, cal. .30 Browning automatic rifle, and the cal. .30 machine gun all fire the same ammunition and may be taken as a fair example of the small arms of the various nations. The 174-grain boat-tail bullet fired by these weapons has a flat trajectory and wide danger zone at all probable ranges.

(2) Table III below gives approximate maximum penetrations in various materials of the 174-grain nonarmor-piercing bullet fired from the rifle at range of about 200 yards, together with thickness of armor necessary to give adequate protection. Prolonged concentrated fire (for example, from a machine gun) will penetrate these thicknesses. Though this effect is not likely to occur often, it may be necessary in special cases to provide extra thickness for protection.

TABLE III.—*Safe thickness of material to protect against the 174-grain, nonarmor-piercing bullet*

Material	Maximum penetration	Thickness to be provided	Remarks
	<i>Inches</i>	<i>Inches</i>	
Armor plate.....	0.3	0.5	
Concrete (plain).....	2.0	3.0	
Brick masonry.....	5.0	7.0	Greater penetration when bullets strike in soft mortar.
Gravel.....	8.0	10.0	
Sand:			
Dry.....	12.0	14.0	
Moist.....	14.5	18.0	
Solid oak.....	20.0	24.0	
Earth loam.....	30.0	36	
Greasy clay.....	60.0	72	Varies greatly. This is maximum.

*b. Armor-piercing caliber .30 and caliber .50 bullets.*—

(1) Table IV below gives some of the characteristics of special armor-piercing caliber .30 and caliber .50 bullets.

TABLE IV

Caliber	Projectile weight	Armor penetration at—		Thickness of armor to provide protection
		100 yards	300 yards	
.30, M6.....	<i>Grains</i> 174	<i>Inches</i> 5/8	<i>Inches</i> -----	<i>Inches</i> 1
.50, M6.....	753	-----	1	2

(2) It may be taken as a general rule that specially designed armor-piercing rifle and machine-gun bullets at their most favorable ranges can penetrate special steel (tank) armor twice their caliber in thickness and that armor four times the caliber in thickness gives adequate protection against them.

*c. Special armor-piercing.*—(1) Table V gives characteristics of infantry weapons specially designed for their armor-piercing qualities. They are typical of such weapons likely to be found in the various modern foreign armies.

TABLE V

Antitank gun	Projectile weight	Muzzle velocity	Armor penetration	
			600 yards, normal impact	1,000 yards, 20° impact
	<i>Pounds</i>	<i>Feet per second</i>	<i>Inches</i>	<i>Inches</i>
25-mm.....	0.72	3,000	1.95	-----
37-mm.....	1.85	2,600	2.20	1.5
47-mm.....	3.50	2,000	1.90	-----

(2) Penetration of armor cannot be counted upon when the angle of impact is greater than 30° from normal. At these larger angles of impact the projectile either ricochets or breaks up.

*d. Mortar shell.*—Infantry mortar shell similar to the 60-mm and 81-mm mortars have a high angle of fall and can reach defiladed objects. Due to their low velocity they

have little penetrative power. On the other hand, they carry heavier bursting charges than artillery projectiles of corresponding weight and caliber. They are consequently especially effective when used against light obstacles, and produce serious destructive effects when they fall within trenches. They are effective against surface and light shelters but are relatively ineffective against shell-resisting or bomb-resisting structures.

■ 29. ARTILLERY AND AIRCRAFT.—*a. General.*—(1) This paragraph covers penetration and crater effect of projectiles in natural earth and their effect upon various types of fortifications. Effect of single artillery shells or bombs is stated with a view to establishing in the mind of the engineer a conception of what constitutes safe construction and the resistance to fire various type of fortifications will present.

(2) Penetration and crater effect of projectiles are highly variable. Fortifications intended to resist continued bombardment must be designed with very large safety factors. Probability of such continued bombardment and probable power and direction of projectiles likely to be used by the enemy must be fully considered.

*b. Shell or bomb.*—(1) If the projectile has an instantaneous fuse, the detonation of the filling and bursting of the case will occur so quickly that the projectile will not have time to penetrate the object it strikes to any great extent and depth of penetration will be indeterminate. If a fuse with sufficient delay is used and the angle of impact is not such as to produce a ricochet, the projectile will penetrate the object it strikes and detonate at a depth dependent on several factors, among which are nature of materials penetrated, terminal velocity of projectile, weight and cross section of projectile, strength of projectile case, and type of delay fuse used. Deep penetration in connection with long delay fuses where the projectile has attained its full penetration before it explodes serves to place the projectile where it is well tamped and the explosion probably does the most damage, that is, deep in parapets of trenches, inside casemates, and nearer chambers of underground shelters than the surface. Destructive effect is due to impact of the unexploded shell,

impact of the explosion, and shattering or disruptive effect of the explosion, including fragmentation and cratering.

(2) It is emphasized that these several factors which produce destructive effect of projectiles are defined only for general information purposes. Sufficient experimental data are not available to conclude that in any given case the various effects are cumulative or selective, and it is not possible to state against which effect or combination of effects protection must be provided. It is important to realize the limitations imposed both by inherent uncertainties of warfare and difficulties surrounding research.

*c. Ricochets.*—The course followed by a projectile after impact on level ground depends on angle of impact, terminal velocity, weight and dimensions of the projectile, its rotational motion (if any), and resistance of the ground. In general, action is as follows:

(1) If angle of impact is less than  $7^\circ$ , projectile ricochets.

(2) If angle of impact is between  $7^\circ$  and  $25^\circ$ , shell either ricochets after traveling a short distance in the ground, or remains in the ground at slight depth. Long pointed shells usually show a greater tendency to come out of the ground than short pointed ones.

(3) If angle of impact is between  $25^\circ$  and  $40^\circ$ , projectile has a tendency to turn toward the surface and deep penetrations are not generally secured.

(4) If angle of impact is greater than  $40^\circ$ , projectile follows a straight course and reaches maximum depth consistent with its terminal velocity, weight, form, and hardness of the ground. This is the class of fire against which protected shelters must be designed, and is in general characteristic of aircraft bombs on horizontal surfaces.

*d. Penetrations.*—(1) *Formula.*—Experimental data with respect to penetration are inadequate. The following empirical formula has been developed to give maximum penetration of projectiles in various materials, impact being normal. It applies both to artillery and aircraft projectiles.

Results given by the formula will be considered only as approximations.

$$P = \frac{0.23 W A K}{D^2}$$

in which **P**=Penetration of projectile in feet.

**W**=Weight of projectile in pounds.

**D**=Diameter of projectile in inches.

**A**=A constant depending on striking velocity according to the following table:

Velocity, feet per second	A	Velocity, feet per second	A	Velocity, feet per second	A
130.....	0.33	657.....	4.77	1,180.....	8.76
197.....	0.72	720.....	5.34	1,250.....	9.15
262.....	1.21	788.....	5.89	1,320.....	9.54
328.....	1.76	854.....	6.41	1,375.....	9.92
394.....	2.36	920.....	6.92	1,445.....	10.29
460.....	2.97	985.....	7.40	1,510.....	10.64
525.....	3.58	1,050.....	7.87	1,575.....	10.98
592.....	4.17	1,113.....	8.31	1,640.....	11.20

**K**=A constant depending upon nature of resistance shown in the following table:

Material	K	Material	K
Concrete masonry.....	0.64	Sandy earth.....	2.94
Stone.....	0.94	Ploughed earth.....	3.86
Brickwork.....	1.63	Clay soil.....	5.87

**W** and **D** are obtained from characteristic tables of the projectile under consideration.

(2) *Field artillery projectiles.*—The following table gives penetration of field artillery projectiles in ordinary compact soil:

TABLE VI.—Penetration of field artillery projectiles

Caliber	Striking velocity	Angle of impact	Penetration	
			Vertical	Horizontal
	<i>Feet per second</i>	<i>Degrees</i>	<i>Feet</i>	<i>Feet</i>
75-mm.....	730	45	4	4
105-mm.....	800	45	5	5
155-mm.....	770	45	7	7
8-inch.....	790	45	9	9
240-mm.....	806	45	14	14

(a) Figures 17 and 18 give data secured by firing sand-loaded shell, observing point of fall, and then digging up the shell. These illustrations, together with the more extensive experiments upon which they are based, indicate that when angle of impact is greater than  $40^\circ$  the projectile moves in a straight line until a considerable proportion of its velocity is lost. Then, particularly if it meets a somewhat harder stratum of material, it tumbles forward and comes to rest with its nose to the rear.

(b) To secure deep penetrations, large caliber howitzer projectiles which strike the target with an angle of impact in excess of  $40^\circ$  are required. Weapons smaller than the 155-mm howitzers and flat trajectory weapons are in general ineffective against heavy fortifications. Large howitzers or mortars are required to destroy well-constructed cut-and-cover and cave shelters.

(c) For thickness of cover required to provide protection against various artillery projectiles see table XXVI, paragraph 53.

(3) *Airplane bombs.*—(a) *Data.*—Experimental data pertaining to the penetrations of airplane bombs in earth are inadequate.

(b) *Striking velocity.*—The trajectory of a bomb is a curve which would be a parabola in vacuo but in air is somewhat steeper. The bomb loses speed in its initial direction but gravity gives it velocity toward the earth which increases to a certain maximum limited by air resistance. Maximum

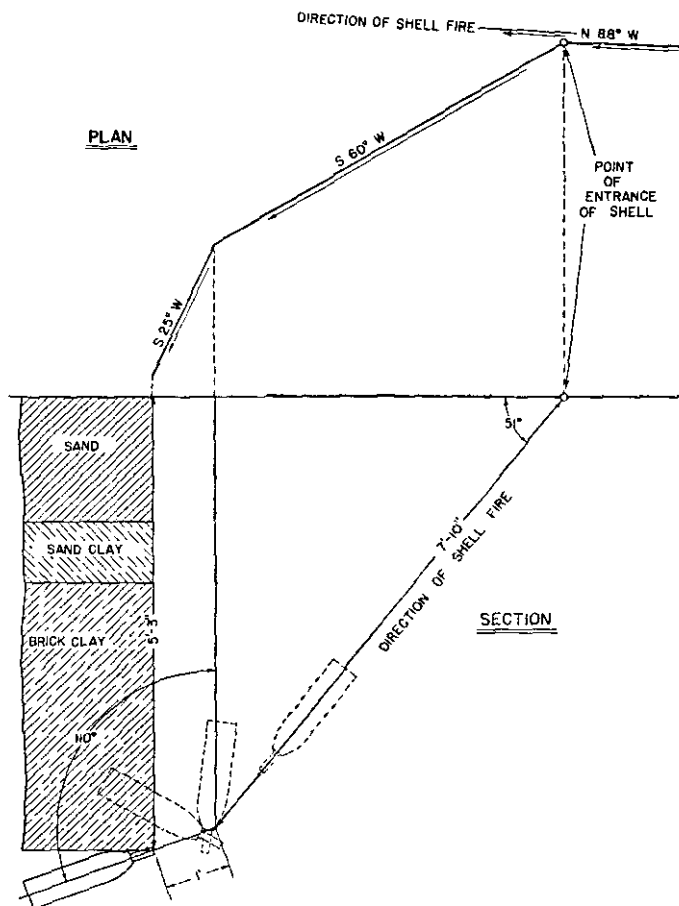

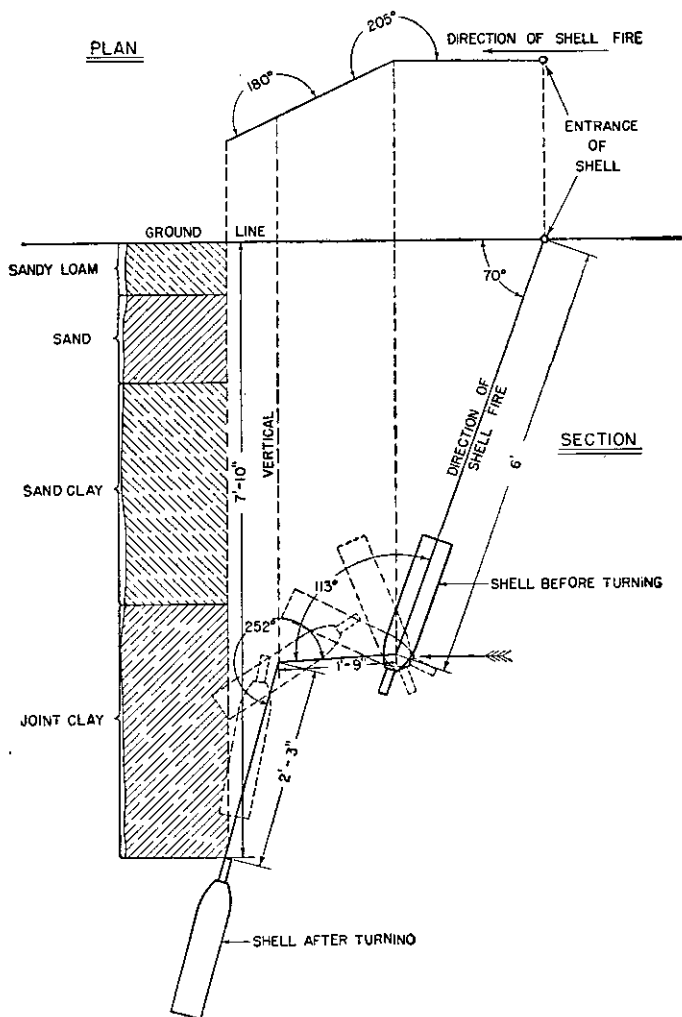

FIGURE 18.—Penetration of 155-mm shell.



striking velocity depends on weight, shape, and dimensions of the bomb, and prevailing atmospheric conditions. From the point of view of structural protection, angle of impact, that is, the angle which the bomb makes with the vertical at the moment of impact, is important. Table VII gives approximate striking velocity and angle of impact for bombs heavier than 100 pounds released from an aircraft flying horizontally at 200 miles an hour.

TABLE VII

Height of release	Angle of impact with vertical	Striking velocity
<i>Feet</i>	<i>Degrees</i>	<i>Feet per second</i>
1,000	46	390
3,000	33	520
5,000	26	610
7,500	22	710
10,000	19	800
12,500	17.5	880
15,000	16	950

Taking all factors into consideration, it is safe to assume that the maximum striking velocity of a high-explosive bomb that need be taken into account in structural defense is 1,000 feet per second. The corresponding velocity for a 2-pound incendiary bomb is about 400 feet per second.

(c) *Types and dimensions.*—For convenience types of HE bombs are classified with reference to weight of the container as heavy-case, medium-case, light-case, and antipersonnel, as noted in table VIII.

TABLE VIII

Type of bomb	Charge ÷ weight percentage	Gross weight (pounds)
Heavy-case.....	Small.....	250 to 2,000.
Medium-case.....	25 to 40.....	50 to 1,000.
Light-case.....	50 to 60.....	50 to 2,000.
Antipersonnel.....	15 to 20.....	20.

Table IX gives typical dimensions for a few bombs. The figures in brackets in the second column give the length of bomb-carcass, that is, the part enclosing the charge. The tail portion is often only a stream lining designed to give good ballistics and to carry the fins.

TABLE IX.—*Typical dimensions of aircraft bombs*

Bomb	Length	Diameter	Sectional pressure <sup>1</sup>
	<i>Feet</i>	<i>Inches</i>	<i>Pounds per square inch</i>
2,000-pound, light-case.....	14 (9)	24	4.4
1,100-pound, heavy-case.....	6 (4)	12	9.7
550-pound, medium-case.....	5 (4)	15	3.1
220-pound, medium-case.....	4½ (2)	10	2.8
100-pound, medium case.....	4 (2)	9	1.6
20-pound, antipersonnel.....	2 (1)	5	1.0

<sup>1</sup> Weight ÷ maximum cross section area.

(d) *Depth*.—Figure 19 gives approximate depth of penetration at zero angle of impact, for unit sectional density of aircraft bombs. To obtain total penetration multiply value for penetration taken from the figure, by sectional pressure given in table IX. The formula in paragraph 29d conforms in general to the curves in figure 19.

(e) Referring to the formula given in paragraph 29d, the following computations are made:

550-pound bomb, D=15 inches (from table IX).

W=550 pounds (approximate).

Assume sandy earth, K=2.94; conditions giving 1,000 feet per second velocity of impact, then let A=7.50.

$$P = \frac{.23WAK}{D^2} = \frac{.23 \times 550 \times 7.50 \times 2.94}{15^2} = 12.4 \text{ feet.}$$

These results can only be accepted as approximations of penetrations to be expected in a sandy soil.

(f) Lighter bombs have little penetrative power, even in natural earth. Larger bombs have sufficient penetrative power to attack successfully protected shelters and buildings,

APPROXIMATE DEPTH OF PENETRATION  
FOR UNIT SECTIONAL PRESSURE OF BOMB

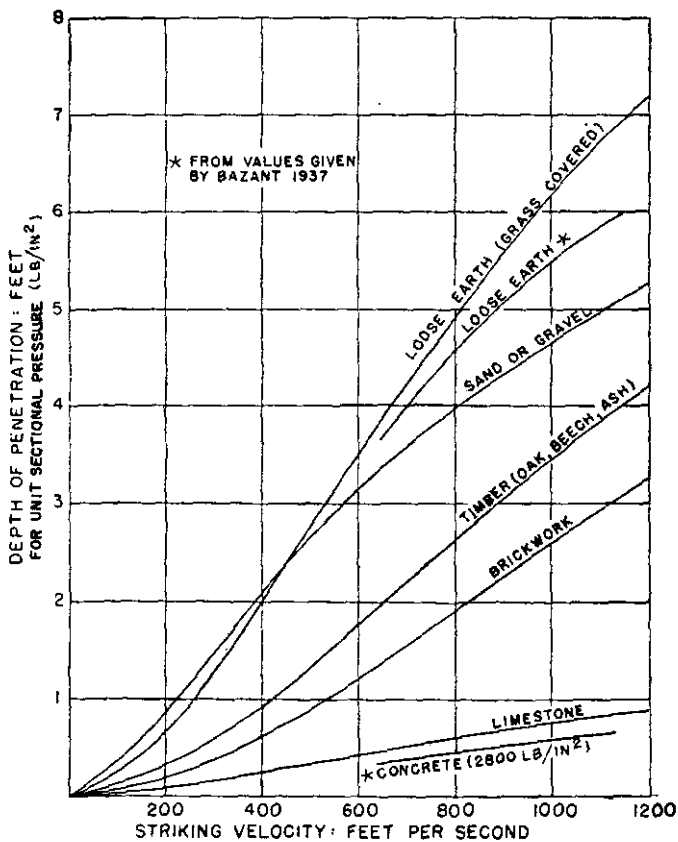

FIGURE 19.—Penetration of aircraft bombs.

TABLE X.—Penetration of high-explosive bombs, and from foreign

Bombs				Depth of penetration										
Weight 1	Caliber 2	Sectional pressure 3	Weight of filling 4	Earth 5	Clay with stones 6	Sandy soil 7	Firm gravel 8	Brickwork, soft rock 9	Hard limestone 10	Slab supported over whole of its surface				
										Mass concrete 11	Reinforced concrete 12	Mass concrete and reinforced concrete 13	Specially reinforced concrete 14	
Lbs.	In.	Lb/in <sup>2</sup>	Lb.	Feet	Feet	Feet	Feet	Feet	Feet	Feet	$u = 2,200$ Lb/in <sup>2</sup>	$u = 3,200$ Lb/in <sup>2</sup>	Feet	$u = 5,700$ Lb/in <sup>2</sup>
110	7.1	2.78	57	13.8	11.5	8.6	5.6	4.6	1.3	2.0	1.3	1.2	0.8	
220	9.8	2.92	120	14.4	12.5	9.3	6.3	5.0	1.3	2.0	1.3	1.3	1.0	
660	14.2	4.20	360	20.7	19.8	14.2	9.5	7.5	2.0	3.0	2.0	1.8	1.5	
2,200	21.6	6.00	1,200	29.5	-----	-----	-----	-----	-----	-----	-----	2.6	-----	
4,000	25.6	7.80	2,200	38.0	-----	-----	-----	-----	-----	-----	-----	3.3	-----	

## NOTES

All figures are feet and tenths of feet, except where shown otherwise.

Figures in columns 5, 13, and 15-19 are applicable to an average striking velocity of 820 feet per second.

and the largest bombs may even penetrate heavy concrete and armored structures.

(g) Table X gives penetrations of bombs of various sizes in earth, gravel, concrete, etc., as well as thicknesses required to be proof against them. These data are compiled chiefly from foreign sources and are, in general, based on theoretical analysis, since there is very little experimental information on the subject.

e. Crater dimensions.—(1) Light artillery projectiles make relatively small and ineffective craters for destruction of

*proof thickness to perforation and explosion, compiled sources*

Thickness just perforated by penetration without explosion			Thickness just perforated, explosion only		Proof thickness penetration and explosion					
Mass concrete	Reinforced concrete	Mild steel	Mass concrete	Reinforced concrete	Sandy soil	Firm gravel	Soft rock	Mass concrete	Reinforced concrete	Specially reinforced concrete
15	16	17	18	19	20	21	22	23	24	25
$u=2,800$ Lb/in <sup>2</sup>	$u=2,800$ Lb/in <sup>2</sup>	Feet	Feet	Feet	Feet	Feet	Feet	$u=2,200$ Lb/in <sup>2</sup>	$u=3,200$ Lb/in <sup>2</sup>	$u=5,700$ Lb/in <sup>2</sup>
2.8	1.8	0.3	2.0	1.5	19.5	18.0	11.5	5.5	4.3	2.8
2.6	2.3	0.4	2.5	1.8	26.5	24.6	16.5	7.4	5.6	3.7
5.1	3.3	0.6	3.6	2.6	39.0	36.0	24.6	9.0	7.0	4.6
7.5	5.1	0.8	5.4	4.1	60.0	-----	-----	12.0	-----	6.6
11.5	6.3	1.0	6.6	4.9	-----	-----	-----	-----	-----	-----

Columns 18 and 19 apply to thickness of slab just "perforable" by explosion of a bomb placed on the slab.

$u$  = Minimum crushing strength of concrete, at age of 28 days, in pounds per square inch.

trenches and shelters. These projectiles are effective however against exposed personnel and light obstacles designed to stop foot troops.

(2) *Medium and heavy artillery projectiles* are used for destruction of shelters, trenches, and other types of fortifications. Table XI below gives some idea of their relative effectiveness but it must be borne in mind that craters vary greatly with nature of the soil and depth to which the shell penetrated before explosion. This penetration is dependent upon both kind and setting of fuse and also upon the soil. Tabular dimensions must be considered as average.

TABLE XI.—*Probable size of craters in ordinary compact virgin soil*

(Light loam may double, loose soil triple these values)

Caliber	Slight penetration		Medium penetration	
	Diameter	Depth	Diameter	Depth
	<i>Feet</i>	<i>Feet</i>	<i>Feet</i>	<i>Feet</i>
75-mm.....	4	1.5	5	3
105-mm.....	6.5	2.5	7.5	3.75
155-mm.....	10	4	12	5
8-inch.....	11.5	4	13.5	5
240-mm.....	14	4	15.5	5.5

(3) Table XII gives average crater dimensions for *aircraft bombs* with instantaneous and delay-action fuses falling on sandy loam.

TABLE XII.—*Crater dimensions, sandy loam*

Bomb	Depth of crater	Diameter at surface	Earth displaced
	<i>Feet</i>	<i>Feet</i>	<i>Cubic yards</i>
<i>With instantaneous fuse:</i>			
100-pound.....	2	9	4
300-pound.....	3	13	10
600-pound.....	5	17	17
1,100-pound.....	6	20	23
2,000-pound.....	7	22	47
<i>With delay-action fuse:</i>			
100-pound.....	5	20	30
300-pound.....	7	27	70
600-pound.....	10	37	170
1,100-pound.....	13	45	320
2,000-pound.....	17	50	600

*f. Trenches.*—Artillery fire upon trenches can overthrow parapets and interior slopes, obstruct loopholes, and displace earth to the extent that the trenches are filled up or obstructed. Only direct hits by light artillery shells, 75-mm to 105-mm, produce appreciable results and fire of these guns is effective only when single hits can be observed, or when

the trenches are crowded with troops. Calibers of 155-mm and greater are normally required for destruction of trenches; 155-mm or 6-inch howitzers usually available in large numbers are the most important weapons used for such purposes.

*g. Shelters.*—(1) By use of protected shelters, it is possible to maintain the physical condition and morale of troops held near their combat positions. Modern artillery fire, especially that of howitzers which can destroy troops in open trenches, makes protected shelters an essential and possibly the most important element in a stabilized fortified battle position.

(2) Projectiles fired against protected shelters cause the most damage when they have penetrated deeply and explode either against or near the structure itself, the overlying material serving as a tamping so that the full force of the explosion is expended upon the shelter. Conversely, if deep penetrations are not secured and the projectile explodes nearer the ground surface than the shelter, this tamping effect is decreased and the force of the explosion escapes upward. Damage to the shelter is thereby greatly reduced. Howitzers and mortars are very effective weapons for attack of shelters as their fire produces few ricochets and nearly vertical impact with deep penetration.

*h. Obstacles and entanglements.*—(1) Light and medium artillery and trench mortars are sometimes employed to cut gaps in wire entanglements. The object would be to adjust a beaten zone of fire upon the entanglement so that enough shells will actually fall within its limits to effect destruction at the point desired.

(2) Requirements in rounds of 75-mm caliber to open a gap about 25 yards in width and 30 yards deep are approximately as follows:

Range, yards	Number of rounds	Range, yards	Number of rounds
2,500.....	600	5,000.....	1,000
3,000.....	700	7,000.....	1,200
4,000.....	800		

These requirements apply only to bands of wire not greater than 30 yards in depth located on practically level ground. Expenditure of such great amounts of ammunition on such a relatively nonremunerative target would rarely be justified. More ammunition must be expended to destroy deeper entanglements. Forward slopes increase and reverse slopes decrease accuracy of fire and respectively decrease and increase ammunition requirements. In particular, reverse slopes serve to make cutting entanglements by gunfire a difficult and expensive operation.

(3) Successive bands of wire should be sufficiently separated so that artillery fire must be adjusted on each band. A series of separate bands are much more difficult for artillery to cut than the same amount of material in a single band.

(4) Artillery firing upon entanglements uses high-explosive shell with instantaneous fuses except when the angle of fall results in ricochets. Then short delay fuses are used to secure bursts as the projectiles rise.

(5) Types of obstacles other than wire entanglements are attacked by artillery in the same manner but in general do not resist fire as well. Antitank obstacles however require tremendous expenditures of artillery ammunition for effective destruction and except in the case of fire against mine fields on hard ground, such fire may leave the ground as difficult for tanks to traverse as before.

*i. Concrete.*—(1) Existing information on resistance of concrete to shell fire has been assembled from observations made during the World War and from experiments in the case of heavy, permanent fortifications and primarily from wartime observations alone in the case of field fortifications.

(2) When large shells are exploded against concrete fortifications without penetration, severe vibrations are set up in the structure. At times these vibrations cause a separation of the steel and concrete in the case of reinforced structures which lowers resistance to subsequent shots. The heavy explosions coupled with the severe vibrations have a very appreciable destructive effect on morale of fortification garrisons.

(3) Large caliber weapons firing base-fused projectiles with solid heads and thick walls are required for destruction of



concrete works. Against horizontal slabs or those sloping very little from the horizontal, high angle fire must be employed.

(4) Concrete splinters badly under shell fire. Steps must be taken to protect the troops occupying concrete works from flying fragments of concrete.

(5) Concrete fortifications protected by sand or earth are much more effective than those without such protective covering. A layer of earth or sand tends to cause shells striking at an angle of less than  $40^\circ$  to begin to turn toward the surface or to ricochet and hence reduces the angle of impact with the concrete. The covering must first be blown off by shell fire before the concrete itself becomes vulnerable. When a bomb or shell with a delay-action fuse is used however, there is danger that the earth cover will help to confine or tamp the explosion and increase its effect. A concrete burster course or detonating slab is valuable for this reason, since its function is to detonate an instantaneous projectile or to prevent penetration of a projectile with a delay-action fuse. Walls which are perpendicular or nearly so are usually more easily destroyed by artillery fire than horizontal slabs. Not only is it easier to secure angles of impact approaching  $90^\circ$  against such walls, but the sand, earth, and debris in front of them fall away quickly and expose the bare concrete.

(6) On the whole, concrete, either plain or reinforced, may be considered as a most effective shell-resisting material. It is highly valuable for field fortifications whenever difficulties in connection with its use can be overcome. It is particularly useful for machine-gun emplacements, observation posts, shelters for machine-gun and other personnel that fire from open emplacements, in burster courses made up of many small, easily handled slabs, and for shelters that must be built above ground because of ground water or hard rock near the surface. See FM 5-10 for details of mixing and placing concrete in the field.

*j. Masonry.*—Stone and brick masonry show many characteristics similar to those of plain concrete but usually have much less power of resistance. The quality and strength of the mortar, interlocking bond used in laying courses, size and nature of stone or brick, all have a great deal to do with the resistance of masonry.

*k. Armor plate.*—Armor has been used extensively heretofore only in permanent fortifications. Steel turrets have been found to resist even the most intense artillery bombardment very well. Due to their small size it is difficult to secure direct hits on them. If they are properly designed even direct hits by heavy shell frequently ricochet without doing serious damage. Penetration is not essential to disable a turret however since it may become jammed by a direct hit or the supporting concrete so cracked or displaced that it cannot function.

*l. Buildings and villages.*—(1) Light and medium artillery and small aircraft bombs are used against wooden buildings. White phosphorus smoke shell, incendiary bombs, and low-bursting shrapnel are effective in starting fires.

(2) Medium and heavy artillery and medium aircraft bombs are used against stone and brick buildings. The cellars of masonry buildings are difficult to reach with artillery fire and frequently serve as effective shelters. The possibility of being trapped or buried by debris may make such locations dangerous.

## SECTION V

### TRENCHES

■ 30. GENERAL.—*a.* Trench construction may be considered under three heads, planning, tracing, and execution.

*b.* No work except that of the greatest urgency, notably that in connection with hasty defenses, should be undertaken without careful planning. Even when some delay results from this procedure, the time lost is usually regained in execution of the project.

*c.* It may be enunciated as a general rule that no work should be done at night that can be performed by day.

■ 31. TRACE, TRACING, AND PROFILE.—*a.* The detailed location of a trench on the ground or on a map is called its trace, and the operation of laying out this location on the ground with suitable marking devices is called tracing.

*b.* A profile is the cross section of the trench upon a vertical plane perpendicular to its direction. In order that discussions following may be clear, figure 20 shows nomenclature of various trench features.

■ 32. NECESSITY FOR STANDARD TYPES.—Trenches constructed in contact with the enemy are usually the result of hasty and frequently poorly coordinated efforts to obtain cover from enemy fire. Such trenches except in the most mobile situations must be developed into more complete and well-coordinated defensive systems. Both in this development and in construction of deliberate defenses out of contact with the enemy, a ready knowledge of certain standard trench traces and profiles assists materially. Established standards, workable and well-known with standardized material provided, give an objective toward which to work, though this ideal in many cases may never be reached. Experience teaches that practice may be restricted to a limited number of simple forms

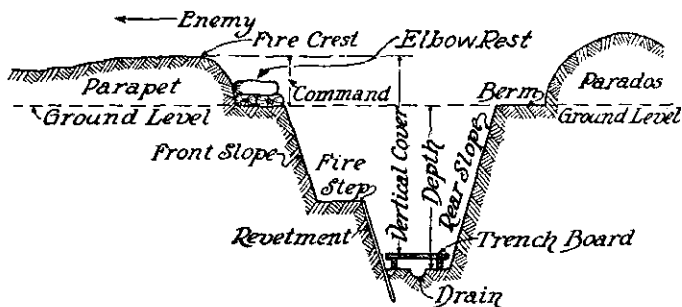

FIGURE 20.—Trench nomenclature.

that will meet practically all situations. Standardization of types and materials and familiarity therewith by all combat personnel in such detail as their duties require result in uniformity in training and practice, and economy in planning, execution, and supply of tools and materials.

■ 33. CLASSIFICATION.—*a. Direction* (fig. 21).—With reference to *direction*, trenches are classified as—

(1) *Parallel*, or those with general direction parallel to the front, primarily for fire purposes but also providing for lateral communication.

(2) *Approach*, or those with general direction perpendicular to the front, for fire or communication purposes or for both, depending upon location and use in the defensive system.

(3) *Switch*, or those with general direction inclined to the front; these connect two parallels for the purpose of preserving continuity of the front in case of capture of a portion of the line. Switch trenches are primarily fire trenches but may also serve as communication trenches.

b. *Employment*.—With reference to employment, trenches are classified as—

(1) *Fire*, designed primarily to provide cover for personnel when delivering rifle fire.

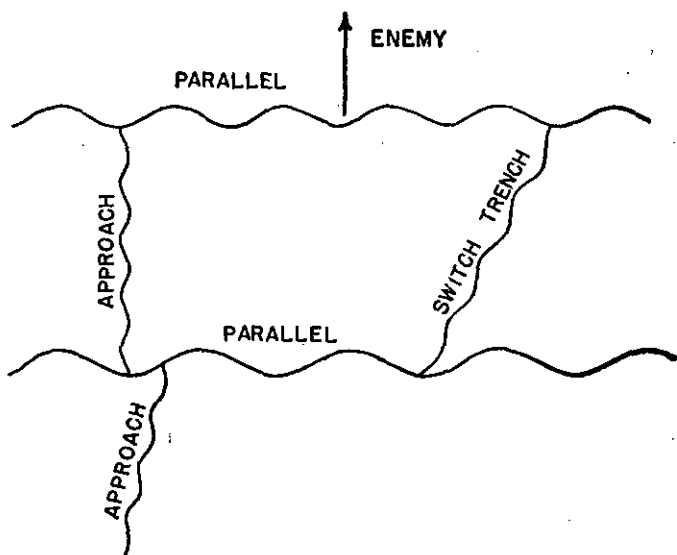

FIGURE 21.—Trenches classified by direction.

(2) *Communication*, designed primarily to provide cover for personnel moving from one part of an intrenched zone to another.

c. *Construction*.—With reference to construction, trenches are classified as hasty and deliberate. (See sec. I.)

(1) The principal works employed in connection with hasty defenses are hasty fox holes, trenches, and emplacements for automatic weapons and light mortars constructed on the

battlefield during mobile situations and usually under enemy fire.

(2) Deliberate trenches, constructed in connection with deliberate defenses, are those not included in hasty trenches on the one hand, and not pertaining to permanent fortifications on the other. Such trenches are usually more carefully designed than hasty types, are of stronger profile, and have greater defensive power.

*d. Sap.*—A sap is a trench which is constantly prolonged in the desired direction by digging away the earth at its head from within the trench itself. The earth is usually thrown up as a parapet on the exposed flank and end, thereby giving additional protection to the working party. Construction of saps is referred to as sapping.

■ 34. HASTY.—*a. General.*—The normal inclination of the soldier pinned to the ground by enemy fire is to “dig in” to hold the ground he has gained. The result of his efforts is a hasty intrenchment or fox hole which he constructs with the intrenching tools carried on the infantry pack. The hasty trenches discussed and illustrated in this section are given as examples of good practice rather than as standards to be followed rigidly. They represent excavations to gain hasty cover and to be developed eventually into forms approximating deliberate trenches.

*b. Skirmisher.*—Figure 22 shows the simple lying-down or skirmisher trench dug by the soldier while under small-arms fire. It is ordinarily excavated from the prone position by single soldiers or by small groups working side by side. In soft ground the soldier can mask himself from view from the front and secure appreciable protection from rifle and machine-gun fire in from 10 to 12 minutes. The trench should be completed to the dimensions shown in less than 1 hour when dug from a prone position with the infantry intrenching tools. It gives excellent protection against rifle and machine-gun fire, and to some extent against high-explosive shells. It is too shallow to protect satisfactorily from shrapnel fire. Additional protection may be gained by placing the pack, if carried, on the parapet.

*c. Fox hole.*—A more usual form of hasty intrenchment is the fox hole shown in figure 23. It is started from a prone

or crouching position ① and may be developed successively to kneeling ② and standing ③, which gives satisfactory protection against small-arms and light artillery fire. If engineer tools are used, not under harassing fire and in medium soil, the standing type can be completed by one man in slightly less than 1 hour. If infantry intrenching tools are used, the time to complete the standing type in medium soil is about 1½ hours. If under harassing fire, time required for completion will be increased, amount of increase depending on degree of enemy interference.

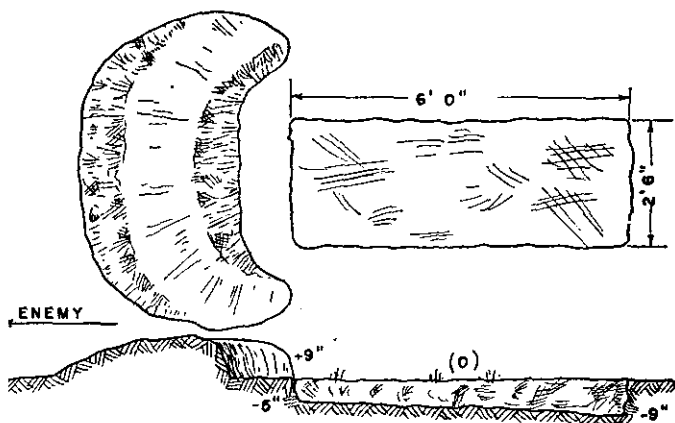
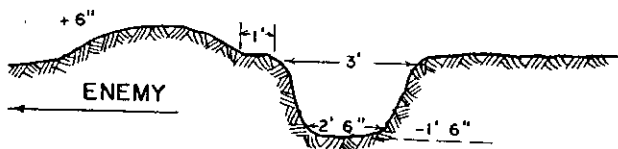

FIGURE 22.—Skirmisher trench.

*d. Shell hole positions.*—Hasty intrenchment may take the form of an improved shell hole shown in figure 24. In this case the improvement consists of a recess hollowed in the forward slope to give an inconspicuous but effective firing position with lateral protection from shell fragments and enfilade fire. In a shell-pitted area, shell holes afford quick protection and a high degree of concealment for a small expenditure of labor.

*e. Slit trenches.*—Narrow trenches are used during mobile situations for communication purposes and particularly for immediate protection of personnel from artillery fire. Figure



① Prone or crouching.

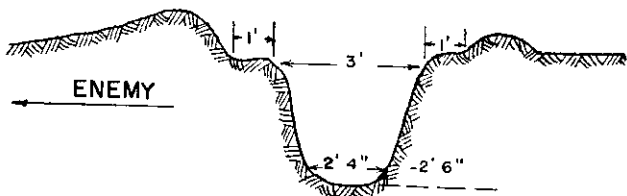

② Kneeling.

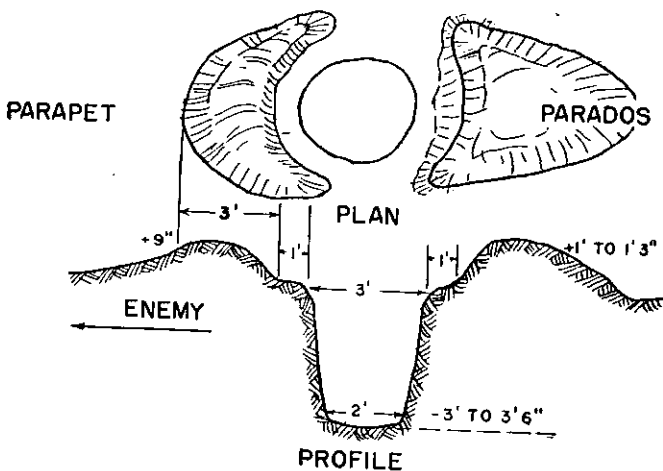

③ Standing.

FIGURE 23.—Fox holes.

25 shows creeping ① and standing ② types. Figure 26 shows a deeper trench revetted with struts resting against opposite walls and especially designed to protect against shell fire. Such a trench would be constructed only in short lengths adjacent to the firing position; it is particularly applicable for use as a shelter for machine-gun personnel. When spoil

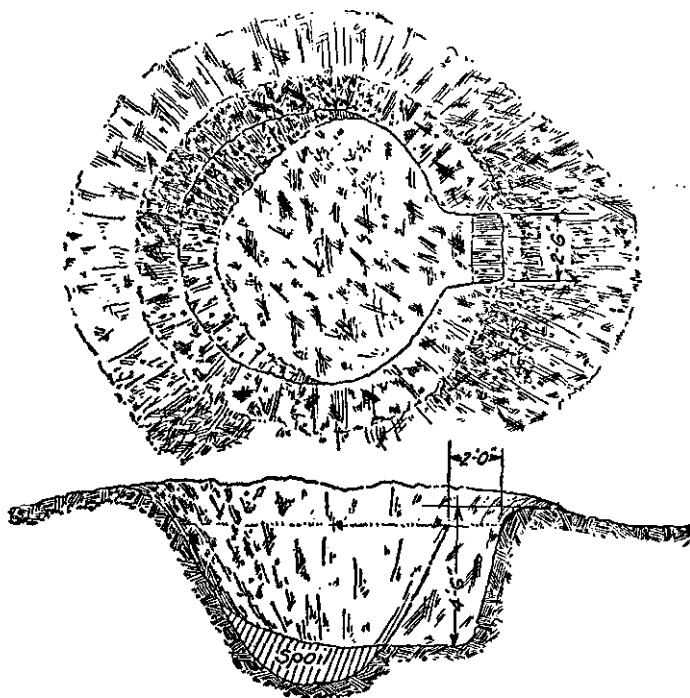
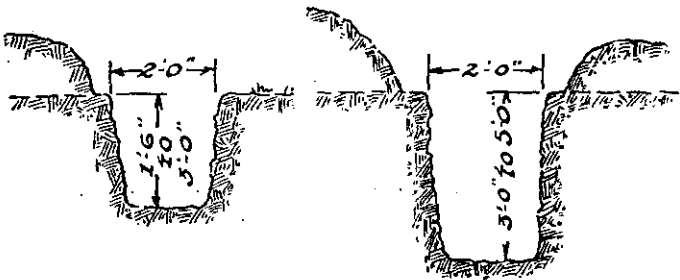

FIGURE 24.—Improved shell hole.

from slit trenches is wasted at a distance from the excavation, the trenches become nearly invisible to ground observation. Slit trenches are liable to be caved in by concentrated artillery fire thus becoming blocked as lines of communication, and deeper types are more dangerous to their occupants than trenches of wider profile.





① Creeping.

② Standing.

FIGURE 25.—Slit trenches.

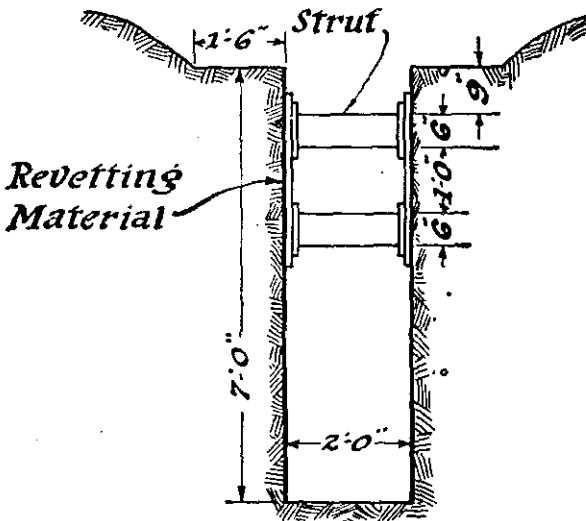

FIGURE 26.—Slit trench to protect against shell fire.

*f. Shallow connecting trenches.*—In order to provide for lateral communication along the line of fox holes, shallow connecting trenches are dug. The trench shown in figure 27 may be taken as typical. It has an average width of less than 2 feet and a depth of 1 to 1½ feet, and requires about 2 cubic feet of excavation per running foot of trench. With a parapet about 9 inches high such a trench provides cover for a man crawling on his hands and knees. When men are to occupy fox holes overnight, they usually extend the fox holes longitudinally, merging them with the shallow connecting trench so as to lie prone while sleeping. If occupied for several days, recesses with overhead cover may be prepared. Care must be taken to dispose of the spoil from such digging so as not to attract enemy attention to the work.

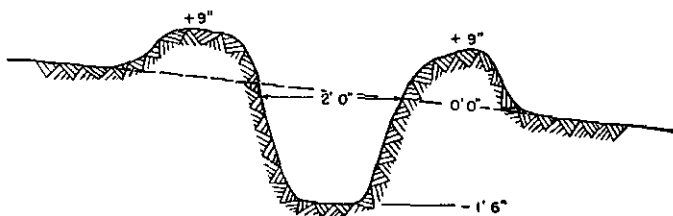

FIGURE 27.—Shallow connecting trench.

■ 35. DELIBERATE.—*a. General.*—In deliberate organization of a position construction of trenches is inseparably related to the other elements of field fortification. The entire defensive organization must conform to the tactical plan. The completeness of the system will depend on the time, materials, equipment, and labor available.

*b. Requirements.*—A deliberate trench must fulfill the following requirements.

(1) If a fire trench, it must have a good field of fire and permit the maximum use of the defender's weapons. It must lend itself particularly to development of flank or cross-fire as well as fire to the front.

(2) It must provide protection against enfilade fire by means of frequent abrupt general changes in direction. Both parallels and approaches that may be enfiladed by

observed enemy fire should make a general change in direction at least once in 100 yards (see fig. 30).

(3) It must limit the effect of a bursting shell through subdivision by means of frequent changes of direction.

(4) In order to reduce the number of projectiles that may fall directly into it, it must be as narrow as practicable, but it must not be so narrow as to make circulation within it unduly difficult or to render it easily blocked by caving.

(5) It must be sited to take advantage of natural drainage of the terrain and so constructed as to be adequately drained.

(6) It must be simple and easy to lay out and construct.

(7) In addition to the foregoing requirements, if a communication trench, it should be wide enough to permit two columns of men in single file to pass readily. If it is impracticable to provide such a width throughout the length, it must be widened at intervals to provide passing places. Where sharp changes of direction occur, the trench must be widened so that a bulky piece of equipment such as an open litter can be carried through easily.

(8) When the various platoon, company, and battalion areas of a defensive position are connected by parallels and approaches, the defensive lines thus created should assume bold curves in making major changes in direction additional to those prescribed in (2) above in order to increase the enemy's difficulty of organizing bombardments and barrage fire.

*c. Camouflage and concealment.*—(1) All trenches should be camouflaged or concealed from both air and ground observation insofar as practicable or, failing that, rendered as inconspicuous as possible. It is impossible to camouflage extensive trench systems except in woods. Individual positions within the trench system, for example machine-gun emplacements, shelters, and trenches approaching these positions, can be camouflaged effectively and with great benefit. Such camouflage combined with continuity and uniformity in trace and profile of the uncamouflaged elements of the position serves largely to withhold from the enemy knowledge of the detailed location and numbers of the garrison. See FM 5-20.

(2) It is possible to conceal trenches from ground observation to a large degree. Thus attacking infantry, although knowing the general location of trenches by means of airplane observation, are confused as to their detailed location and relative position and hampered in the attack. Full advantage should be taken of woods and brush. Freshly excavated earth that contrasts strongly with the surroundings should be covered with topsoil, sod, weeds, or brush. In general, avoid sharp or regular crest lines along parapet and parados; these lines should have the characteristics of surrounding terrain, and dimensions shown in illustrations should be modified as required to bring about this condition. Depressions in the parapet serve as firing embrasures, and the parados should be sufficiently high to prevent the heads



FIGURE 28.—Trench with irregular parapet and parados.

of the defenders of the trench from being seen in silhouette (see fig. 28).

*d. Clearing field of fire.*—(1) To comply with the condition that a field of fire of at least 100 yards is available in front of each fire trench, a certain amount of clearing may have to be done even in the most open country. Clearing a reasonable field of fire will ordinarily precede digging complete fire trenches or will at least be done concurrently with such organized excavation. In areas organized for close defense it is best to commence clearing work at the trench and work forward. In delaying actions where fire effect at long range is desired, any effort that can be directed toward clearing should be employed on areas distant from the trench. Before commencing any work the question of just how much may be accomplished in the time available should be determined since a field of fire only partially

cleared may give more cover to an attacking enemy than it did in its original condition. It is desirable to leave a thin natural screen to hide the position. A thin line of small trees or brush left standing may impede the enemy's observation and at the same time not hinder fire of the defenders.

(2) Large scattered trees, if left standing, give less cover to an attacker than if cut down and are sometimes useful as range marks. Unless they can be entirely removed or converted into dead abatis (see par. 43), only the lower branches should be cut off. Thick brushwood left standing may sometimes serve as an obstacle but Infantry can usually pass with ease any but the thickest growth of this kind. Therefore it is imperative to clear such growth. It is rarely possible or desirable to undertake the wholesale clearing of woods, and the work usually is restricted to clearing undergrowth and removing lower branches of the larger trees. Narrow lanes running obliquely in front of a line to be defended may be entirely cleared through woods and swept by automatic weapon fire.

(3) The tools found useful in clearing woods are axes, brush hooks, canthooks, hatchets, machetes, mattocks, and crosscut and power-driven saws. In situations where extensive clearing is necessary those classes of the above tools not found in quantity in equipment of combat units should be procured from the larger engineer supply establishments. Large trees may be cut down by the use of explosives but lack of large quantities of explosives for this purpose ordinarily makes it impracticable.

(4) The following table for an area of 100 square yards will be found useful in estimating time required for a given clearing.

Description of area	Method	Man-hours required
Covered with brush under 6 inches in diameter and containing 25 trees 6 inches to 2 feet in diameter (heavy clearing).	Chopping or sawing trees and clearing brush.	7
Covered with undergrowth and some trees not exceeding 12 inches in diameter (medium clearing).	do.	3.5
Covered only with small brush (light clearing).	Clearing brush.	1.5

(5) Walls should be demolished only when resulting debris will not give more protection than the wall itself. Sufficient gaps must be made in the wall in any case to give the defenders a clear view. Walls may be knocked down by use of a tree trunk or rail as a battering ram, or by use of power machinery or explosives if available and situation permits their use.

(6) The same principles apply to buildings as to walls. Low buildings may be knocked down. Larger buildings should be burned and walls left standing. This will usually prevent the upper stories from being used as observation posts and at the same time will not provide piles of debris in which the enemy may take shelter.

(7) Grain crops require somewhat the same treatment as woods. If ripe and dry, they may of course be burned. In the absence of mowing machines or in situations where such machines cannot be used, lanes must be cut with scythes.

*e. Standard traces.*—(1) *General.*—Standard trench traces must conform to the requirements of *b* above. Of the following standard types the one most suitable to the tactical situation and the terrain should be employed, special combinations and modifications being made to meet requirements of special conditions. It is understood that the actual trace will approximate only the geometrical precision shown in figure 29. Note in figure 29 that the fire bay for the octagonal trace trench is given as 16 paces or 40 feet. This is based on

an 8-man squad with allowance of 5 feet per man. If a larger squad such as one of 12 men is to occupy the trench, the fire bay may be correspondingly increased to 24 paces or 60 feet.

(2) *Octagonal*.—The octagonal trace is an excellent type for fire trenches in most situations. It provides excellent protection and localizes results of bursting shells.

(a) *Advantages* are that it—

1. Affords easy communication.
2. Facilitates oblique fire along the front.
3. Is an economical type to construct both as to labor and material.
4. May be provided with a continuous fire step.

(b) *Disadvantages* are that it—

1. Lacks simplicity of detail.
2. May be identified readily from the air as a fire trench.

(3) *Zigzag*.—This trace gives less protection from enfilade fire and shell bursts. Effectiveness may be increased by employment of short tangents and by occupation of alternate tangents. *Advantages* are that it—

(a) Is the simplest and easiest to trace, construct, revet, and maintain of all types.

(b) May be adapted readily to terrain.

(c) Is equally suitable for use as a fire or communication trench.

(d) May be provided with a continuous fire step.

(e) Provides for both frontal and flanking fire.

(4) *Wavy*.—Communication through this type is freer than for any other type, and it is therefore specially adapted for use for communication purposes. Advantages of the zigzag trace largely apply to the wavy trace. Slightly more labor and material are required for its construction than for the zigzag.

(5) *Echelon*.—The echelon trace is used for fire trenches when ground must be gained either toward or away from the enemy without subjecting the fire bays to enfilade fire. It may also be regarded as a zigzag trace fronting obliquely toward the enemy. It has advantages and disadvantages of that type of trace.

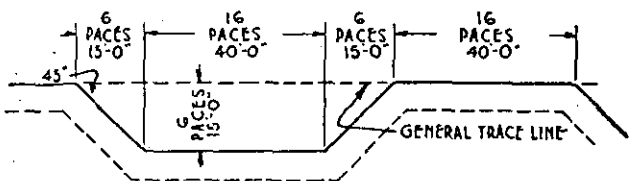

OCTAGONAL

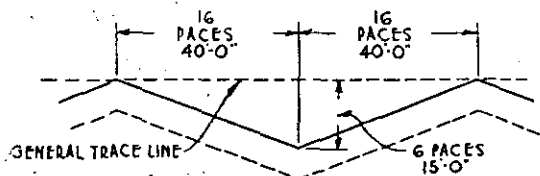

ZIGZAG

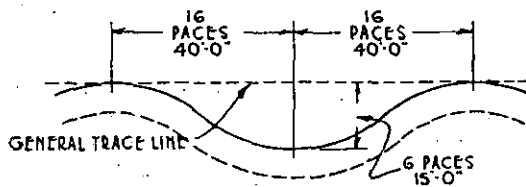

WAVY

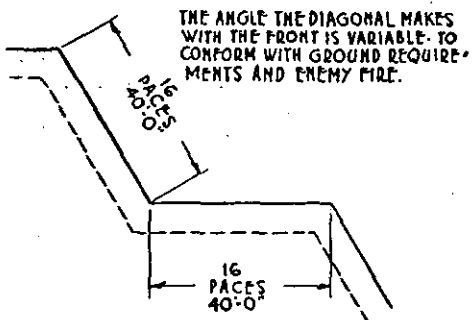

ECHELON

FIGURE 29.—Standard trench traces.



(6) *Modifications.*—By modifying angles of the zigzag or echelon into curves, those traces assume characteristics of a wavy trace. Such a modified or wavy trace, with the introduction of tangents at advantageous points, is a natural development during hasty intrenchment.

*f. Tracing.*—(1) *General.*—(a) *Method.*—Tracing trenches should always be supervised by an officer. If possible they should be traced with tape before arrival of digging parties. It is preferable to trace during the daytime. If enemy action prevents daylight tracing, favorable times are twilight periods at dusk or dawn. When a trench cannot be completely traced during the day it is usually possible to go over the ground during the daytime and locate controlling points with stakes, stones, or nails to which pieces of paper or rags may be fastened. This work should be done by an officer accompanied by qualified noncommissioned officers who later will be invaluable as guides for working parties. The salient points of the trench should be located with respect to easily recognizable landmarks, by azimuth and distance. If tape is not available, the trace may be marked with wire, twine, stakes, or stones, or the working party may be extended along the line thereby indicating it. The last method is most difficult to put in execution in the vicinity of the enemy and should be used only as the final resort. In case this is attempted it will usually be necessary to have noncommissioned officers pass along the line pacing off the distances and verifying and correcting the position of each man.

(b) *Controlling lines.*—Parallels are traced along the edge nearest the enemy and approaches along the right hand edge when facing the enemy. Width of the trench is then measured from the trace line by means of a gage stick, known lengths of intrenching tools, or by pacing.

(c) *Controlling dimensions.*—Figure 29 shows dimensions in feet and paces of the various standard traces. One pace is taken as 2.5 feet. It is habitual to trace trenches by pacing the various distances, greater refinement in making measurements being unwarranted.

(d) *General irregularities.*—General changes in direction should be introduced at intervals of from 75 to 125 paces as

indicated by figure 30 in parallels that may be enfiladed by observed enemy fire, and in approaches.

(e) *Tracing party.*—The tracing party consists of 1 officer, 1 noncommissioned officer, and 3 privates. It is equipped with tracing tape, 6-inch nails or stakes, and hammers or hatchets.

(2) *Octagonal.*—(a) The officer lays the tape along the general trace line established by the front edges of the fire bays.

(b) The noncommissioned officer accompanied by one private follows the general trace established by the officer, rolling up the tape as he goes. At the same time he paces off distances alternately of 16 and 6 paces and indicates to the private the ends of the fire bays. The private then drives stakes at these points. The noncommissioned officer also indi-

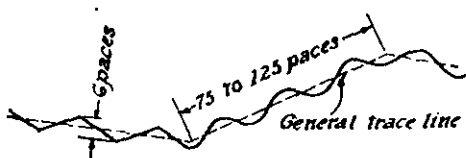

FIGURE 30.—General irregularities introduced in wavy and zigzag traces.

cates to the private points where offsets are to be taken. The private then paces 6 paces to the rear from these offset points and drives a stake, thus marking the ends of the rear bay. The noncommissioned officer makes minor adjustments as required.

(c) The two other privates stretch a tape along the line thus established, making a round turn at each corner. They provide additional stakes if required.

(3) *Zigzag.*—(a) The officer lays the tape along the general trace line which indicates general direction of the trench, providing slack for the zigzags.

(b) The noncommissioned officer accompanied by one private follows along the general trace pacing off distances of 16 paces and indicating these points to the private. The private takes an offset of 6 paces to the rear at every other point so indicated, and drives a stake. He drives a stake on

the general trace at the other 16 pace points. The noncommissioned officer makes minor adjustments as required.

(c) The two other privates stretch the tape taut between stakes, taking a round turn over each stake. They provide additional stakes as required.

(4) *Wavy*.—(a) Duties of the officer and noncommissioned officer are as indicated for zigzag in (3) above.

(b) One private drives a nail or stake at each corner located by the noncommissioned officer. The other two privates drive stakes to convert the straight portions of the zigzag into curves, and stretch the tape along the line of stakes thus established. About five or six stakes are required between the corner stakes located by the noncommissioned officer to provide the requisite sinuosity.

(5) *Echelon*.—The echelon trench may be traced as a zigzag trench running obliquely to the front or the officer in charge may indicate the various corners, the detachment then stretching the tape between them.

(6) *Tracing without tape*.—The same methods may be followed when tracing without tape as when tracing with tape, corners and intermediate points being marked by stakes or stones.

(7) *Variations*.—Other methods may be devised by an officer tracing trenches either with or without tape. A rigid conformity to forms and dimensions shown by figure 29 may not always be desirable. Full utilization of the defensive value of terrain and of all terrain features that may serve to conceal the trenches constructed, constantly observing the general provisions given in b above is of much greater importance. In case of a variation from standard dimensions, the officer specifies to the noncommissioned officer the exact length of fire bays, traverses, or diagonals he desires to use.

*g. Standard profiles*.—(1) *General*.—Trenches constructed in the face of the enemy and under difficult conditions necessarily vary in profile in order to meet those conditions. Standard profiles are prescribed for use except where unusual conditions require modification or do not admit complete execution. The standard profiles shown should be used in all instruction and training. They give a comparatively wide trench. Experience teaches that the advantage of additional

protection offered by a narrow trench is more than offset by the freedom of circulation provided by the wider trench and by the fact that the wider trench is not easily blocked by cave-ins. Officers and men should familiarize themselves with these profiles so as to avoid confusion and loss of time in constructing trenches under difficult conditions. It is understood that the exact geometrical preciseness shown in the illustrations will never be attained in actual practice. Reference is made to figure 20 showing terms adopted for the various parts of a standard trench. Standard profiles are shown in figures 31 to 35. Development of a simple standing trench into the A or B standard type is shown by figure 36.

(2) *Simple standing trench* (fig. 31) is unrevetted and provides no room for circulation in rear of the firing line. It is

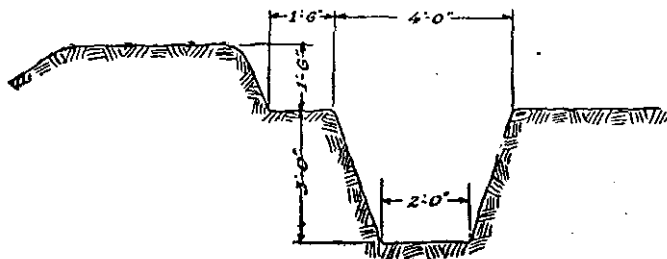

FIGURE 31.—Standard profile, simple standing trench.

the first profile sought when trenches must be constructed rapidly, but should be developed to type A in order to provide better cover and communication as soon as time, labor, and material permit.

(3) *Type A* (figs. 32 and 33) is unrevetted (except for parapet of fire trench and fire step) and therefore is the standard for hard ground where excavated slopes will stand without revetment. In soft ground this profile should be developed to type B as soon as time, labor, and material permit.

(4) *Type B* (figs. 34 and 35) is deeper and wider than type A, with lower half of the trench revetted throughout with A-frame supports and the upper half unrevetted. It has wide berms and easy slopes so as to avoid blocking of the trench by cave-ins under shell fire.

(5) Figure 37 shows a *wide communication trench (type C)* used in special cases for main thoroughfares in order to provide ample room for increased traffic, litter bearers, etc.

(6) The berms at top of A-frames (see figs. 34 and 35) may be omitted at first if necessary to save time and labor, and the

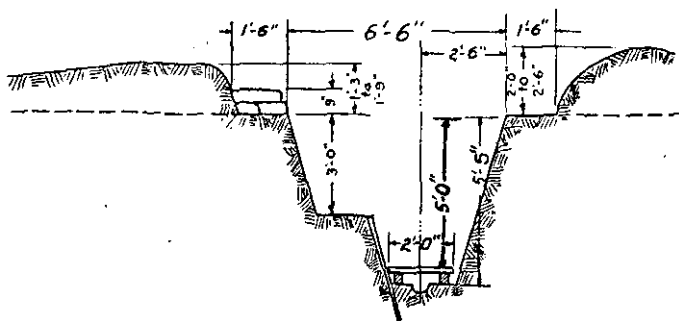

FIGURE 32.—Standard profile, fire trench, type A.

ground above sloped as shown by broken lines in the drawings. These berms however should be constructed as soon as opportunity affords in order to prevent the earth above from falling into the bottom of the trench and blocking the drain.

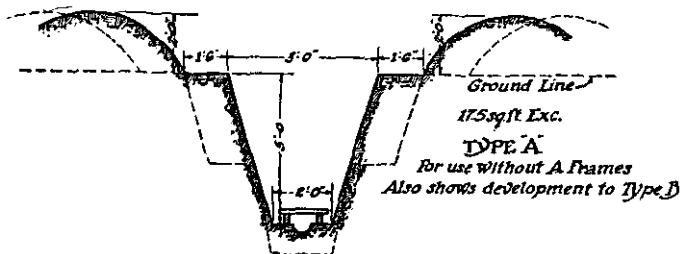

FIGURE 33.—Standard profile, communication trench, type A.

(7) The height of parapet adopted as a standard for fire trenches should be varied to suit conditions of terrain requiring more command, or where ground water or hard rock is encountered making excavation of the trench to full depth

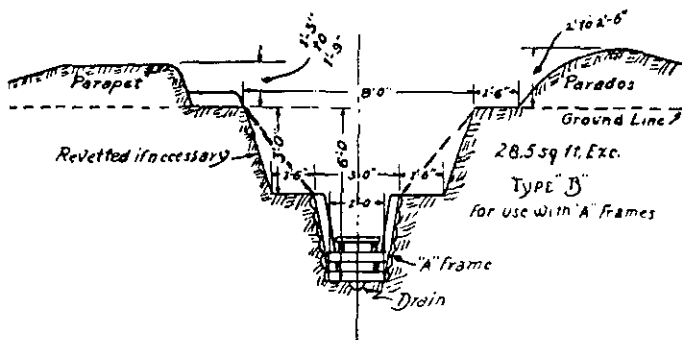

FIGURE 34.—Standard profile, fire trench, type B.

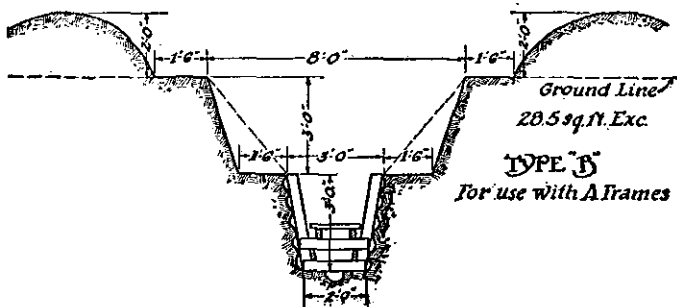

FIGURE 35.—Standard profile, communication trench, type B.

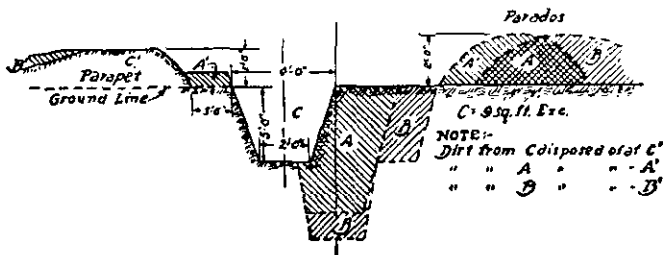

FIGURE 36.—Simple standing trench showing development into standard fire trench, types A and B.

impossible. In such a case profile of the trench except for the parados will remain the same, all parts of the trench bearing the same relation to each other, although the distance of any particular part above or below ground level will vary from the distance shown in figures.

*h. Intersections.*—An approach trench should enter a parallel at the rear of a bay. If it continues beyond the parallel

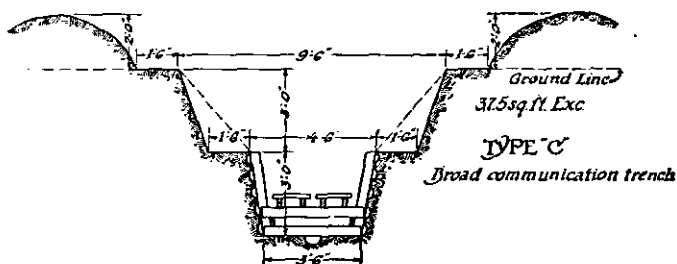

FIGURE 37.—Standard profile, wide communication trench, type C.

it should leave it at a point not less than 25 yards from the point of entrance. Trace of the parallel between these two points should be modified to provide easy communication (see fig. 38). A better solution is to provide two independent

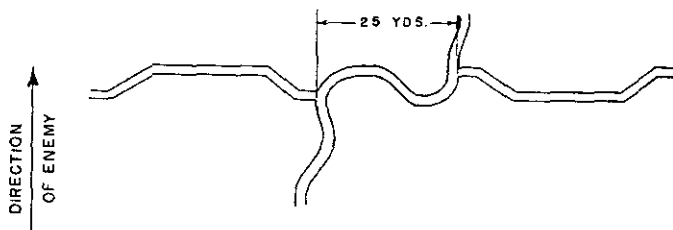

FIGURE 38.—Approach crossing parallel, octagonal trace.

crossings as shown in figure 39 in order that traffic may not be blocked if one of these crossings is destroyed.

*i. Intrenchment in presence of enemy.*—When deliberate trench construction is subject to interference by enemy fire, the work must necessarily take on some aspects of hasty

intrenchment. The trench will frequently have to be traced and dug at night. If it cannot be completed during a single night it should be dug to sufficient depth during the first night's work to afford adequate shelter for day working parties. Some work should be done all along the line and sections at intervals should be completed. The day working party extends these sections by sapping. As only one man can work in a heading at one time, he should work as rapidly

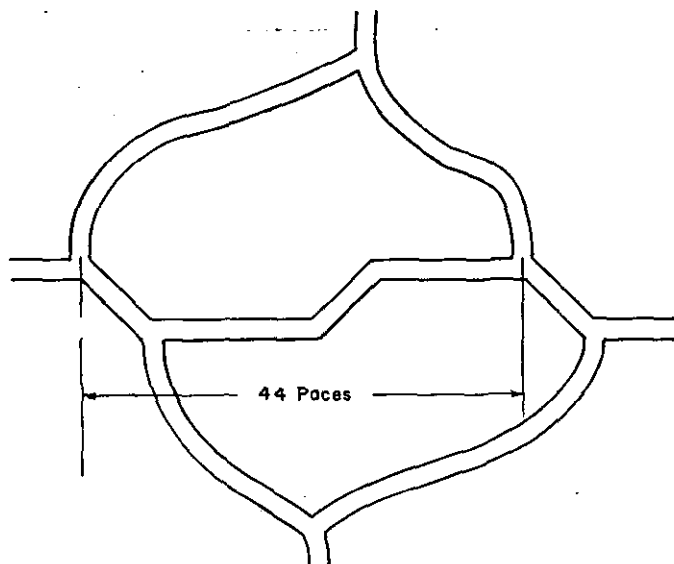

FIGURE 39.—Approach crossing parallel, octagonal trace, alternate method.

as possible and should be relieved frequently. Progress may be expedited by excavating in two stages, the first stage being construction by sapping of a trench similar to the standing slit trench (see fig. 25 (2)) and the second stage involving completion to profile dimensions. Trenches may be advanced by sapping methods from 1 to 4 linear feet per hour. When combat is imminent in order that working parties may not



be too fatigued to engage the enemy with effect, reliefs of not more than 4 hours should prevail.

*j. Planning and reconnaissance.*—(1) Deliberate intrenchments should always be carefully planned. Planning extensive intrenchments presupposes prior determination of their general location, extent, and mission. These points are properly covered in orders issued from higher headquarters of combat units to the officer responsible for construction of the works.

(2) The officer directed to take charge of construction of intrenchments is normally an engineer for extensive or complicated trench systems out of contact with the enemy, and an officer from the combat unit that is to do the work for lesser undertakings. Upon receipt of orders to proceed with the work he should visit and reconnoiter the site by day if possible. He should take with him a party to assist in tracing the works and later to serve as guides for working parties, if required. Preliminary reconnaissance having been completed, the intrenchments should be traced. When they cannot be traced completely by day it is frequently possible to go over the ground and mark controlling points. Locations of these points and length and direction of major lengths of the trenches to be constructed should be tied in to landmarks by azimuths and distances.

(3) Data determined as a result of reconnaissance should be—

(a) Sketch or overlay on an existing map or a position sketch showing general location, length, and azimuth of the principal straight stretches of the trench and relation of controlling points along it to existing works.

(b) Decision as to profile to be used.

(c) Estimate of nature of soil and proper proportion of tools.

(d) Estimate of total amount of material to be excavated.

(e) Estimate of time, men, tools, and materials required.

(f) Decision as to necessity for a covering force to protect the laboring force.

*k. Estimates of time, labor and tools.*—(1) If length of the general trace of a trench line is known, actual length

of trench to be dug may be found by multiplying by the appropriate coefficient, as follows:

Type of trace	Coefficient
Octagonal.....	1.09
Zigzag.....	1.07
Echelon.....	<sup>1</sup> 1.08
Wavy.....	1.11

<sup>1</sup> This will vary considerably with the actual trace.

(2) Table XIII gives figures for use in estimating time, labor, and tools required for trench construction. It is applicable to *day work* by *inexperienced men* using *pioneer tools*. The figures given represent the best performance that can be anticipated from large groups of soldier labor.

TABLE XIII.—*Day work, single relief, using pioneer tools*<sup>1</sup>

Soil	Number cubic feet of excavation per man in—							
	1 hr.	2 hr.	3 hr.	4 hr.	5 hr.	6 hr.	7 hr.	8 hr.
Hard <sup>2</sup> .....	15	24	32	40	47	54	61	67
Average.....	23	37	49	60	71	81	91	100
Light <sup>3</sup> .....	30	50	66	80	94	108	121	133

<sup>1</sup> This table contemplates a rest of 10 minutes every hour after the first hour.

<sup>2</sup> All must be loosened with a pick. Requires 2 picks to 1 shovel.

<sup>3</sup> Requires little or no picking. Requires 1 pick to 2 shovels.

(3) Estimates must be reduced from the totals indicated by table XIII for night work, rain or other unfavorable weather conditions, and annoyance by enemy fire, in the discretion and based upon experience of the estimating officer. *Night work is about two-thirds as effective as day work.* Night work should be planned to take full advantage of moonlight hours and duration and phase of the moon and probable cloud and weather conditions should be considered carefully when preparing estimates.

(4) A 5-foot length of trench (measured along the front edge of the trench) is a standard task for one man; the men should be spaced so that they can work efficiently and safely. In special cases when speed is essential and daylight work is possible, men may be spaced at 3.5-foot intervals. The men then should work at right angles to the axis of the trench as much as possible.

(5) If ample tools are available each man should be issued a pick and shovel. Otherwise, picks or shovels should be issued to men in the ratios indicated by table XIII, depending on nature of the soil.

(6) Experience teaches that soldier labor and untrained men in general become excessively tired after more than 4 hours' continuous work, and their output thereafter diminishes very rapidly. Men may be worked in one or in two or more reliefs. In the first case men work continuously with 10 minutes' rest out of every hour. In the second case there are two or more complete crews which relieve each other at intervals of several hours. A given piece of work may be completed more quickly using two reliefs, but compared to a single relief is not economical in manpower. The method of "doubled crews" may also be used. Here the men work in pairs; one man works as hard as he can for 4 or 5 minutes and then is relieved by the alternate man of the pair. The efficiency of a double crew is about 10 percent more than for one relief in light soil for 1 hour's work and about 30 percent more in hard soil for 8 hours. When working without enemy interference, in a standing position engineer tools are about 30 percent more efficient than infantry tools.

(7) With soldier labor, assignment of a definite task and provision for relief of the working unit upon completion of the task usually produce the best results. Under task assignments the output for any given period of time usually exceeds that indicated by table XIII. Tasks should be assigned by individuals, squads, platoons, or companies. Assignments should be such that each unit can return to camp or quarters when its task is completed. Great care must be exercised and the best experience available utilized in assigning tasks; once established, they should not be altered unless

found to be extremely unfair or entirely impracticable of accomplishment. With soldier labor, one-relief task assignments requiring approximately 4 hours for their completion are recommended. Such a procedure results in a maximum volume of excavation per man and permits employment of two reliefs, for example, one in the forenoon and one in the afternoon if work can be done during daylight hours.

(8) Experienced laborers using commercial tools which are larger and heavier than the pioneer tools can exceed by from 50 to 100 percent the quantities given in table XIII. Such labor should be worked an 8- to 10-hour day. Trained labor troops to be used continuously for pick and shovel work should be supplied with commercial tools and worked on an 8- to 10-hour daily schedule.

(9) While deliberate intrenchments can be constructed with the infantry tools carried on the pack, these tools are relatively ineffective as compared with pioneer tools. The use of infantry tools on deliberate works should be avoided if possible, but they are normally employed in connection with hasty intrenchments.

(10) Table XIV gives time required for completion of Type A and B trenches. It is computed from table XIII.

TABLE XIV.—Hours required to complete 3½-foot and 5-foot tasks; or if not completed, percentage finished in 8 hours of day work, using pioneer tools

Nature of soil	Type A unrevetted								Type B revetted			
	Fire trench				Communication trench				Fire and communication trench			
	One relief		Two reliefs		One relief		Two reliefs		One relief		Two reliefs	
	3½ feet	5 feet	3½ feet	5 feet	3½ feet	5 feet	3½ feet	5 feet	3½ feet	5 feet	3½ feet	5 feet
Hard.....	85%	60%	5.5	7.25	7.0	75%	4.0	5.75	65%	45%	7.00	80%
Average..	5.75	90%	3.5	5.0	4.0	6.75	2.75	4.0	95%	65%	4.5	6.5
Light.....	3.75	6.0	2.5	3.5	2.75	4.5	2.0	3.0	6.00	85%	3.5	5.0

(11) When preparing estimates the following points should be kept in mind:

(a) Do all work by daylight if possible.

(b) When night work is required, do some excavation along the entire length of the trench the first night; at least complete section C, figure 36, which should require from 2 to 6 hours' work for 5-foot tasks. Complete the type A profile the first night if possible.

(c) In general, when using soldier labor, use the one-relief task assignment system. The tasks should require approximately 4 hours for their completion and the standard 5-foot assignments should be employed. Use two such reliefs with task assignments when speed is essential and plenty of men are available.

(d) Use the 3½-foot assignment only in case of emergency.

(e) Increase estimates for labor and tools by at least 5 percent to allow for contingencies.

(f) Request covering force, antimechanized, antiaircraft, and gas warning personnel for protection of laboring force when presence or activities of the enemy require it.

■ 36. DRAINAGE.—*a. General.*—(1) Drainage of trenches is of the utmost importance. Improper drainage not only may have serious effects on health of the occupants but may interfere so much with use of trenches as to contribute materially to the failure of military operations.

(2) The question of proper drainage must be considered when siting trenches, during their construction, and also during their occupation. A small amount of forethought may later save a large amount of labor.

(3) Drainage plans should be prepared before construction is commenced. If this has not been done they should be prepared by the officer commanding the occupying troops as soon as possible. Drainage plans should be prepared and the work these plans call for completed during dry periods so that the trenches may be of use during wet weather.

(4) Surface water must be excluded. It is much easier to prevent its flow into the trench than to remove it once it has gained access.

(5) Water may be disposed of by—

(a) *Drainage ditches* that conduct the water by natural flow into nearby drainage lines.

(b) *Sumps* that either penetrate permeable soil and dispose of the water by percolation or collect the water for disposition by pumping, siphoning, or bailing. Combination of sump for collecting the water over a drill hole penetrating permeable soil, and disposing of same by percolation through the drill hole.

(6) Sumps should never be installed when the water can be disposed of by drainage ditches of reasonable length.

(7) A moderate slope of 1 percent, that is, 1 foot in 100 feet or  $0^{\circ}35'$ , is desirable. If the slope is excessive, damage by erosion may result.

(8) The eye cannot be relied upon to determine differences of level in connection with drainage. A carefully adjusted clinometer, spirit level, or in important cases, a surveyor's level should be used.

(9) Presence or absence of underground water when in doubt should be determined by digging test pits before starting construction of extensive field works. In some localities it is so abundant or so close to the surface as to require use of high parapets or breastworks instead of trenches. Except in such localities ground water is unlikely to interfere with the works discussed in this section. With respect to construction of deep cave shelters, however, the subject is more important.

b. *Sites*.—(1) Trenches should not be located in marshy or boggy ground unless it is absolutely unavoidable.

(2) Communication trenches should not be located in the bottom of valleys or gullies but should be placed along the side slopes.

(3) Special care must be taken to site trenches so that all parts can be easily drained toward naturally low points in the line, avoiding any unnecessary sag which will be difficult to drain later (see fig. 40).

(4) Never site a trench exactly along a contour, but give it enough slope to carry the water in the desired direction as shown in figure 40.

*c. Construction.*—(1) Plan for drainage from the beginning. First, start the drainage ditch or sump, always keeping progress of its excavation in advance of that of the trenches draining into it.

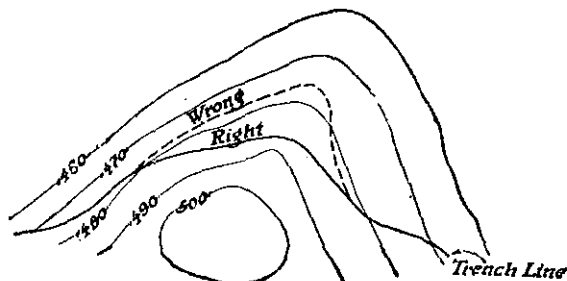

FIGURE 40.—Siting trenches to eliminate low spots.

(2) Complete excavation progressively upgrade when practicable so as to avoid formation of undrained pockets in the bottom of a partially completed trench.

(3) Gutters or intercepting ditches should be provided on the uphill side of trenches for collecting surface water and conducting it to a natural watercourse. The parados

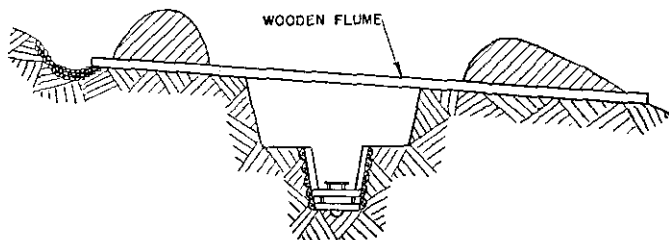

FIGURE 41.—Surface water carried over trench.

sometimes may be made to serve this purpose. If necessary, these surface ditches are carried over or under the trenches (see figs. 41 and 42).

*d. Maintenance of system.*—(1) Maintenance of the drainage system is the duty of the troops occupying the sector. Responsibility for maintenance of drainage of all trenches

within a given area devolves upon the commander of that area. This responsibility includes communication trenches, the drainage of which is as important as that of occupied trenches and is more apt to be neglected.

(2) In a sector which is to be occupied for sometime, a small force should be detailed to inspect and maintain the drainage system. It should be charged with keeping all drains and sumps clear, including the intercepting ditches for surface drainage.

(3) - All caving surfaces must be repaired, and earth thrown into trenches by shell explosions must be removed at once. Constant attention to this matter will save a large amount of labor later, as water backing up in a trench will cause additional caving.

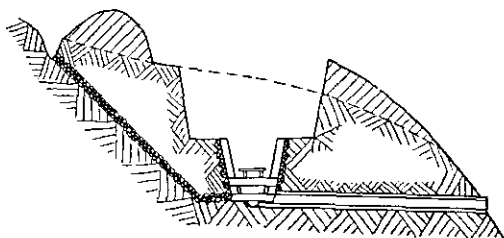

FIGURE 42.—Surface water carried under trench.

(4) In level country sign boards marked DRAIN and bearing an arrow showing direction of flow should be placed at appropriate points in trenches in order that this direction may be known when cleaning out ditches.

(5) An excellent way to determine measures necessary for maintenance of the drainage system is to inspect it during or immediately after a rain.

*e. Flooring.*—(1) Trench boards (fig. 43) when available should be placed in the bottom of all trenches, except on rock. In firm ground they may be laid without special supports, or merely with the ends supported on short boards laid transversely across the bottom of the trench. In soft ground they should always be supported on trestles (fig. 44) or on the A-frames used for revetting (see figs. 47 and 48). Trench boards are lightly fastened down as they must not



be continually getting out of position on the one hand, and must not be too difficult to raise when cleaning out drains on the other.

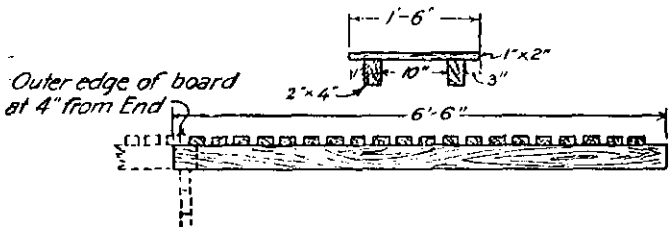

FIGURE 43.—Trench board.

(2) Serviceable trench flooring may be improvised from planks or boards of usual dimensions or from trunks of small trees.

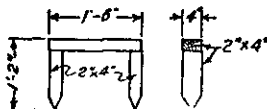

FIGURE 44.—Trench board trestle.

(3) In rock or very hard ground where trench boards are not required, the bottom of the trench should as far as practicable be crowned as shown in figure 45. Undercutting of



FIGURE 45.—Trench without flooring.

the side slopes in order to secure space for side ditches should never be permitted.

*f. Sumps.*—Sumps should if possible reach porous strata. Their efficiency for disposal of water by percolation can sometimes be greatly increased by drilling a hole and shooting

a small charge of explosive some distance below the bottom to loosen up the ground. They can be located underneath the trench boards or in an offset.

*g. Pumping and bailing.*—(1) Pumps are sometimes necessary for removing water from sumps. Classes of pumps furnished complete with suction and discharge hose usually available are—

(a) Hand-force, to be operated inside the trench by one or two men.

(b) Hand-suction, to be operated outside the trench by one or two men; limit of suction approximately 16 feet.

(c) Gasoline-driven force, for use in special cases; limit of suction approximately 20 feet.

(2) Bailing scoops or galvanized iron buckets may be used for bailing out sumps.

■ 37. REVETMENTS.—*a. General.*—(1) A revetment is a retaining wall or facing for maintaining earth slopes at a steeper angle than their natural angle of repose.

(2) Revetments may be classified as—

(a) *Retaining wall* type, which is self-supporting and acts on the gravity principle for retaining walls. It is largely used in connection with fills, parapets, and breastworks.

(b) *Surface or superficial* type, which must be supported and acts largely by protecting revetted surface from disintegrating and erosive effects of weather and from abrasion due to occupation of trench. When strongly constructed it may also serve to retain loose materials and prevent settlement. It is used principally in cuts.

(3) A good revetment must possess—

(a) Simplicity of detail.

(b) Adaptability to available materials.

(c) Ease of fabrication and erection.

(d) Low fragmentation under shell fire.

(e) Ease of removal from obstructed trenches.

(4) In general, revetments should be constructed only when obviously required and should not be more extensive than necessary. They require a great deal of labor and material and should therefore be avoided if possible. On the other hand, during long occupation of trenches and when

time, labor, and materials are available, extensive revetments make the garrison more comfortable and reduce maintenance.

(5) If sides of the excavation are carefully sloped the amount of revetment required is greatly reduced. Unevenness causes rain to lodge in or erode the surface, to soak into the earth, and results in rapid disintegration of the slope. The steeper the slopes of a trench the greater is the need for revetment to prevent them from caving.

(6) The interior slope of the parapet of fire trenches (not the entire front slope) is always revetted. In addition, only the lower 2 or 3 feet of a trench usually require revetment. For standard profiles as shown in figures 32, 34, and 35, this involves revetment to the level of the fire step or lower berm. Such revetment supports portions of the trench subject to the most wear, preserves drainage, is seldom injured by the enemy's fire, and preserves the profile of the bottom of the trench for clearing after a cave-in.

*b. Retaining wall types.*—As these revetments must be self-supporting they should always take the form of a properly built retaining wall. The thickness at any level should be at least one-half the remaining height and the average thickness not less than one-third of the total height. Amount of excavation required for retaining wall types is considerably greater than for surface types.

(1) *Sandbag.*—This type is easily and quickly constructed, does not splinter from shelling, and is especially useful for emergency work, for repairs, crowning, and revetting the interior slopes of parapets.

(a) The standard sandbag is 14 by 26½ inches flat, with an attached tie string 3 inches from the top of the bag. When filled three-fourths full, each bag weighs from 45 to 75 pounds depending upon material and whether it is wet or dry, averaging approximately 65 pounds, and fills a space approximately 4¾ by 10 by 19 inches. Thus 10 linear feet of parapet revetment for type A fire trench, as shown in figure 32, requires 24 sandbags, and 10 linear feet of revetment for front slope and parapet of Type B fire trench, as shown in figure 46, requires 132 sandbags.

(b) When laying sandbags attention should be paid to the following points:

1. Fill bags uniformly about three-fourths full.
2. Build revetment at slope of from 3 on 1 to 4 on 1.
3. Lay bags perpendicular to slope.
4. Lay bottom row headers on prepared bed. Alternate intermediate rows as stretchers and headers and complete with a top row of headers.
5. Lay bags with seams and choked ends inward.

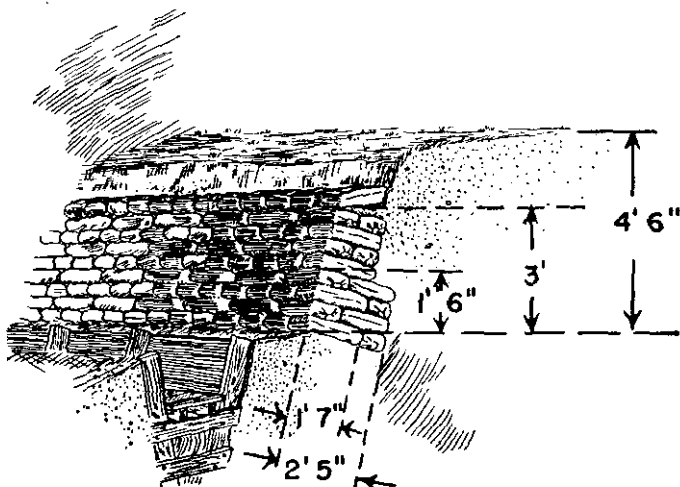

FIGURE 46.—Sandbag revetment.

6. Break joints. Beat bags into a rectangular shape with the back of a shovel and tuck corners of bags in when placing.
7. A sandbag revetment will last much longer if wire netting, preferably doubled, is placed over the face.

(2) *Sod* is more durable than sandbag revetment, and its use is recommended where sods can be obtained in sufficient quantity. Sodds are cut 18 by 9 inches, laid grass down except the top layer, and pinned together with wooden pegs. The provisions given above for sandbag revetment apply.

(3) *Stones and bricks* may be used for revetment in the form of retaining walls laid dry, in which case a slope of not steeper than 4 on 1, laid at right angles to the face, and broken joints are especially important. Due to danger from flying splinters in case a stone revetment is hit by a shell, its use is not recommended where other material is available. If used in a parapet it should always be crowned with earth-filled sandbags.

c. *Surface types*.—(1) *General*.—This form of revetment consists of two parts, the revetting material which retains

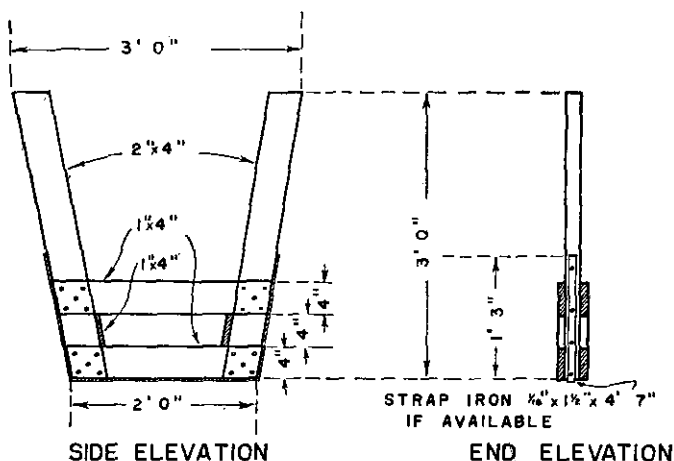

FIGURE 47.—Standard A-frame.

the earth, and the supports which hold the revetting material in place. It is most useful in retaining slopes of trenches since little additional excavation is needed.

(2) *Supports* may be standard A-frames, pickets, or struts.

(a) *A-frames*.—Standard A-frames are used in the bottom third of the trench, placed 3 feet center to center and support material described above (see figs. 47 and 48). Methods of placing these frames around corners in octagonal trenches are shown in figure 49.

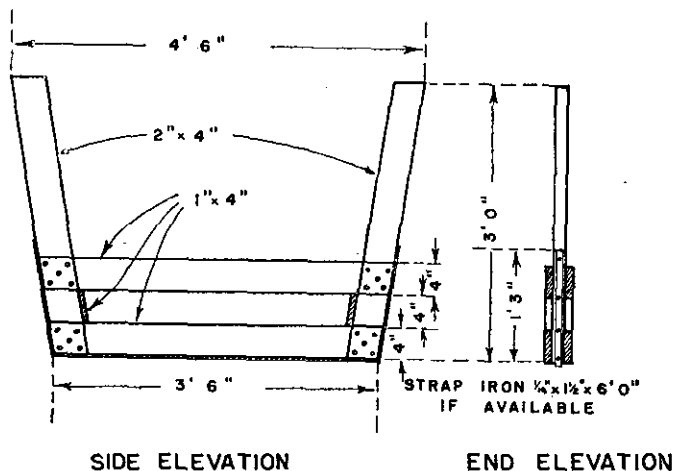

FIGURE 48.—Special A-frame for use in communication trench, type C.

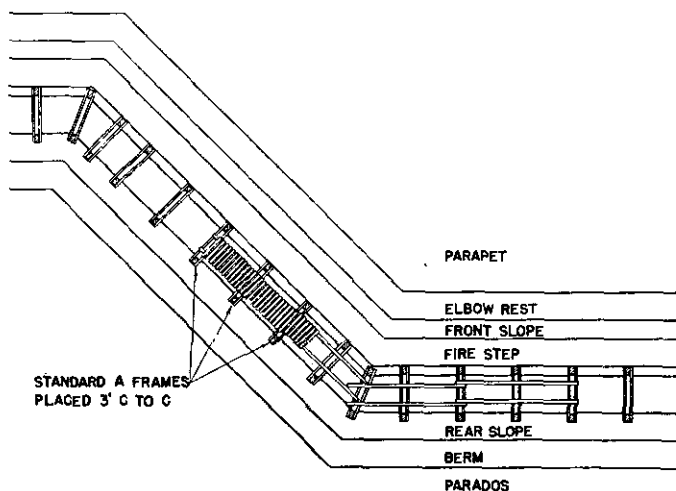

FIGURE 49.—Placing A-frames.

An estimate sufficiently accurate for all practical purposes of the number of A-frames and trench boards required for any given frontage of trench may be made as follows:

1. *A-frames.*

*Octagonal trace*=

[frontage (in yards) + 10 percent (to convert frontage to length of trench) + 10 percent (to provide for angles in trench)]

*Zigzag, wavy, and echelon traces*=

frontage (in yards) + 10 percent

2. *Trench boards.*

Single walkway=

$$\frac{\text{Number A-frames}}{2}$$

Double walkway=

Number A-frames.

Thus a frontage of 1,000 yards of octagonal fire trench type B, using standard A-frames and single walkway requires:

$$\text{A-frames} = [1,000 + 100] + 10 \text{ percent} = 1,100 + 110 = 1,210.$$

$$\text{Trench boards} = \frac{1,210}{2} = 605.$$

For the same frontage of wavy, communication trench, type C (wide communication trench), using special A-frames and double walkway:

$$\text{A-frames} = 1,000 + 100 = 1,100.$$

$$\text{Trench boards} = 1,100.$$

(b) *Pickets.*—If A-frames are not available and the soil permits, the revetment may be supported by means of pickets driven into the bottom of the trench and braced, as shown in figure 50. *Anchored pickets* are used when revetting front slopes of fire trenches (fig. 51), or in other special cases where high revetment is required. Revetting pickets should be from 2 to 3½ inches in diameter, straight, pointed at the small end, and driven into the ground from 1 to 1½ feet. Light angle-iron pickets may also be used. Lateral spacing of pickets varies with soil and character of working materials. For example, burlapped chicken wire requires more closely spaced supports than sheets of corrugated iron. Similarly, sand requires more support than firm clay. Spacing may vary

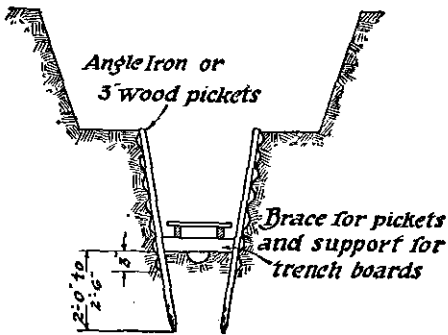

FIGURE 50.—Braced revetting pickets.

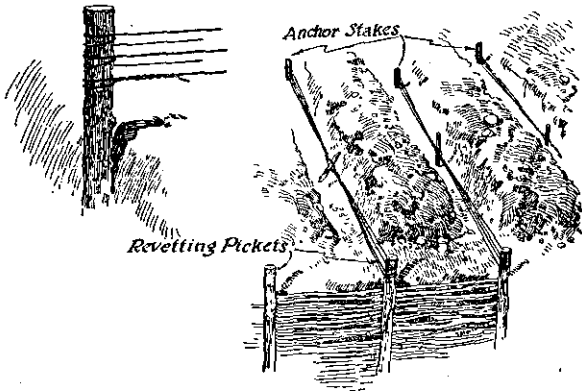

FIGURE 51.—Method of wiring and anchoring revetment.



from  $1\frac{1}{2}$  to 6 feet. Anchor pickets should be driven firmly into solid ground 8 to 10 feet from the edge of the trench, staggered so as to avoid forming a plane of weakness parallel to the trench, and inclined so as to be perpendicular to direction of pull on the anchor wire. Anchor wires, preferably No. 14 American wire gage, should pass at least four or five times between picket and stake. Each strand should take a round turn around the head of the anchor picket and then the strands should be twisted together with a short stick to tighten them.

(c) *Struts* resting against opposite walls of a trench are for use only in narrow, deep trenches in which there is little circulation as in shell slits for protection against shell fire as shown in figure 26.

(3) *Revetting materials* may consist of expanded metal, wire netting (chicken wire), corrugated iron sheets, brush-wood hurdles, burlap, canvas, poles, brush, or lumber, or combinations of these materials, depending on the materials available and nature of the soil.

(a) *Expanded metal and wire netting* are used most effectively either alone or in combination with burlap, canvas, or similar materials. The burlap checks evaporation and prevents disintegration and erosion, and the metal or netting supports the burlap. If burlap or similar material is not available, grass, leaves, twigs, etc., may be substituted with good results. In placing expanded metal or wire netting revetment (fig. 52) the following operations are necessary:

Cut vertical grooves for the anchor pickets throughout length of bay at spacing decided upon.

Drive the two end pickets of each bay first and anchor them back loosely.

Stretch the metal or a double thickness of netting behind the two end pickets, holding it taut until these pickets are pulled into their grooves by tightening the anchor wires.

Drive remaining pickets and anchor them back, thus drawing revetting material tight against surface to be revetted.

(b) *A continuous brush revetment* of the superficial type may be constructed by driving pickets from  $2\frac{1}{2}$  to 3 inches in diameter at about 1-pace intervals along the face of surface to be revetted and about 4 inches from it. Tops of pickets

should project above the ground. The space behind the pickets is then packed with small straight brush laid parallel to the surface and held in place by the pickets which are drawn back firmly by means of wire and anchor pickets.

*d. Brush work.*—(1) In practically all wars brush has been used extensively in revetment and improvement of earthworks. While its value in modern warfare is not always commensurate with labor and skill involved in its use, its flexible utility and ready availability in forested areas will still result in its extensive use in the future. At times it may be the only material available. It may be used as continuous revetment already described, or as hurdles, gabions, fascines as described below; or any combination of these.

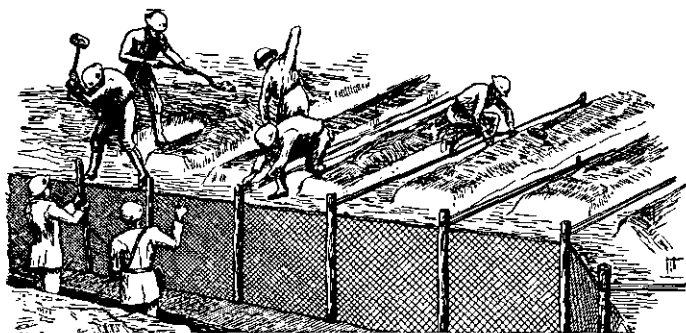

FIGURE 52.—Constructing wire mesh revetment.

(2) Almost any kind of brush reasonably straight, tough, flexible, and free from refractory branches, dangerous thorns, or other objectionable characteristics is suitable, but willow, birch, ash, hickory, hazel, and similar woods are desirable. Split bamboo of pliable dimensions, reeds, and vines are also valuable. Brush for weaving should not be more than an inch in diameter at the butt. That to be used without weaving may be of larger size. When cut, brush should be assorted in sizes for the various uses and made up in bundles weighing 40 to 60 pounds, the butts in one direction. Poles of 2½ inches diameter at the butt or larger end are not bundled but are piled together. They are used for posts,

pickets, struts, binders, grillage, and similar purposes. It is frequently best to fabricate hurdles, gabions, or fascines at the point where the brush is cut, later transporting finished brush work to the point of use.

(3) A *brushwood hurdle* is a woven revetment unit, usually 6 feet long and of the required height (see fig. 53). It is constructed on sharpened pickets which are driven 18 inches into the ground and then moved to location in the trench.

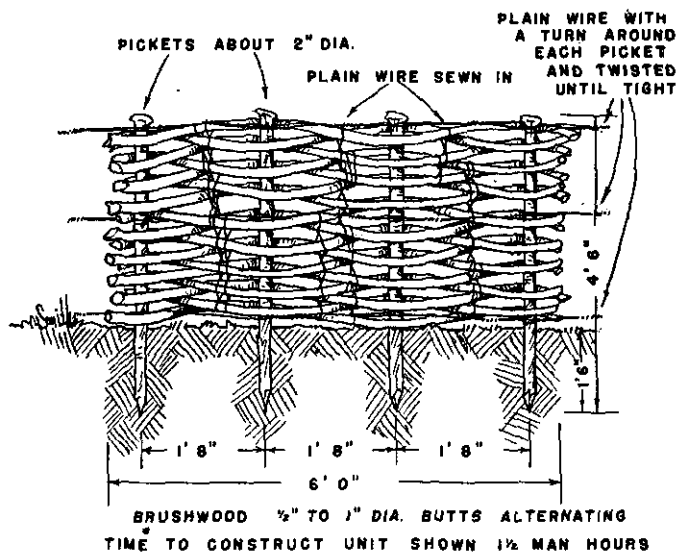

FIGURE 53.—Brush hurdle.

(4) A *gabion* (fig. 54) is a cylindrical basket with open ends made of brush woven on pickets.

(5) (a) A *fascine* (fig. 55) is a cylindrical bundle of brush closely bound. The usual length is 18 feet and the diameter 9 inches when compressed. Lengths of 9, 6, and 3 feet when needed are conveniently obtained by sawing a standard fascine into pieces.

(b) When a large number of fascines is required and brush is plentiful at one point, a portable frame as shown in figure 56 may be constructed.

(6) Hurdles make an excellent surface revetment and are used extensively for that purpose. Gabions are used principally in the construction of parapets and breastworks in wet ground (fig. 58) and to a limited extent in repair of caved-in trenches. Fascines may be used to advantage at the back edge of the firing step, that is, at the top of the surface revetment of the lower third of a standard profile. They stand

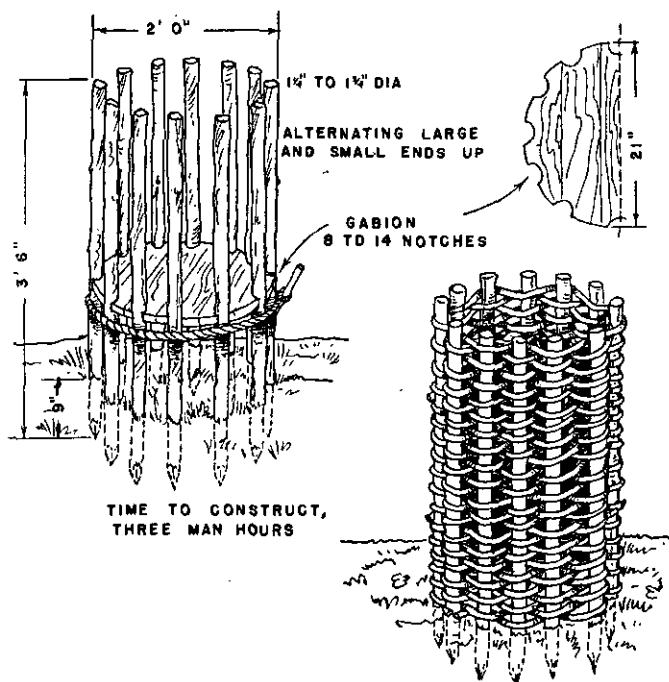

FIGURE 54.—Brush gabion.

wear much better than sandbags. Fascines may also be used in connection with footings for gabions and as a crown for gabion, hurdle, or other types of revetment. Figure 57 shows a gabion and fascine breastwork topped with sandbags.

*e. Revetting materials carried in engineer supply establishments.*—Sandbags, corrugated iron, expanded metal, metal

lath, wire netting (chicken wire), pickets (including light angle-iron pickets), and binding wire are normally carried in the engineer sections of army depots, corps parks, division dumps, and division distributing points.

■ 38. BREASTWORKS.—If need for additional command or presence of water, rock, or very hard material makes construction of standard trenches impracticable, breastworks must be constructed. Profile of the breastworks should ap-

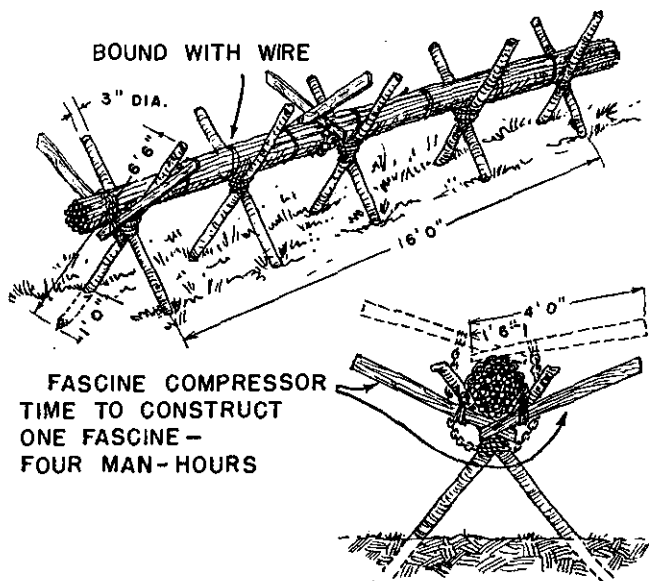

FIGURE 55.—Brush fascine and cradle for fabrication.

proximate the standard trench profile as nearly as possible. A parados should be constructed to protect against the back blast and fragments from shells. In some cases the entire protection above the fire step may be constructed in full and be revetted as shown in figure 58. Angles are provided as in standard trenches. Careful provision for drainage in wet soil may greatly reduce the height of the breastworks and consequently the labor required for their construction.

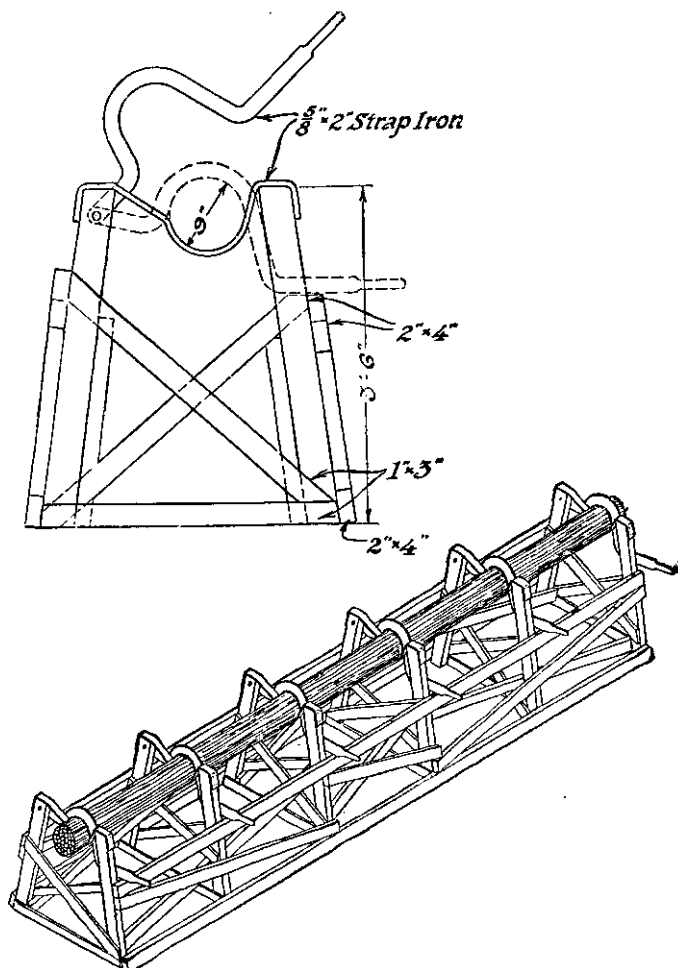

FIGURE 56.—Portable frame for compressing fascines.

■ 39. ACCESSORIES.—*a. General.*—Any special work or facility designed to increase usefulness of an intrenched position or to provide for the safety, comfort, health, or convenience of the garrison is called a trench accessory. Continued occupation of a trench system results in a great demand for and rapid multiplication of such accessories. Types of frequently

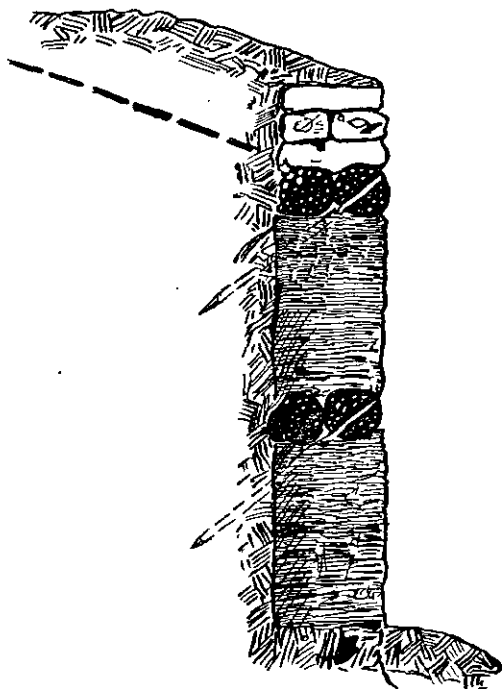
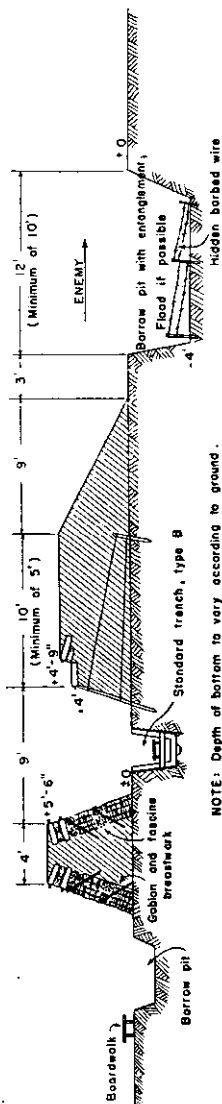

FIGURE 57.—Gabion and fascine breastwork topped with sandbags.

constructed accessories are described below. Trench accessories are ordinarily built by the troops occupying a position.

*b. Observation posts.*—(1) Observation posts vary widely from very simple ones in open warfare to rather elaborate structures in position warfare. In any defensive position they also vary in simplicity, depending on their location with



NOTE: Depth of bottom to vary according to ground.  
Set frames as low as possible to save breastwork.

FIGURE 58.—Breastworks in wet soil.



respect to the enemy. They may be located well forward for surveillance of a limited portion of the enemy's position or well to the rear where a considerable area may be kept under observation.

(2) The first requisite of a good observation post is a clear view of the area or position it is desirable to keep under observation. Immunity from enemy fire is the next consideration. This may be secured by concealment which is always of paramount importance. If time and material are available it may be desirable to secure additional immunity by providing cover so that personnel may occupy the post in safety during a general bombardment. Importance of nullifying the defenders' observation is so great that the attacker will use every means to attain this end. If an observation post is discovered it is almost sure to be shelled prior to an attack. Unless it affords sufficient cover to withstand such a shelling its usefulness ceases. Inasmuch as it will not often be practicable to provide such cover, importance of concealment becomes still more evident.

(3) In the first stages of a defense, observation posts will generally be located in existing structures or terrain features where concealment and as much protection as possible may be secured. Thereafter as time is available for such work, such locations may be strengthened and shelter built to increase the comfort and security of the personnel occupying the post. Suitable means of signal communication between observation posts and command posts must be arranged. As complete stabilization takes place, special structures for use as observation posts may be erected. These are of two general classes, periscope and direct view, some of which are described below.

(a) *Periscopes* may be disguised as trees, stumps, telephone posts, etc. For small trench periscopes advantage is taken of any natural object such as a stump or broken stick projecting from the parapet to provide concealment. Periscopes should be installed at night and all precautions must be taken to prevent the enemy suspecting their existence. Serviceable periscopes may be improvised when necessary by using two mirrors and pieces of light box material.

(b) Small *direct view* observation posts may be located either in the trenches themselves or in saps leading from them. There are two general types, cabin and portable. A cabin observation post is shown in figure 59.

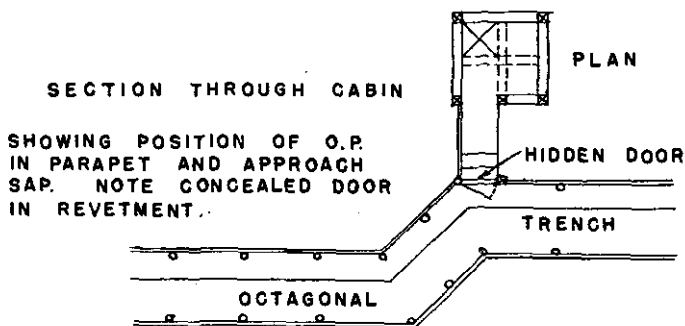
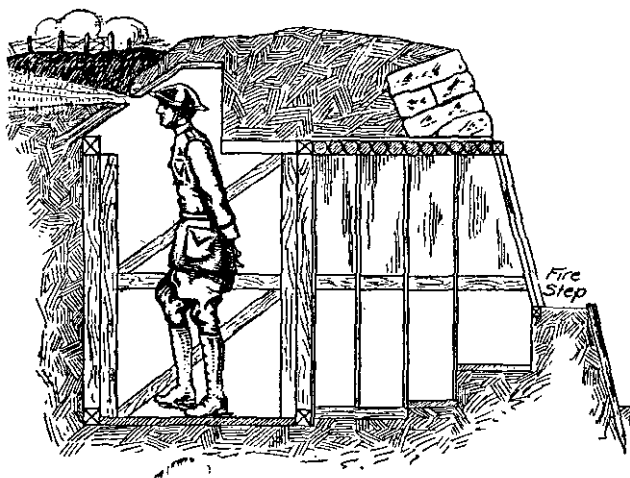

FIGURE 59.—Cabin type observation post.

(c) *Portable* observation posts may be either armored or unarmored. Figures 60 and 61 show two bullet- and splinter-proof types. Unarmored types may be readily improvised from various kinds of material. They are frequently made

to be set into the parapet of a trench. Affording no protection, they must be entirely inconspicuous.

(4) Observation posts are frequently located to give an oblique view to the front which makes it more difficult for an enemy observer directly opposite to locate them. Usual reasons for discovery of a post of this kind are either trails to it or presence of a number of men in its immediate vi-

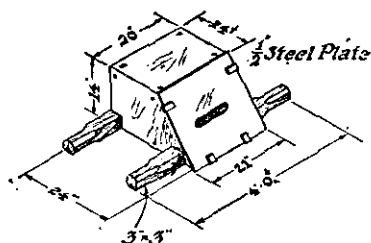

FIGURE 60.—Portable armored observation post.

cinity. It may be advisable to camouflage the entrance to a parapet observation post so that the observer will not be caught by raiding parties and will have a greater feeling of security and therefore function more efficiently.

(5) In addition to these forward observation posts, very elaborate posts to the rear are sometimes employed in suit-

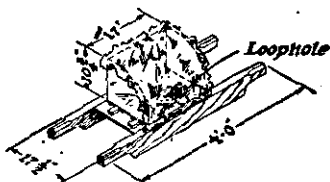

FIGURE 61.—Roll-top steel observation post.

able terrain. They are located so that they command an extensive view of the enemy's position and are usually far enough to the rear to be safe from minor attacks. They are provided with excellent observing instruments and have telephonic connection with the higher headquarters. Such emplacements are built very solidly, often in the manner of con-

crete machine-gun emplacements (see par. 48e (4)). Care should be taken to prevent their location becoming known to the enemy.

*c. Command posts.*—(1) In a hasty position a command post may consist merely of a trench to contain personnel if shell holes, natural protection, or buildings are not available (see pars. 48d (9) and 64).

(2) A simple trench may be made splinterproof for use as a command post by covering it with a layer of logs and at least 1 foot of earth as shown in figure 62.

(3) The trench itself is not of sufficient size for continued occupancy as a command post and in order to facilitate

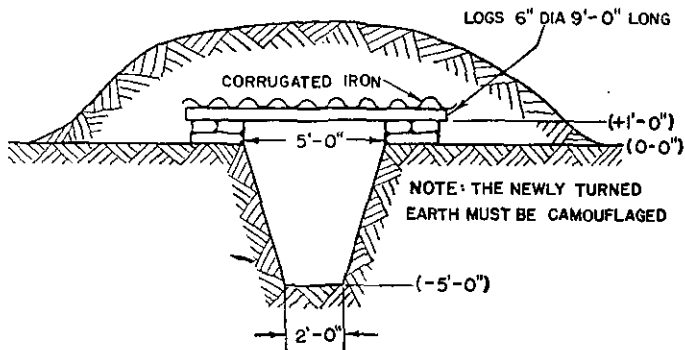

FIGURE 62.—Splinterproof trench for command post.

movement at the command post splinterproof compartments may be constructed in the side of the trench (see fig. 63).

*d. Sniper's posts.*—(1) Sniper's posts are located and used by specially detailed men. The posts should be marked plainly and all persons except snipers forbidden to use them. As a rule they are located within 400 yards of the enemy.

(2) Requirements of a sniper's post are—

(a) Concealment from enemy observation.

(b) Good view and field of fire over a designated section of the enemy lines.

(c) Two loopholes are desirable but not essential, one for the rifleman and one for an observer.

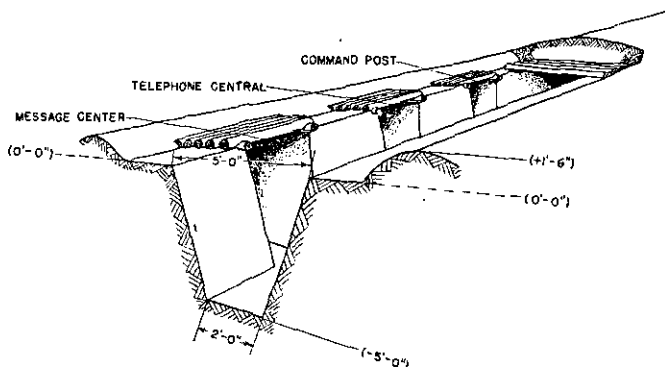
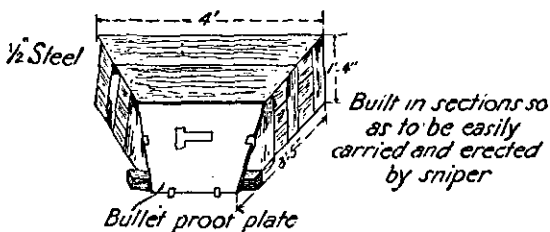

FIGURE 63.—Splinterproof command post with compartments constructed in side of trench.



SECTION showing shelf as rifle rest .  
also usual manner of placing in mound  
Front armored plate has camouflaged  
cover

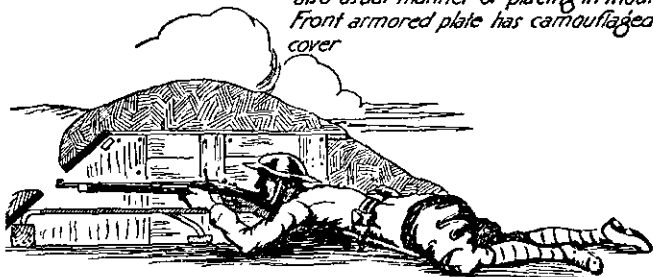

FIGURE 64.—Sniper's post.

(d) Curtain behind each loophole and a stopper or "gag" to be pushed into each loophole from the inside.

(3) Figure 64 shows a portable sniper's post which can be shifted readily from one location to another in a night.

*e. Ammunition and grenade boxes.*—Boxes let into the trench walls to contain reserve ammunition and grenades are desirable in fire trenches and machine-gun emplacements. Boxes should be placed in the front wall of the trench or beside the loader of an automatic weapon, and to avoid interference with use of the trench should be flush with the surface of the ground. They should be covered with roofing paper to make them watertight and should be provided with gasproof curtains.

*f. Signs.*—(1) Direction signs are as necessary in complicated trench systems common to stabilized situations as road signs in unfamiliar country. The engineers are charged with naming trenches and preparing and posting signs. A good system is to name works, sectors, and their subdivisions with the names of cities in the United States and have the position of these elements bear the same general relation to each other as these cities do.

(2) Main parallels and main approaches should bear the same names throughout their length, and approaches should be designated as IN or OUT trenches.

(3) A good size for signs is 24 by 12 inches. The letters should be large and heavy enough to be read at a distance. A white background with black letters is most effective.

(4) For night use luminous paint should be employed when available. Lighting trench signs is usually impracticable.

(5) Beacons and red lanterns shielded from enemy observation may be used on roads or main routes of approach, but generally cannot be used in the forward areas.

*g. Latrines.*—(1) Latrines should be located in offsets from trenches, usually not more than 50 yards away from and in a place convenient of access for the men who will use them. They should not be located in dugouts, except in very large ones where special provision is made for ventilation. They should not be located near points which are likely to draw fire.

(2) Accommodation both in latrine and urinal facilities should be provided for at least 4 percent of the command. If a trench system is to be occupied a considerable time, facilities should be provided for at least 8 percent of the command.

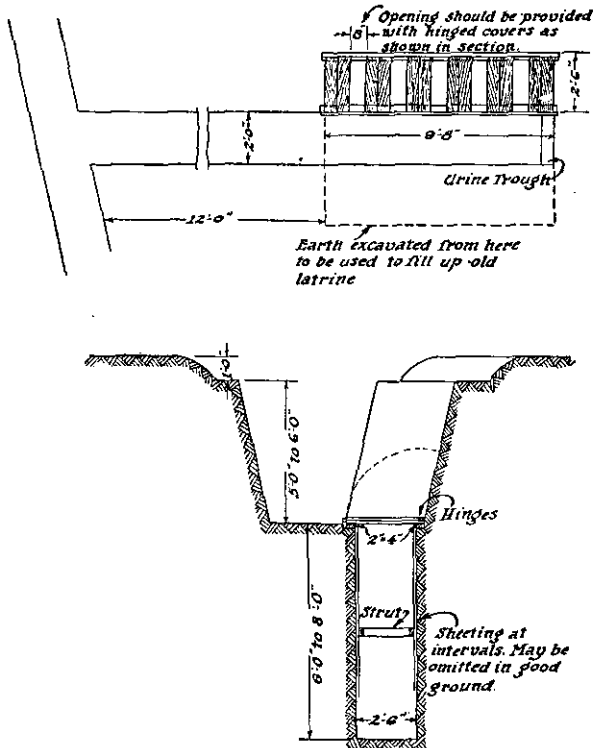

FIGURE 65.—Deep latrine, straddle type.

(3) *Types.*—(a) *Bucket.*—Any type of bucket or can provided with a seat and cover may be used. The buckets are placed in an excavation from which they can be removed easily, and a routine arrangement made for emptying them.

This system is used only where deep latrines cannot be constructed.

(b) *Deep*.—The *straddle* (fig. 65) and the *boxseat* (fig. 66) are the usual types. Pits should be dug 6 to 8 feet deep and when filled to within 2 feet of the top should be completely filled with earth and a new latrine dug.

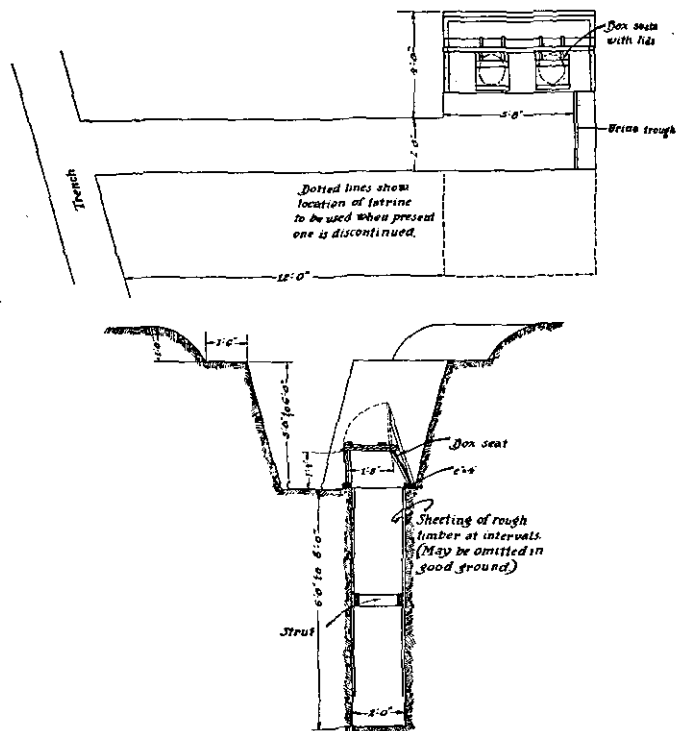

FIGURE 66.—Deep latrine, boxseat type.

(4) *Urine troughs or tubs* should be provided in every latrine; troughs may be made easily of standard corrugated-iron sheets.

*h. Ladders and steps*.—(1) *Ladders*.—(a) Ladders form the most satisfactory means of exit from trenches for the



purpose of attack. Permanent ladders 5 feet long and in sufficient numbers for patrols are ordinarily fixed to the front wall of a trench.

(b) In preparation for attack a large number of loose ladders should be placed in the parallels of departure. When the attack is about to start these may be supplemented by taking up trench boards and using them as ladders after knocking off alternate crosspieces.

(2) *Steps*.—To permit travel over surface of the ground at night, ladders, steps, or ramps should be provided along the communication trenches throughout the position. Steps

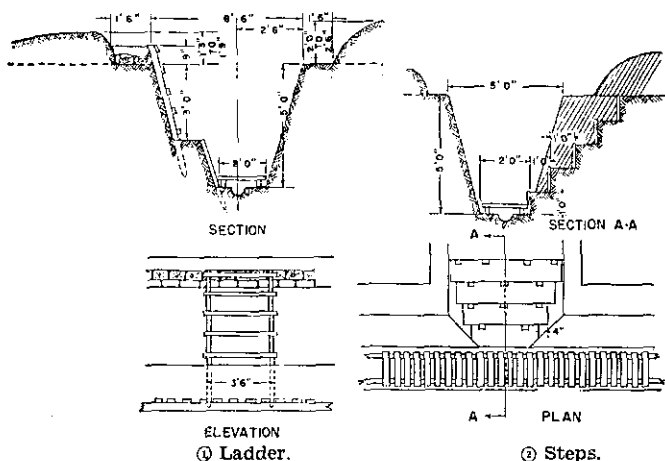

FIGURE 67.—Sortie ladder and steps.

may be cut into the earth and revetted. Figure 67 shows simple types of sortie ladders and steps.

*i. Telephone lines*.—(1) Erection, maintenance, and repair of telephone lines other than organizational wire are duties of the Signal Corps. In trenches the two methods of installing wire generally used are—

(a) Wire trenches constructed for this purpose.

(b) Installation in regular fire and communication trenches.

(2) Wire trenches vary in size from 10 inches wide by 10 inches deep to 36 inches wide by 30 inches deep, a usual size being 18 inches wide at the bottom and 30 inches deep. These trenches for stringing field telephone wire are left open. They offer considerable protection from shell fire and render wires easily accessible for repair. They have the disadvantage of offering an obstacle to friendly traffic and are easily visible to the enemy. The field wire may be fastened to cross arms on short poles or the cross arms may rest against or project into sides of the trench without poles. Instead of using cross arms the wire may be fastened to the sides of vertical poles. Field wire may be fastened directly to these supports with wire or marine but it is preferable to use insulators.

(3) When it is impracticable to construct wire trenches, field wire may be installed in fire or communication trenches. Ordinarily wire should be kept on the side of the trench nearest the enemy and from 10 to 30 inches from the bottom of the trench. The field wire may be fastened to the side of a trench by—

(a) Stiff wire staples about 12 inches long driven into side of trench.

(b) Insulators mounted on boards which are fastened to sides of trench by rods or staples.

(c) Insulators on wooden stakes driven into side of trench.

(d) Insulators on posts driven into bottom of trench close to the side.

(e) Attaching wire to revetment posts either directly or on insulators.

(4) *Lead covered cables* are laid along the bottom of specially dug trenches and the trench filled in. Such trenches about 8 feet deep effectively protect against most shell fire but involve a great deal of labor. Lead covered cables may also be laid in communication trenches from 2 to 3 feet below the bottom of the trench. As a temporary measure cables may be strung along sides of trenches.

## SECTION VI

## OBSTACLES

■ 40. CLASSIFICATION.—*a.* Obstacles are *natural* or *artificial*.

(1) Examples of *natural* obstacles are mountain ranges, streams, lakes, swamps, thick underbrush, and tropical jungle.

(2) *Artificial* obstacles are either—

(a) *Fixed*, examples being high, double-apron, and low wire entanglements, abatis, and inundations or

(b) *Portable*, examples being concertinas, chevaux-de-frise, and gooseberries.

*b.* From the tactical viewpoint obstacles are either *tactical* or *protective*.

(1) *Tactical* obstacles may be either natural or artificial, and are required to break up the enemy's attack formation and hold him in areas which are covered by intense defensive fires, particularly of automatic weapons. For this reason their location is usually determined by the defensive fires, especially the final protective line of machine guns.

(2) *Protective* obstacles are usually artificial and prevent the enemy from delivering a surprise assault from areas close to a position. They must be near enough for adequate surveillance by day or night and far enough away to prevent the enemy from lying beyond the obstacle and bombing the position with hand grenades. Thus they should be between 30 and 100 yards from the trenches. Skillful location may permit an obstacle to serve both tactical and protective missions.

*c.* Obstacles may also be classified with respect to what they are expected to stop, as against foot troops, horse cavalry, and track-laying and wheeled vehicles. Obstacles against track and wheeled vehicles are covered in FM 5-30. This section deals principally with obstacles against foot troops and horse cavalry.

■ 41. BASIS OF LOCATION, DESIGN, AND CONSTRUCTION.—*a.* Cover throughout by fire of the defense.

*b.* Protective obstacles under observation at all times.

*c.* Deny enemy ground which might offer him shelter.

*d.* Concealed by taking advantage of natural irregularities of ground and natural growth.

e. Provide for all around protection.

f. Avoid regular, geometric lay-out that discloses location of position and its elements.

g. Use belts from 4 to 10 yards wide separated by intervals of from 15 to 40 yards.

h. Barbed wire entanglements are the most nearly ideal of the artificial obstacles.

■ 42. BARBED WIRE.—*a. Materials.*—(1) Barbed wire is obtainable in various styles. The standard is the familiar two-wire type of No. 12, A. S. & W. gage wire with four-point barbs, spaced approximately 4 inches apart. The length on a commercial reel as shipped from the factory is about 420 yards, and the weight of a full reel about 100 pounds plus weight of the reel, about 5 pounds. Reels of about one-half the foregoing size are also obtainable, and are desirable. Hand bobbins are usually made up at the rear from the large size reels, contain 30 yards of wire, and weigh from 8 to 9 pounds each. They are always used when constructing entanglements.

(2) To make bobbins, secure 1-inch round or square sticks approximately  $2\frac{1}{2}$  feet long. When necessary round off the ends to facilitate handling. It is desirable to drive eight-penny or tenpenny nails through the stick about 8 inches from each end. This type of bobbin stick and an alternative type, which takes more time and material to make but is easier to handle, are shown in figure 68. Improvise trestles, pass a pick handle, piece of pipe, or other suitable article through the reel, and place in the trestle so that the wire may be unreeled from the bottom (see fig. 68). Two men work at making bobbins, one at the bobbin and one at the reel, alternating duties from time to time. The bobbin man fastens the end of the wire to one of the nails in a bobbin stick and draws the wire out over a measured distance of 30 yards. The man at the reel controls movement of the reel by hand or by braking with a stick. The bobbin man grasps the stick at the center with both hands and keeps his hands in this position while making the bobbin. Maintaining a constant strain on the wire, he moves toward the reel at the same time winding the wire on the bobbin by overhand movements so that the wire is passed alternately over and around first one end of the stick, then the other, coming to rest on the nails as shown

in figure 68. When the 30-yard length of wire, about 45 turns on the bobbin, has been wound the wire is cut and the free end marked with white rag or tape and secured. The result

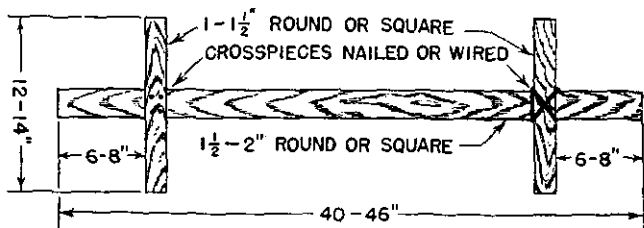

FREE END MARKED WITH WHITE TAPE

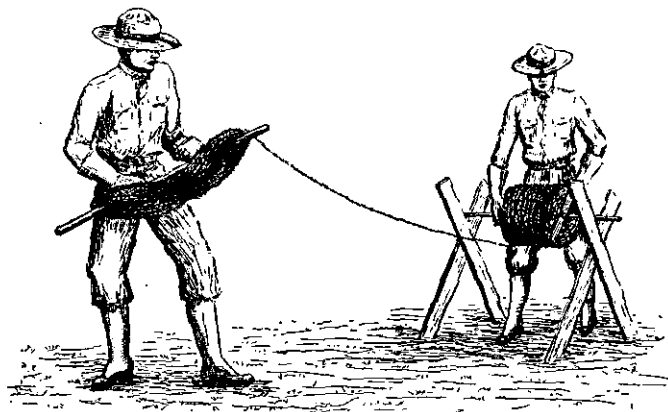

FIGURE 68.—Making bobbins.

is a compact bobbin of light weight. One man can easily carry four such bobbins, two in each hand, or six on a stick on his shoulder.

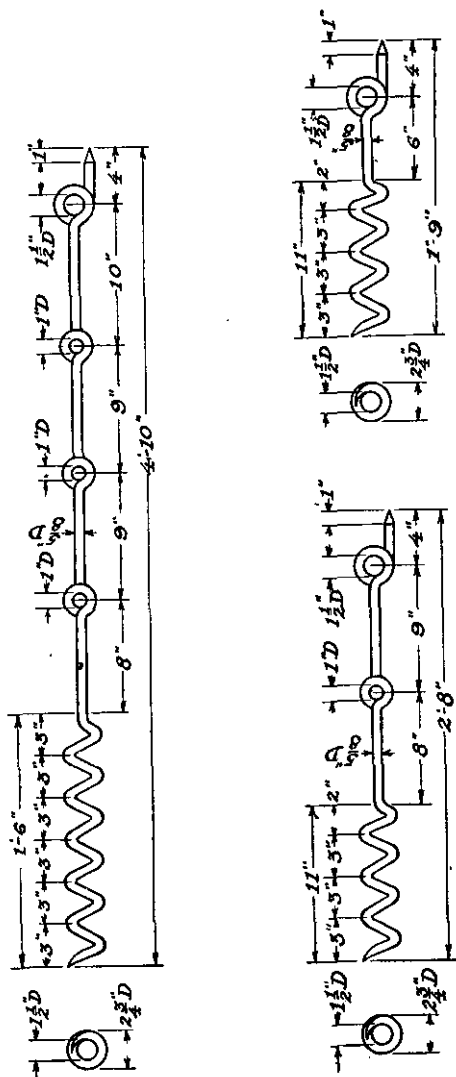

FIGURE 69.—Screw pickets.

(3) *Wooden pickets* are cut in nearby woods or are shipped from the rear. They should range in diameter from 2½ to 4 inches, and should be cut 5 feet long for the high entanglement and 2 feet 6 inches for the low type. Pickets split from a log by quartering should be avoided as they increase materially the visibility of an entanglement.

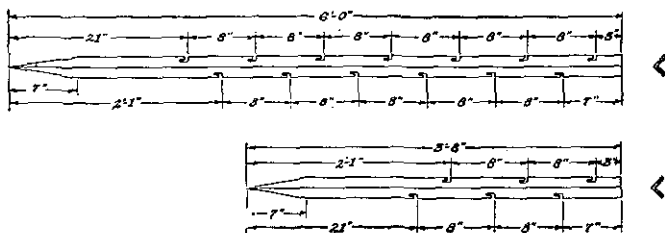

FIGURE 70.—Angle-iron pickets.

(4) Figure 69 illustrates standard types of *screw pickets*, the helix permitting them to be screwed noiselessly into the ground.

(5) Figure 70 shows standard types of angle-iron pickets.

(6) *Table of wire entanglement materials*.—The following table gives data relative to standard entanglement materials:

TABLE XV

Material	Weight	Length	Number easily carried by 1 man	Weight of man load
Wooden picket:	<i>Pounds</i>	<i>Ft. In.</i>		<i>Pounds</i>
Long, 3- to 4-inch diameter.....	12-16	5 0	3	36-48
Short, 2- to 3-inch diameter.....	4-8	2 6	8	32-48
Screw picket:				
Long.....	9	4 10	4	36
Medium.....	6	2 8	6	36
Anchor.....	4	1 9	8	32
Angle iron:				
Long.....	10	6 0	4	40
Short.....	6	3 8	6	36
Full reel wire, 420 yards, approximate.....	105	1,260	½	152.5
Bobbin, 30 yards.....	8-9	90	4-6	32-54

<sup>1</sup> Full-sized reels are carried by two men upon their shoulders by means of a picket passed through the hole in the reel.

b. *Types of entanglements.*—The following obstacles may be considered standard and methods for their construction are outlined:

- (1) High wire entanglement.
- (2) Double-apron fence.
- (3) Low wire entanglement.
- (4) Belts of barbed wire or concertinas.
- (5) Portable wire obstacles.

c. *Wire entanglement drills.*—(1) *General.*—The following remarks and precautions are applicable to all entanglement drills.

(a) The line of stakes toward the enemy for high wire and the center line for double-apron and low wire should be traced and marked in the manner described for trenches. Use of tracing tape is highly desirable for night work in presence of the enemy.

(b) The men are given numbers in the order in which they first proceed to work, each having definite, limited tasks. They start at intervals so that men doing different tasks will not be bunched, exposed to fire, or interfere with each other. One row of pickets is set by pacing. The others are placed by eye, using the paced row as a guide. The elements nearest the enemy should be placed first, and work continued to the rear.

(c) Pickets should be carried under the left arm and placed on the ground with the right hand so that end of the screw or point of the picket faces the enemy, indicating the spot at which the picket is to be erected. For carrying, all bundles of screw and iron pickets should be wrapped with a sandbag and secured in at least two places by a turn of plain wire with the ends twisted together. Enough end to this wire must always be left so that it can be untwisted by hand without pliers. Bundles of long wooden pickets should be tied together in at least two places with a plain wire. Short wooden pickets are carried best in sandbags, a suitable number in each bag. Two bags are tied together and slung over the shoulder. Screw pickets must be screwed in so that the eyes are parallel to the length of the entanglement, and the eye points in the direction from which the men are working, that is, toward the starting point. Compliance with this rule fa-



facilitates placing wires. Wooden pickets used as hold-fasts (anchors) should be driven in approximately at right angles to the stay wire to be attached to them, but screw anchorage pickets must be placed in prolongation of this stay wire.

(d) In running out barbed wire two men work together; one man walks out with the bobbin, unwinding as he goes, and the other stretches the wire and fastens it to the pickets.

(e) Men fastening the wires must always work facing the enemy.

(f) The carrying parties indicated in the drills can carry at one trip all the material required for 50 yards of entanglement. If a round trip to the dump requires more time than construction of 50 yards of obstacle, strength of the carrying party must be increased accordingly.

(2) *Fastening wire to pickets.*—(a) To fasten wire in top eye of screw picket (see fig. 71 ①); pull the fixed wire (the one leading toward the starting point) taut and slip the wire up into the eye, turn the running end up over the eye, thus threading the wire in the eye. Then take a turn with the running end over the standing end and around the picket below the eye.

(b) To fasten the wire in a lower eye of a screw picket when there is already a wire in the top eye—

1. Pull the fixed end taut and slip the wire up into the eye. Then take a bight on the running end, pass it around the picket above the eye, and take a turn with the bight on the running end (see fig. 71 ②).
2. If one eye is on the opposite side of the pickets from the others, the wire must be forced down into the eye, and the bight on the running end passed around the picket under the eye (see fig. 71 ③).

(c) The foregoing rules ((a) and (b) above) apply whichever way the wiremen are working, from right to left or left to right, and if carried out the wire will be fixed firmly in the eye and cannot slip up or down the picket. Also, if one bay is cut the wire in the bays on either side remains taut and does not slip through the eyes.

(d) Wires are fastened to wooden pickets as shown in figure 72.

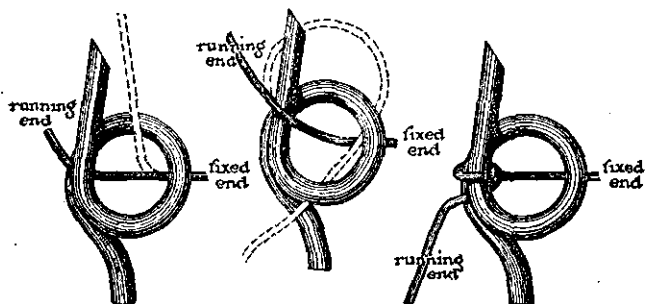

① At top of picket.

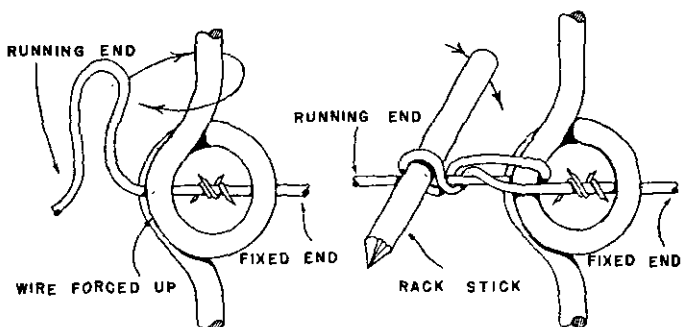

② Intermediate eye, wire underneath.

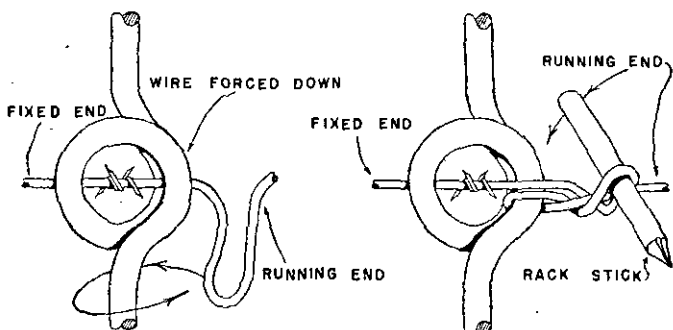

③ Intermediate eye, wire on top.

FIGURE 71.—Proper method of fastening wire to screw pickets.

(e) To fix one wire to another a short length of smooth wire may be used or the two wires may be twisted together by means of a rack stick as shown in figure 73. This is the better method and is known as "windlassing." Each member of a wiring party is equipped with a rack or windlass stick.

(3) *High wire.*—(a) This entanglement consists of a series of fences made of standard long pickets either wood, screw, or angle iron, spaced 10 feet apart. A sufficiently close approximation to the distance is 4 paces of an average

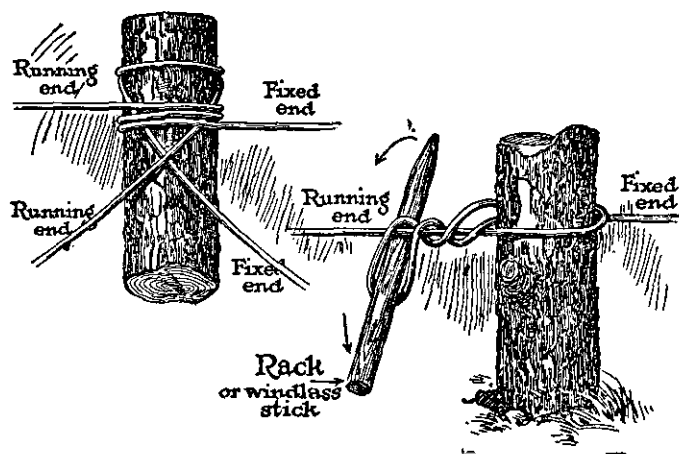

FIGURE 72.—Proper method of fastening wire to wooden pickets.

man. The spacing in depth between successive rows is the same; thus five rows of pickets give an entanglement 40 feet in depth. In each row the pickets are placed opposite the center of the intervals between pickets of the adjacent rows. This arrangement is shown in figure 74.

(b) On each fence or row of pickets there is a bottom horizontal wire about 6 inches above the ground and a top horizontal wire at or near the top of the pickets; also, in each bay there are two diagonals. This system of top and bottom horizontals and diagonals also runs in a zigzag

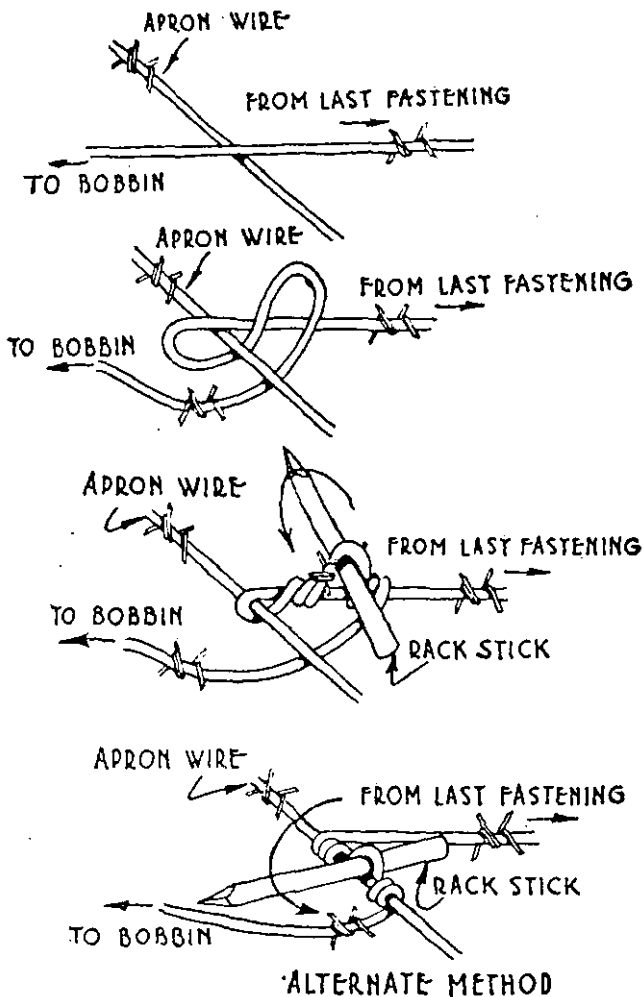

FIGURE 73.—Method of fastening two wires together by "windlassing."

direction between rows of pickets, giving a series of triangular cells. All wires are strung in the order and manner shown in figure 74.

(c) This type of entanglement may be constructed with two rows of pickets, giving a complete unit. For more important obstacles it is constructed in greater widths, five rows of pickets generally being employed and being considered a full belt. The full width of the entanglement need not be built as the first operation; two or three rows of pickets may be driven and wired across the front to be covered to develop the defensive value of the position at once. Inclined anchorage pickets may be placed opposite each picket of the outside row and at a distance of about 5 feet from the picket. Guy wires are attached to these, running to the head of the main pickets. This practice is sometimes varied by placing the anchor pickets opposite the center of intervals between main pickets and guying diagonally in both directions. At least two strands of wire should be used on each guy, preferably barbed wire as used in the entanglement itself.

(d) In case sufficient barbed wire is not available for the whole entanglement, the most efficient utilization of it would be for the top and bottom fence wires as it is these that the body encounters whether the soldier attempts to go over or under the obstacle.

(e) *Drill for erecting high wire entanglement.*

TABLE XVI.—50 yards high wire entanglement (two rows of stakes)

Materials	Wiring party	Carrying party
8 bundles (total of 32) long pickets. 32 30-yard bobbins barbed wire.	1 noncommissioned officer (carries pliers). 16 men (each carries a rack stick). 1 man, carrier.	1 noncommissioned officer. 18 men.

TABLE XVI.—50 yards high wire entanglement (two rows of stakes)

Nos.	First task	Second task	Third task
Noncommissioned officer.	Leads party to head of work.	Faces front panel and indicates location of pickets; supervises work.	
1..... 2.....	Each man carries out one bundle pickets.	Place pickets of front panel.	String bottom horizontal wire, zigzag panel.
3..... 4.....		Place pickets of rear panel.	String first diagonal wire, zigzag panel.
5..... 6.....		Screw in pickets of front panel.	String second diagonal wire, zigzag panel.
7..... 8.....		Screw in pickets rear panel.	String top horizontal wire, zigzag panel.
9..... 10.....	Each man carries out three bobbins barbed wire.	String bottom horizontal wire, front panel.	String bottom horizontal wire, rear panel.
11..... 12.....		String first diagonal wire, front panel.	String first diagonal wire, rear panel.
13..... 14.....		String second diagonal front panel.	String second diagonal wire, rear panel.
15..... 16.....		String top horizontal front panel.	String top horizontal wire, rear panel.
17.....		Carry out 5 bobbins barbed wire.	

NOTE.—Numbers 1 to 4 place pickets lightly in ground. In stringing, odd numbers run out bobbins, even numbers fix wire to pickets.

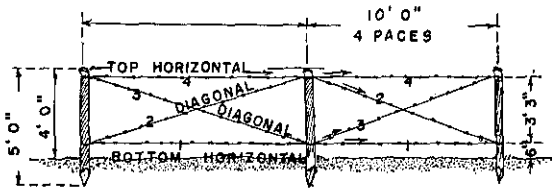
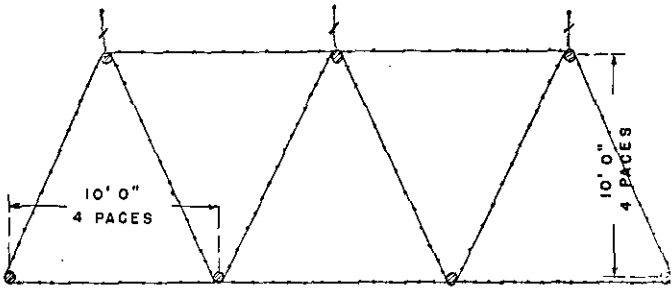

1,2,3 ETC GIVES ORDER OF STRINGING WIRE

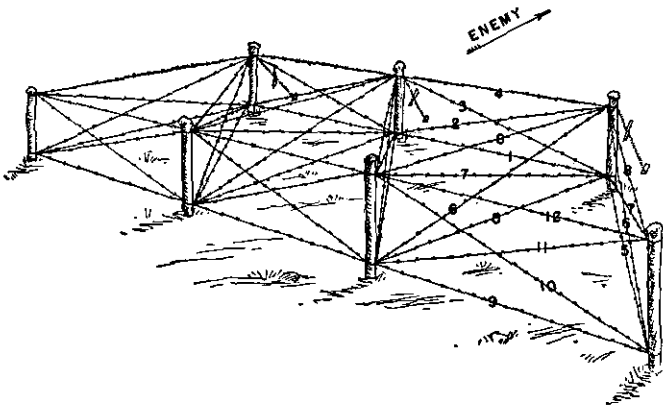

FIGURE 74.—High wire entanglement.

*Each additional row of high wire entanglement*

Material	Wiring party	Carrying party
4 bundles (total of 16) long pickets. 24 30-yard bobbins.	1 noncommissioned officer. 10 men.	1 noncommissioned officer. 12 men.

(4) *Double-apron fence.*—(a) The double-apron fence, 4- and 2-pace, consists of a central row of long pickets spaced 10 feet, or 4 paces, apart, upon which are strung four horizontal strands equally spaced from top to bottom. Parallel to and on each side of this row of pickets is placed a row of anchorage pickets to which diagonally inclined wires forming the apron are strung. The anchorage pickets are placed opposite the intervals, and 5 feet, or 2 paces, from the line of the long pickets. Each of the two sets of diagonally inclined wires carries three horizontal wires. This type of entanglement is erected with great rapidity and resists destruction by shell fire or bangalore torpedoes as well as any other pattern. For very rapid work and to develop utility of the barrier at once, the back apron is sometimes omitted. If sufficient barbed wire is not available, smooth wire may be used for the rear apron and if necessary for the diagonal wire of the front apron. Value of the entanglement lies chiefly in the front apron which should never be omitted. All wiring is done from front to rear, the diagonals in the front apron being placed first. Three horizontal wires are placed on the sloping apron and windlassed to the diagonal wires. The four horizontal wires of the central fence are next strung, following which the diagonals and apron wires of the rear apron are placed successively (see fig. 75).

(b) This entanglement is economical in labor and material and can be developed into a broad barrier by construction of successive bands. The space between bands can be filled with portable obstacles or loose wire in the form of spirals. As in the construction of the high wire type, the working parties are covered by the first elements of wire placed, and they work behind it toward their own lines.



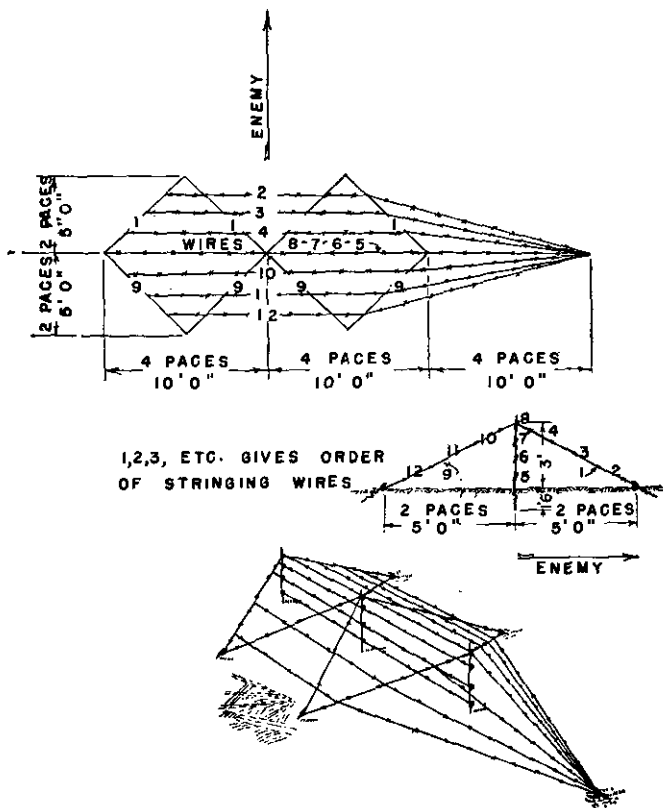

FIGURE 75.—Double-apron fence, 4- and 2-pace.

## (c) Drill for erecting double-apron fence.

TABLE XVII.—50 yards double-apron fence, 4- and 2-pace type

Material		Wiring party			Carrying party	
Nos.	First task	Second task	Third task	Fourth task	Fifth task	
	4 bundles (total of 16) long pickets.	1 noncommissioned officer (carries pliers).	1 noncommissioned officer (carries 15 men.	1 noncommissioned officer.		
	4 bundles (total of 32) anchor pickets.	9 men (carry rack sticks).				
	26 30-yard bobbins barbed wire.					
	Carries out 1 bundle long pickets. Paces off and indicates to Nos. 1, 2, and 3 location of pickets. Supervises work.					
1			Run out front diagonal wire.	Run out bottom horizontal wire of fence.	Run out rear diagonal wire.	
2	Each carries out 1 bundle long pickets.	Lay out and screw in pickets of center line.	Fasten front diagonal wire on anchor pickets.	Fasten bottom horizontal wire of fence on pickets, Nos. 2 and 3 working on alternate pickets.	Fasten rear diagonal wire on long pickets.	
3			Fasten front diagonal wire on long pickets.		Fasten rear diagonal wire on anchor pickets.	

4.-----	Lay out and screw in front anchor pickets. No. 4 places pickets at head of work.	Run out trip wire, front apron.	Run out second horizontal wire of fence.	Run out top horizontal wire, rear apron.
5.-----		Windlass trip wire to diagonal wire.	Fasten second horizontal wire of fence on pickets.	Windlass top horizontal wire to diagonal wire.
6.-----	Each carries out 1 bundle anchor pickets.	Run out second horizontal wire, front apron.	Run out third horizontal wire of fence.	Run out second horizontal wire, rear apron.
7.-----		Windlass second horizontal wire to diagonal wire.	Fasten third horizontal wire of fence on pickets.	Windlass second horizontal wire to diagonal wire.
8.-----	Carry out 26 bobbins of barbed wire.	Run out top horizontal wire, front apron.	Run out top horizontal wire of fence.	Run out trip wire rear apron.
9.-----		Windlass top horizontal wire to diagonal wire.	Fasten top horizontal wire of fence on pickets.	Windlass rear trip wire to diagonal wire.

NOTE.—Diagonal and apron wires begun and finished on end anchor pickets. Horizontal wires on fence not carried down to end anchor pickets.

(d) The double-apron fence, 6- and 3-pace (fig. 76), is exactly similar to the 4- and 2-pace type except that the distance between long pickets is 6 paces instead of 4 and the anchor pickets are placed 3 paces instead of 2 from the center line of the obstacle. This results in a wider obstacle but one that is probably not as strong as the 4- and 2-pace type. As may be seen from table XXI, the number and weight of long and anchor pickets is about 30 percent less for the 6- and 3-pace type and there is no increase in amount of wire required. The wiring party is reduced by one man and hence the man-hours by  $\frac{1}{2}$  man-hour for 50 yards of entanglement. Also drill for erection of the 6- and 3-pace fence is simpler. This reduction in amount and weight of material and in man-hours required is a very important consideration in many situations. However the 6- and 3-pace fence has not had the benefit of actual war experience as has the 4- and 2-pace.

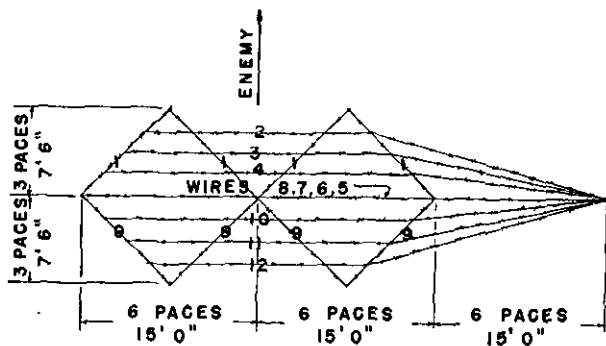

1,2,3 ETC. GIVES ORDER  
OF STRINGING WIRES

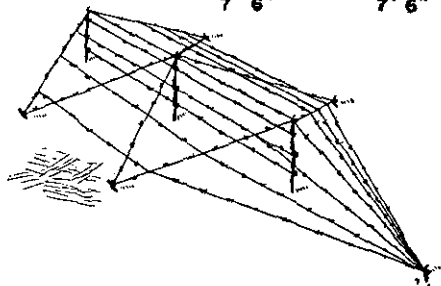
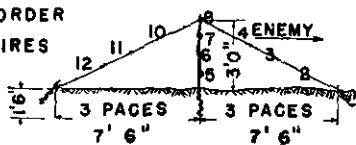

FIGURE 76.—Double-apron fence, 6- and 3-pace.

(e) *Drill for erecting double-apron fence.*  
**TABLE XVIII.—50 yards double-apron fence, 6- and 3-pace type**

Material		Wiring party			Carrying party
3 bundles (total of 11) long pickets,	1 noncommissioned officer (carries pliers).				1 noncommissioned officer.
4 bundles (total of 22) anchor pickets, 26 30-yard bobbins barbed wire.	8 men (carry rack sticks).				15 men.
Nos.	First task	Second task	Third task	Fourth task	Fifth task
Noncommissioned officer	Carries and lays out 1 bundle long pickets. Paces off and indicates to Nos. 1 and 2 location of pickets. Supervises work				
1.....	Each carries out 1 bundle long pickets.	Lay out and screw in pickets of center line.	Run out and fasten front diagonal wire.	Run out and fasten bottom horizontal wire of fence.	Run out and fasten rear diagonal wire.
2.....					
3.....	Each carries out 1 bundle anchor pickets.	Lay out and screw in front anchor pickets. No. 3 places pickets at head of work.	Run out and fasten front trip wire.	Run out and fasten second horizontal wire of fence.	Run out and fasten top horizontal wire, rear apron.
4.....					

5.....	Each carries out 1 bundle anchor pickets.	Lay out and screw in rear anchor pickets. No. 6 places pickets at end of work.	Run out and fasten second horizontal wire, front apron.	Run out and fasten third horizontal wire of fence.	Run out and fasten second horizontal wire, rear apron.
6.....			Run out and fasten top horizontal wire, front apron.	Run out and fasten top horizontal wire of fence.	Run out and fasten trip wire, rear apron.
7.....					
8.....		Carry out 26 hobbins of wire.....			

NOTE.—Diagonal and apron wires begun and finished on end anchor pickets. Horizontal wires on fence not carried down to end anchor pickets.

(5) *Low wire.*—(a) The low entanglement (fig. 77) consists of a double-apron with the fence, except the top wire, omitted. Medium pickets are used, preferably of the screw type, spacing and arrangement being the same as for the double-apron fence. The wire forming the inclined diagonals toward the enemy is strung first. Across the diagonals are then laid the three horizontal wires in the order indicated in figure 77. A horizontal wire is next strung along the tops of the pickets. The wire forming the rear diagonals is then strung, followed by the three horizontal wires which it supports in the order indicated in the figure. Horizontal wires are windlassed to inclined diagonals at points of contact.

(b) The chief advantages of the low wire type are its economy of material and labor and its low visibility with respect both to direct and terrestrial observation and to aerial photography. It is preferably built in long grass where it becomes almost entirely invisible. Its chief disadvantage is the obvious one that a man with reasonable ability can pick his way through it without much trouble. As a surprise entanglement it is unquestionably effective.

(c) Low wire entanglement of either 6- and 3-pace or 4- and 2-pace types may be constructed. Advantages and disadvantages of the two types of double-apron wire (see (4) (d) above) apply to low wire entanglements. Figure 77 and table XIX give details and drill for the 6- and 3-pace type. The 4- and 2-pace type is exactly similar except for substitution of 4 and 2 paces for the 6 and 3 paces in laying out the wire and for the changes noted in the drill table XIX.



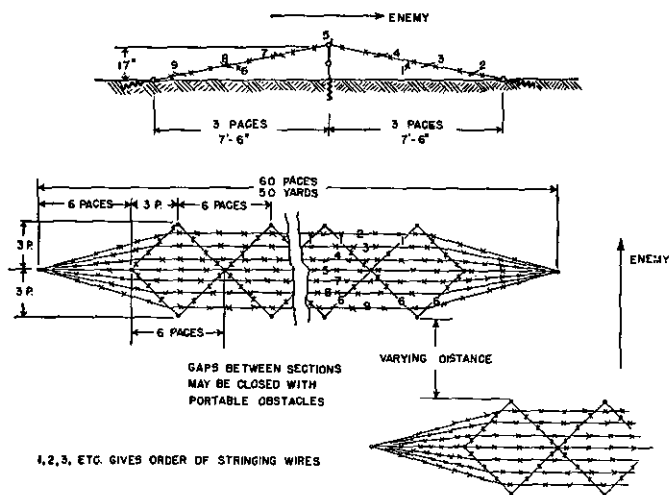

FIGURE 77.—Low wire entanglement, 6- and 3-pace.

(d) Drill for erecting low wire entanglement.

TABLE XIX.—50 yards low wire entanglement, 6- and 3-pace\*

Material	Wiring party	Carrying party
2 bundles medium pickets (1 of 6, 1 of 5 each). <sup>1</sup>	1 noncommissioned officer (carries pliers).	1 noncommissioned officer.
4 bundles (total of 22) anchor pickets. <sup>2</sup>	6 men (carry rack sticks).	13 men.
20 30-yard bobbins barbed wire.		

\*Changes in drill for 4- and 2-pace:

<sup>1</sup> 3 bundles medium pickets (1 of 6, 2 of 5 each).

<sup>2</sup> 4 bundles (32) anchor pickets.

TABLE XIX.—50 yards low wire entanglement, 6- and 3-pace\*  
—Continued.

Nos.	First task	Second task	Third task	Fourth task	Fifth task	Sixth task
Noncommissioned officer <sup>3</sup> paces off and indicates to Nos. 1 and 2 location for their pickets. Supervises work.						
1	Carries out 1 bundle medium pickets.	Carries out 1 bundle medium pickets	Lay out and screw in center line of pickets	String and fasten front diagonal wire	String and windlass top horizontal wire front apron	String and windlass top horizontal wire rear apron
2	Carries out 1 bundle anchor pickets	Carries out 1 bundle anchor pickets				
3	Carries out 1 bundle anchor pickets	Carries out 1 bundle anchor pickets	Lay out and screw in outer anchor pickets	String and windlass trip wire, front apron	String and fasten horizontal wire, center line	String and windlass second horizontal wire, rear apron
4	Carries out 4 bobbins barbed wire	Carries out 4 bobbins barbed wire				
5	Carries out 4 bobbins barbed wire	Carries out 2 bobbins barbed wire	Lay out and screw in inner anchor pickets	String and windlass second horizontal wire, front apron	String and fasten rear diagonal wire	String and windlass trip wire, rear apron
6	Carries out 4 bobbins barbed wire	Carries out 2 bobbins barbed wire				

<sup>3</sup> Carries out 1 bundle medium pickets. Paces off and indicates to Nos. 1 and 2 location for their pickets. Lays out own pickets. Supervises work.

NOTE.—No. 3 places picket at head of work. No. 5 places anchor picket at foot of work. Diagonal wire of rear apron and horizontal wire on center line of pickets are not carried down to end anchor pickets. Low-wire entanglements are slow to erect at night, owing to the difficulty of seeing the pickets.

(6) *Four-strand fence*.—Under press of time or shortage of men or materials, a less effective type of entanglement can be erected. For such purpose the four-strand fence may be used. This is the central fence of the double-apron fence entanglement (see fig. 80). This can later be elaborated into the double-apron fence by addition of the aprons. The four-strand fence can be erected by an 8-man wiring party and an 8-man carrying party at the rate of 50 yards in 15 minutes, day work, with a carry of not more than 400 yards. For longer or shorter carries, the carrying party should be increased or decreased proportionately. This type of wire is usually employed as the protective wire around the defense areas.

(7) *Barbed wire concertina*.—(a) This type of obstacle is prepared in advance and in the field needs only to be opened out, supported on a wire strung between posts, and stapled to the ground.

(b) Draw on the ground a circle 4 feet in diameter. Place nine posts, an odd number is essential, equally distant, approximately 17 inches apart around this circle and drive them, leaving a height of 5 feet above ground. Angle-iron pickets are much easier to work with than wooden ones. One 100-yard coil of barbed wire is required per concertina, with short lengths of plain wire for fastening. The unit party is three men. No. 1 works inside the framework, Nos. 2 and 3 run out the coil, No. 2 helping No. 1 if necessary (see fig. 78).

(c) Average time per concertina is 20 minutes. Take two complete turns around the nine posts with No. 10 plain wire or four turns with No. 16 wire, and bind these turns together at each interval between posts so as to form a secure end ring for pulling the concertina out. Fasten the end of the barbed wire to the plain wire and take 24 turns with it around the posts in a spiral form, binding two consecutive turns together at every other interval, using No. 16 plain wire for binders. Make two turns with plain wire and make fast. It assists to have a nonagonal-shaped framework to fit inside the top of the pickets so as to keep them properly spread out. It is easily removed when the concertina is finished.

(d) The easiest method of carrying is to wire a slat to each face of the closed roll, the slats parallel to each other. The points 90° from the slat fastenings are then lightly tied with tape. The concertina can easily be carried by two men, or with reasonable ease by one man if in the open.

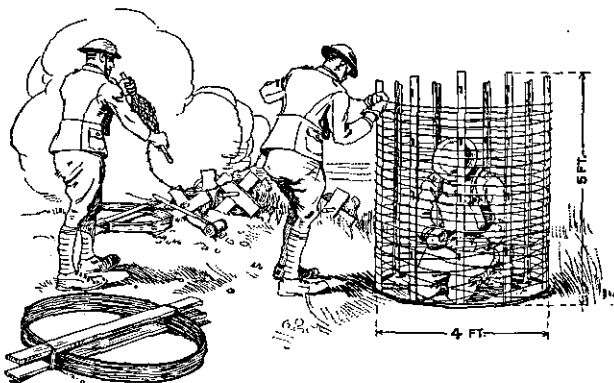

① Element collapsed and prepared for carrying.

② Method of making concertina element with either plain or barbed wire.

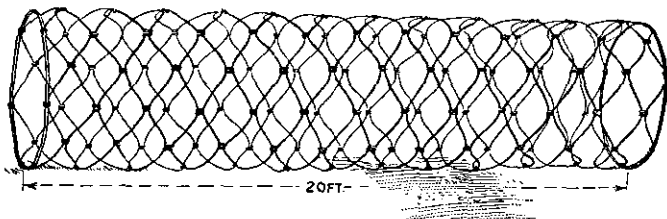

③ Concertina extended.

FIGURE 78.—Concertina.

(8) *Concertina*.—(a) Concertinas open out to a length of about 20 feet and are formed into an entanglement by tying end to end. The elements are supported between posts spaced 20 feet apart and carrying a taut top horizontal wire to which the elements are secured. Each coil should also be stapled in at least three places to the ground. The entanglement

may be thickened in depth as desired by adding successive lines. Figure 79 shows the manner in which concertina elements are arranged to form an entanglement.

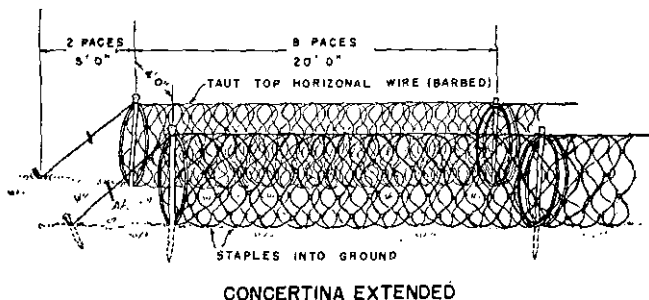

FIGURE 79.—Double-belt concertina entanglement.

(b) The entanglement has the advantages of low visibility, rapidity and ease of construction once the elements are prepared, and difficulty of destruction by artillery owing to its strength and resiliency. Being stapled to the ground it is difficult to pass, and in double lines with a top horizontal wire it forms an exceedingly efficient barrier.

(c) *Drill for erecting concertina entanglement.*

TABLE XX.—50 yards double-belt concertina

Materials	Wiring party	Carrying party
4 bundles (total of 16) long pickets.	1 noncommissioned officer (carries pliers).	1 noncommissioned officer.
4 anchor pickets.....	10 men (Nos. 1 and 2 each carry 12 pieces plain wire;	20 men.
14 coils concertina.	9 and 10 each carry 15 staples; all carry rack sticks).	
2 50-yard coils barbed wire.		
30 wire staples.		
24 8-inch pieces No. 16 plain wire.		

TABLE XX.—50-yards double-belt concertina—Continued

Nos.	First task	Second task	Third task	Fourth task	Fifth task
Noncommissioned officer carries out 4 anchor pickets. Paces off distances and locates pickets. Supervises work.					
1			Open out and place in front line of pickets 1 concertina.	Wire coils together in both belts, No. 1 working on enemy side, No. 2 opposite.	
2					
3	Carry out 4 long pickets each.	Each lays out and screws in 4 long pickets.	Open out and place in front line of pickets 1 concertina.	Open out and place in second line of pickets 1 concertina.	Run horizontal wire along top of pickets, first row.
4					Fasten wire to pickets.
5	Carries out 1 concertina and cuts tape.	Lays out and screws in 4 anchor pickets.	Open out and place in front line of pickets 2 concertinas	Open out and place in second line of pickets 2 concertinas.	Windlass coils to wires at 3 points between each 2 pickets.
6					Run horizontal wire along top of pickets, second row.
7		Carry out 1 concertina coil and cut the tapes.	Open out and place in front line of pickets 2 concertinas.	Open out and place in second line of pickets 2 concertinas.	Fasten wire to pickets.
8	Carry out 2 concertinas and cut tie tapes.				Windlass coils to wire at 3 points between each 2 pickets.

TABLE XX.—50-yards double-belt concertina—Continued

Nos.	First task	Second task	Third task	Fourth task	Fifth task
9		Carry out 1 coil barbed wire.	Open out and place in front line of pickets 1 concertina.	Open out and place in second line of pickets 2 concertinas.	Staple down both belts.
10					

NOTE.—Nos. 6, 7, 8, 9, and 10 place coils in intervals between pickets in tasks Nos. 1 and 2.

(9) Table XXI, below, is a summary of material and labor required for 1,000 yards of various single-belt entanglements.

TABLE XXI.—Summary of material and labor required for 1,000 yards of single-belt entanglement

Type of entanglement	Pickets			Barbed wire			Plain wire		Staples made of $\frac{3}{8}$ -inch round rods	Man-hours for 50 yards of entanglement <sup>1</sup>	Weight of material (pickets and wire) per linear yard of entanglement
	Long	Medium	Anchor	420-yard reels	30-yard hobbins	On reels	No. 10	No. 16			
High wire.....	640	---	<sup>2</sup> 320	<sup>3</sup> 46	640	<sup>4</sup> 4,830	Lbs.	Lbs.	---	<sup>5</sup> 9	12
Double apron:											
4- and 2-pace.....	320	---	640	37	520	3,885	---	---	---	<sup>5</sup> 5	10
6- and 3-pace.....	220	---	440	37	520	3,885	---	---	---	<sup>5</sup> 4½	8
Low wire.....	---	220	440	29	400	3,045	---	---	---	<sup>5</sup> 3½	6.25
Concertina (2 cylinders side by side).....	302	---	---	75	---	7,875	700	90	600	<sup>5</sup> 3	12
Four-strand wire fence (protective wire around defense areas).....	300	---	---	11	154	1,135	---	---	---	<sup>5</sup> 2	4

<sup>1</sup> Specially skilled crews of picked men undisturbed have erected entanglements in less than  $\frac{1}{4}$  of times stated in this column.

<sup>2</sup> For front anchorage if used.

<sup>3</sup> Plus 3 if front anchorages are used.

<sup>4</sup> Plus 315 if front anchorages are used.

<sup>5</sup> Erection of entanglement only; does not include making hobbins or carrying party. Man-hours for carrying party varies, depending on distance and rate of carrying.

<sup>6</sup> Erection of fence only. Does not include making of cylinders or carrying party.

(10) *Spider wire*.—Figure 80 shows a form of entanglement using four-strand fences identical in design to the central portion of the double-apron fence. Obviously they can be developed into single- or double-apron fences when desired. This open irregular crisscross grouping of fences is known as spider wire entanglement. It is very useful for wiring in defense areas. The fences using wooden or angle-iron pickets can be made up in portable lengths rolled up,

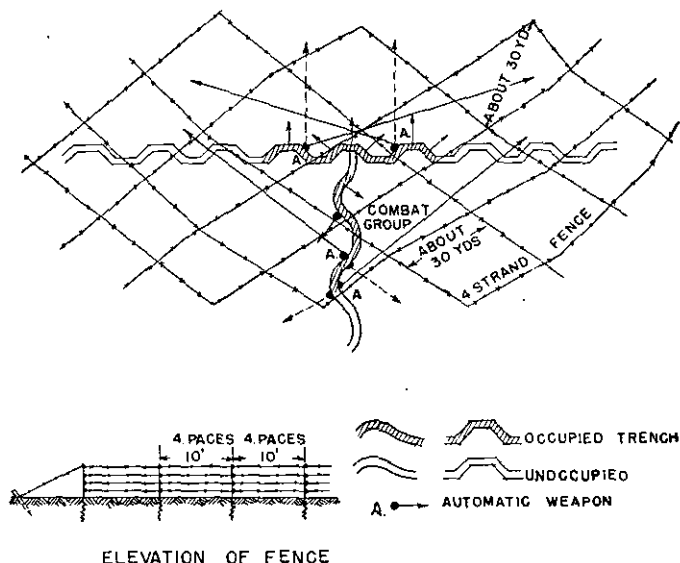

FIGURE 80.—Spider wire entanglement showing use of four-strand fences as obstacles around defense area without disclosing occupied portions of trenches.

carried to front positions, and there quickly set up by driving the pickets into the ground as the fence is unrolled.

*d. Estimating quantity of entanglement.*—(1) To estimate properly tonnage of material (pickets, wire, etc.) for a defensive position, it is necessary to know approximately how much material is required to cover a battalion area with a reasonable amount of wire obstacle. The weight of pro-



tective wire required is approximately the same as the tactical wire (see par. 40b). Tactical wire (double-apron fence) weighs 10 pounds per linear yard, and protective wire (four-strand fence) weighs 4 pounds per linear yard of entanglement. Therefore  $10/4=2\frac{1}{2}$  times as much wire in linear yards needed for protective wire as for tactical wire. Experience shows that in the average case the number of linear yards of tactical obstacle needed is approximately  $1\frac{1}{4}$  times the frontage in yards. Hence for protective wire the number of linear yards of obstacle needed is  $1\frac{1}{4}\times 2\frac{1}{2}=3\frac{1}{8}$  times the frontage.

(2) Considering the above figures, for a battalion holding a front of 1,600 yards the length of tactical obstacle will be  $1\frac{1}{4}\times 1,600=2,000$  yards, and the length of protective obstacle will be  $3\frac{1}{8}\times 1,600=5,000$  yards, a total of 7,000 yards of entanglement. The total weight of materials (pickets, wire, etc.) for one battalion area will be  $(2,000\times 10)+(5,000\times 4)$  equals 40,000 pounds or 20 tons. As the division may organize six battalion areas at the same time, we see that 120 tons will be required per division. Most of the wiring material will have to be brought up from engineer depots in the rear. Early requisition is essential to have the materials on hand when needed.

*e. Erection of wire in large quantities.*—In erection of wire in large quantities it is well to organize the erection crew into parties giving one job only to a party. As an example, in the double-apron entanglement 3 picket and 12 wiring parties might be organized to erect a large quantity of entanglement. The parties move out successively, each party keeping two bays behind the preceding party. The 3 picket parties move out first and each party erects a row of pickets. The wiring parties move out next, each party stringing one wire, the first wiring party stringing number one wire, the second, number two wire, etc., as shown in figure 75.

*f. Spirals of loose wire.*—(1) Wire entanglements of any of the types described may be thickened as desired by casting in strands of loose refractory wire. This work is greatly facilitated if the wire is previously coiled into spirals.

(2) To do this, form a diamond with axes of 3 feet and  $1\frac{1}{2}$  feet by driving 3-foot posts at the four corners. Then wind 75

yards of barbed wire around this framework from the bottom, gradually working up the stakes in a spiral. Finally take the spiral off the stakes and tie it together in four places with tape. It then can be carried easily to place where it is to be used. If spirals are needed in large quantities a winch may be improvised and used to advantage.

*g. Gaps in wire.*—(1) It is necessary that openings in obstacles about a defensive position exist at frequent intervals to permit passage of our own patrols, working parties, and assault columns. These gaps are generally formed by cutting zigzag passages through the wire after its construction is completed. By echeloning gaps in successive belts, it is possible to render them invisible to direct observation. In the case of operations involving a general advance it is necessary to cut many such passages in the wire, but these are prepared the night preceding the attack so that the preparations may not be observed by enemy observers. In order to deny passage through gaps to the enemy, the openings are normally closed by portable obstacles which can be removed readily for passage of friendly troops.

(2) Enemy entanglements may be breached by artillery concentrations, by tanks, by specially trained men using wire cutters or by heavy charges of high explosives extending continuously through the belt to be breached (see FM 5-25).

*h. Knife rest or cheval-de-frise.*—The knife rest consists of a framework of wood or iron upon which is strung barbed wire. It is sometimes called a cheval-de-frise. The framework, if the iron type, may be made collapsible and hence easier to transport, as well as being more difficult to see and stronger than the wooden type. In shape, the framework of the knife rest is of the same appearance as a common sawbuck. Figure 81 shows its construction. Chevaux-de-frise (plural of cheval-de-frise) are frequently used to stop temporary gaps in entanglements, to barricade trenches leading toward the enemy, to barricade roads and streets, and may be used as an underwater obstacle in beach defense.

*i. Gooseberry and hedgehog.*—(1) The *gooseberry* consists of barbed wire balls connected by spirals of the same material. It is used principally to block trenches. For this purpose the balls should be made with a diameter slightly greater

than the width of the trench in order that when jammed into place they will be more difficult to remove. They may also be used to make emergency repairs to existing obstacles (see fig. 82).

(2) The *hedgehog* is used in the same way as the gooseberry. The nature and manner of construction of this obstacle are shown in figure 83.

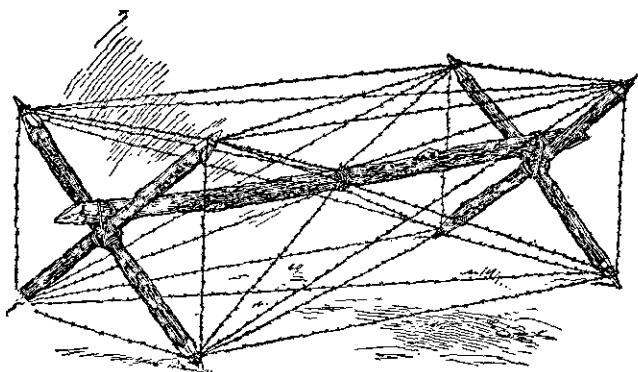

ⓐ With wire.

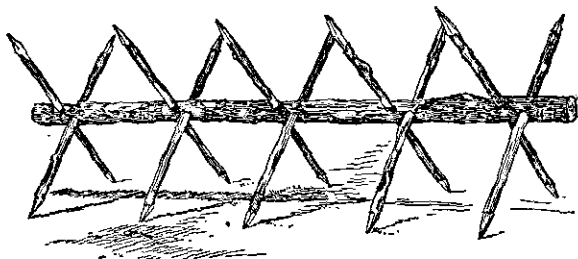

ⓑ Without wire.

FIGURE 81.—Knife rest or cheval-de-frise.

■ 43. ABATIS.—*a. Dead.*—Dead abatis is made by felling trees toward the enemy and placing them so closely together that the branches form a barrier against an advance. Difficulty of passage is increased by addition of barbed wire interlaced in branches of the trees. Wire lacing also makes removal of

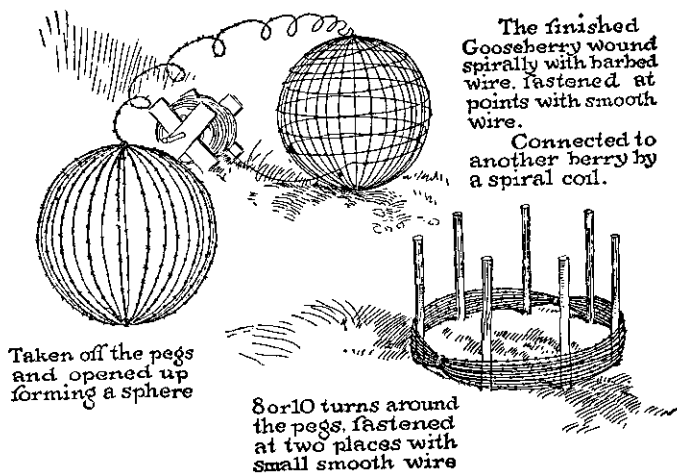

FIGURE 82.—Gooseberry.

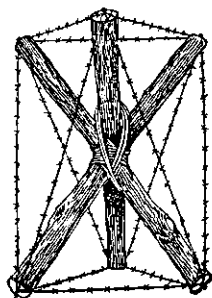

FIGURE 83.—Hedgehog.

the barrier more difficult. This type of barrier is highly efficient as a rapid means of blocking a road lined with trees. In the case of a road between two rows of trees, the trees on both sides are so felled that their tops interlock, making the barrier as dense as possible. Trees are preferably only partially cut through when felled so that their removal may be more difficult. Dead abatis has the disadvantages of being conspicuous and inflammable when dry. For these reasons it is often worth while to go to the greater labor of building live abatis for defenses in a wood.

*b. Live.*—(1) In the organization of woods where the growth is suitable, it is possible to form a barrier by bending down, interlacing, and tying the easily bent saplings and lower branches of adjacent trees in such a way that the obstacle is invisible to both ground and air observers (see fig. 84). This type of barrier is usually constructed in extended depth and is practically impassable to advancing Infantry unless circumstances are such that trench knives or axes can be used.

(2) It is sometimes the practice in connection with use of live abatis to augment its impassability by addition of a number of plain or barbed wires strung from sapling to sapling or tree to tree. Use of pickets in this situation should be avoided as they increase visibility of the barrier.

(3) In the organization of fairly dense woods abatis is not always continuous; gaps are left at points which would naturally be the avenue of approach of advancing elements. These lanes of access are directed toward lines of supplementary barriers of double-apron or high wire entanglement, there being definite lanes cut through the woods along the enemy side of these barriers, and bounded by them and the abatis. These lanes are under fire from well-placed flanking weapons and are under good observation. The object of this type of organization is to herd the enemy into zones from which he cannot easily find an exit and which are swept by fire of automatic weapons.

(4) Lanes should not be too wide as they then become visible from the air. It is possible in fairly dense woods to clear lanes 6 to 20 feet wide and to bring together the branches overhead, thus concealing their position.

■ 44. INUNDATIONS.—Inundations form serious obstacles to the attacker. They also may seriously limit counterattacks and this must be kept in mind before deciding to create inundations. They are created by building dams at suitable points. An extensive survey is frequently a necessary pre-



ⓐ Dead abatis protecting hasty trench in woods.



ⓑ Dead abatis blocking road with live abatis on its flank.

FIGURE 84.—Abatis.

liminary step to determine the area and depth to be inundated and height and best location of the dam. However, these data can often be obtained from civil officials and agencies in the vicinity. In a stream with a firm bottom it requires at least 4 feet of water to be a serious obstacle

to infantry and 6 feet as a minimum should be sought. If the bottom is soft or if the inundation is combined with other obstacles, a lesser depth suffices. Barbed wire entanglements prepared in advance, trees cut 1 to 2 feet below water level, and post or rail obstacles are examples which when inundated form most formidable obstacles. Inundations are more difficult to cross when ditches are cut chequerwise through the ground to be inundated and deep pits dug before damming up the stream. Use of explosives for this purpose is discussed in paragraph 54, FM 5-25. Inundations are very effective obstacles against tanks or any form of vehicle.

■ 45. UNDERWATER.—*a.* Underwater obstacles will be extensively used in beach defense against landing operations and in river line defense against river-crossing operations. The objects of beach and river line defense can be accomplished best by defeat of attacking forces before they succeed in placing any men on the beach or shore. Normally, defense of a beach or shore against an attempted landing in force is provided by an organized infantry defense supported by artillery and all auxiliary arms. This defense alone however with all its fire power and land obstacles may not prevent enemy landings, especially at night or under heavy fog or smoke screens, unless obstacles are placed out beyond the water's edge. This work is normally carried out by engineer troops and if not completely done by engineer troops the engineers should be called on for technical advice and assistance in any beach or river line defense.

*b.* Obstacles in beach and riverline defense will consist of any and all means available to delay the enemy's advance to the shore, break up the orderly, methodical procedure of his landing operation, and hold him in the most adverse conditions under the maximum developed fire of the defense. These obstacles may include any or all of the following belts of—

(1) Small, sensitive contact mines in deep water but close enough to the shore to be under protection of the shore defense.

(2) Wire entanglement and other suitable obstacles under the water to interfere with movement of enemy after disem-

barking from landing boats or to interfere with movement of landing boats.

(3) Wire on shore arranged to delay the enemy and hold him under flanking fires of the defense.

c. (1) In general, the character of beaches and river lines suitable for landings may be divided into two classes, those where the bottom drops away rapidly from the water's edge, and those having a gradually sloping bottom for a greater or lesser distance from the edge. Each type has its advantages and disadvantages for the defense. The steep slope prevents disembarkation until boats reach the beach, but it renders placing underwater obstacles more difficult. The gentle slope facilitates placing obstacles, but it also allows the attacking troops to disembark while still afloat.

(2) For those beaches and riverlines of the first type (steeply sloping bottom) provision should be made for stopping the landing boats and barges before they reach the shore. For this purpose the defense may utilize small, sensitive, contact mines anchored so as to be just below surface of the water; heavy logs anchored or tied to shore as floating booms either on the surface or just below the surface; and heavy cables or chains stretched between pilings. In all these methods the ideal solution would be to have all obstacles out of sight just below the surface, but a compromise must be made with the amount of tide variation, and/or variation due to flood conditions encountered. At the periods of highest water level the obstructions should be near enough to the surface to prevent the free passage of landing boats and barges. This means that at low-water levels the obstructions may be in sight on surface of the water. However whenever possible provision should be made for adjusting obstacles such as log booms, cables, and chains to take care of fluctuations in the water level.

(3) For beaches and river lines of the second type (gradually sloping bottom) the defense must not only guard against the boats reaching the beach, but must endeavor to stop them before they reach such depths that the personnel can debark and wade ashore, and once wading has begun to render it as difficult as possible. However, in addition to the obstacles mentioned above, the shallow depth can be covered thor-



oughly by underwater wire entanglements of all kinds anchored or securely fastened to the bottom.

*d.* At certain places where water level variation is great, the situation shown in figure 85 may present itself. In this figure, the water level variation is assumed to be about 5 feet. Conceding that personnel can debark in 4 to 5 feet of water and wade ashore, it is necessary to provide for two possible stages of debarkation (at high and low water) and construct sufficient bands of obstacles to hold up landing at all stages. The figure shows a gradually sloping beach; a sharper slope would decrease the amount of entanglement while a lesser slope might increase the number of bands. No definite rule can be laid down.

*e.* (1) In figure 85, the obstacles shown at A and B can be constructed during periods of low water. They may consist

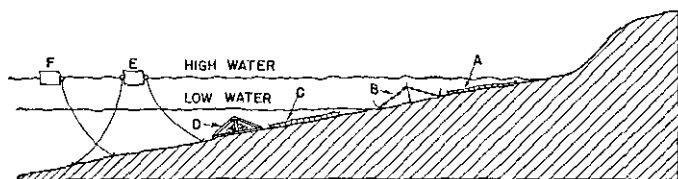

FIGURE 85.—Underwater obstacles.

of any of the standard types of entanglements and obstacles but must be anchored more securely. Where heavy surf is encountered railroad rail sharpened and driven into the beach is recommended for anchoring.

(2) The obstacles shown at C and D must be constructed on shore and then sunk in position. They may be either chevaux-de-frise made with angle-iron pickets, concertinas or any of the various barbed wire obstacles securely anchored or picketed to the bottom, or a construction similar to the low-wire entanglement. For the latter, a raft-like structure similar to the lobster pot shown in figure 86 is built, in order to provide a means of weighting it down when it is submerged. All the elements in such a belt or band of obstacles must be securely anchored in position. Heavy anchors and sharpened railroad rail driven into the bottom are recom-

mended for this purpose but various expedients will have to be adapted in the field to meet conditions.

(3) The heavy booms, cables, or chains shown at E and F (see fig. 85) tend to protect the entire installation. If booms are used it will be necessary to anchor them from two directions in order to avoid the possibility of their drifting over and damaging the wire entanglements at low water. Barbed wire may be used in connection with the booms, cables, or chains by stringing barbed wire obstacles on and between them.

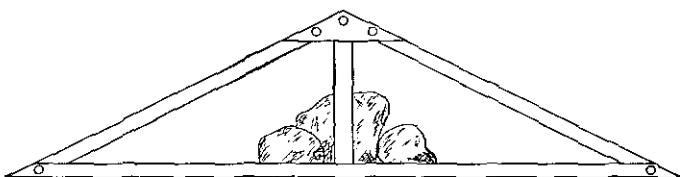
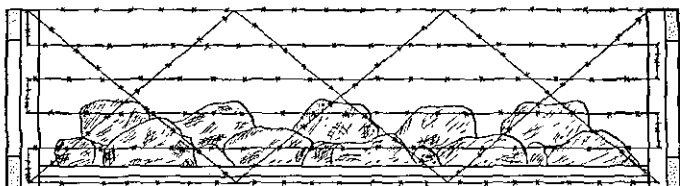

FIGURE 86.—Lobster pot obstacle.

*f.* Underwater wire entanglements will require more wire and much more secure anchorages than those not constructed under water. This is to prevent strong surfs or currents from carrying the entanglements away and so that the effect of enemy bombardment will be to tear the entanglements into nests of refractory wire rather than clearing passageways.

*g.* Spaces must be left between anchored entanglements so that enemy dragging operations will not clear a large area at one time and also to provide channels for passage of friendly small boats for repair purposes. Concertinas will

be found useful for such repair work. When desired, spaces between anchored entanglements can be closed effectively by heavily weighted spirals of refractory wire.

*h.* Other expedients that might be employed in beach or riverline defense are—

(1) Where shoreline is heavily wooded, fell trees into the water's edge forming a thick impenetrable tangle (water abatis).

(2) Spread gasoline or oil on the water and ignite it. This may be done in the case of rivers by dumping the gasoline or oil on the water above the landing spot to be defended or releasing barges or boats with drums of gasoline aboard, setting them afire and depending on them exploding among the attackers' landing boats.

(3) Boats containing charges of TNT with time fuse may be released upstream and allowed to float downstream so timed as to explode among the attackers' landing boats. If drums of gasoline are also placed aboard such boats, a water surface fire will result.

(4) Sunken hulks, floating mines, piles, nets, booms, chains, and demolished locks and bridges might be used in various situations.

■ 46. TANK.—For treatment of subject of tank, mechanized, and motorized obstacles see FM 5-30.

■ 47. SUMMARY.—Maximum use should always be taken of any natural obstacles which can be employed in the defense plan. In some instances it may even be advisable to adjust the entire plan of defense in order to take full advantage of an effective natural obstacle. Barbed wire is the most effective artificial obstacle (per ton of material) against personnel on foot or horseback. Of the various types of barbed wire obstacles, the double-apron fence is the most effective, pound for pound, and can be erected quickly. It is the standard tactical obstacle for use in organization of the ground.

## SECTION VII

## EMPLACEMENTS

■ 48. INFANTRY WEAPONS.—*a. Necessity for protection.*—Because of their relatively short ranges and advanced positions in the combat zone, infantry weapons, including the machine gun, 37-mm antitank gun, 60-mm and 81-mm mortars, will often require emplacements for protection of the gun and crew. Heavy shellproof emplacements greatly increase effectiveness of these weapons, but because of the great amount of time and labor involved in their construction they seldom will be found except in highly organized positions and even then only at key points. In mobile warfare, open emplacements will be the general rule.

*b. Automatic rifle.*—Automatic rifles are habitually used in trenches or fox holes. They do not require a special emplacement, though such an emplacement increases their effectiveness particularly in maintaining direction of fire at night, in smoke, or in a fog. Figure 87 shows typical positions for automatic rifles. These positions should provide for—

(1) Firing recess in the parapet approximately of dimensions shown.

(2) Box for the rifle, 48 by 12 by 8 inches, with gas curtain.

(3) Box for ammunition, 20 by 20 by 12 inches, with gas curtain.

*c. Machine gun.*—Machine-gun emplacements are classified as hasty and deliberate.

(1) *Hasty.*—Due to the great fire power of machine guns and their importance in battle, they must be effectively concealed from enemy ground and air observation, and as time permits, effectively protected against effects of enemy fire. Concealment is of paramount importance but position of the weapon will be disclosed when it opens fire. Hence it is necessary to provide additional protection and overhead cover. In open warfare, time will generally permit only hasty emplacements to be prepared and immunity from enemy fire is secured mainly through concealment. However, even in open warfare the gun crew may secure some protection from shell fire while not actually operating the gun by occupying concealed slit trenches constructed near the emplace-

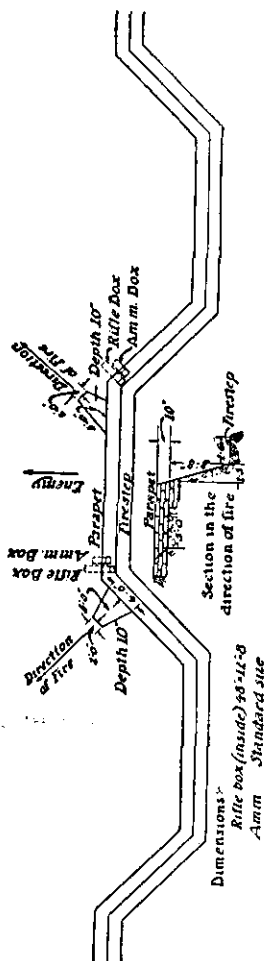

FIGURE 87.—Automatic rifle emplacement.

ment. As time permits, splinterproof or light shellproof cover over the emplacement will be provided, thereby securing protection additional to that furnished by concealment. A portable steel machine-gun emplacement that can be erected quickly where needed has been designed and is undergoing tests.

(2) *Deliberate.*—When position warfare develops, deliberate emplacements become the rule. In these, protection is secured at the gun position by cover of varying degree such as splinterproof, light, light shellproof, or massive concrete shelters, or by deep dugouts for the crew in connection with open emplacements. Concealment is always desirable.

(3) *Site and type.*—Considerations governing siting of machine guns and choice of type of emplacement to be employed are—

(a) Site and type of emplacement must be such that fire mission of the gun as demanded by the tactical situation may be fulfilled.

(b) Emplacement must be well concealed from ground and air observation.

(c) Protection for the gun and personnel in the form of trenches, shelter, or dugouts against fire not specially directed at the position should be provided.

The foregoing considerations are given in the order of their importance. In many cases it will be impossible to fulfill all these conditions, and choice of site and type of emplacement will be a compromise.

(d) The type of emplacement for a particular site depends on mission of the gun, time, material, and labor available, natural cover afforded by the site, character of the soil, and proximity of the enemy. It follows that in a defended area a single type of emplacement will not be found suitable for all the machine-gun positions. In a hastily organized defensive position where time and material are limited, emplacements necessarily will be of the simplest type that can be improvised quickly from local resources. On the defensive both the light and the heavy machine guns will usually be fired from emplacements. Hasty types will have to be based on a compromise between speed of construction and safety. Two standard types are in general use, open shallow and open

standing. Open emplacements are preferred because they can be constructed rapidly, require little revetting material, permit all around fire, can be adapted readily from shell holes, and are more easily concealed than the elaborate types. Their disadvantages are that they can be destroyed easily by light artillery fire and are exposed to air observation.

(4) *Standard dimensions and data.*—(a) For firing, the machine gun is set up in one of two positions known as the "normal sitting" and the "low" position. In the former, distance from the ground or firing platform to the muzzle of the gun is about 21 inches, and in the latter about 15 inches.

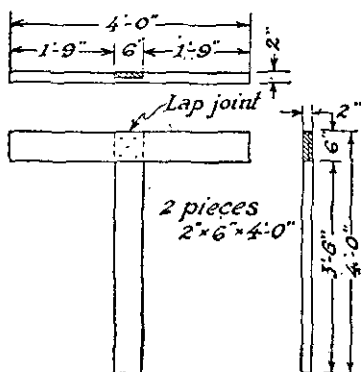

FIGURE 88.—Detail of T-base.

(b) When the gun is set up on open ground the low position is generally used. It may also be used in a shallow open emplacement.

(c) T-bases for machine guns when needed for use in soft ground are made of two pieces of 2-by-6-inch lumber, each 4 feet long, lap-jointed together to form a symmetrical T (see fig. 88). Wooden cleats may be nailed at each end of the T-base to prevent tripod leg from slipping.

(d) Space around firing platform in open emplacements should be at least 1 foot wide. The floor for standing emplacements is not less than 3 feet below the top of the T-base. The over-all height between the floor and ceiling of a covered emplacement is 6 feet (see figs. 96, 97, 100 and 101).

(e) The embrasure or opening through which the gun is fired in covered emplacements should be 10 inches high and wide enough to permit an arc of fire of  $45^{\circ}$ . A greater arc may be necessary, but some protection must be sacrificed to attain it.

(f) Headroom from top of embrasure to ceiling, 6 inches.

(5) *Establishing height of gun.*—(a) The machine gun is always sited with its muzzle as close to the ground as possible. It is merely necessary that the zone of fire clear the ground and that the line of sighting which may be several inches above the barrel clear the vegetation. The muzzle is kept low by setting up the gun in the low position. In emplacements since excavating is done, the muzzle may be at any height. The height depends entirely on the configuration of the ground over which the weapon must fire.

(b) In preparing any emplacement it is first necessary to determine the height at which the muzzle of the gun must be placed. This immediately fixes elevation of the gun platform, depth of excavation, and whether or not a parapet should be thrown up around the open emplacement.

(c) Because of the considerable labor involved in construction of any covered emplacement and the difficulty of making any changes after the emplacement is built, it is imperative that the exact position of the embrasure be determined before work is started. If there is any doubt as to the accuracy of the determination it is well to set up a gun in position before work is begun and from time to time during the progress of construction to see that no mistake is being made. To verify ability of the gun to cover the field of fire desired, trenches should be cut through any obstruction in at least two places in the arc of fire and a sight taken from the proposed location of the muzzle over the field of fire.

*d. Hasty emplacements.*—(1) *General.*—(a) In general, hasty emplacements will be open or at least with a minimum of cover. They depend for protection on concealment. Disadvantages of open emplacements may be reduced by concealing the emplacement as thoroughly as possible, by providing alternate emplacements, and by providing shelter for the gun



crew in connection with the emplacement, preferably with direct, covered communications between the shelter and an observation post so that timely notice may be given to man the emplacement. This step taken to reduce disadvantages of an open emplacement will ordinarily require considerable labor and material and the emplacement becomes a deliberate one.

(b) When time is available, a light cover may be constructed over the emplacement to give protection from the weather. If more than the lightest roof for weatherproofing is placed over the emplacement, the occupants will be buried and the gun put out of action when a shell bursts near it.

(2) *Heavy machine-gun open, shallow.*—(a) Figure 89 shows a standard, open, shallow emplacement for the heavy machine gun. If it has been determined that the muzzle of the gun can be placed close to the original ground level, an excavation of not to exceed 18 inches in any case is required. The water jacket must of course clear the ground, and allowance must be made in certain cases for depressing the muzzle as, for example, when the gun must fire down a slope. No parapet will be required when the muzzle is placed low. Surplus earth from the excavation may be placed at the sides and rear, but since the gun may have to fire over a wide arc, possibly even to the rear, the elevation of the parapet thus formed should not be so great as to prevent this. If the excavated earth is spread over a large area near the emplacement concealment becomes difficult. It is better at the expenditure of considerable labor to carry the earth from vicinity of the emplacement unless there is a convenient shell hole nearby where it may be dumped.

(b) The emplacement shown in figure 89 accommodates the gun and two men with water and ammunition boxes. The dimensions shown are those of the bottom of the pit. The sides may be vertical if the earth will stand, or sloped as nature of the soil demands. No revetment is necessary. The entire floor is at the same level, the maximum depth being about 16 to 18 inches. If height of the gun permits use of a low parapet, the depth of excavation is correspondingly reduced. By widening the pit about 1 foot on each side as shown by the broken line it may be made to resemble a shell hole. If the gun is set relatively high it is advantageous to

## GENERAL LAYOUT

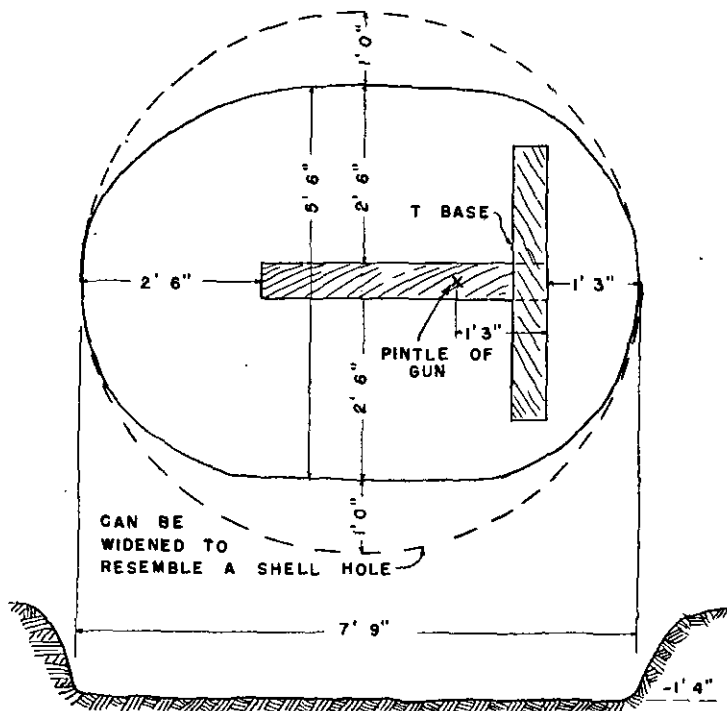
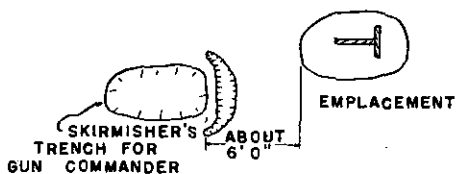

## DETAILS OF EMPLACEMENT

FIGURE 89.—Open, shallow emplacement for heavy machine gun.

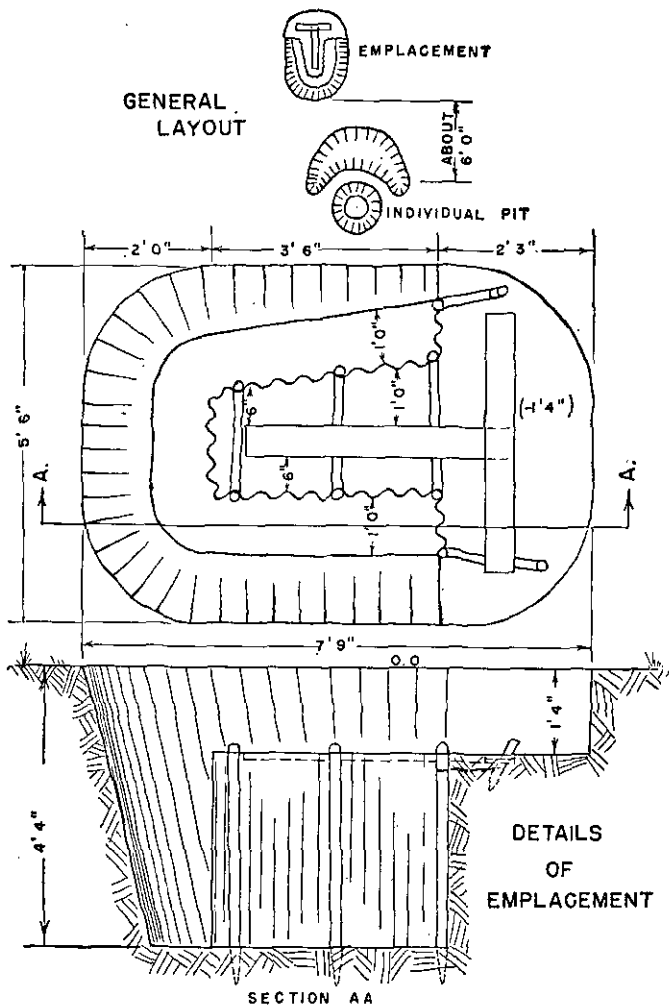

FIGURE 90.—Open, standing emplacement for heavy machine gun (T-base may be omitted).

deepen that portion of the pit occupied by the men a few inches to provide more cover. Sandbags built up under the pintle so that the gun rests on these sandbags rather than on the legs with additional sandbags placed on the legs will provide good support when the T-base is not available. Short sticks of proper diameter placed in the cleat and at right angles to the legs, and tying the legs together when in firing position also assist in steadying the gun when the T-base is not available. The ammunition is habitually placed in front of the T-base or in the same relative position if the T-base is not available.

(c) To construct an emplacement of this type, place the T-base in its correct tactical position or otherwise mark the correct tactical position of the gun. Mark the outline of the pit, rounding the corners if desired. Dig the pit to the desired depth, sloping the sides if necessary. Set the T-base flush with the bottom of the pit. This emplacement if of maximum depth (16 to 18 inches) requires about 60 cubic feet of excavation and in soft soil requires about 3 man-hours of labor to construct. If the soil is disposed of otherwise than as a parapet more time is required. A skirmisher trench should be dug opposite the right rear of the pit at a distance of about 6 feet for the gun commander if he cannot find natural cover nearby.

(3) *Heavy machine-gun open, standing.*—(a) The emplacement described above in figure 89 may be converted into a standing type as indicated in figure 90 by deepening that part of the pit occupied by the personnel.

(b) The gun platform should be revetted as shown to prevent caving under the shock of firing. Revetment of the platform should be vertical. The extra width of 12 inches of the platform on the left side is to accommodate the ammunition box in use. This emplacement allows slightly more than 180° traverse, permits personnel to stand while firing, and provides better cover for personnel than the shallow type. As this pit accommodates but two men there should be an individual rifle pit for the gun commander as for the shallow type emplacement. If a skirmisher trench has already been dug for the gun commander it will be necessary merely to deepen it.

(c) To convert a shallow type emplacement in light earth into a standing type and to deepen the gun commander's pit requires about 3 man-hours of work for the digging. Revetting requires about 3 man-hours.

(4) *Shell hole, machine gun.*—It will often be feasible to convert a shell hole into a shallow type emplacement. The sides of the shell hole should be broken down, and the bottom filled in level to the proper elevation. The final result should conform to the shallow type as illustrated. By expenditure of extra labor in building up and revetting a firing platform a shell hole may be converted into a standing type emplacement. A shell hole should not be selected for conversion into an emplacement merely because of saving labor, if the gun as so sited cannot completely fulfill its tactical mission.

(5) *Light machine gun.*—The light machine gun can be fired from either a shallow or a standing type emplacement as in the case of the heavy machine gun. The dimensions are indicated in figure 91. The gun platform for the light machine gun must be wider than for the heavy machine gun, and a different type of base must be provided. This is due to the fact that there are two rear legs of the tripod resting on the gun platform in the case of the light machine gun while there is but one rear tripod leg in the case of the heavy machine gun. The gun platform for the light machine gun is much shallower than that for the heavy. The open, shallow type involves excavation of only 15 cubic feet of earth; the open, standing type requires about 85 cubic feet.

(6) *Caliber .50 machine gun.*—This is similar to the emplacement for the heavy machine gun except that it is slightly larger due to the larger size of the machine gun. Instead of the over-all length of approximately 8 feet for the heavy machine gun emplacement a total length of 10 feet is required. Total excavation required is about 75 cubic feet for the shallow type and 150 cubic feet for the standing type. The T-base must of course conform to the construction of the caliber .50 gun.

(7) *37-mm gun (M1916).*—(a) The 37-mm gun usually fires with sight defilade using indirect laying methods with observation at or near the gun position. When possible the gun is placed in a position affording sight defilade just behind a crest or parapet.

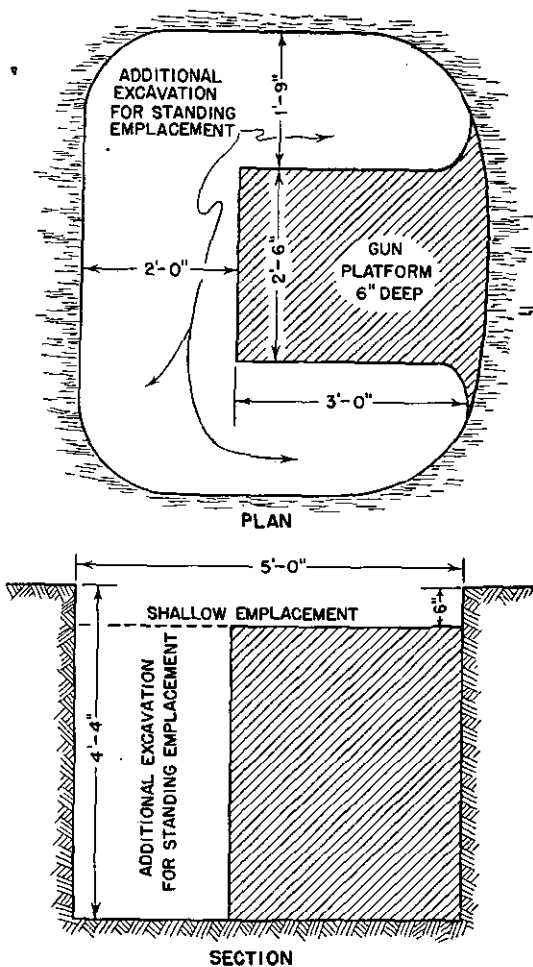

FIGURE 91.—Light machine-gun emplacement.

(b) In providing emplacements for it, the 37-mm gun may be considered similar to the machine gun. In open warfare there is usually no time for construction of elaborate emplacements, and concealment is the best protection. The simple, open emplacements built under these conditions may be concealed in a clump of bushes or in any small terrain features. It is always well to prepare alternate emplacements at least 100 yards apart laterally so that fire directed on one will not destroy the other.

(c) Figure 92 illustrates a shallow, open emplacement convertible into standing type for the 37-mm gun, M1916, similar to the open type emplacement for the machine gun. In this emplacement the gun may be traversed by means of movement of the trail as well as by means of the traversing mechanism. The emplacement allows with the traversing mechanism an arc of fire of  $90^\circ$  which may be increased by widening the rear part of the pit. The shallow emplacement requires about 55 cubic feet of excavation. To convert the shallow to the standing requires about 63 cubic feet additional excavation.

(d) The 37-mm antitank gun weighs about 950 pounds. Its total crew consists of only 5 men. It cannot therefore be moved quickly by hand from one emplacement to another, especially over rough ground. For that reason it usually will be fired without special emplacement and from an open position taking maximum advantage of sight defilade. The shield with which the gun is equipped offers some protection to its crew. Figure 93 shows a type of emplacement which might be used for the 37-mm antitank gun in exceptional circumstances such as in stabilized or semistabilized warfare. This emplacement requires from 175 to 200 cubic feet of excavation.

(8) *Mortars.*—(a) The mortar being a high angle fire weapon, natural concealment may often be obtained easily. Fences, houses, woods, and ravines offer excellent concealment. Defiladed positions are the rule. The emplacements should have naturally covered approaches such as wooded ravines in order that communications and supply of ammunition may be maintained easily.

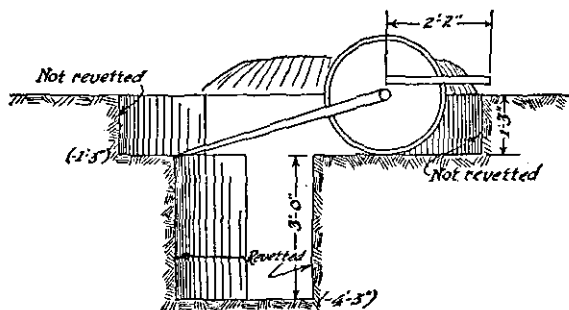
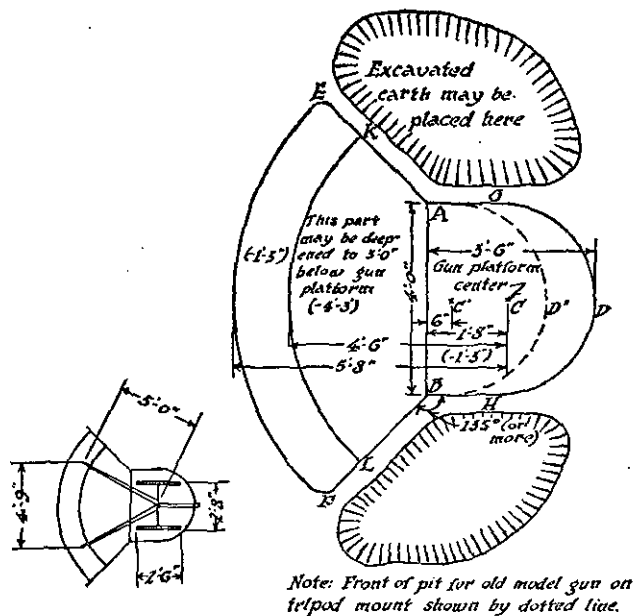
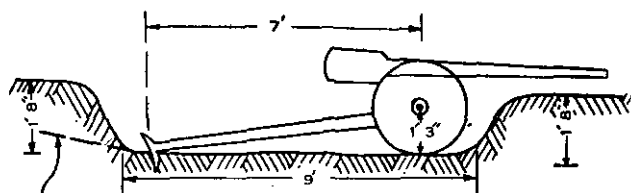

FIGURE 92.—Open emplacement for 37-mm gun, M1916 (shallow and converted to standing type).





RAMP TO ROLL GUN INTO EMPLACEMENT

PROFILE

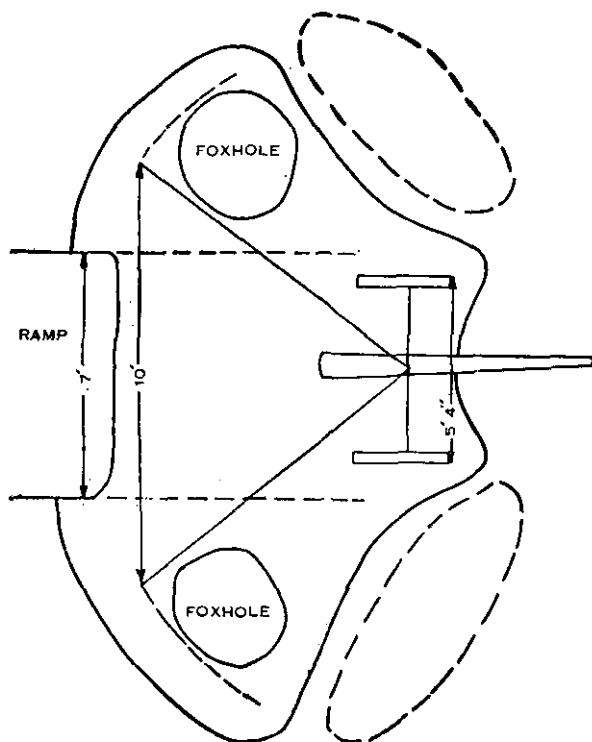

PLAN

FIGURE 93.—Emplacement for 37-mm antitank gun.

(b) In mobile situations emplacements seldom are occupied for any great length of time. Preparation of the position is usually limited to digging pits for the base plate. In stabilized situations emplacements may be occupied for a considerable length of time and should be made correspondingly more complete.

(c) *81-mm.*—The 81-mm mortar, being a battalion high trajectory weapon, is usually located in the rear part of the battalion area. If suitable defiladed firing positions cannot be found it will be necessary to prepare emplacements. Figure 94 shows a typical emplacement. This emplacement requires excavation of about 150 cubic feet, including that necessary for ammunition niches. The crew squat in the emplacement.

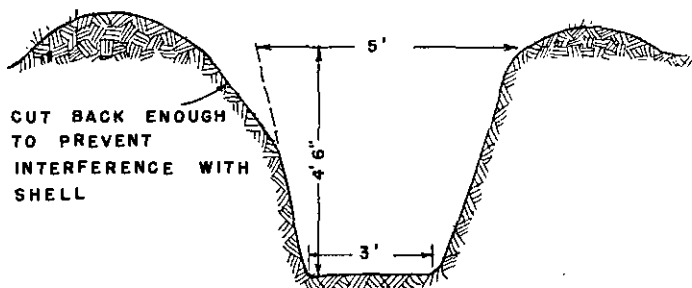

FIGURE 94.—Emplacement for 81-mm mortar (ammunition niches to be dug into side of pit).

(d) *60-mm.*—The 60-mm mortars of the front-line companies are usually emplaced well forward in the battalion area. Except in rough terrain they will usually require emplacements. The 60-mm mortars of the unit in battalion reserve are located farther to the rear. Emplacements will be prepared for them if no suitable defiladed firing positions can be found. Figure 95 shows a typical emplacement for the mortar. The crew squat in the pit. The bottom of the emplacement should be at least 3 feet below the ground surface in order that the mortar shell may be inserted in the muzzle without being exposed to the enemy. This em-

placement requires excavation of about 60 cubic feet of earth, including that necessary for ammunition niches.

(9) *Command and observation posts, and aid stations.*—Table XXII gives approximate time and labor estimates for these works. Plans for the same are not given as the nature of the work will vary considerably depending on the terrain features, material available, etc. The working parties and man-hours given are the minimum required in order to provide protection comparable to that given other elements of the defense in a hasty organization of the ground. See paragraphs 39c, and 64. For other types of command posts see paragraphs 57e and 58f.

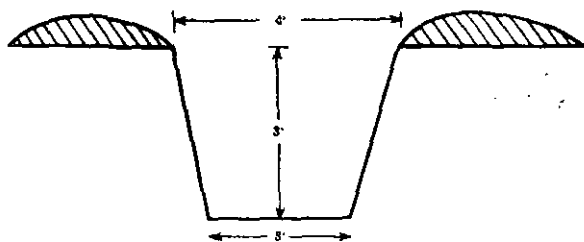

FIGURE 95.—Emplacement for 60-mm mortar (ammunition niches to be dug into side of pit).

TABLE XXII.—*Approximate time and labor estimates for hasty works*

Work	Number of men	Number of man-hours in—		
		Soft soil	Average soil	Hard soil
Company command post, hasty.....	2-3	12	18	24
Company observation post, hasty.....	2	7	10	12
Light 2-man shelter in trench †.....	2	7	10	12
Aid station, local, hasty.....	2-4	12	18	24
Battalion observation post, hasty.....	2-4	10	15	20
Battalion command post, hasty.....	8-16	50	75	100
Battalion aid station, hasty.....	8-16	50	75	100

† For plans see figure 128.

*e. Deliberate emplacements.*—(1) *General.*—(a) Deliberate emplacements are any which require considerable expenditure of time, labor, and material for their construction. Such emplacements may be of covered or open form. In the latter, protection is provided for personnel in shelters separate from the emplacement itself. The essential difference between hasty and deliberate emplacements is that in the latter, actual physical protection for personnel from fire is provided either at the gun position or nearby, while in the former concealment generally is the principal dependence for protection. This does not imply that concealment is not also of great importance in deliberate emplacements. It is essential if for no other reason than to secure maximum benefit from the surprise element.

(b) Because deliberate emplacements are constructed under conditions where time, material, and labor are not the controlling elements, it is possible to standardize on several types, one of which or a combination of which will be found suitable for almost every infantry weapon position. These types are described in considerable detail below. Reference should also be made to section VIII.

(2) Three grades of protection in covered emplacements, with variations in each grade, might be provided (see par. 53 and table XXVI, section VIII, which give details of thickness of protective materials required):

(a) *Splinterproof.*—Proof against shrapnel, machine-gun bullets, and small splinters but not proof against light artillery or 37-mm gunfire. Can be provided easily.

(b) *Light shellproof.*—Proof against shells from artillery guns, howitzers, and mortars up to and including 6-inch (155-mm). Requires considerable time and special materials for construction.

(c) *Heavy shellproof.*—Proof against 8-inch (200-mm) shell and against single hits of heavier shell. Requires great expenditure of time, labor, and material. Provided only in a protracted defense.

(3) *Machine-gun emplacement with splinterproof cover.*—A simple type of machine-gun emplacement with splinterproof cover for guns and crew, accommodating a section of two heavy machine guns, is shown in figure 96. This type may be used in connection with existing trenches or in an isolated

position with or without concealed approaches. This emplacement can be adapted readily to fire the light machine gun or caliber .50 machine gun.

TABLE XXIII.—*Material list and work data for two-gun heavy machine-gun emplacement (fig. 96)*

Item	Unit	Quantity
<b>Logs:</b>		
6-inch diameter, 8 feet long.....		24
4-inch diameter, 10 feet long.....		220
Poles, 2-inch diameter, 6 feet long.....		40
Timbers, 6 by 8 inches, 3 feet long.....		4
Boards, 1 by 12 inches, 2 feet long.....		5
Stakes, 12 inches long.....		200
T-bases, standard.....		2
Corrugated iron or roofing paper.....	Square feet.....	750
Camouflage material.....	do.....	1,900
Sandbags.....		240
Wire, smooth, No. 10.....	Feet.....	500
Brush for revetting steps.....	Bundles.....	1
Excavation.....	Cubic feet.....	1,500
<b>Work:</b>		
Excavation, 12 men.....	Hours.....	10
Revetting, roofing, etc., 12 men.....	do.....	14
Total, 12 men.....	do.....	24
Total man-hours.....		288
8-hour shifts, 12 men.....		3

(4) *Covered emplacements with shellproof protection.*—(a) *General.*—Covered emplacements with shellproof protection have the great advantages that the crew may remain at all times in comparative safety at their battle positions and that the gun is at all times ready to go instantly into action and may even remain in action during a barrage. Such emplacements are also practically immune from attacks by tanks. They are therefore desirable for important positions which are to deliver the most essential defensive fire. They also are especially suited to some forms of terrain. The masonry pill box type for instance is suited to positions in woods and villages and on hillsides where a limited field of fire suffices.

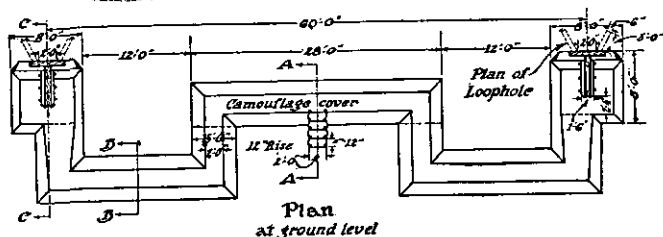
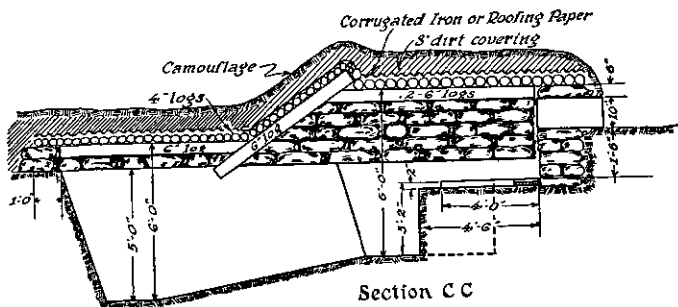
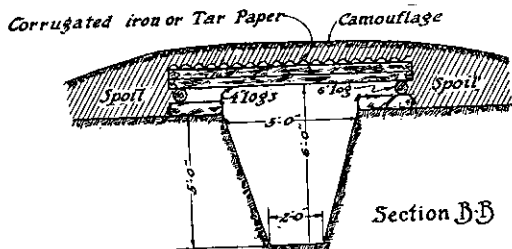
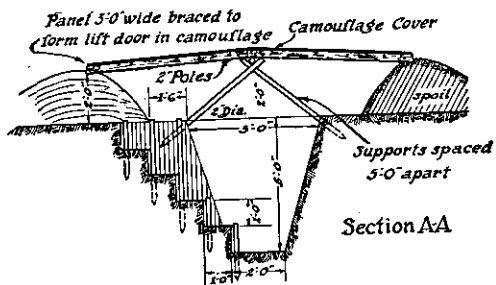

FIGURE 96.—Two-gun heavy machine-gun emplacement with splinterproof shelter.

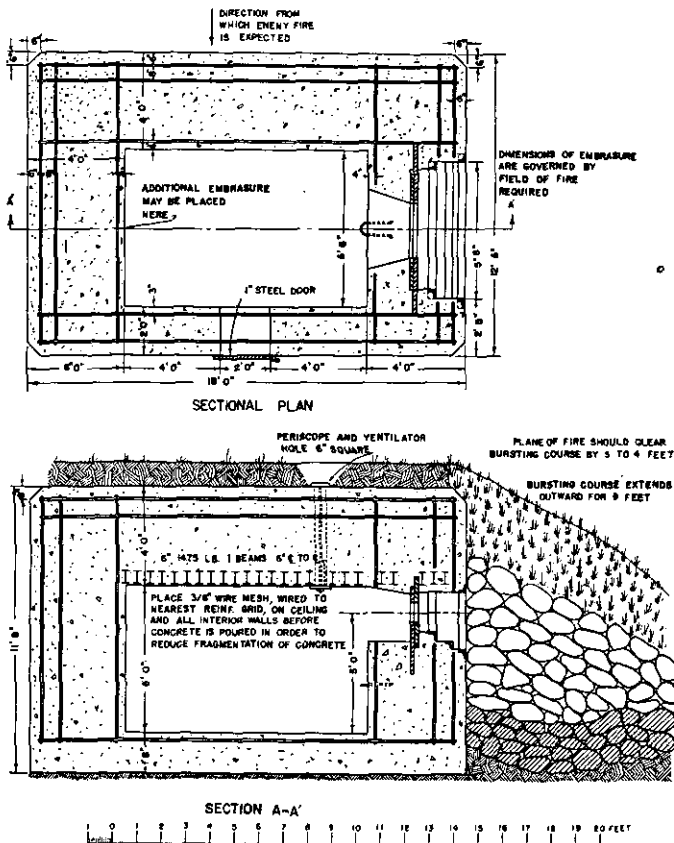

FIGURE 97.—Sectional plan and elevation, light shellproof machine-gun emplacement.

#### NOTES

Mix: 1: 2: 3 by volume.  
Water cement ratio .90 by volume.

All reinforcement grids of  $\frac{5}{8}$ -inch steel bars spaced 8 inches c to c in squares welded or wired together, welding preferred. Outside grids to be placed 6 inches from surface, inside grids 4 inches from surface.

Ties consisting of 4 strands of  $\frac{3}{16}$ -inch iron wire between two surface grids with average spacing of 1 foot four inches in both

directions; stirrups of  $\frac{5}{8}$ -inch metal between inner front and rear surface grids with average spacing 3 feet 0 inches horizontally and 8 inches vertically.

Concrete faces not protected by earth or bursting courses may be faced with  $\frac{1}{2}$ -inch to 1-inch steel plates if attack by infantry weapons at close range is anticipated.

The design should be regarded as typical and a guide for emplacements to meet tactical needs of a locality. Additional firing ports may be provided and shape of the emplacement modified. Emplacements should be sited normally in groups for enfilading fire and should be mutually supporting within groups.

The disadvantages of covered emplacements are that they require considerable time for their construction, they seldom can be constructed in near presence of the enemy, and it is practically impossible to render them invisible in open terrain to hostile observation. The view and the field of fire are also necessarily greatly restricted. In order to reduce risk of shell fragments or rifle bullets entering the embrasure the field of fire is generally limited to about  $60^\circ$ .

(b) *Light shellproof reinforced concrete.*—Figures 97, 98, and 99 show an emplacement providing protection against 155-mm shells. A shelter of the same dimensions but without loopholes may be used for sheltering two gun crews to operate machine guns from nearby open emplacements. In this case it should be lowered so as to be concealed more easily, and the thickness of the floor may be reduced to 12 inches. Due to the large amount of material and more or less elaborate construction plant required, use of concrete emplacements is restricted to positions not under direct observation of the enemy and provided with good transportation facilities, preferably near a railway line.

A minimum period of 2 weeks must be allowed for hardening of portland cement so that the emplacement may be considered effective, and 1 month for it to attain practically full strength. High early strength cement attains an effective strength in 24 hours. In soft ground in order to prevent shells from penetrating and exploding under the floor, a course of broken rock as indicated in the figure, or concrete bursters (see fig. 121) should be placed protecting the exposed sides. The embrasure is fitted with a pair of armor steel doors set in the concrete. The steel doors are sufficiently thick to withstand armor-piercing caliber .50 machine-gun fire. Table XXIV gives material list and work data.



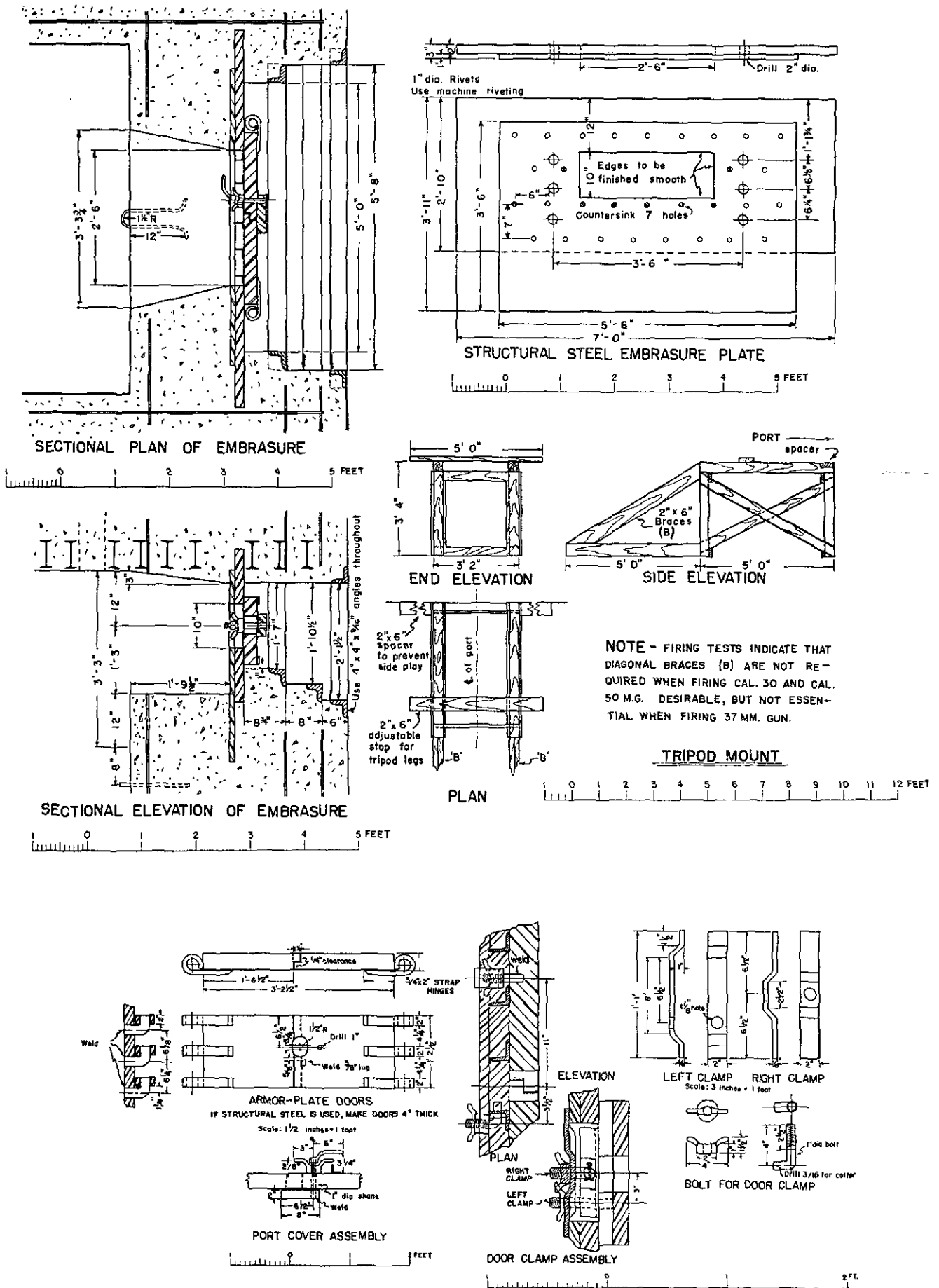

FIGURE 99.—Section and details of embrasure and tripod mount, light shellproof machine-gun emplacement.

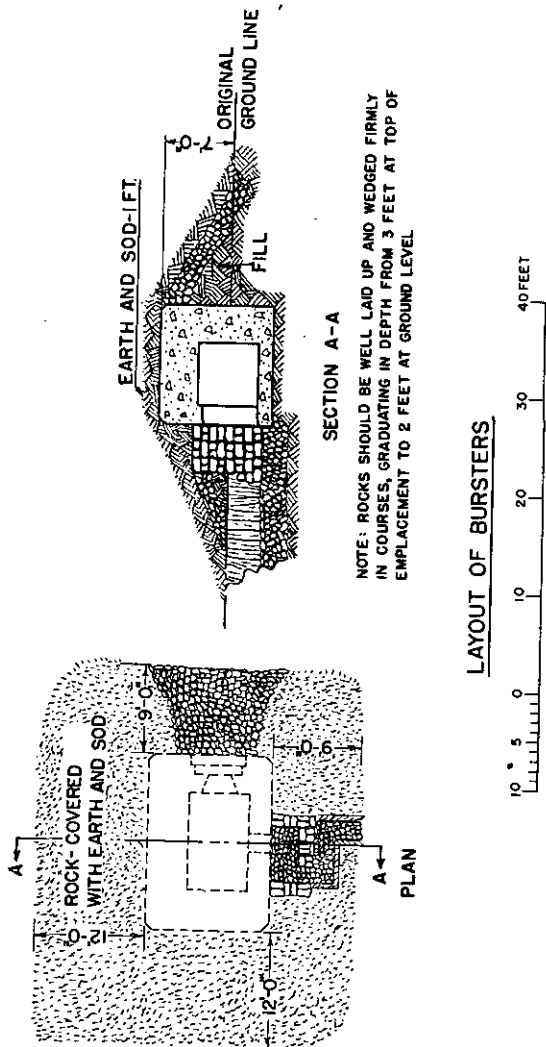

Figure 98.—Lay-out of bursters, light shellproof machine-gun emplacement.

TABLE XXIV.—Material list and work data for light shell-proof machine-gun and 37-mm gun emplacement (figs. 97, 98, 99)

Item	Unit	Quantity	Weight (tons)
Cement.....	Barrels (approximately 4 cubic feet per barrel).	143	26.8
Sand.....	Cubic yards.....	43	53
Broken stone or gravel (for cement).....	do.....	64.5	88
Water.....	Gallons.....	3,800	16
		(approximately)	
I-beams, 6-inch.....	Pieces 9 feet 6 inches long.	24	1.7
Round iron bars for reinforcing grids $\frac{5}{8}$ -inch.	Linear feet.....	6,900	3.6
Iron wire for stirrups, $\frac{3}{16}$ -inch.....	do.....	1,600	.08
Angles for embrasure corner armor.....	do.....	52	.40
3 each 4 by 4 by $\frac{3}{16}$ inch by 6 feet 4 inches.			
1 each 4 by 4 by $\frac{3}{16}$ inch by 5 feet 8 inches.			
2 each 4 by 4 by $\frac{3}{16}$ inch by 2 feet $1\frac{1}{2}$ inches.			
2 each 4 by 4 by $\frac{3}{16}$ inch by 1 foot 7 inches.			
Wire mesh, $\frac{3}{8}$ -inch for ceiling and walls..	Square feet.....	263	.20
Embrasure panels complete, consisting of—		1	1.6
1 armor steel plate 1 inch by 3 feet 6 inches by 5 feet 6 inches.			
1 armor steel plate 2 inches by 2 feet 10 inches by 7 feet.			
1 armor plate door 3 feet $2\frac{1}{2}$ inches by 1 foot $2\frac{1}{2}$ inches by 4 inches thick, with hinges, door clamp assembly, and port cover assembly.			
6 angles 2 by 2 by $\frac{3}{8}$ inch by $9\frac{1}{2}$ inches long.			
Steel door for port complete, consisting of—		1	.35
1 steel plate 2 feet 6 inches by 6 feet by 1 inch thick.			
2 angles 2 by 2 by $\frac{3}{8}$ inch by 5 feet 6 inches.			

TABLE XXIV.—Material list and work data for light shellproof machine-gun and 37-mm gun emplacement (figs. 97, 98, 99).—Continued

Item	Unit	Quantity	Weight (tons)
Steel door for port, complete, consisting of—Continued.			
2 angles 2 by 2 by $\frac{3}{8}$ inch by 2 feet			
1 port cover assembly and cap			
2 hinges 4 by 6 by $\frac{1}{2}$ inch thick			
1 lock bar $1\frac{1}{2}$ by $\frac{1}{2}$ inch by 1 foot 3 inches.			
Door hook, hasp and hook, hinge bolts.			
Cover for periscope hole complete, consisting of—		1	
1 plate 11 by 11 inches by $1\frac{1}{4}$ inches thick.			
1 plate 11 by 11 inches by $\frac{1}{2}$ inch thick.			
1 round rod $\frac{3}{4}$ inch by 3 feet long			
Sandbags		174	
Broken stone for burster course	Square yards	110	165
Lumber:			5
For forms:			
2-inch	Square feet	975	
2 by 6 inch	Linear feet	700	
2 by 4 inch	do	330	
2 by 2 inch	do	36	
1 by 12 inch	do	50	
1 by 6 inch	do	40	
1 by 4 inch	do	40	
For tripod mount:			
4 by 4 inch	do	22	
1 by 4 inch	do	37	
2 by 6 inch	do	31	
Tie wire, No. 9 gage for forms	do	800	
Nails:			
Sixteenpenny	Pounds	60	
Twenty penny	do	60	
Total weight (approximately)			363
Excavation:			
Emplacement	Cubic yards	58	
Burster course	do	49	
Volume of concrete	Cubic yards	82	
Backfill	do	120	

TABLE XXIV.—Material list and work data for light shellproof machine-gun and 37-mm gun emplacement (figs. 97, 98, 99).—Continued

Item	Unit	Quantity	Weight (tons)
<b>Work:</b>			
Excavation and fill.....	Man-hours.....	320	
Erecting forms, placing burster course, etc.	.....do.....	350	
Concrete, placing reinforcing, mixing, placing, and stripping forms.	.....do.....	450	
Total.....	.....do.....	1,120	
Total, 8-hour shifts, 20 men.....	.....do.....	7	
<b>Period for hardening (minimum):</b>			
Portland cement.....	Days.....	14	
High early strength cement.....	Hours.....	24	

(5) *Additional types.*—(a) Figure 100 shows a light shellproof emplacement connected with an underground shelter.

(b) Figure 101 shows a machine-gun emplacement inside a ruined house.

(c) Protection and concealment for covered emplacements may be obtained in a variety of ways, depending on proximity of the enemy, local resources in material, and amount of labor available.

*f. Ventilation of covered emplacements.*—Ventilation of covered emplacements is most important due to the quantities of carbon monoxide liberated during firing of machine guns. The gas is highly toxic, odorless, and colorless. Ventilation of covered machine-gun emplacements in order to free them of this gas takes precedence over protection against enemy gas. It is desirable to have on hand in emplacements difficult to ventilate by ordinary means a hand-operated portable blower similar to that on a blacksmith's forge. In addition a gas curtain placed between the muzzle of the gun and the firer will exclude a large proportion of the gas.

A removable metal sleeve slightly larger than the jacket of the gun may be made to fit over the outside of the barrel and jacket and to project a few inches beyond the muzzle.

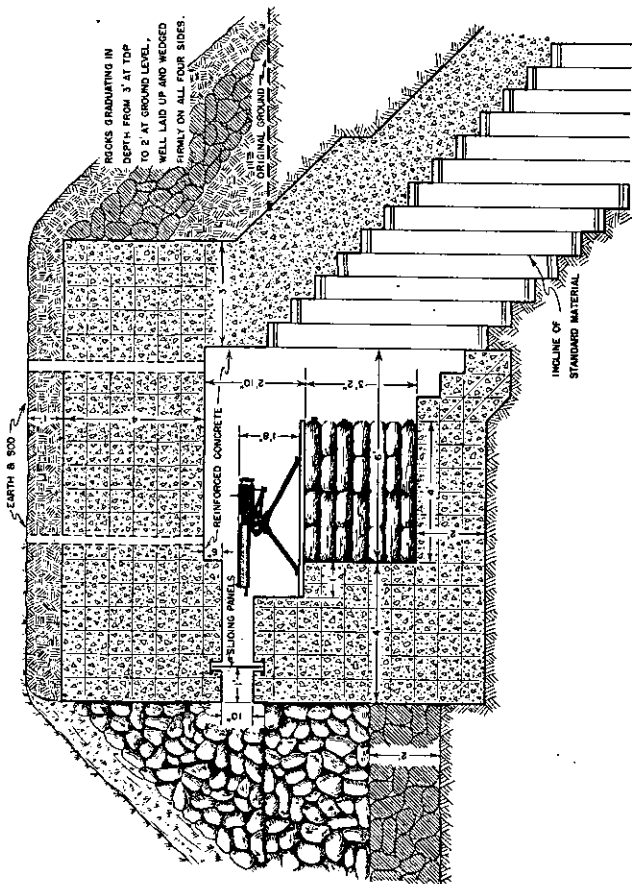

FIGURE 100.—Light shellproof machine-gun emplacement connected with underground shelter.

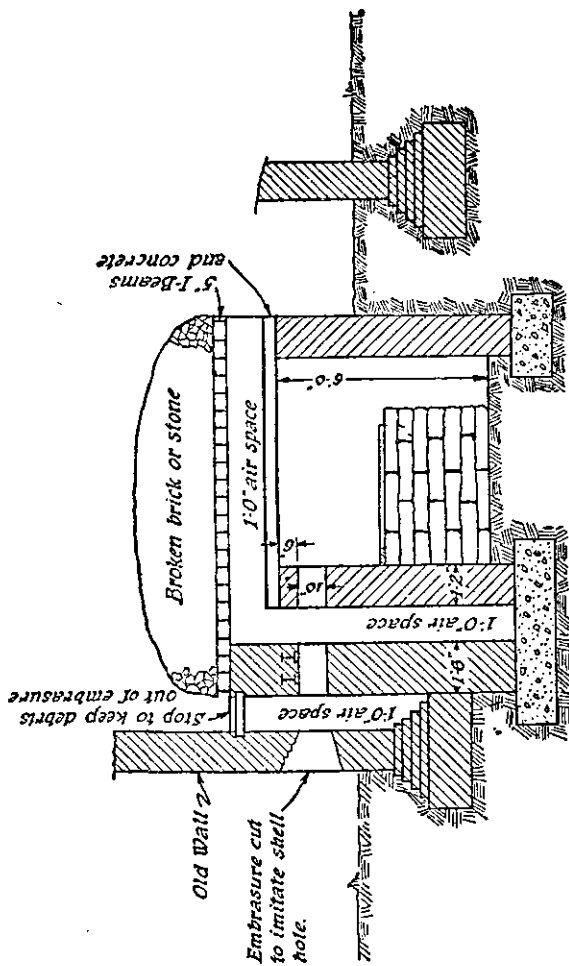

FIGURE 101.—Machine-gun emplacement in ruined house.

It is not necessary that this sleeve project outside the loophole. Action is that firing of the gun causes a vacuum inside the sleeve which draws in air from the rear. The powerful forward blast of air so caused blows all gases out of the loophole. Use of this device has been found highly satisfactory in exclusion of gases. It should always be provided when thickness of walls of the emplacement is such as to make it difficult or even impossible to project the muzzle of the gun outside the edge of the loophole.

*g. Time and labor estimates for emplacements.*—See table XXV below.

TABLE XXV.—*Time and labor estimates for emplacements, using pioneer tools*

Emplacement description	Cubic feet excavation required	Man-hours <sup>1</sup> (approximate)	Reference in this manual	Remarks
Automatic rifle	37	1½ to 4	Fig. 87	
Machine gun:				
Light:				
Shallow	15	½ to 1	Fig. 91	
Standing	85	5 to 10	Fig. 91	
Heavy:				
Shallow	60	3 to 7	Fig. 89	
Standing	120	7 to 13 <sup>2</sup>	Fig. 90	
Caliber .50:				
Shallow	75	3½ to 9	Par. 48d (6)	
Standing	150	9 to 18	do.	
Splinter proof, double.		288	Fig. 96	Material at site.
Reinforced concrete.		1,120	Figs. 97, 98, 99	Do.
37-mm gun.				
M1916:				
Shallow	55	2½ to 6	Fig. 92	
Standing	118	7 to 13	Fig. 92	
Antitank	175 to 200	10 to 24	Fig. 93	
Mortar:				
81-mm	150	9 to 18	Fig. 94	
60-mm	60	3 to 7	Fig. 95	

<sup>1</sup> First figure is for soft earth, the second for hard earth.

<sup>2</sup> Does not include revetments.



*h. Drainage.*—Every effort is made to exclude surface water and seepage from emplacements and water that enters must be removed. The means and methods described in paragraphs 36 and 59 are applicable directly or with proper adaptations to drainage of emplacements.

■ 49. ARTILLERY.—*a. References.*—Detailed information is contained in FM 4-5, and in the appropriate Field Artillery Field Manuals.

*b. Sunken batteries.*—(1) Artillery emplacements may be distinguished according to their construction as *surface* or *sunken*; surface if the area on which the piece rests is on the same level as the ground surface, and sunken if below it.

(2) Ease of gaining protection is an advantage of sunken emplacements. When the carriage is lowered the undisturbed earth around the excavation gives cover to the men at the piece. Parapets around the emplacements are easily built and give additional cover. Camouflage nets may be lower which decreases chance of detection of the position. Advantages of sunken emplacements can be secured for howitzers because of their high angle of fire more readily than for guns.

(3) Disadvantages of sunken batteries are time required to dig the emplacement, difficulty of draining the pit, and loss in mobility. For light artillery the pieces are seldom dug in except in deliberate positions. Ordinarily there is not sufficient time to sink the pieces before opening fire and the batteries must be prepared for rapid displacement. The difficulty of removing artillery from a sunken emplacement can be partly overcome by construction of a ramp leading from the gun pit.

(4) The depth to which a piece may be lowered depends on height of axis of the bore, lowest angle of elevation, and nature of the soil. The 75-mm gun may be sunk 2 feet 6 inches without interfering with firing of the piece. The depth of pit for the 155-mm howitzer depends largely on nature of the ground. All pits must be drained and in wet ground or low places this may present difficulties. Unless satisfactory arrangements can be made to keep surface and ground water out of the pits, they are not constructed. The 155-mm gun, which has a split trail, requires a recoil pit

approximately 2 feet 6 inches deep for high angle fire. These characteristics in addition to the great weight and difficulty of maneuver preclude lowering this gun below the ground surface. Emplacement of the 240-mm howitzer requires excavation of a large pit for its platform which is located at the center of a cleared level space. It is therefore impracticable to sink the upper level of the platform below the ground surface.

(5) The 75-mm gun in a sunken position and with parapets is shown in figure 102 ① and ②. As shown in ② an embrasure is cut in the ground surface to permit further lowering the piece. This embrasure and all excavated ma-

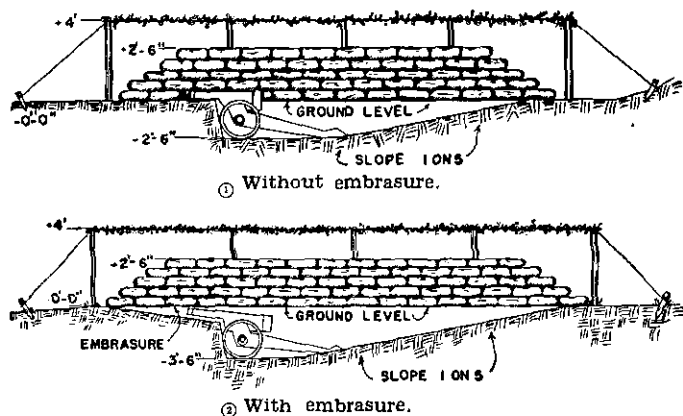

FIGURE 102.—75-mm gun in sunken position.

terial must be included under the camouflage net or otherwise concealed. Before deciding upon the depth of the pit, it must be ascertained whether the embrasure will require an excessive amount of work or extend too great a distance in front of the gun. The platform for the piece should not be given its final depth until the embrasure is completed. Where no embrasure is to be cut, depth of the pit is readily obtained from height of the bore and elevation of the piece. In all sunken batteries a suitable ramp leads to the platform for the piece. Slope of this ramp is approximately 1 vertical to 5 horizontal.

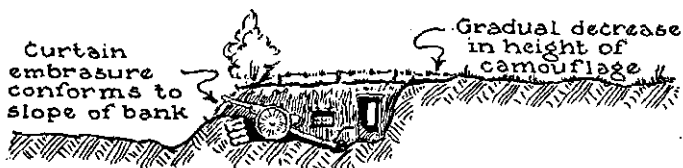

FIGURE 103.—75-mm gun in bank along edge of road.

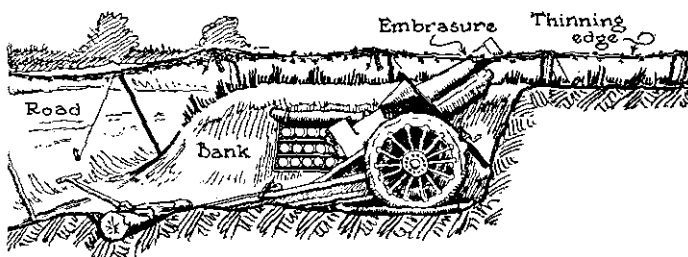

FIGURE 104.—155-mm howitzer in bank along edge of road.

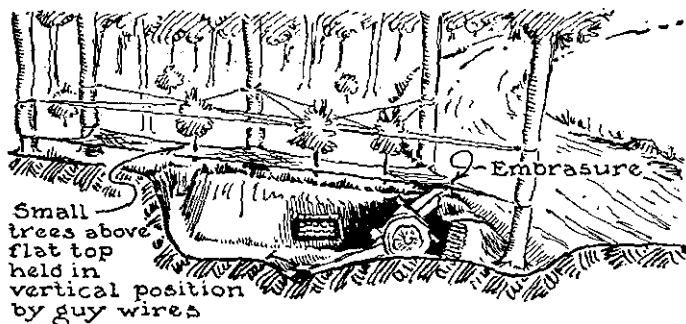

FIGURE 105.—155-mm howitzer in bank in edge of woods along road.

(6) *Small banks*, particularly those along roads, afford protection to artillery pieces by digging an emplacement in the bank. The use of a ramp is obviated in this case as the level of the floor of the emplacement may be made the same as the adjacent road or surrounding ground. See figures 103, 104, and 105. Note ammunition recesses made in side of emplacement.

*c. Trenches for cannoneers.*—(1) As soon as possible after occupation of a position or prior to occupation when the situation permits, work is started on narrow slit trenches for the cannoneers. These trenches may be dug between intervals of firing or at the first available opportunity.

(2) The trenches are so sited that the men at the piece can enter the trenches promptly and also be ready to return to their action positions at a moment's notice. They are as close to the cannon as service of the piece will permit. Care is taken when the trenches are dug that they will not later interfere with the trail when direction of laying is changed. A sufficient bank of solid ground is left between the trail and the trench to sustain thrust of the trail. Normally a short trench is constructed on each side of the piece. These are offset if possible so that a single hit may not enflade both trenches.

(3) Dimensions for these trenches can only be approximated as each case must be considered separately. Too many features enter into consideration to permit any standard. In general, trenches are as narrow as will permit a man to enter, and each trench is long enough to contain half the section. A trench 2 feet 6 inches wide and 12 feet long fulfills these requirements for the 75-mm gun or the 155-mm howitzer. A slightly longer trench is required for the 155-mm gun or 240-mm howitzer. Locations and dimensions for trenches are shown in figures 106, 107, and 108. The figures simply show plans that will work under certain conditions. Earth excavated from the trench is thrown up to form a parapet around the trench. This decreases amount of excavation but does not give as good protection as may be obtained if the trench is made deep enough to give desired cover without a parapet. Capacity of the soil to stand up in the trench walls and facilities for drainage frequently

determine which method may be adopted. Should it be found necessary, the trench may be braced as shown in figure 26.

*d. Parapets.*—(1) After the piece is in firing position and the narrow trenches have been dug for the cannoneers, para-

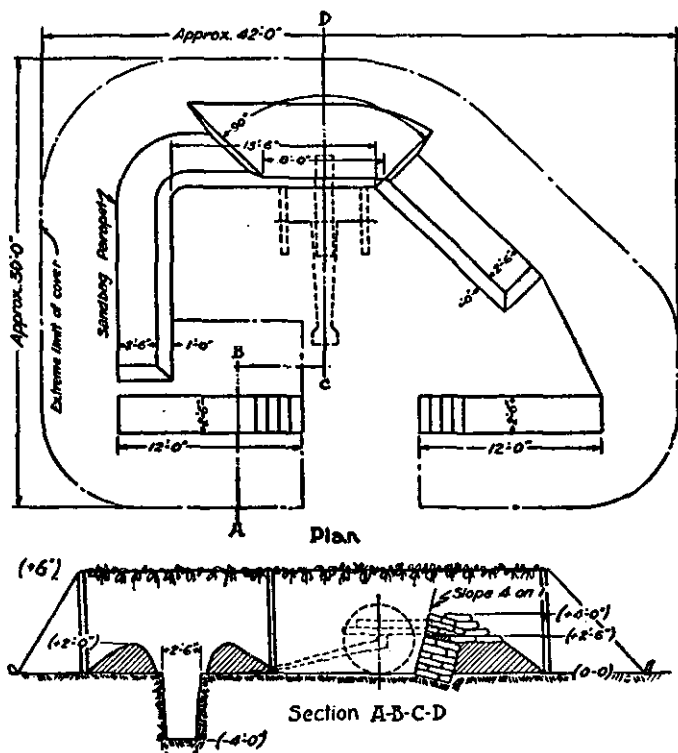

FIGURE 106.—Emplacement for 75-mm gun (French 75-mm, high speed rubber-tired wheels).

pets are thrown up around the piece or piece and caisson to protect matériel and personnel. In addition to giving actual cover the parapet gives the men a greater sense of security and has a certain moral effect that increases efficiency of the cannoneers under fire.

(2) Location and size of the parapet depend largely on ground, tactical situation, and type of piece. The parapet is as close to the piece as will permit necessary movement at the emplacement. The inner slope is close to the piece

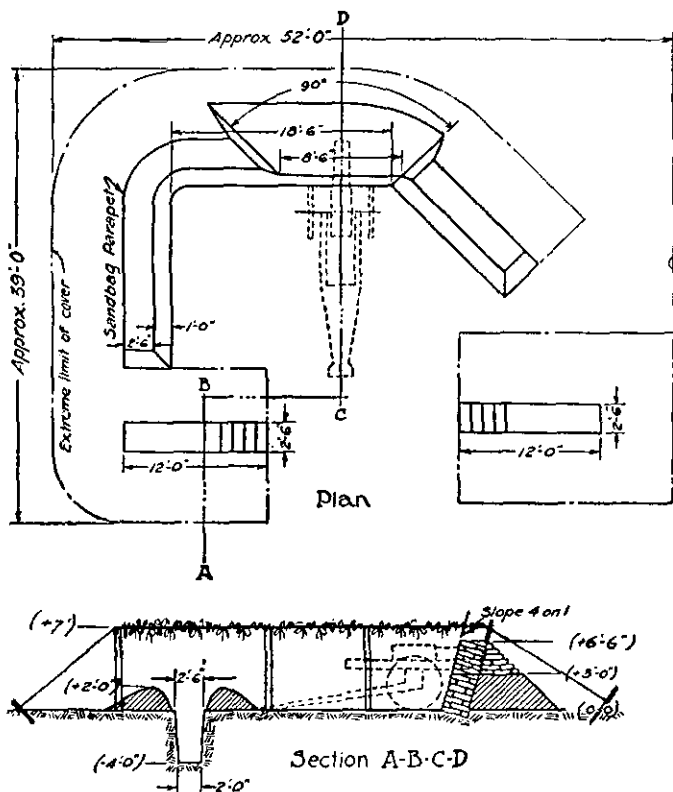

FIGURE 107.—Emplacement for 155-mm howitzer, M1918 (high speed).

wheels. Height of the parapet is such as to give maximum cover to the cannoneers, not less than 4 feet, approximately height of the wheels. For complete cover the height is 6 feet 6 inches above the platform or surface on which the carriage rests.

(3) When lower angles of fire are used for a gun an opening may be left in the parapet, the width of which is dependent on traverse necessary. The parapet is made splinter-proof, requiring thickness at the top of at least 2 feet 6 inches. A greater thickness is obtained whenever possible.

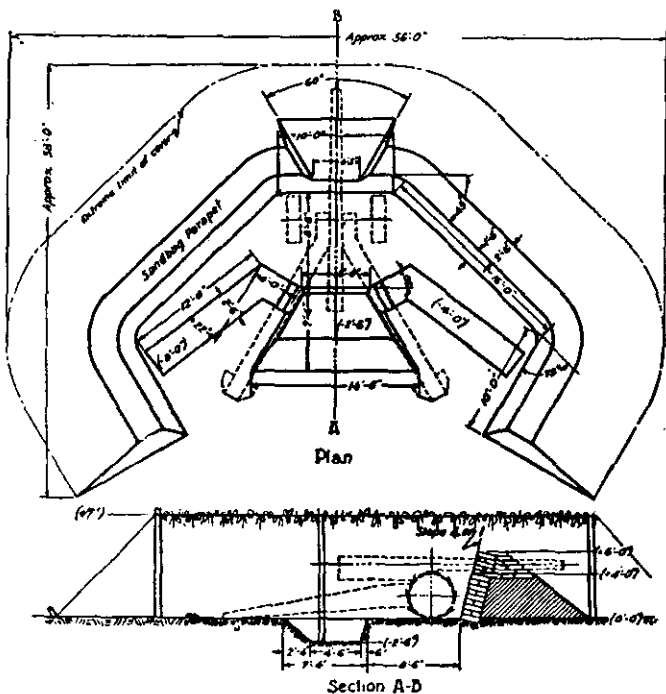

FIGURE 108.—Emplacement for 155-mm gun.

(4) Earth is not borrowed close to the foot of the exterior slope since future enlargement of the parapet may be desirable. Unless revetted, the exterior slope should not be steeper than 1 on 1.

(5) Parapets erected around surface batteries are shown in Figures 106, 107, and 108. Location and dimensions of the elements shown in these figures are given as a guide and not

as a standard. With necessary modifications in shape and dimensions similar emplacements can be constructed for all types and models of weapons. In a deliberate type of defense the caisson is not included within the parapet. Also in this case, when the nature of the ground permits, the piece may be sunken to give cover without building up the parapet. In all cases precautions are taken to conceal the position before any work is done. It is useless to conceal a position which has been built within view of the enemy.

(6) If the space occupied by the piece and caisson is excavated to a depth of approximately  $1\frac{1}{2}$  feet, sufficient earth is obtained to construct the parapet to give 4 feet of cover. This method usually reduces difficulties of concealment.

*e. Concrete emplacement for 155-mm guns.*—(1) A special case arises in permanent emplacement of tractor-drawn artillery for fire at naval targets. The principal consideration in such cases is to get a wider traverse than  $60^\circ$ . The guns are placed on concrete foundations on which there is a central platform, an annular recoil pit, and a  $180^\circ$  traversing circle for the trails as shown in figure 109. Wheel shoes and spades are removed and spades replaced by steel guide plates bolted to the trails. These plates fit over the curved railroad iron which is imbedded in the semicircle of reinforced concrete and which is anchored by steel hooks. A steel curb band surrounds the raised concrete inner circle and serves as a guide for the wheels of the carriage, thus preventing the trail plates from binding on the guide rail in traversing. The guide rail and curb band are kept lubricated and the trails moved by hand as necessary. The gun is traversed in the normal manner, the trails being moved only when necessary to keep the target within the  $60^\circ$  traverse limit of the gun. Mobility of the gun remains the same.

(2) Slit trenches for the protection of personnel manning a gun on this type of emplacement must of course be placed outside the concrete semicircle. A parapet having its inside wall along the diameter of the semicircle may be erected and continued around the sides and rear of the emplacement so as to include the slit trenches. An embrasure must be left in the front large enough to permit the piece to be fired from all positions throughout its  $180^\circ$  of traverse.



*f. Platforms.*—(1) Platforms built to support wheels of the mount have certain advantages. They—

- (a) Insure stability of the piece.
- (b) Facilitate a change in direction.
- (c) Facilitate adjustment of fire.
- (d) Increase accuracy of fire.

They are indispensable in soft or muddy ground and are usually constructed when a position is occupied for any continued period. The platform is a deck or floor on which the piece may be worked easily; it must be sufficiently stiff to

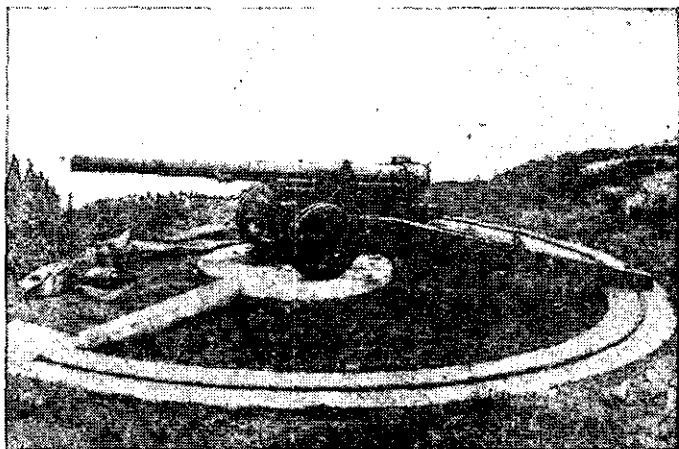

FIGURE 109.—155-mm gun on permanent emplacement.

resist shock of firing and of such a nature that it can be repaired readily if damaged. Because of the loads to be handled and the necessarily confined space in which the personnel must work, the ground soon becomes mud in bad weather and makes additional labor for the cannoneers. The ground around the platforms should therefore be well drained, and if opportunities offer, the entire surface of the emplacement decked or floored.

(2) In hasty position, if platforms are used they are improvised from materials found at the site or immediately

available. Brush, logs, planks, or broken stone can be used for this purpose. An improvised log platform may be constructed quickly by burying three or four sills in the ground parallel to direction of fire and laying a row of logs upon them at right angles. They can be held in place by wiring or spiking the top layer to the sills or by covering the entire platform with about 6 inches of earth (fig. 110). In any case, the completed platform should not be higher than the ground on either side of it. If broken stone is available, a better bearing surface for the gun may be made by excavating and filling with stone.

(3) In deliberate positions wooden platforms are constructed and may be made of standard dimensioned timber obtained from the supply service. Due to their weight it is not feasible

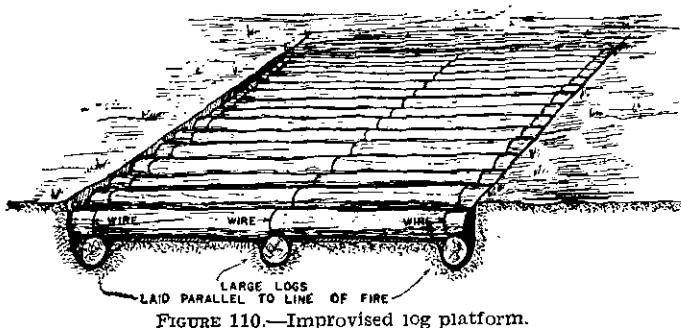

FIGURE 110.—Improvised log platform.

to have the platforms made up in the rear and brought forward assembled. Concrete platforms are not recommended for pieces not specially designed to be fired from concrete bases as they are not sufficiently resilient to take up the shock of the recoil without injury to the piece. Wooden platforms are simple in design, made of standard size lumber, and sufficiently strong to support the weight. It is desirable to make them large enough to provide space for the men loading the piece.

(4) The 75-mm gun platform shown in figure 111 consists of sills, posts, and deck. It is given as a guide for construction of similar platforms to accommodate the various types and models of field artillery, it being necessary only to vary the size of the platform for the particular weapon.

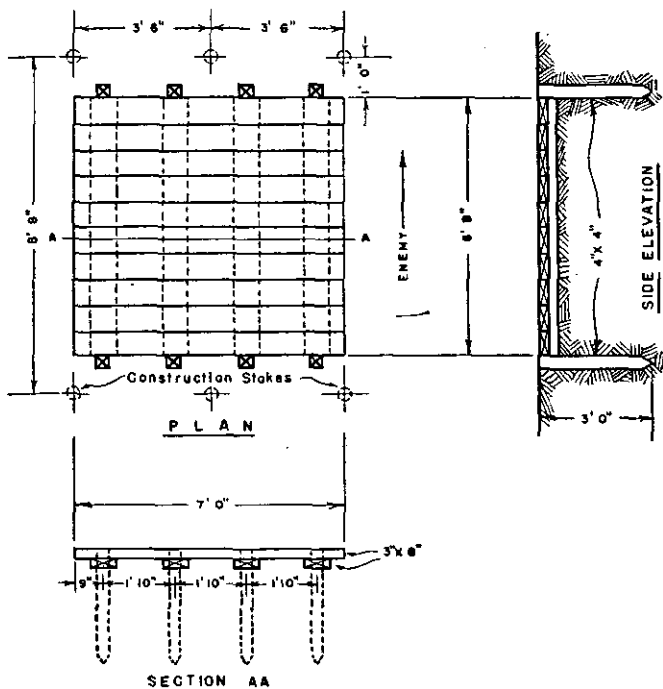

FIGURE 111.—Platform for 75-mm gun.

*Material list*

Description	Size	Number required
Posts.....	4 by 4 inches by 3 feet.....	8
Sills.....	3 by 8 inches by 6 feet 8 inches.....	54
Decking.....	3 by 8 inches by 7 feet.....	10

(5) A platform will seldom be required for the 155-mm gun. Wheel supports or separate large timber blocks will be all that are necessary except under the most unfavorable soil conditions. Under certain conditions large timber blocks

placed under the wheels suffice. By use of these less digging is involved both for the recoil pit and in the use of jacks than when the piece rests on the wheels or track shoes alone. Moreover, the gun can be placed in position in slightly less time. The specially prepared wheel support is made of two runners wide enough to give full bearing to the wheels, strong enough to support the load, and braced to prevent twisting or movement out of line (see fig. 112).

*Material list*

Description	Size	Number required
Crosspieces.....	3 by 8 inches by 8 feet 7 inches.....	5
Runners.....	14 by 14 inches by 14 feet.....	2
Bolts.....	½ by 15 inches.....	12

*g. Trail supports.*—(1) A trench for the trail spade of the 75-mm gun or the 155-mm howitzer is dug immediately upon occupation of the position. For continuous firing additional support must be given spades. The trail supports prevent displacement in traversing, assist in shifting the trail, and facilitate rapid change of target.

(2) In a hasty position, the support consists of a log or timber set in the earth behind the spade to distribute the force of the recoil transmitted through the trail. A log at least 6 inches in diameter and 4 feet long should be used for the 75-mm gun; it is held in place by a strong picket near each end. The bottom of the log is at least 1 foot below the ground surface. Broken stone or similar material placed in rear of the log will assist in holding it in position. A support built of sandbags will hold for a limited time provided the spade does not rest directly against the bags. A fascine used in place of the log will adjust itself to the spade and give a better cushion. For the 155-mm howitzer a log at least 8 inches in diameter and 6 feet long is used. Due to the heavy blow delivered by the spade the log must be held firmly in place by strong pickets and a cushion of

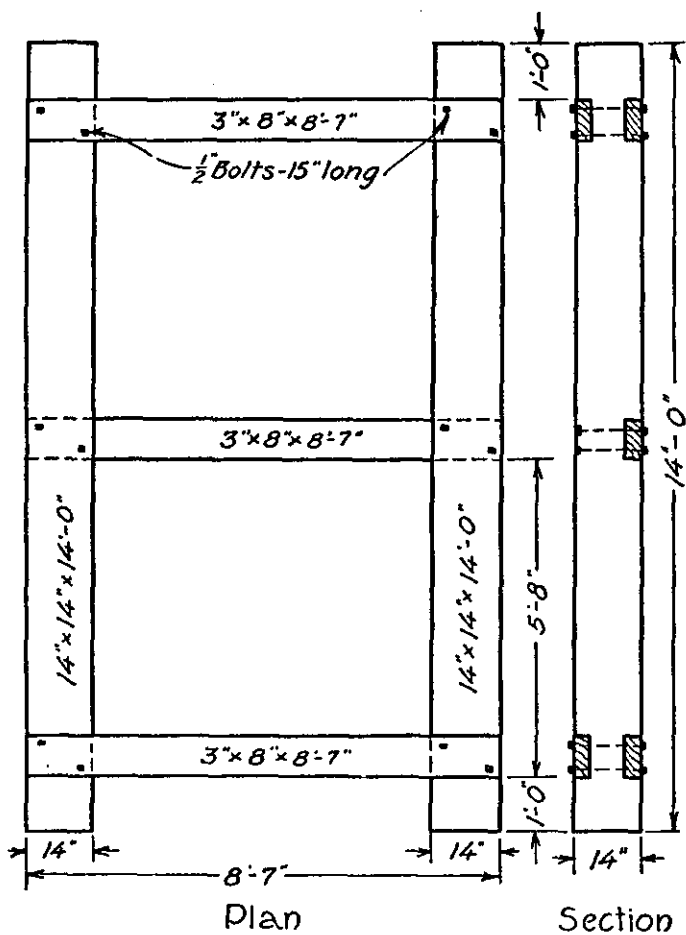

FIGURE 112.—Wheel support for 155-mm gun.

broken stone or similar material placed in rear of the log. Sandbags are of little use for the trail of this howitzer.

(3) In a deliberate position, particularly where platforms are used, a more permanent support is built. Such a trail support for the 75-mm gun made of 8- by 10-inch timbers and 4 by 4 posts is shown in figure 113. The timbers are cut to shape in rear areas and furnished as shown in the figure.

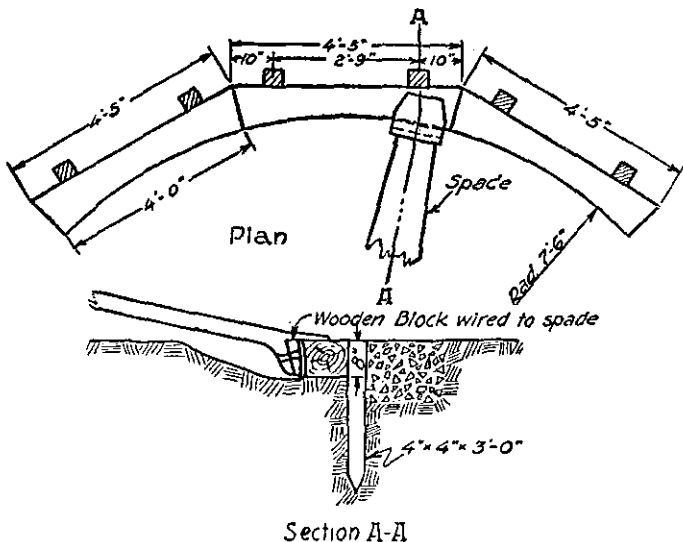

FIGURE 113.—Trail support for 75-mm gun.

A wooden block shaped to the arc of travel is fastened to the spade. The timber supports are held in place by stakes and by a backing of broken stone in a trench. When increased ranges and high angle fire are required, an additional trail support is constructed in a similar manner inside of and lower than that shown in figure 113. The depth below the surface depends on elevation to which the gun is to be raised. If no dimension timber is available, a support of this type may be built of fascines and 3- or 4-inch round pickets. The fascines are cut to 4-foot lengths. No wooden block

will be required on the spade when fascines are used. The trench for the fascine is dug deeper than for the timber because the fascine is more difficult to keep in place.

(4) A trail support similar to that described above may be used for the 155-mm howitzer; 12- by 12-inch timbers are used and preferably braced to other timbers set in a trench dug 2 or 3 feet in rear. The timber is cut on a 12-foot arc. A wooden block 8 by 16 inches and 2 feet 10 inches long is fastened to the spade as shown in figure 114. When additional supports are placed in rear of the trail circle the space between the two is filled with broken stone, brick, or

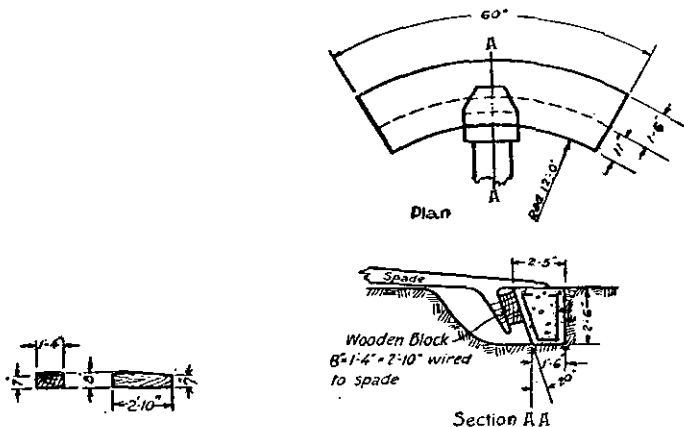

FIGURE 114.—Concrete trail support for 155-mm howitzer.

similar material. When fascines are used, one laid in front and one in rear of the spade will prevent the trail from burying itself.

(5) A concrete trail support for the 155-mm howitzer is illustrated in figure 114. Concrete trail supports are only practicable in situations where the position can be prepared some time in advance of occupancy.

(6) The 155-mm gun generally requires no additional support for the trail beyond that afforded by the ground itself. In wet or soft ground or for continuous firing from one emplacement additional support may be required. This

can be provided easily by placing a large log or timber under the shoe normal to the trail. The timber preferably should be about 12 inches square in section and 12 feet long, extending 6 feet on each side of the center of the trail, and placed flush with the ground surface. If smaller timbers or logs are to be used, they are placed one on top of the other in a trench of the proper depth.

*h. Drainage.*—See paragraphs 36, 48*h*, and 59.

■ 50. ANTI-AIRCRAFT MATÉRIEL.—*a. Concealment and camouflage* will provide the most effective protection for anti-aircraft guns, searchlights, power plants, and accessories. When in firing and operating positions, anti-aircraft matériel is sometimes difficult to conceal and, whenever the situation permits, protection for matériel and personnel will be provided. This will normally consist of sunken emplacements or parapets built up around the unit of matériel or perhaps a combination of the two. In the case of parapets splinterproof protection should be provided as a minimum. Suggestions for such protection are given below. These suggestions should not be considered as definite methods for the various units of matériel shown since field conditions will require modifications or changes for each case. Dimensions shown will not necessarily be correct for all equipment but are given with the idea of providing minimum protection without limiting capabilities of the matériel.

*b.* The most effective protection for searchlights against enemy gunfire or air attack is afforded by concealment of the lights when not in action, and by concealment of the power plants. Mobile lights should be kept in concealed positions during daylight hours, and their operating positions should be changed frequently. When the time is available a limited amount of protection should be provided for matériel and personnel by digging circular pits or erecting parapets of such depth or height, respectively, as will not interfere with the beam or obstruct the field of view in any direction. Mobile power plants for searchlights should be located in a wood, ravine, or other depression, and deflated from enemy fire. The distance between the light and the power plant should be the maximum consistent with length of the cable.



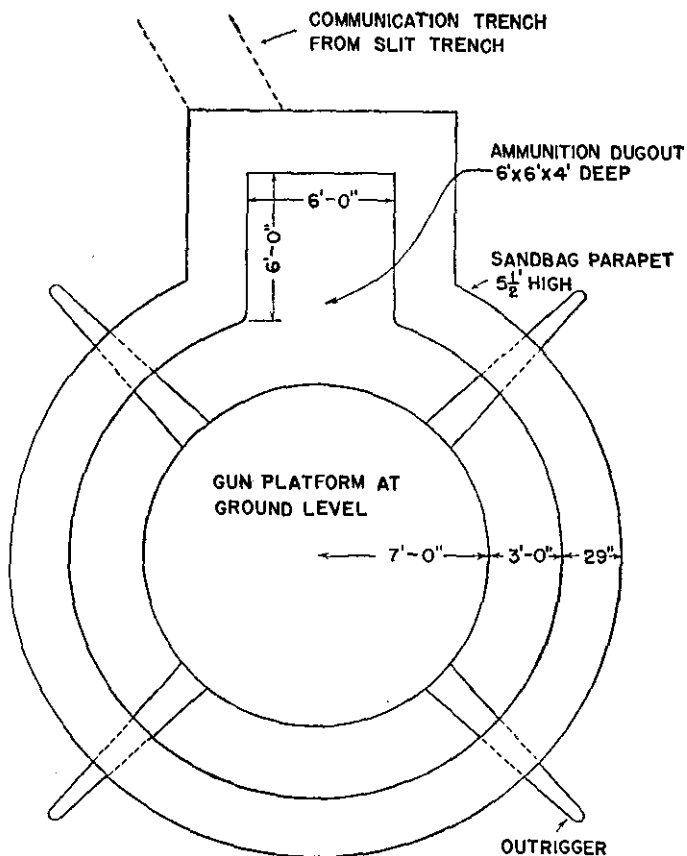

FIGURE 115.—Protection for 3-inch anti-aircraft gun (average outside dimensions for camouflage purposes).

c. Figure 115 shows parapet protection for the 3-inch anti-aircraft gun mount, M-2. The parapet consists of sandbags placed alternately as stringers and headers with total thickness of parapet being one header and one stringer or 29 inches. For other mounts the parapet would be placed approximately 3 feet outside of the gun platform. The height of parapet is regulated by the height of the trunnion and may

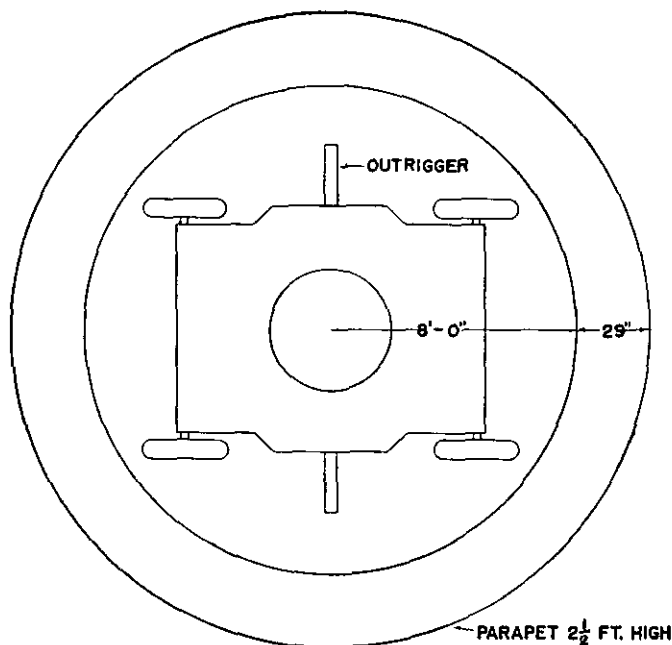

FIGURE 116.—Protection for 37-mm automatic cannon (AA) (average outside dimensions for camouflage purposes).

be increased when field of fire is limited. Gun platform may be solid, leveled ground, with or without a layer of gravel or crushed rock, or a platform of 3- by 8-inch plank (or other heavy plank) may be constructed. Slit trench near the gun for full crew of 20 men would be provided with communication trench to the gun only when on permanent defense in rear areas.

d. For complete details see FM 4-105.

e. Figure 116 shows similar parapet protection for 37-mm automatic cannon (AA). The height of the parapet is based on trunnion height of 33 inches. The height of the parapet may be increased when field of fire is limited but must always permit maximum possible field of fire. No slit trenches or

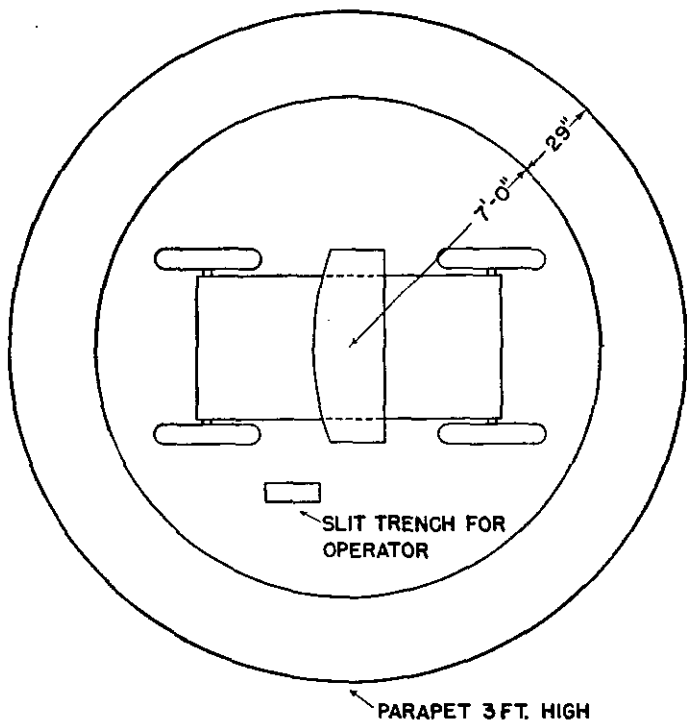

FIGURE 117.—Protection for anti-aircraft searchlight (average outside dimensions for camouflage purposes).

communication trenches are provided as camouflage must be chief protection. Wheel supports may be provided in wet or soft soil.

f. Figure 117 shows similar parapet protection for anti-aircraft searchlights. The parapet height of 3 feet permits

10° elevation and this height of parapet may be increased when field of fire is limited. Wheel supports may be provided in wet or soft soil. One-man slit trench alongside light for operator is shown.

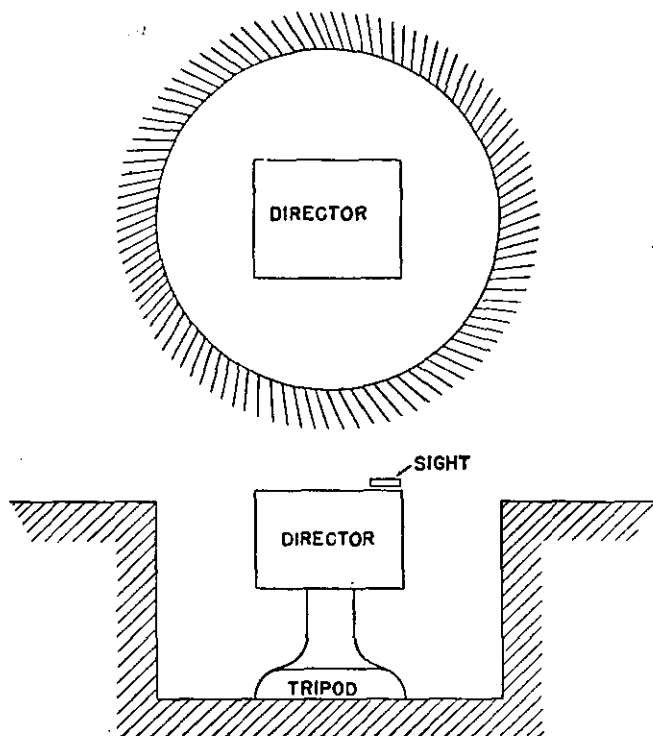

FIGURE 118.—Protection for director, gun battery (ramp or other means of emplacing instruments are not shown).

*g.* Suggestions for protection of other matériel are as follows:

(1) *Searchlight unit.*—(a) *Control station.*—Dig circular pit about 2½ feet in diameter and 4 feet deep.

(b) *Power plant*.—Can usually use natural defilade. When necessary a sandbag parapet to height of plant should be constructed.

(c) *Sound locator*.—Build sandbag parapet to level of bottom of lowest horn and just large enough to permit efficient operation. Slit trench nearby for crew of 4 men.

(2) *Director, gun battery*.—Exact dimensions cannot be given. Dig circular pit large enough to allow efficient operation and deep enough to bury director but enabling sight (lo-

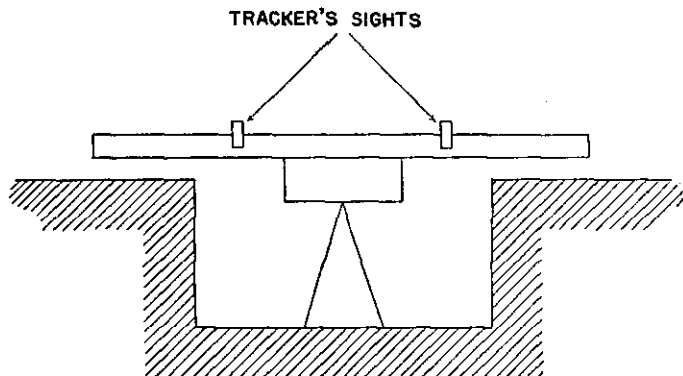

FIGURE 119.—Protection for height finder, gun battery (ramp or other means of emplacing instruments are not shown).

cated on top of director) to function at zero elevation. See figure 118.

(3) *Height finder, gun battery*.—Exact dimensions cannot be given. Dig circular pit for tripod just deep enough to allow tube to rotate freely above ground and just large enough to allow azimuth and elevation trackers to operate in pit. See figure 119.

*h. Drainage*.—See paragraphs 36, 48*h*, and 59.

## SECTION VIII

### PROTECTED SHELTERS

■ 51. CLASSIFICATION.—*a. Based on degree of protection*.—Protected shelters in rear areas for protection against aerial

bombardment are necessary. An indication of degree of protection necessary against airplane bombs is given in paragraph 29. However, sufficient experimental data and experience are not available on this subject to state that a particular airplane bomb requires the same degree of protection as a certain artillery projectile. Therefore protected shelters are classified according to degree of protection they afford against artillery projectiles, as—

(1) *Splinterproof shelters* protect against rifle and machine-gun fire, splinters of high-explosive shell, and grenades, but not against direct hits by 3-inch shells. They require only that an overhead cover of compact earth of about 1 foot in thickness (or its equivalent in other material) be securely supported. When these shelters are numerous and are carefully located, casualties may be greatly reduced.

(2) *Light shelters* protect against direct hits and in some cases against a continued bombardment by 3-inch shells.

(3) *Light shellproof shelters* protect against continuous bombardment by all shells up to and including 6-inch.

(4) *Heavy shellproof shelters* protect against continuous bombardment by at least 8-inch shells. Some types may be proof against larger shells or against all types of artillery fire.

*b. Based on method of construction.*—Shelters may further be classified according to method of construction which depends on character of the ground, materials available, and protection required as—

(1) *Surface.*—These structures or at least the greater portion of them are built at or above the surface of the ground. This type has maximum observation and exit facility and requires a minimum of labor; on the other hand, it is relatively conspicuous, requires considerable cover material, and provides the least protection. Shelter of this type is seldom used for protection of personnel in advanced lines unless it can be concealed in woods, on a steep reverse slope, or among the buildings of a village, or unless the underground water level is so close to the surface that the cut-and-cover type cannot be used. However, one exception to this rule may be the reinforced concrete shelter though this type often approaches cut-and-cover construction. Light shelters consisting of almost any type of small improvised shed covered

with a layer of earth may be used for protection of ammunition and stores. These shelters should be of small capacity, well dispersed, and carefully concealed.

(2) *Cut-and-cover.*—(a) This type consists of an open excavation in which framework for the shelter is placed, after which the excavation is backfilled around and over the framework to the level of the original surface, or somewhat above. To increase resisting power of overhead cover concrete, steel beams, broken stone, and other materials of high resistance to penetration are used in roof construction. It is a type intermediate between the surface and the cave shelter.

(b) Comparing it with the cave, the cut-and-cover shelter is adapted for use as dressing stations because it is easily cleaned, is well ventilated and lighted, and facilitates ready admission and evacuation of casualties. Cut-and-cover shelters are generally more quickly constructed but require much larger quantities of material than cave shelters. They do not resist intensive shelling as well and are more difficult to conceal than cave.

(c) When surface and underground water or hardness of underlying rock makes construction of cave shelters impracticable, cut-and-cover shelters may be used. They are also used where need for rapidity of exit prohibits use of cave shelters (as in important machine-gun shelters in or near the front line), in wooded areas or in buildings where concealment is easy and where ample material is available, and in situations requiring immediate shelter which can be most quickly obtained by this type.

(d) A cut-and-cover shelter providing protection against 6-inch shell does not usually present great difficulties, but it is generally impracticable to attempt to gain protection by cut-and-cover methods against heavier shell without constructing the shelters partially or entirely of concrete.

(3) *Concrete shelters.*—With adequate plant and materials for aggregate and for forms, protection may be obtained by either surface or cut-and-cover methods by construction of concrete shelters.

(4) *Cave shelters.*—(a) Cave shelters are constructed entirely below the surface of the ground by mining methods and have a cover of undisturbed or virgin earth. They are

the least conspicuous of all types, afford maximum protection before the shelter can be completed, and require a minimum of material. They have the disadvantages of limiting observation, unsatisfactory living conditions, difficult exit, and difficult drainage and ventilation.

(b) It is difficult if not impossible to increase overhead protection of these shelters after completion since protection depends upon depth at which the chamber is built. For this reason it is important not to underestimate amount of protection needed when the depth is determined. On the other hand, it is equally important not to overestimate amount of protection needed because of time, labor, and material involved in going to unnecessary depths.

■ 52. CHOICE OF TYPE.—The type adopted should be suitable to the situation; each selection is a separate and distinct problem. The more important considerations are—

*a. Tactical considerations and requirements.*—(1) The *primary purpose* of a protected shelter is to permit troops to remain at or very near their combat positions in comparative safety during hostile bombardment. Therefore use and degree of protection necessary are usually the most important tactical considerations.

(2) The terrain should be considered with especial reference to slope and its effect on type of entrances and rapidity with which overhead cover can be gained and the disposal of spoil. The existence of wooded areas and buildings which provide materials and facilitate concealment should also influence the decision. Reverse slope positions are difficult for artillery to hit and are usually drained easily.

(3) *Location.*—(a) Shelters should be near the combat or assembly positions of troops occupying them. This rule of the utmost importance near the front is of relatively less importance toward the rear.

(b) Facilities for cover and concealment afforded by terrain influence the location of shelters. Steep reverse slopes, quarries, etc., can be prepared to afford excellent shelter with comparatively little labor. Every advantage should be taken of any natural shelter in the locality, tactical considerations permitting.



(4) *Concealment.*—(a) It is important that location and number of shelters be concealed from hostile air and ground observation.

(b) Surface shelters to be inconspicuous must be hidden by existing features of terrain as in a wood or among buildings in a village.

(c) For concealment cut-and-cover shelters must be kept low. The surface of the ground where disturbed must be restored to its previous appearance. Necessary measures must be taken to conceal the work while in progress.

(d) Cave shelters are the easiest to conceal, as they do not disturb the natural surface of the ground. However, it is difficult to dispose of the spoil without attracting attention of the enemy.

(e) It is very important during construction to conceal all signs of activity. Construction materials and excavated earth must be carefully camouflaged and strict camouflage discipline demanded of the men carrying on the work.

(f) Concealment is facilitated by placing the entrance to a shelter in a trench, thereby providing a protected outlet and inlet and avoiding overground trails or footpaths.

(5) *Observation.*—Shelters should if practicable be located to afford necessary observation and be provided with means of observation such as loopholes in a surface shelter or a periscope in the roof of a cave shelter. The upper end of the periscope should be camouflaged.

(6) *Priority order of construction.*—In the ideal case there should be a sufficient number of shelters in a position to provide cover for the normal defensive garrison, but due to the time and labor involved as well as other considerations, this is generally impossible. Hence the question arises as to priority for shelter construction. Order of priority depends upon local conditions and cannot be stated definitely. In general, machine guns, observation posts, and command personnel should receive first consideration.

(7) *Application of types.*—(a) Due to time element and construction difficulties, the light or splinterproof shelter is the type usually employed during early stages of organization of the ground in mobile warfare. Necessity for shelter

becomes greater as a condition of stabilization develops and details of the position become known to the enemy.

(b) Splinterproof shelters are desirable along important communication trenches for protection of carrying parties, reliefs, litter bearers, and others who may be caught in a bombardment.

(c) Light shelters are of value in consolidating positions.

(d) In rear parts of the defended area, larger and deeper shelters are both permissible and economical. These usually accommodate one or two squads or a platoon, but company and even battalion shelters may be used in certain cases. They may be developed from the light or splinterproof shelters constructed in emergency. Heavy shellproof and cave shelters are used only in stabilized situations.

(8) *Requirements for shelter in advanced positions.*—(a) Shelters in advanced lines should be—

1. Well distributed, placing the troops close to their combat positions.
2. Constructed without going to great depths in order to provide for ease of exit.
3. Provided with a direct and easy exit (even at some sacrifice of cover).
4. Of small capacity (from 2 to 12 men).
5. Of a type that can be constructed rapidly.
6. Concealed as thoroughly as possible.

These requirements limit the type to the splinterproof or the light shelter.

(b) Construction of light shelters is usually started by Infantry holding the front lines. They are located in individual rifle pits or in trenches resulting from organizing the position. To prevent caving they are lined with logs or timber, depending upon material available. They should have at least 4 feet of cover.

(9) *Requirements for shelters in rear positions.*—Shelters in rear positions may be larger and deeper than those at the front. The occupants have more time to emerge after warning of attack has been received, and can occupy their positions more deliberately. They can be given maximum overhead cover in order to withstand bombardment of heavy shells, giving troops occupying them necessary rest and feel-

ing of security. These shelters are built entirely below ground if underground water conditions permit. They are carefully hidden from enemy aerial observation. Depending on the situation, construction of these shelters may be by engineers, other troops, civilians under military control, civilian contractors, or any combination of these.

*b. Technical considerations and requirements.*—(1) The *subsurface conditions*, such as extent and character of underlying rock, position and thickness of impervious and water-bearing strata, and amount of water to be controlled.

(2) *Facilities available*, including time, personnel, tools, material, and transportation.

(3) *Facility of exit.*—In order that a shelter may perform its proper function, it must provide means for rapid egress of its occupants. This is particularly important in the case of shelters located near the front where troops must be able to make their exit and occupy their fighting positions after enemy bombardment has ceased and before assault troops enter defensive works.

(a) Facility of exit is secured by designing shelters of small capacity, a minimum depth below ground, and having unrestricted entrances.

(b) Large shelters are provided with at least two entrances and preferably with a third for emergency use. This supplementary exit should emerge in a different trench from the other two, or at least at some point well concealed or camouflaged, permitting the garrison to escape and launch a counterattack on an enemy attacking the main entrance. Entrances should be spaced to avoid the danger of one shell burst blocking two of them (a minimum of 40 feet apart and separated by an angle in the trench). Large systems of cave shelters should be constructed to provide one entrance for every 25 men.

(4) *Drainage, ventilation, and gasproofing.*—(a) *Drainage.*—In the case of surface shelters drainage presents few difficulties. In the case of deep shelters it sometimes becomes a complex problem which includes—

1. Exclusion of surface water from the entrance.
2. Exclusion of seepage from the interior.
3. Removal of water that has collected in the interior.

For further details, see paragraph 59.

(b) *Ventilation*.—In surface or cut-and-cover shelters ventilation presents no great problem, but in the cave shelter with its underground chambers it becomes of vital importance. Ventilation is provided by entrances and by openings through the roof, all so equipped that they can be closed to exclude gas. For further details see paragraphs 60, 61 and 62.

(c) *Gasproofing*.—It should be possible to make all shelters and particularly those below ground gastight. A shelter not in use should be sealed to exclude gas, otherwise casualties may occur when it is again used. For details of gasproofing, see paragraph 62.

■ 53. OVERHEAD COVER.—*a. Thickness*.—Thickness of overhead cover is governed by the—

- (1) Character of covering material.
- (2) Artillery fire to be resisted.
- (3) Arrangement of successive layers.
- (4) Interior construction of the shelter.

*b. Materials employed*.—Materials for overhead cover fall into two main classes:

(1) *Virgin soil (in undisturbed condition) existing in the case of cave shelters*.—This is the best form of cover if sufficient thickness can be provided. However, particularly in soft ground, it may be reinforced by addition of a bursting layer consisting of any of the following materials:

- (a) Concrete slab bursters, described in *d* below.
- (b) Broken stone or brick, layer at least 18 inches thick.
- (c) Layer of I-beams, reinforced concrete beams, or rails set on edge and firmly wired together.

(2) *Artificial substitutes used in all forms of cut-and-cover and surface shelters*.—Artificial substitutes in addition to earth are employed in construction of cut-and-cover and surface shelters. Protection is usually secured by alternating layers of various resisting materials, but to acquire a degree of protection equal to that of the deepest cave shelters would cause the mound to project too far above the ground and would involve too great a quantity of material. Consequently cut-and-cover and surface shelters (other than those of con-

crete) are designed for protection against calibers less than 8 inches.

c. *Thickness of cover for various shells.*—(1) Table XXVI may be used for computing thickness of cover required for various shells under different ground conditions (see sec. I).

TABLE XXVI.—*Minimum thickness in feet of overhead cover*

Nature of cover	Size of projectile, inches									
	Rifle, or machine-gun fire, shell fragments	3	4	6	8	10	12	16	18	
Reinforced concrete.....		1.0	2.4	3.4	5.0	6.0		7.0		
Masonry, solid: Brick, stone, plain concrete.....		1.5	3.6	5.1	7.5	9.0		11.0		
Logs, 8-inch minimum diameter wired.....		2.0	4.8	6.8	10.0	12.0				
Crushed stone.....		3.5	8.4	11.0	17.5	21.0				
Tamped or packed earth.....	1.0	7.5	18.0	25.5	37.5					
Loose earth.....	3.0	10.0	24.0	34.0	45.0					
<hr/>										
Cave shelters:										
Sandstone or granite.....		2.0	6.0	8.0	10.0	13.0	14.0	17.0	24.0	
Soft limestone.....		3.0	9.0	11.0	15.0	20.0	21.0	27.0	36.0	
Undisturbed earth.....		5.0	12.0	17.0	25.0	30.0	32.0	40.0	48.0	

Figures to the right of and below the heavy line are for shelters that would normally be constructed by cut-and-cover methods; those to the left are normally for surface shelters. The dividing line is not fixed as determination of type depends on location, materials, and labor and time available.

(2) Figures in the table are for material of uniform character from top of the chamber to within a foot of the surface. If a tamping layer of soft material overlies rock, total depth from surface to chamber roof must be increased by effective depth of tamping layer.

d. *Arrangement and number of layers.*—(1) Strength of overhead cover depends as much on manner in which various layers of covering are arranged as on character of materials

of which it is composed. Proper arrangement of layers is shown in figure 120.

(2) Component layers consist of the following:

(a) *Bursting layers* must be provided for all cut-and-cover and surface shelters and over entrances to cave shelters to cause force of the explosion to be expended upward due to lack of tamping effect. They are effective against shells with instantaneous and short-delay fuses. The bursting layer may be made from any of the materials listed in *b* above, should

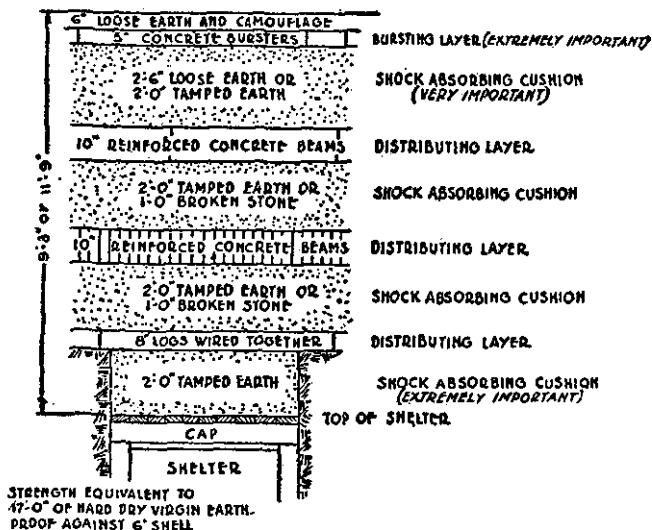
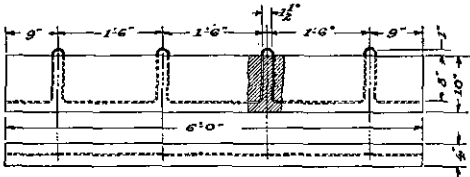

FIGURE 120.—Diagrammatic section showing name, character, and correct manner of placing successive layers of artificial cover.

be in the form of an umbrella, and should extend to a point well beyond a line drawn tangent to the bottom edge of the shelter at an angle of  $45^\circ$  to the vertical. Bursting layers should be covered with not more than 9 inches of earth which should preferably be sodded. This serves to conceal the shelter, prevents flying splinters, and reduces disintegration of the burster layer by several hits in the same place. Figure 121 shows details of standard reinforced concrete burster.

(b) *Distributing layers* of logs firmly wired together, steel I-beams, rails, or concrete beams set on edge are essential to distribute strain and to prevent penetration of shell fragments. These layers are placed in accordance with principles illustrated by the example in (5) below. Weight of overhead



Made in lengths of 6 ft. 12 ft. and 15 ft.  
 Weight 35<sup>+</sup> per ft.  
 For 6'0" beam 11 ft.  $\frac{1}{2}$ " dia. rod or #6 wire  
 " 12'0" " 22 " " " " " " " " " " " "  
 " 15'0" " 28 " " " " " " " " " " " "

Concrete Beam

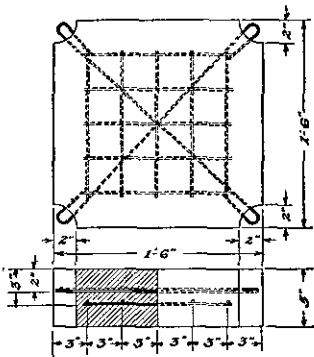

Weight 145<sup>+</sup>  
 19 ft. of  $\frac{1}{2}$ " dia. rod or #6 wire

Concrete Burster

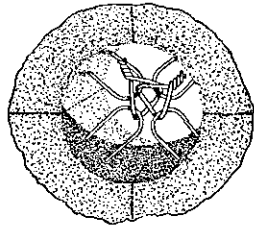

Burster Assembly

FIGURE 121.—Standard reinforced concrete burster and beam.

cover is carried by the lowermost distributing layer which rests on berms left in the natural soil. Thus weight of cover and shock of explosion are transmitted to these berms rather than to the interior framework. Details of standard reinforced concrete beams are shown in figure 121.

(c) *Shock-absorbing cushions* are essential beneath the bursting layer, over the top of the inner framework, and between the distributing layers. The one beneath the bursting layer may be of loose or tamped earth, the others of tamped earth or broken stone, except the one immediately above the shelter which should be of tamped earth. Facines (see par. 37d) are sometimes substituted for tamped earth with satisfactory results. The omission of these shock-absorbing cushions is one of the most frequent causes of failure of cut-and-cover shelters. The top and bottom cushions are the most vital and under no circumstances should they be omitted.

(3) Proper interior support is essential to secure the full value of overhead cover. The clear span of the interior framework must not exceed 6 feet 6 inches for cut-and-cover or 8 feet for cave shelters. The figures for cover are based on the use of these spans and upon the use of standard size timbers properly supported. If these are not used, the cover provided if based on table XXVI may be insufficient.

(4) The shock or blow of the explosion strikes the stiff distributing layer and is spread over the cushion; the latter absorbs part of it and further spreads its effect before it strikes the next distributing layer, where it is again spread over a wider area until finally when the blow reaches the inner shell of the shelter chamber it is so distributed and absorbed as to be sustained without rupture.

(5) An example of the computation for cover to protect against 6-inch shell using several classes of material, similar to that used in figure 120, is given. It is assumed that the material available for cover consists of 8-inch diameter logs, standard bursters and beams, and earth, the latter to be tamped or packed. With the general number and arrangement of layers determined, it is desired to find thickness of earth that is to be distributed in the cover. From table XXVI the total cover for tamped earth alone is 25.5 feet. Any other material except loose earth reduces this figure by the ratio of thickness used to thickness required if the material were to be used alone. Thus reinforced concrete would be required in thickness of 3.4 feet if used alone, but, as 0.415 foot only is used in one layer of concrete bursters, the layer has a value equivalent to  $\frac{.415}{3.4} = 12.2$  percent of the total thickness



for the material used alone. The following values are used in the above manner in computation of percentage equivalence of the whole thickness for each material used, except earth:

2 layers standard concrete beams.....	0.83 foot thick (or high)
1 layer standard concrete bursters.....	.415 foot thick
1 layer of 8-inch diameter logs.....	.66 foot thick

Then the percent of total cover allocable to these materials is—

		Percent
Concrete beams .....	$(0.83 \div 3.4) \times 2 =$	48.8
Concrete bursters .....	$0.415 \div 3.4 =$	12.2
Logs.....	$0.66 \div 6.8 =$	9.7
		70.7
Percent of cover allocable to tamped earth.....		29.3
		100.0

$25.5 \times 29.3$  percent = 7.5 feet or three layers of 2 feet and one of 1½ feet thick.

*e. Concrete as overhead cover.*—(1) Concrete, either plain or reinforced, is a most effective shell-resisting material.

(2) There are apparent drawbacks to the use of concrete in active warfare, but some may be more apparent than real. These drawbacks are—

(a) Too many workers concentrated in a small area.

(b) Construction time is long when portland cement is used.

(c) Cement at the front is likely to deteriorate; it is necessary and difficult to keep it dry.

(d) Due to interruptions, it is often impossible to obtain a continuous pour of concrete and a truly monolithic shelter.

(3) Use of high early strength cement concrete in place of standard portland cement reduces the construction time, and is therefore especially suited to war construction because the former attains about 75 percent of its full strength in 24 hours, against 24 days for portland cement concrete; it also permits work at relatively lower temperatures. The final forms

(beams, slabs, etc.) may be removed if necessary about 30 hours after pouring high early strength cement concrete.

(4) Where amount of concrete to be poured is relatively large and other conditions, as hostile interference and observation, do not control, concrete mixing should always be done by power mixers if they can be obtained. The mixing of concrete by machinery should be made the rule even in small batches of a few yards to reduce time of operation and number of men necessary.

(5) Construction time includes the whole period of work from commencement of labor to the time when the structure becomes effective for use. The factor of transportation of materials may have a delaying effect if amounts required are excessive. Comparing shelters of equal capacity and resistance, necessary transportation for materials for a concrete shelter is in most cases considerably less than for a shelter constructed of lumber, logs, rails, concrete beams, and crushed stone.

(6) Existing conditions may cause cement to deteriorate. The ability to protect cement from deterioration increases in proportion to the distance from the front line.

(7) Liability to interruptions in pouring increases in direct proportion to proximity to the front line. The shortened period of construction due to use of machinery on a well-coordinated job lessens importance of this drawback.

■ 54. STANDARD CONSTRUCTION MATERIALS.—*a. General.*—Experience has developed standard materials for use in the construction of protected shelters which are distributed by engineer agencies. Their use results in economy of material and labor. The construction materials described are given as a guide for establishing standard materials. Standard reinforced concrete beams and bursters have already been described in paragraph 53 and figure 121.

*b. Timbers.*—Cases will often occur where round timbers cut near the site will have to be used in lieu of dimensioned lumber. The following table gives a number of standard size sawed timbers and the round timbers which should be used in lieu of them.

TABLE XXVII.—Equivalent timbers used as beams

Sawed timbers, width X depth	Area (square inches)	Equivalent round timber diameter in inches	Area (square inches)
1 by 4	4	3	7.1
1½ by 6	9	4½	15.9
2 by 4	8	4	12.6
2 by 6	12	5	19.6
2 by 8	16	6	28.3
2 by 10	20	7	38.5
3 by 3	9	3½	9.6
3 by 6	18	6	28.3
3 by 10	30	8	50.3
3 by 12	36	9	63.6
4 by 4	16	5	19.6
5 by 10	50	10	78.5
6 by 6	36	7	38.5
8 by 8	64	10	78.5
8 by 12	96	13	132.7
8 by 14	112	14	154.0
8 by 16	128	15	177.0
12 by 12	144	14	154.0

NOTE.—The equivalent round timbers are also safe as columns. In making up the table primary consideration was given to resistance to bending. However, in every case the round timber will resist more vertical shear than the timber of rectangular cross section to which it is equivalent.

*c. Corrugated steel arches.*—Arches are fabricated from heavy corrugated steel (fig. 122). They are classified as to name and size as—

- (1) *Two-man*, for splinterproof and light shelters.
- (2) *Light elephant*, for splinterproof and light shelters.
- (3) *Elephant*, for light shellproof shelter.

■ 55. SURFACE.—*a. From the standpoint of construction*, surface shelters fall into the following groups:

- (1) Surface shelters concealed in woods or behind reverse slopes.
- (2) Shelters constructed by reinforcing buildings.
- (3) Reinforced concrete shelters above ground.
- (4) Small light shelters for protection of ammunition and stores.

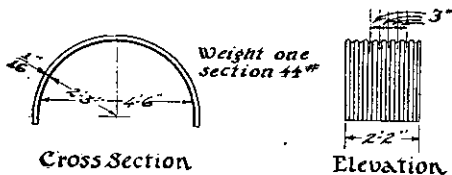

Two Man

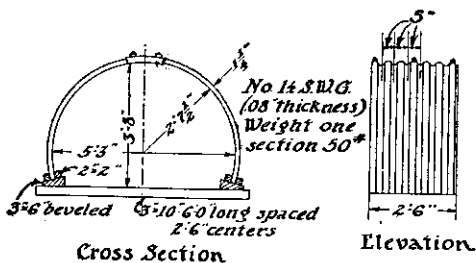

Light Elephant

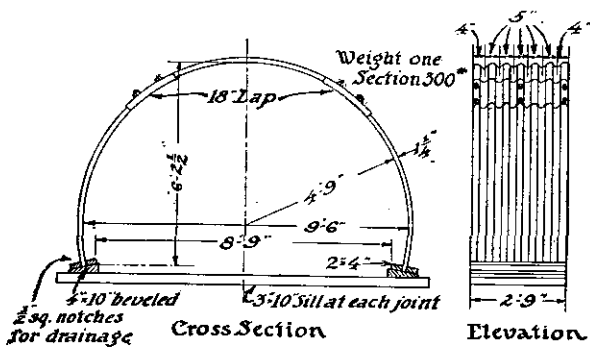

Elephant

FIGURE 122.—Corrugated steel arches.

b. *Surface shelters concealed in woods or behind reverse slopes.*—(1) This form varies from the hasty splinterproof type to the light shellproof type.

(2) The hasty splinterproof type is usually of an improvised nature built out of the materials at hand, for example, a shed built with logs and corrugated iron covered with a light layer of earth. No standard form of construction can be specified.

(3) A form of light shelter with material list is shown in figure 123. It has a capacity of 12 men and protects against 3-inch shells. Standard elephant corrugated steel (see fig. 122) is used with a covering of 1 foot each of concrete and sandbags, 1½ feet of crushed stone, and 9 inches of tamped earth. The ends consist of wood partitions having doors, and are protected to the same extent by carrying the cover around the ends. The bunks are made in the standard way

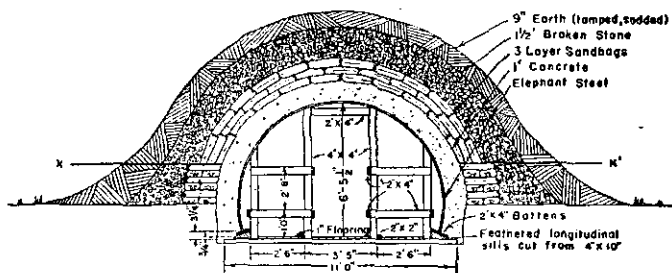

When necessary to place floor at level below water-line it should be concrete and drained to a sump.

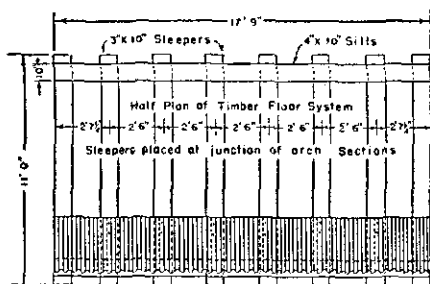

PLAN

FIGURE 123.—Corrugated steel surface shelter, capacity 12 men.

with some alteration for roof curvature. This type is described as an example, but if the specified materials are not available, other material can be substituted for the cover and the lining may be of timber. The concrete is difficult to pour but may be done by first building the covering materials up to the line shown by x-x' in figure 123 and using a very stiff mix and improvised exterior form work immediately above line x-x'.

TABLE XXVIII.—*Material list, corrugated steel surface shelter (fig. 123)*

Item	Size	Unit	Quantity	Weight (pounds)
Corrugated arch section, complete.	Elephant.....	Each.....	7	2,100
Post, bunk, one cut....	4 by 4 by 13 ft.....	do.....	4	275
Do.....	4 by 4 by 10 ft.....	do.....	4	215
Sill, feathered from 4 by 10 inches.	4 by 10 by 6 ft.....	do.....	3	240
Sleeper.....	3 by 10 by 11 ft.....	do.....	8	880
Bunk frame, crosswise, 3 cuts.	2 by 4 by 12 ft.....	do.....	4	130
Bunk frame, lengthwise, to cut.	Standard.....	do.....	12	385
Batten.....	2x4x12 ft.....	do.....	6	190
Sprag, cross, and longitudinal.	do.....	do.....	4	130
Nailing strip, post....	2 by 2 by 12 ft.....	do.....	3	50
End lumber.....	2 by 6 by 8 ft.....	do.....	24	770
Flooring.....	1 inch.....	Square ft.....	150	600
Wedges.....	Standard.....	Each.....	20	30
Wire netting.....	36 inches wide, 12 inch mesh.	Linear ft.....	78	20
Wire, bunks.....	No. 12.....	do.....	320	10
Staples.....	3/8, No. 9.....	Pound.....	6	6
Nails.....	Tenpenny.....	do.....	5	6
Do.....	Twentypenny.....	do.....	6	5
Cement (1-2-4 concrete).	In bags.....	Bag.....	100	9,500
Crushed stone or gravel.	.....	Cubic yard.....	1 53	143,100
Sand.....	.....	do.....	8	21,600
Sandbags.....	Standard.....	Each.....	1,200	600
Total.....	.....	.....	.....	181,142

<sup>1</sup> Includes 15 cubic yards for concrete. Remainder may be alternated by brick-bats if available.

## WEIGHTS

Items	Pounds	Tons
Lumber.....	3,895	1.95
Steel.....	2,100	1.05
Cement.....	9,800	4.90
Crushed stone or gravel.....	143,100	71.55
Sand.....	21,600	10.80
Miscellaneous.....	647	.32
Total.....	181,142	90.57

*c. Shelters constructed by reinforcing buildings.*—When protected shelters are constructed inside of buildings they should generally be proof against at least 6-inch shell because buildings form a favorite target for artillery. Eight feet of artificial cover consisting of dry walls (large slabs of rock, masonry, or concrete), timbers or poles wired together, and undisturbed building walls give this protection. Where possible the chamber of the shelter should be placed in an excavation below the ground level of the building and the covering material supported on berms, in which case it becomes a cut-and-cover type. Figure 124 shows a room in a building used as a shelter, the cover being placed on the floor above and the floor stringers shored up. This type may be used where conditions do not permit cut-and-cover construction.

*d. Reinforced concrete shelters above ground.*—Shelters of this type may be used to protect personnel in relatively large numbers provided it is practicable to assemble the material necessary for construction. The design of these shelters follows accepted practice for reinforced design so far as placing reinforcements is concerned. Ordinarily they may be used in connection with emplacements for protection of the crew on duty at the emplacement and for observation and command posts under proper conditions. They should be provided with a burster course extending on all sides of the shelter to prevent penetration and explosion of projectiles under the structure. The whole structure should be covered with sod for concealment.

■ 56. ARTILLERY AMMUNITION.—*a. General.*—(1) The essential requirement of an ammunition shelter is that it be made waterproof.

(2) Cover to give protection from shell fire is not essential although concealment is desirable always. If overhead cover were to be secured by depth below the surface, storage and service of ammunition would be impracticable; if secured by building above the surface, concealment would be impracticable.

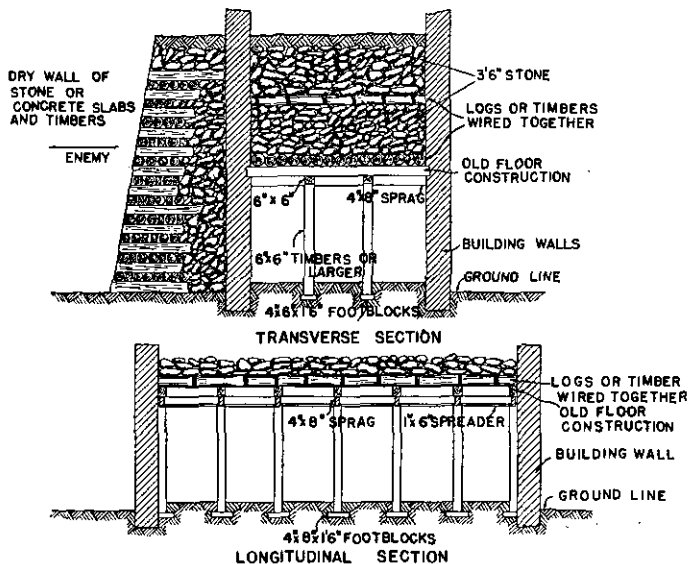

FIGURE 124.—Shelter in reinforced building.

(3) It is desirable that ammunition be stored below the level of surrounding ground so that if a direct hit is obtained destructive effect of the explosion will be minimized. In cases where ground water limits depth of excavation, irregularities in the surface of the ground are utilized to obtain a certain amount of natural cover.

(4) Amount of ammunition for which shelters are provided depends on the tactical situation, the minimum being



that amount which is normally carried in vehicles of the battery.

*b. Hasty position.*—(1) In a hasty position time seldom permits construction of shelters for ammunition. Essential requirements are to keep ammunition dry and well concealed.

(2) It always is advisable to place some sort of platform under ammunition. If this is not done the location should be drained. The platform is made of brush, logs, planks, or similar material, and the piles covered with paulins or improvised material.

*c. Deliberate position.*—(1) In a deliberate position advantage is also taken of the materials available locally. Ammunition shelters do not require elaborate construction, and those shown in the figures 125 and 126 illustrate types that may be used.

(2) The shelters are located in rear of the piece or at some favorable point on the flank. Shelter for some ammunition is constructed at the emplacement. Additional shelters are constructed farther in rear for a reserve supply. Shell, powder charges, and fuses always are stored in separate places. For separate-loading ammunition the shelter for shell preferably is located to the left of the emplacement.

(3) *Types.*—(a) A corrugated steel arch shelter erected in the side of a trench is illustrated in figure 125. This shelter holds 50 rounds of ammunition or 8 boxes of fuses.

(b) Elephant steel shelters preferably are used for storing 155-mm or larger shell. These are waterproof, easy to erect, and the materials for them usually available. They are built to any size by increasing number of sections. The height is sufficient to enable a man to move around freely inside. The construction of an elephant steel shelter for 155-mm ammunition is illustrated in figure 126.

■ 57. **CUT-AND-COVER.**—*a. Excavation for cut-and-cover shelters* reaches practical limits at a depth of cut of about 12 feet below the surface. All shelters with a base to be placed lower than this should be constructed by mining methods (cave shelters).

*b. Splinterproof.*—(1) One of the simplest forms of splinterproof cut-and-cover shelters for use in mobile warfare is shown in figure 127. This type is frequently constructed

by the infantry soldier in the advanced lines. He must be trained in performing the task as his natural tendency is to dig a niche in the forward interior slope of the trench which is the proper location for the shelter, but the result

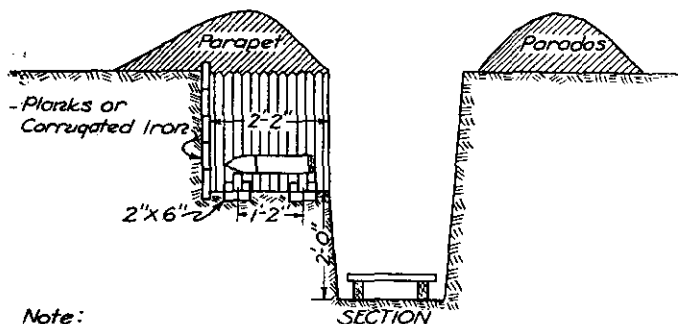

Note:

Place thin boards or brush between layers of shell or place alternate layers with base and point to front

Top of Parapet—

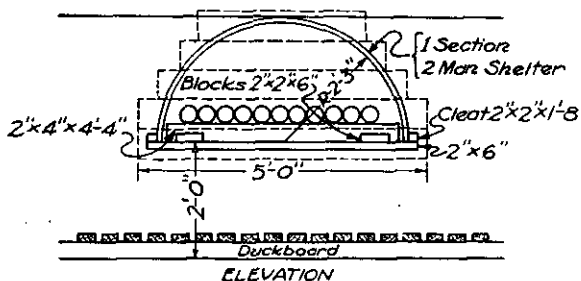

FIGURE 125.—Corrugated steel arch shelter for 75-mm ammunition, is an unsupported recess which quickly caves under effect of shell fire and weather conditions.

(2) *Construction*.—An open excavation is made closely following dimensions given in figure 127. The ceiling should be at ground level or slightly below, and the logs rest on

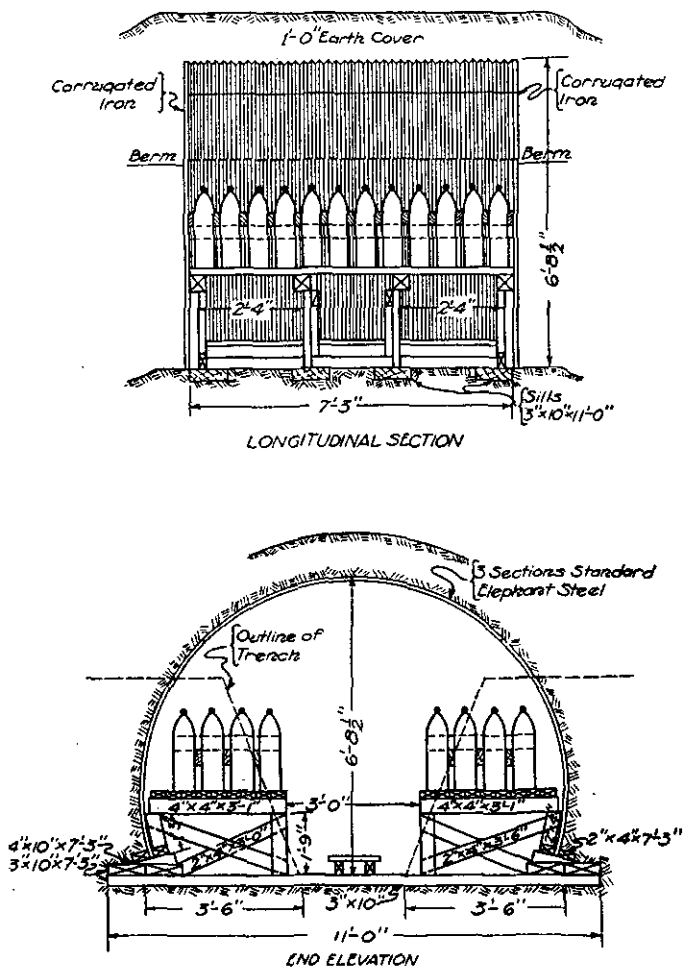

FIGURE 126.—Elephant steel shelter for 155-mm ammunition.

berms of virgin earth which should be at least 18 inches wide. Logs should be not less than 6 inches in diameter and firmly wired together. Earth is then backfilled and original appearance of the parapet restored. The shelter may be made waterproof by the use of corrugated iron or tar paper.

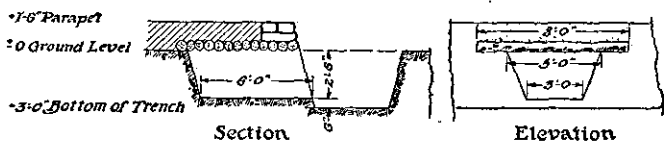

FIGURE 127.—Splinterproof shelter.

TABLE XXIX.—Material list, splinterproof shelter (fig. 127)

Item	Size	Unit	Quantity	Weight (pounds)
Logs, roof.....	6-inch diameter by 8 feet.	Each.....	13	1,000
Wire.....	No. 12.....	Linear foot..	100	3
Sandbags.....	Standard.....	Each.....	30	15
Total weight.....				1,018

(3) *Steel arch.*—The two lighter types (two-man and light elephant) of corrugated steel arch shown in figure 122 are especially useful in consolidating captured trenches after an attack in trench warfare. Splinterproof cover can be obtained rapidly by placing several sections in captured trenches so as to form a tunnel and shoveling earth on top and sides. At least 4 feet of loose earth cover should be provided.

*c. Light shelters.*—(1) Types of light shelters proof against 3-inch shells with material list included are shown in figures 128 and 129, and tables XXX and XXXI. These may be of either cut-and-cover or cave construction depending on soil conditions.

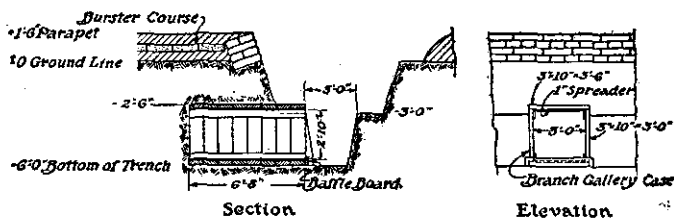

FIGURE 128.—Light shelter, timber.

TABLE XXX.—Material list, light shelters (fig. 128)

Item	Size	Unit	Quantity	Weight (pounds)
Cases, gallery	Branch	Each	8	1,200
Batten	1 by 4 by 14 feet	do	2	35
End lumber	1½ by 6 by 14 feet	do	2	85
Wedges	Standard	do	16	25
Baffle board	2 by 10 by 4 feet	do	1	25
Nails	Twentypenny	Pound	5	5
Bursters	Standard	Each	20	2,900
Wire	No. 12	Linear feet	20	1
Sandbags	Standard	Each	30	15
Total weight				4,291

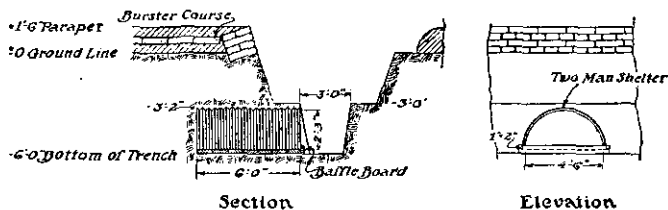

FIGURE 129.—Light shelter, corrugated steel.

TABLE XXXI.—Material list, light shelter (fig. 129)

Item	Size	Unit	Quantity	Weight (pounds)
Floor	3 by 10 by 6 feet	Each	6	360
End	do.	do.	3	180
Baffle board	2 by 10 by 6 feet	do.	1	40
Floor strips	1 by 2 by 12 feet	do.	1	8
Corrugated arches	Two-man	do.	3	132
Nails	Twenty penny	Pound	2	2
Bursters	Standard	Each	20	2,900
Wire	No. 12	Linear foot	20	1
Sandbags	Standard	Each	30	15
Total weight				3,638

(2) *Construction*.—In firm soil these types usually can be constructed by digging into the face of the trench without cutting all the way to the surface of the ground. In loose soil it is necessary to make an open excavation and backfill. Both types of shelter must closely fit the excavation which is accomplished by cutting the excavation accurately to size and by ramming dirt into any space outside the frame. The floor should slope slightly toward the trench to provide drainage, and a baffle board to exclude water entering from the trench should be placed as indicated in the figure. The burster course is placed by excavating a portion of the parapet, placing the course, and backfilling so that original appearance of the parapet is restored.

*d. Light shellproof shelters*.—(1) *Classes*.—Cut-and-cover shelters of the light shellproof type are grouped into three classes, according to manner of interior construction.

(a) *Timbered shelters* may be constructed by using standard materials sent forward from engineer supply points or of round timbers procured near the site.

(b) *Standard corrugated steel arches* are quickly and easily assembled and are recommended for interior construction of cut-and-cover shelters whenever they can be obtained. Corrugated steel sections when bolted together form watertight arched support.

(c) *Concrete shelters* should be constructed with reinforcement to obtain economy of cement and aggregates. When time, labor, material, and transportation are available, they offer superior facilities from the standpoint of protection, living conditions, and adaptability.

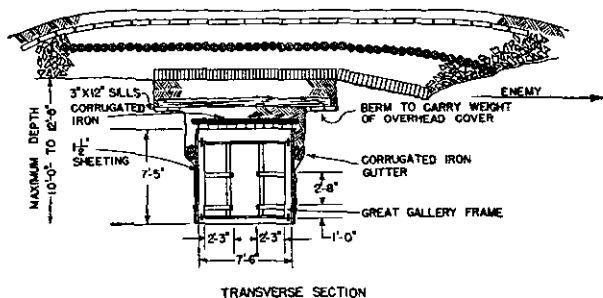
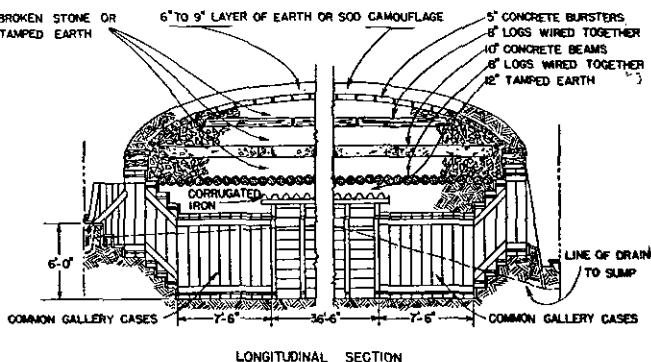

FIGURE 130.—Cut-and-cover, timber shelter.

(2) *Cover*.—Type and thickness of cover required for a cut-and-cover shelter depend on kind of material available and on location and use to be made of the shelter. Protection is provided as described in paragraph 53 which gives thickness of cover and arrangement of the successive layers.

(3) *Excavation.*—The cut to contain the shelter should be limited to a maximum depth of about 12 feet. If it is necessary to go below this depth, greater economy of labor and material is obtained by construction of cave shelters. The sides of the cut should be excavated with as little batter as possible, leaving only sufficient clearance for placing frames and sheeting.

(4) *Berms.*—These must provide for carrying entire weight of the artificial cover which must never rest on the interior framework of the shelter.

(5) *Timbered shelters.*—(a) A cut-and-cover shelter having an interior lining of timber is illustrated in figure 130. The capacity of the shelter is 24 men and it protects against 6-inch shell.

TABLE XXXII.—*Material list, cut-and-cover timber shelter (fig. 130)*

Item	Size	Unit	Quantity <sup>1</sup>	Weight (pounds)
Frames, gallery.....	Great.....	Each.....	13 (2)	4,875
Post bunk.....	4 by 4 by 6 feet 6 inches.	do.....	14 (2)	485
Sprag, top and bottom, sides.	3 by 8 by 11 feet.....	do.....	12 (2)	1,055
Sills, berm.....	3 by 12 by 12 feet.....	do.....	17 (2)	2,450
Baffle board.....	2 by 12 by 3 feet 6 inches.	do.....	1	30
Stair stringers.....	2 by 10 by 10 feet.....	do.....	1	65
Stair treads.....	2 by 10 by 12 feet.....	do.....	1	80
Brace, diagonal.....	2 by 6 by 8 feet.....	do.....	1	30
Sheeting, top.....	2 by 6 by 12 feet.....	do.....	50 (8)	2,400
Bunk frame, cross-wise, to cut.	2 by 4 by 8 feet.....	do.....	7 (1)	145
Bunk frame, length-wise.	2 by 4 by 7 feet.....	do.....	48 (8)	895
Sprag, top, center.....	2 by 4 by 11 feet.....	do.....	6 (1)	175
Risers.....	1½ by 10 by 3 feet 6 inches.	do.....	9	160
Headers.....	do.....	do.....	8	140
Sheeting, sides.....	1½ by 6 by 12 feet.....	do.....	100 (15)	3,600
Sheeting, ends only..	1½ by 6 by 10 feet.....	do.....	15	450
Stair risers.....	1 by 10 by 3 feet.....	do.....	3	30

<sup>1</sup> Figures in parentheses show quantities required for unit length of 6 feet.



TABLE XXXII.—Material list cut-and-cover timber shelter  
(fig. 130)—Continued

Item	Size	Unit	Quantity †	Weight (pounds)
Batten.....	1 by 6 by 10 feet.....	do.....	10	200
Revetting boards, to cut.	do.....	do.....	4	80
Wedges.....	Standard.....	do.....	184 (20)	260
Cases, gallery.....	Common.....	do.....	27	5,940
Flooring.....	1 inch.....	Square foot.....	90 (15)	360
Corrugated iron, galvanized.	No. 20, 8 feet by 24 inches.	Sheet.....	24 (4)	691
Wire netting.....	36 inches wide, 2-inch mesh.	Linear foot.....	156 (26)	40
Wire, bunks.....	No. 12.....	do.....	480 (80)	12
Staples.....	¾ No. 9.....	Pound.....	12 (2)	12
Nails.....	Fortypenny.....	do.....	12 (2)	12
Do.....	Twentypenny.....	do.....	20 (4)	20
Do.....	Tenpenny.....	do.....	10 (2)	10
Sandbags.....	Standard.....	Each.....	100	50
Bursters.....	do.....	do.....	750 (88)	108,750
Wire, binding.....	No. 12.....	Linear foot.....	3,500 (400)	105
Beams, concrete.....	Standard.....	do.....	3,400 (380)	129,200
Logs.....	8-inch diameter.....	do.....	3,000 (360)	50,400
Crushed stone, if used.		Cubic yard.....	300 (20)	810,000
Total weight.....				1,123,207

† Figures in parentheses show quantities required for unit length of 6 feet.

## WEIGHTS

Item	Pounds	Tons
Lumber.....	23,905	11.95
Concrete beams and bursters.....	237,950	118.97
Logs.....	50,400	25.20
Crushed stone.....	810,000	405.00
Miscellaneous.....	952	.48
Total weight.....	1,123,207	561.60

(b) The maximum spacing of frames is 3 feet, but where timber is available the spacing should be at 2-foot centers. The maximum span should not exceed 6 feet 6 inches. Where exceptional strength is more essential than large capacity, shorter spans should be used. All frames must be braced with distance pieces both at the top and bottom at the sides and at the top in the center. The sprags must be placed to bear both on the posts and on the caps or sills as the case may be.

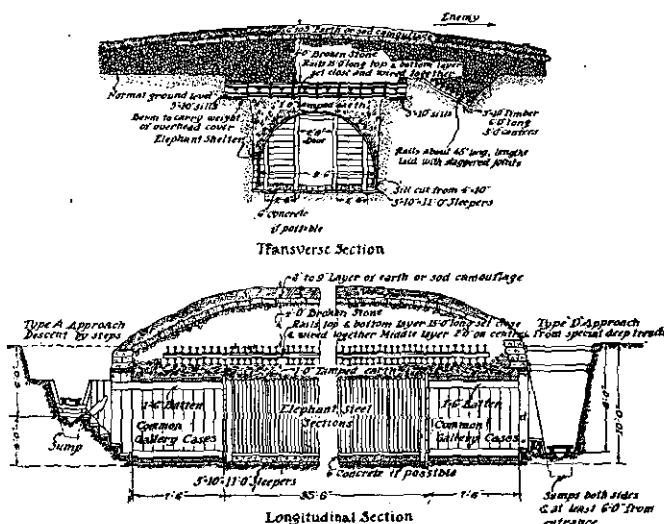

FIGURE 131.—Cut-and-cover, corrugated steel.

(c) Long boards instead of standard sheeting should be used in sheeting this type. The boards should be given full bearing on the posts, and the joints should be staggered. Nails should be used where possible. With standard sheeting overlap to the full width of the frame to get full bearing. Corrugated iron is placed on top of the chamber, and side gutters are fastened to the outside as indicated in the figure. These may be of corrugated iron or of wood. They lead to sumps in the trenches as shown by the dotted line.

(d) Without proper framing and bracing, the full strength of the timber is not developed and the resistance against explosions is only a fraction of that afforded by the same material properly used.

(6) *Corrugated steel shelters.*—(a) A cut-and-cover shelter having an interior lining of corrugated steel is illustrated in figure 131, with a material list in table XXXIII. Capacity of the shelter is 24 men, and it protects against 6-inch shell. Bunks are not shown in the drawing, but they are covered in the material list in the table. They are arranged as in the surface shelter (fig. 123).

TABLE XXXIII.—Material list, cut-and-cover corrugated steel shelter (fig. 131)

Item	Size	Unit	Quantity	Weight (pounds)
Corrugated arch section, complete.	Elephant.....	Each.....	14	4,200
Sill, feathered from 4 by 10 inches.	4 by 10 by 6 feet.....	do.....	6	480
Post, bunk, 1 cut.....	4 by 4 by 13 feet.....	do.....	7	485
Do.....	4 by 4 by 10 feet.....	do.....	7	375
Sleeper.....	3 by 10 by 11 feet.....	do.....	15	1,650
Sills for rails.....	3 by 10 by 12 feet.....	do.....	24	2,880
Baffle boards.....	2 by 12 by 3 feet 6 inches.	do.....	1	30
Stair stringers.....	2 by 10 by 10 feet.....	do.....	1	65
Stair treads.....	2 by 10 by 6 feet.....	do.....	2	80
Diagonal braces.....	2 by 6 by 8 feet.....	do.....	1	30
End lumber.....	do.....	do.....	24	770
Batten.....	2 by 4 by 12 feet.....	do.....	12	385
Bunk frame, lengthwise to cut.	do.....	do.....	24	770
Bunk frame, crosswise, 3 cuts.	1 by 6 by 10 feet.....	do.....	7	225
Sprag, cross and longitudinal.	2 by 4 by 12 feet.....	do.....	8	255
Nailing strip, post.....	2 by 2 by 12 feet.....	do.....	6	95
Stair risers.....	1 by 10 by 3 feet.....	do.....	3	30
Batten.....	1 by 6 by 10 feet.....	do.....	7	140
Revetting boards.....	do.....	do.....	4	80
Cases, gallery.....	Common.....	do.....	21	4,620
Wedges.....	Standard.....	do.....	124	175

TABLE XXXIII.—Material list, cut-and-cover corrugated steel shelter (fig. 131)—Continued

Item	Size	Unit	Quantity	Weight pounds
Nails.....	Twentypenny.....	Pound.....	15	15
Do.....	Tenpenny.....	do.....	15	15
Staples, bunks.....	3/8 inch, No. 9.....	do.....	12	12
Wire netting, bunks.....	36 inches wide, 2-inch mesh.	Linear feet.....	156	40
Wire, bunks.....	No. 12.....	do.....	640	20
Wire, binding.....	do.....	do.....	4,000	120
Bursters.....	Standard.....	Each.....	750	108,750
Rails, railroad.....	15 feet at 75 pounds (yard).	do.....	172	64,500
Rails, railroad, varied lengths.	At 75 pounds (yard).....	Linear feet.....	880	22,000
Sandbags.....	Standard.....	Each.....	100	50
Cement, for floor if used.....	.....	Bag.....	36	3,528
Sand, for floor if used.....	.....	Cubic yard.....	3	8,100
Crushed stone, for floor if used.....	.....	do.....	7	18,900
Crushed stone, or gravel, fill.	.....	do.....	250	675,000
Total weight.....	.....	.....	.....	918,870

## WEIGHTS

Item	Pounds	Tons
Lumber.....	13,620	6.81
Rails.....	86,500	43.25
Cement.....	3,528	1.76
Sand.....	8,100	4.05
Crushed stone or gravel.....	693,900	346.95
Steel arches.....	4,200	2.10
Bursters.....	108,750	54.38
Miscellaneous.....	272	.14
Total weight.....	918,870	459.44

(b) In construction care should be taken that the foundation is firm and that the arches are not spread at the bottom, thus causing a depression at the top of the arch which materially weakens it and forms joints through which water may

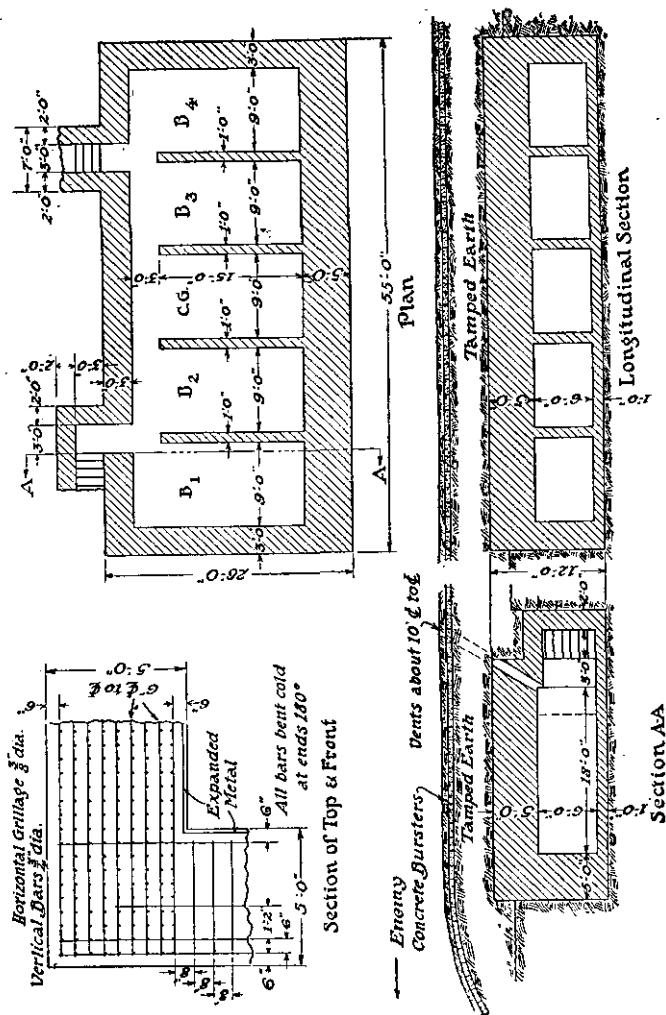

FIGURE 132.—Brigade command post.

seep. If a concrete floor is provided it should be about 6 inches thick.

*e. Heavy shellproof reinforced concrete shelter.*—(1) Most reinforced concrete shelters are of the cut-and-cover type. Use of large concrete shelters is generally limited to reserve positions in stabilized situations.

TABLE XXXIV.—*Material list, brigade command post (fig. 132)*

Item	Unit	Quantity	Weight (tons)
Cement, 1:2:4 concrete (450 cubic yards concrete).	Bags (1 cubic foot).....	2,700	135
Sand.....	Cubic yards.....	200	270
Crushed stone.....	do.....	400	540
Reinforcing metal.....	Pounds.....	40,000	20
Bursters.....	Each.....	1,600	116
Lumber for forms.....	Foot b. m.....	2,400	5
Total weight.....	.....	.....	1,086

(2) Figure 132 illustrates a brigade command post of reinforced concrete proof against 8-inch shells. It is not given as a standard but as an example. Note particularly method of reinforcement. Grillage of bars on 6-inch centers is usually of  $\frac{3}{8}$ -inch rods. Reinforcement spaced at greater distance is of larger size up to  $\frac{3}{4}$  inch. On the inside of the chamber a layer of expanded metal or similar fabric is placed for added protection against spalls. It is better to have a large number of rods of small diameter than a small number of large diameter. The weight of reinforcement runs about 5 pounds per cubic foot of concrete.

(3) The structure may be built without any cover, but cover with a burster course should be added if possible to localize action of a bursting shell. The figure shows cover with a course of bursters.

(4) Approximate quantities for the command post illustrated are shown in the material list.

(5) For floor space requirements of command posts see paragraph 64. For other types of command posts see paragraphs 39c and 58f.

■ 58. CAVE.—*a. Standard construction materials.*—(1) *Cases, gallery, and shaft.*—(a) Cases are designed as a lining, without additional material for use in horizontal galleries, inclined passages, and in shafts driven underground by mining methods (note that frames in (2) below, require sheeting in addition). Dimensions of lumber used in cases vary with size of gallery or shaft (tables XXXV and XXXVI). In horizontal and inclined passages the cases are ordinarily placed in a vertical position and in shafts they are always horizontal. The standard common gallery case using dimensioned lumber, and improvised shaft case using round timbers are shown in figures 133 and 134.

(b) The great gallery case finds little use except in the application to special approaches or passages as in the first-aid shelters. When used in this way the cases may be narrowed to any width desired for economy in excavation without sacrifice of space. The common gallery case is normally used in inclined entrances driven with cases (b (3) (d) below), and in galleries when driven with cases. The use of the branch gallery case provides for construction of the timbered light shelter shown in figure 128. It also fulfills the requirement for ventilation shafts in cave shelters. The half and branch gallery cases serve for machine-gun shafts, for emergency exits, or for access to observation posts.

(2) *Frames, chamber, gallery, and shaft.*—(a) Standard types of frames are shown in figure 135. They are used in horizontal or inclined passages or in shafts to support accompanying sheeting which forms the lining of the passage or shaft. For use in shafts all timbers of a frame should be the same size as given for frame posts. Dimensions are such as to permit a frame spacing of not over 4 feet on centers. When dimension lumber is not available frames can be improvised from round timber.

(b) The chamber frame is designed for use in the rooms or chambers of cave shelters. The posts may be furnished in 6- by 6-inch dimension timber or round logs at least 6 inches in diameter at the small end. If the latter are used,

they must be straight and as free from knots as possible. Caps are 3- by 5-inch steel I-beams 9 feet long, weighing  $9\frac{3}{4}$  pounds per foot. They are held on the posts by standard beam shoes fastened to the posts by spikes or lag screws.

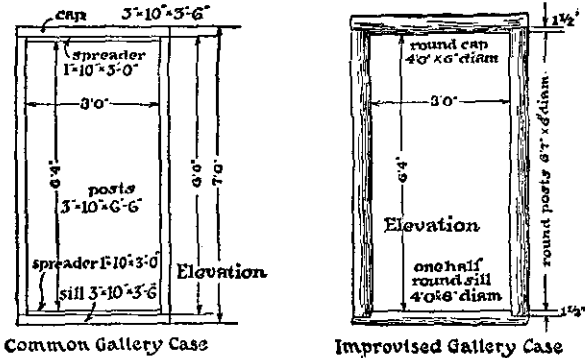

FIGURE 133.—Gallery cases.

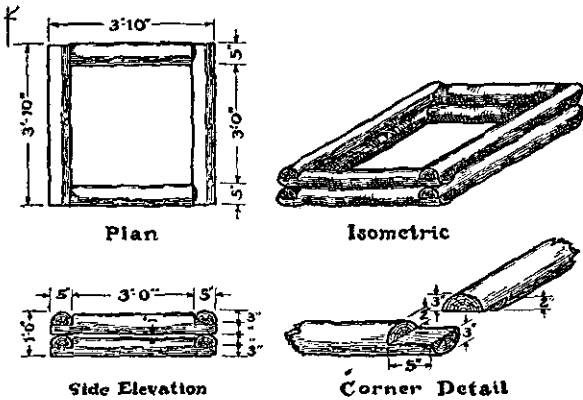
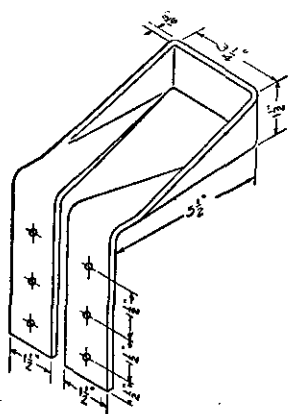

FIGURE 134.—Improved shaft case.

A 2-inch notch is cut in the floor to receive the bottom of the post. In soft ground foot blocks of 3- by 10-inch plank 18 inches long are placed under the posts. In very soft ground such as clay the bottoms of the posts should be sunk from





Detail of Shoe

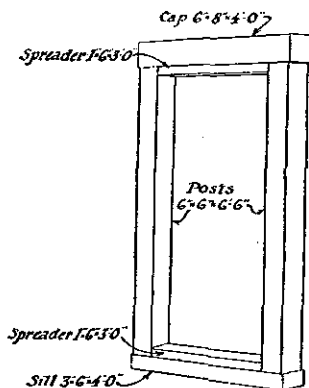

Common Gallery Frame

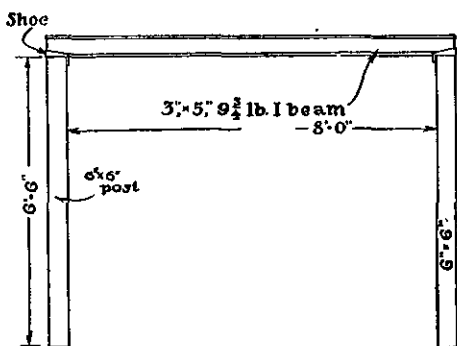

Standard Chamber Frame



End Elev.

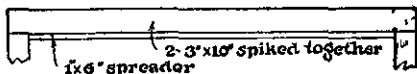

Side Elevation

### Improvised Chamber Frame

FIGURE 135.—Frames for chamber and gallery.

4 to 6 inches into the floor. If steel I-beams are not available 6- by 10-inch timber or two 3- by 10-inch planks spiked together may be used for the cap.

(3) *Dimensions of standard galleries and shafts.*—The following tables give sizes of the various classes of galleries and shafts driven underground by mining methods and include material lists for cases and frames of these classes.

TABLE XXXV.—*Dimensions of standard timbered galleries*

Size of gallery	Inside clear	
	Height	Width
Chamber.....	6 4	8 0
Great.....	6 4	6 6
Common.....	6 4	3 0
Half.....	4 6	3 0
Branch.....	2 10	3 0
Small branch.....	2 4	2 0

TABLE XXXVI.—*Material list, gallery and shaft cases*

Item	Great	Common	Half	Branch	Small branch
Cap.....	1-4 by 10 by 7 feet 2 inches.	1-3 by 10 by 3 feet 6 inches.	1-3 by 10 by 3 feet 6 inches.	1-3 by 10 by 3 feet 6 inches.	1-2 by 10 by 2 feet 4 inches.
Sill.....	1-3 by 10 by 7 feet 2 inches.	1-3 by 10 by 3 feet 6 inches.	1-3 by 10 by 3 feet 6 inches.	1-3 by 10 by 3 feet 6 inches.	1-2 by 10 by 2 feet 4 inches.
Post.....	2-4 by 10 by 6 feet 6 inches.	2-3 by 10 by 6 feet 6 inches.	2-3 by 10 by 4 feet 8 inches.	2-3 by 10 by 3 feet 0 inches.	2-2 by 10 by 2 feet 6 inches.
Spreader.....	2-1 by 10 by 6 feet 6 inches.	2-1 by 10 by 3 feet 0 inches.	2-1 by 10 by 3 feet 0 inches.	2-1 by 10 by 3 feet 0 inches.	2-1 by 10 by 2 feet 0 inches.
Nails <sup>1</sup> pounds.....	¼ tenpenny.	¼ tenpenny.	¼ tenpenny.	¼ tenpenny.	¼ tenpenny.
Weight pounds.....	385.....	220.....	180.....	150.....	75.....

<sup>1</sup> Nails for spreaders only.

TABLE XXXVII.—Material list, gallery and shaft frames

Item	Chamber gallery	Chamber gallery	Great gallery	Common gallery
Cap, I-beam †	1-3 by 5 by 9 feet 0 inches.			
Beam shoe	2 standard			
Cap		2-3 by 10 by 9 feet 0 inches.	1-6 by 9 by 7 feet 6 inches.	1-6 by 8 by 4 feet 0 inches.
Sill		1-4 by 6 by 9 feet 0 inches.	1-4 by 6 by 7 feet 6 inches.	1-3 by 6 by 4 feet 0 inches.
Post	2-6 by 6 by 6 feet 6 inches.	2-6 by 6 by 6 feet 6 inches.	2-6 by 6 by 6 feet 6 inches.	2-6 by 6 by 6 feet 6 inches.
Spreader		2-1 by 6 by 8 feet 0 inches.	2-1 by 6 by 6 feet 6 inches.	2-1 by 6 by 3 feet 0 inches.
Nails † pounds		0.4 lb. 10d.	0.4 lb. 10d.	0.2 lb. 10d.
Weight do	250	440	375	255.

Item	Half gallery	Branch gallery	Small branch gallery
Cap	1-6 by 6 by 4 feet 0 inches.	1-4 by 5 by 3 feet 8 inches.	1-3 by 4 by 2 feet 6 inches.
Sill	1-3 by 6 by 4 feet 0 inches.	1-3 by 4 by 3 feet 8 inches.	1-3 by 3 by 2 feet 6 inches.
Post	2-6 by 6 by 4 feet 8 inches.	2-4 by 4 by 3 feet 0 inches.	2-3 by 3 by 2 feet 6 inches.
Spreader	2-1 by 6 by 3 feet 0 inches.	2-1 by 4 by 3 feet 0 inches.	2-1 by 3 by 2 feet 0 inches.
Nails † pounds	0.2 lb. 10d.	0.2 lb. 10d.	0.2 lb. 10d.
Weight do	195	80	35.

† Nails for spreaders only.

(4) *Standard sheeting.*—Sheeting is used for supporting the ground between frames in chambers and galleries and in inclines and shafts where frames rather than cases are used. Two-inch sheeting is furnished for the roof and 1½-inch for the sides. It is normally made in 5-foot lengths designed for use where frame spacing is not over 4 feet center to center, varying from 4 to 10 inches in width. For frame spacing of 3 feet center to center, 4-foot lengths of sheeting afford economy of material and work. Boards selected from the side sheeting should be used for head boards and stair risers which

are  $1\frac{1}{2}$  by 10 inches by 3 feet 6 inches in stepped inclines. If standard sheeting is not available and ground conditions are favorable, round poles  $2\frac{1}{2}$  inches in diameter at the butt and 4 to 5 feet long may be used instead.

(5) *Wedges*.—Wedges are used for bracing timbers tightly against the walls and roofs of excavation, holding them in place until settling of the ground has rendered displacement impossible. Wedges must be provided in large quantities and used freely. Dimensions of the wedge are shown in figure 136.

(6) *Bunk posts*.—Bunk posts are 4 by 4 inches and 2 by 4 inches, and are used for supporting the double tier of bunks in shelters. The 4 by 4's should be placed under the caps of the frames, thus providing additional support. In case standard materials are not available, round timber 4 inches in diameter at the small end may be substituted.

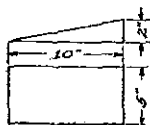

Wedge

FIGURE 136.—Standard wedge.

(7) *Use of lumber*.—Commercial lumber cut to proper lengths is used for props, bunks, gas curtain frames, battens for holding timbers in place during construction, and for strapping incline and shaft sets together, making bomb recesses, baffle boards, etc. Scrap lumber obtained during cutting should be used in conjunction with wedges for blocking timbers in place.

*b. Construction methods*.—(1) *Excavation*.—In earth the pick and shovel are used to make the excavation with the aid of such accessory tools as crowbars and pick mattocks. In advancing an incline or gallery, care should be taken not to open up more ground than is necessary to accommodate the timbering. Methods of rock excavation are not discussed here for the reason that shelter construction in rock is unusual.

(2) *Removal of excavated material*.—(a) In small headings the excavated material or "spoil" is removed from the work-

ing faces by shoveling it into bags which are carried away to the place of disposal. In fairly large headings, wheelbarrows and small tramcars may be used to convey the material away. For large jobs an electric railway installation may be desirable. In cases where disposition must be made at a considerable distance it is generally advisable to install light tracks and to operate small cars. However, to avoid noise when close to the enemy, cars should have roller bearings and wheels cushioned with rubber or other sound-killing material. Removal through shafts is ordinarily done by means of buckets and hand-operated windlasses or small power hoists.

(b) On all work in mines or shelters close to the enemy,

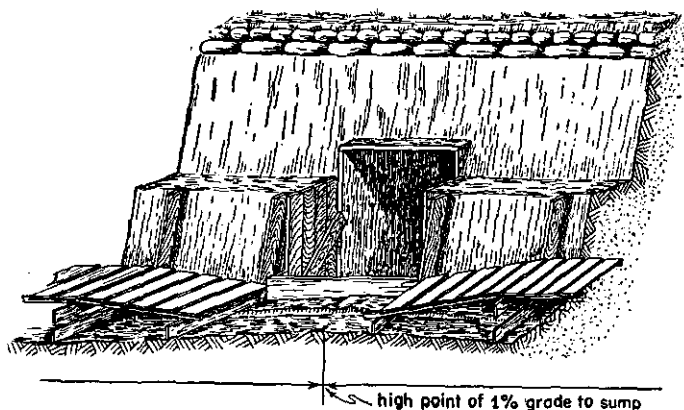
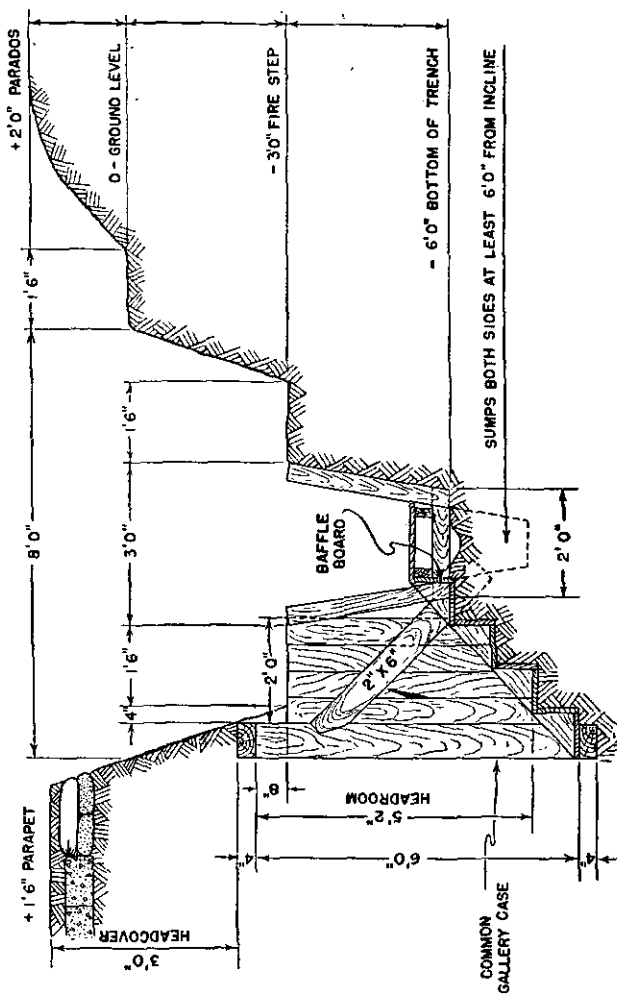

FIGURE 137.—Approach to entrance.

it is necessary to use what are called "daylight dumps"; that is, dumps which can be used in the daytime and yet not be observed by the enemy. These dumps are simply temporary storage places for the sandbags packed with spoil. At night men get out on top of the trenches and either dump the sandbags or spill the material from them into shell holes, old mine craters, abandoned trenches, sunken roads, behind hedges, or in any place concealed from the enemy. It is bad practice to build mounds of spoil. All material must be carefully camouflaged from airplane observation. When the spoil is of a contrasting color, it is



②  
FIGURE 137.—Approach to entrance.—Continued.

usually necessary to camouflage it carefully with dirt that matches the surrounding ground or other suitable material. The engineer officer in charge must carefully supervise all this work and see that the working parties do not leave spoil which should be screened from observation. A careful investigation of an area usually discloses some convenient sunken road, trench, or hedge which can be used to advantage in disposing of spoil.

(3) *Entrances.*—(a) *Approach.*—The term “approach to entrance” is given to that portion of the ground in front of the entrance to underground works which must be excavated in order to provide the necessary headroom without sacrificing overhead cover. The approach is usually necessary whether entrance is gained from a trench or a reverse slope. To simplify construction one standard type of approach to entrance has been adopted (see fig. 137). It is a direct descent from a standard trench by steps leading downward in the direction of the entrance. If desired, the sides of the approach may be flared. It is designed for use in a standard fire trench but with slight modification may be used in any form of special trench without fire step.

TABLE XXXVIII.—*Material list, approach to entrance of cave shelter (fig. 137)*

Item	Size	Unit	Quantity	Weight (pounds)
Gallery case <sup>1</sup> .....	Common.....	Each.....	1	220
Diagonal braces, to cut.....	2 by 6 inches by 8 feet.....	do.....	1	32
Baffle board.....	2 by 12 by 3 feet 6 inches.....	do.....	1	28
Revetting boards, to cut.....	1 by 6 by 10 feet.....	do.....	4	80
Stair stringers, to cut.....	2 by 10 by 10 feet.....	do.....	1	66
Stair treads, to cut.....	2 by 10 by 6 feet.....	do.....	2	30
Stair risers.....	1 by 10 by 3 feet.....	do.....	3	30
Concrete bursters.....	Standard.....	do.....	42	6,090
Sandbags.....	do.....	do.....	30	15
Nails.....	Twentypenny.....	Pound.....	3	3
Wire, bursters.....	No. 12.....	Linear feet.....	40	2
Total weight.....				6,646

<sup>1</sup> Cut posts to 6 feet 2 inches long.

(b) *Approaches from reverse slope.*—Except in cases where entry is made in a nearly vertical bluff or the face of a quarry, an approach is necessary to reach the first timbered section of an entrance on a reverse slope. It usually consists of a narrow trench driven forward on a slight upgrade to facilitate drainage until sufficient headcover is secured. It will probably need revetment near the entrance, and being a conspicuous feature on an airplane photograph must be carefully camouflaged both during construction and after completion.

(c) *Inclined.*—In order to standardize construction, one type of incline has been adopted, using standard gallery cases

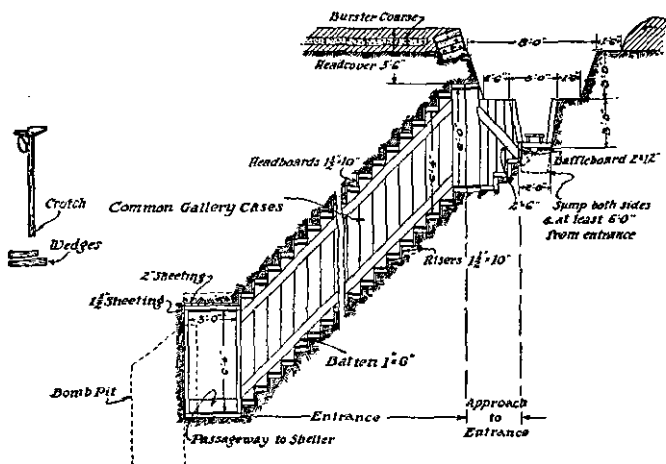

FIGURE 138.—Inclined entrance.

placed vertically. This type of entrance, also known as the stepped incline, has been selected on account of the ease with which the timbers may be set by unskilled labor. The normal size of case is the common gallery type, but in construction of first-aid shelters a larger size should be used.

(d) *Driving an incline with cases.*—In driving an incline with cases (fig. 138) the dimensions of a common gallery case are first marked at the entrance. Standard common gallery cases are used except at the top where the posts are



sawed to a length of 6 feet 2 inches instead of 6 feet 6 inches. This gives headroom of 5 feet 2 inches.

The excavation is carried horizontally for the length of two cases when the stepped incline is commenced. Excavation for the sill of each succeeding case is lowered 10 inches, providing for the steps. Cases are put in position as described above, except that headboards and risers are nailed in position to prevent the earth from caving in between successive caps and sills.

Attempt should never be made to excavate ahead for several cases to be timbered later. This endangers the lives of those working, and if the face or sides begin to "run" involves an immense amount of labor and leaves a weak entrance.

In very loose and caving soil the cap must be put in position first and supported while the grooves for the ground sill and posts are excavated, for which purpose two "crutches" (fig. 138) are used. A crutch consists of an upright piece of timber carrying a crosspiece the length of which is equal to the width of two cases. The upright piece rests upon the ground sill of a case already placed and is raised to proper height by wedges. The part of the crosspiece which projects in advance is made 2 inches higher than the rear part to support the cap somewhat above its final level, and allow the posts to be easily inserted. The rear part of the crosspiece is attached to the upright by an iron rod or short chain. When the case is set and adjusted to position, the crutches are taken down by removing the wedges and are replaced under the next cap.

Each case should be temporarily tied back to the previous one immediately upon being put in, at top and bottom, by means of a short length of sheeting to be later replaced by 1- by 6-inch battens.

The estimate of cases required for a 45° incline for any depth equals the vertical depth in inches between landings divided by 10, plus 1. The estimate of cases for a 31° incline suitable for a first-aid shelter entrance equals twice the difference in feet in elevation between landings. This slope provides for a stairway of 6-inch risers and 10-inch treads.

(e) *Sinking a shaft with cases.*—Shafts are usually sunk with cases (see fig. 134). A shaft case of the required size

is put together and accurately placed on the site of the shaft, the dimensions of which are marked on the ground outside it. The case is then removed and the earth excavated to the depth of the case which is placed in the excavation with its top flush with the surface of the ground. Its position is carefully verified and it is secured in position by packing earth around it. The excavation is then continued for the depth of another case which is put in place as follows:

One end piece is placed in position, the two sides are engaged with the end and pushed back into position; a pocket-shaped excavation is made beyond the end of one of the side pieces and running back 3 or 4 inches into the side wall; the remaining end piece is inserted in this cavity far enough to allow its opposite end to slip over the side and fall into place by drawing against the side pieces. The case may be toenailed and fastened to the higher one by short battens.

The next case is placed in the same way, care being taken not to excavate two consecutive pockets in the same corner. It is well to fill up these pockets by stuffing in from below before placing the next case.

Upon reaching the level of the top of the gallery the pieces on the gallery side of the shaft are omitted if the ground is firm, but if it needs support these pieces are put in place and secured by cleats or braces.

(f) *Sinking a shaft with frames and sheeting.*—In sinking a shaft with frames and sheeting (fig. 139), the size and position having been fixed, the top frame is laid down and staked in place, with scores on the end pieces accurately in the desired position. The excavation of the shaft is then begun, making it enough larger than the top frame to take the sheeting all around. Usually the first interval can be dug without driving the sheeting. It is undercut so that at the level of the second frame it will be larger in each direction than at the top by twice the thickness of the sheeting. Gage rods cut to the length and width of the excavation and plainly marked at the middle points should be provided. The inconvenience of working under the top frame may be avoided by marking the sides carefully and digging the first interval before setting the top frame.

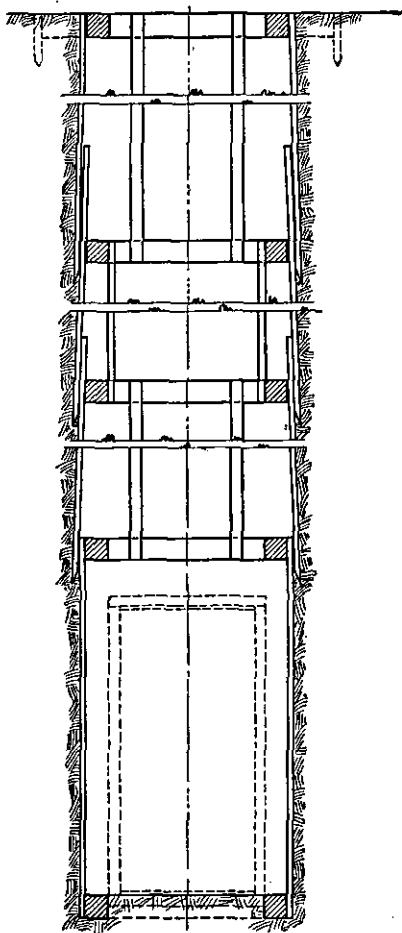

FIGURE 139.—Shaft with frames and sheeting.

When the shaft is deep enough the second frame is put in place and *nailed* together. The top and second frame are connected by nailing to them four battens of proper length (two on each side) (fig. 139), which suspend the second from the top frame at the established interval. The second frame is placed vertically below the top frame by using a plumb line.

The sheeting is inserted outside the top frame, beveled end first, bevel inside, and pushed down until its top is flush with the top frame. The lower end of the sheeting is held out from the lower frame by suitable wedges to permit insertion of the second interval sheeting, and excavation of the second interval is commenced.

In ordinary soil the sides of the shaft require support. Sheeting is therefore introduced and pushed down as the excavation proceeds, the wedges previously placed being driven down as the sheeting is inserted.

If the pressure of the earth becomes great enough to spring the sheeting planks inward, an auxiliary frame is added. This is a frame similar to the shaft frames but from 4 to 6 inches larger in outside dimensions. The sheeting rests directly against the outside of this frame, and is thus held out far enough to allow the third frame to be placed and wedges to be inserted as before. The auxiliary frame is then removed and used in the next interval.

Successive frames are placed in the same manner (fig. 139) until the one directly over the gallery is reached. Care is taken to place this frame at exactly the right height, and the shaft is then continued to the required depth. A frame is placed at the bottom with its top at the level of the floor of the gallery and the sheeting is allowed to rest directly against the outside of this frame. When the soil permits it, the sheeting is omitted wholly or in part over the portion of the shaft which is to form the gallery entrance.

*Precautions.*—In sinking shafts, special care must be taken to make the excavation no larger than is required for placing the lining since if a vacant space is left outside the lining, the sides of the shaft may give through its entire height and fall against the lining with a blow, crushing it in. This has often been the cause of fatal accidents in both shafts and galleries.

(4) *Driving a gallery with cases.*—Driving a gallery with cases is the same operation as described for driving an incline with cases ((3) (d) above) except that the excavation is not stepped and headboards and risers are omitted.

(5) *Driving a gallery or chamber with frames and sheeting.*—(a) If driven from the bottom of an incline, the direction of the gallery is marked by scores on the incline cases.

(b) Two gage rods are prepared, giving the extreme height and breadth of the excavation, that is, height of the frame plus two thicknesses of top sheeting, and breadth of the frame plus four thicknesses of side sheeting. The middle of each gage rod is also marked plainly. A gallery frame is set up, carefully located, and fastened in position with battens and braces. The top gallery sheeting is started on top

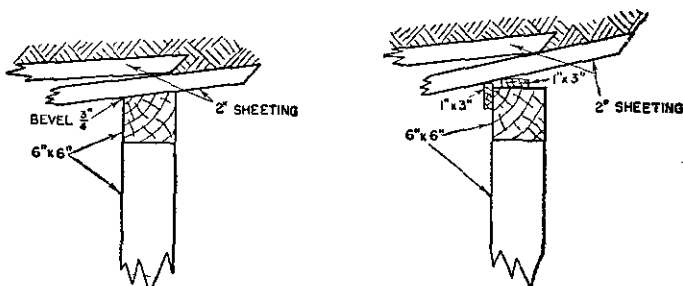

FIGURE 140.—Detail of gallery construction.

of the cap and driven until held in place by the earth. It is given the proper upward pitch by beveling the cap or by scantling laid across the ends of the sheeting and held down by fastening to the gallery frame (see fig. 140). This upward pitch is necessary to make room for placing the next frame and sheeting. The side sheeting is started in the same way against the outer faces of the posts and given an outward slant by bracing the outer ends slightly away from the sides of the gallery or by use of scantling. Earth is excavated and the sheeting advanced, keeping the front ends in solid earth to hold them steady and to give semiprotection to the workmen.

(c) In this way the gallery is advanced one gallery interval, usually about 3 or 4 feet, when a second frame is placed. Its position is verified by the score marks; for direction by a line; for grade by a spirit, mason's, or field level, and for verticality by a plumb line. It is then secured in place by nailing battens to it and the preceding frame. Wedges are inserted between the second frame and the sheeting to allow room for insertion of the sheeting for the next interval and the gallery is continued by the same methods (fig. 140). When the sheeting is advanced only by hard driving, the frames are slightly inclined to the rear at first and are afterwards driven forward until vertical.

(d) If while advancing the sheeting pressure upon it becomes so great as to spring it, a false frame must be used (fig. 140.) This consists of a cap, a sill, and two posts connected by mortises and tenons. The posts have tenons, and the cap and sill mortises at each end. The cap may be rounded on top and, for facility in setting up and removing, its mortises are longer than the width of the tenons. The latter are held in place by key wedges when the frame is in position. The false frame is usually made the same height as the common frames and wider by twice the thickness of the sheeting.

(e) In using this frame, the sill is first placed accurately in position at a half interval in advance, the posts are set up, and the cap placed upon them and wedged. The whole frame is then raised about 2 inches by driving wedges under the sill, and is secured by battens. The sheeting now rests directly upon the cap and posts and has enough inclination to clear the next frame by its own thickness, as is required. The next frame is then set up, the wedges driven under the sheeting, and the false frame removed, which is easily done owing to its construction.

(f) In loose, caving ground, when pressure on the sheeting is too great for driving, bridges are used (fig. 140) which consist of 3-inch blocks of width and length equal to the cap or post. A frame being in position, a bridge is placed over the cap supported at each end by wedges the thickness of the sheeting. The bridge is used to keep the rear sheeting from bearing hard on the cap, thereby allowing an opening

through which the forward sheeting is driven. As the sheeting is driven forward piece by piece, it is sometimes necessary to pick the material away from the point of each board. In this manner the entire shield of sheeting is advanced until in its final position. The next set is blocked into position and the same process continued. When necessary to hold up the sheeting during the final operation of placing the

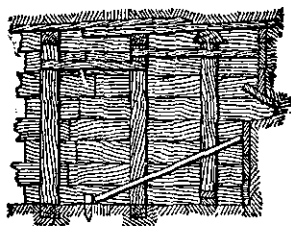

FIGURE 141.—Use of shield.

next set, a false set as described, or posts and headboard may be put in place to be removed when the next permanent set is placed. Side sheeting is driven as for roof sheeting under similar ground conditions.

(g) To drive the gallery in very loose soil, a *shield* (fig. 141) may be used to prevent the earth in front and above from

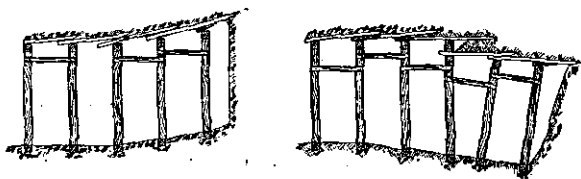

FIGURE 142.—Change of slope.

caving into the gallery. When excavation at top of gallery has advanced as far as it can go without causing the caving to extend beyond the top sheeting, a piece of plank a foot wide and in length equal to the width of the gallery is placed directly under the top sheeting and against the face of the excavation and is held in place by braces at its ends secured to the gallery lining. The earth is excavated until a second

plank of the shield can be placed in the same way as before under the first one. This is continued until the entire face is covered. The top and side sheeting are then driven forward and the top plank of the shield is removed and replaced in advance, after which each plank is removed and replaced in succession as previously described.

(h) *Change of slope* (fig. 142).—To pass from a horizontal to an ascending gallery, it is only necessary to give the top sheeting the proper angle by holding down its back end with a piece of scantling placed across the gallery for that purpose, and to give the side sheeting the proper inclination, cutting trenches in the bottom of the gallery for the lower pieces if necessary.

In passing from a horizontal to a descending gallery the roof may be carried forward horizontally and the floor given the desired pitch by increasing the height of the consecutive frames until enough headroom is obtained to allow the top sheeting for the descending gallery to be inserted at the proper height and in the new direction. The frame at this point is made with a cap (upon which the sheeting rests directly), and a second crosspiece below it, serving as a cap for the descending gallery. From this point forward the frames may be set perpendicular to the axis of the gallery.

If the descending gallery is very steep and the horizontal pressure of the soil great, it may be necessary to strengthen the posts of the last two or three vertical frames by crosspieces near their upper ends.

(i) *Changing direction horizontally*.—In changing direction horizontally with frames and sheeting, if the soil will stand for a distance of one frame interval or even less, it is only necessary to place one or more frames at an angle until the necessary change is secured. The sheeting on the outside is placed by running the forward end past the frame and then inserting the rear end behind the last bay of sheeting.

If the sides require constant support (fig. 143) the outer one may be continued in the old direction until the wedge left is thick enough to permit the sheeting to be driven in the new direction. A short bay may be put in to reduce the amount of work to be done. Frames with extra long caps and



sills are required, and the last one used is given an extra post on the outside to take the sheeting in the new direction.

For abrupt changes of direction in large galleries it is customary to drive in the original direction entirely past the turning point and then break out a gallery in the new direction. A gallery starting out from the side of another is called

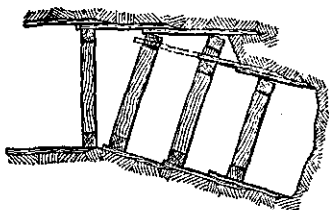

FIGURE 143.—Change of direction requiring constant support.

a *return* and is rectangular or oblique according to the angle made by its axis with that of the original gallery, which is called the gallery of departure (see fig. 144).

That the return may be broken out, the interval between the frames of the gallery of departure at this point must be such as to admit between the posts a frame and the side

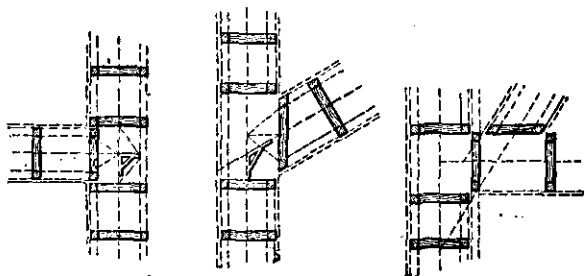

FIGURE 144.—Breaking out returns.

sheeting of the return. This part of the gallery of departure is called a *landing*, and its floor is made horizontal.

If the return is oblique, its width measured along the gallery of departure is determined by an oblique section, and may be so great that the strength of the lining of the gallery of departure does not allow necessary length of landing. In

this case a short rectangular return is first broken out from the side of the gallery of departure and the new gallery is broken out from the side of this return. The latter method diminishes length of the landing when change of direction is less than  $45^{\circ}$ .

The floor of a return is started at the level of the floor of its landing. In firm soil which will stand for a short time without support, the first frame may be set up entirely outside the gallery of departure and may be of the same height in clear as this gallery. When the soil is bad, however, and side sheeting is required in the gallery of departure, the first frame of the return must be set up against this sheeting in the interval between posts of the landing. This makes the clear height of the return at this frame less than that of the gallery of departure by a little more than the thickness of the sheeting. When the first frame of the return is set against the sheeting of the gallery of departure, the sheeting may be pulled or cut away to permit excavation, beginning in either case with the top plank.

The first frame of an oblique return should be so set that the sides of the posts are parallel to the side walls of the return, thus giving a good bearing to the side sheeting.

In very bad soil the first few frames of a return must be firmly braced by battens connecting them together and by struts across the gallery of departure to resist the backward thrust of the earth. The latter are removed when the return is sufficiently advanced.

(6) *Chambers.*—(a) In carrying a wide face of ground as in chamber excavations, care must be taken to prevent falls of earth from the roof, and excavation of the whole face in one piece should not be attempted.

(b) Earth should be excavated on sides and top, leaving a supporting bench in the center which should not be excavated until the frame is put in place.

(c) Chambers should not be at intervals of less than 20 feet.

(7) *Emergency exit.*—(a) An emergency exit should be added as soon after completion of the shelter as possible. It may consist of an incline or a vertical shaft equipped with a ladder.

(b) It should emerge at some point such as a shell hole where it is secure from observation and detection by enemy troops actually on the ground. Its purpose is to prevent trapping troops in the shelter and to permit launching a counterattack by the occupants.

(8) *Lines and grades.*—(a) *Line.*—A string stretched along shallow saw cuts in centers of caps and sills is the simplest method of maintaining straight lines in timber construction. Plumb bobs hung from nails in center of caps are used for lining by eye. Sills should be leveled and posts plumbed while the frame or case is being lined and blocked into place.

(b) *Grades.*—The minimum grade which will insure drainage in galleries and chambers is about 1 foot per 100 feet (1 percent). Uniform grades are difficult to maintain without a level and a grade board. A convenient size of grade board is made from a straightedge piece of 1½- by 6-inch lumber from 6 feet to 12 feet long with a small cleat nailed on one end. The cleat is of such thickness that when the board is placed on a surface with a carpenter's level on top, the desired grade will be obtained when the level bubble is centered.

*c. Plans and lay-out for cave shelters.*—(1) *Plans.*—Before starting work location sketches showing over-all dimensions are necessary in order that proper material may be ordered or prepared.

(2) *Lay-out.*—(a) *Work* is simplified if the shelter is so placed that all entrances are perpendicular to the same base line. The chamber should be perpendicular to the probable direction of fire for the reason that the probable error of artillery fire in deflection is less than the probable error in range.

(b) Lay a base line parallel to the long axis of the chamber and so mark this line that it can be re-laid easily should it be destroyed.

(c) Mark center lines of entrances on this base line, and from each side of the mark at a distance equal to one-half the outside width of the entrance, erect perpendicular lines to the points where the first frames are to be placed. The perpendiculars to the two ends of a frame must be of equal length so that the first frames will be set parallel to the base

line. It is very important that these first frames be accurately set.

(d) The horizontal distance of each frame from the base line and the difference in elevation between the various frames must be determined. This work is usually done with a carpenter's level and square, and difficulty will be experienced in checking accurately.

(e) The axis of the incline must be carried in a plane perpendicular to the base line which is usually accomplished by sighting along the sides of the incline.

d. *Types of cave shelters.*—(1) Standardization and simplification of cave shelter construction facilitate use of standard materials already described.

(2) There are two standard types of cave shelters, recess and gallery. Variations may occur in shelters for special purposes as in the case of first-aid shelters which require wider entrances and passages, and gentler slopes for handling litters.

(a) The *recess*, 8 feet inside width, employs the chamber gallery. The passage in the shelter is at the side, thus leaving the bunk space in a recess with the bunks perpendicular to the passage. This type is recommended for use where conditions do not impose another selection. It is favored by economy in space, labor, and material per occupant; there are 70 cubic feet of excavation per linear foot and per occupant, and 113 feet board measure of lumber per man are required.

(b) The *gallery*, 6 feet 6 inches inside width, employs the great gallery. In this type the connecting passage or entrance is central with the axis of the room, thus permitting two lines of bunks parallel with the long axis of the chamber, one on each side of the passage. There are 62 cubic feet of excavation per linear foot, 93 cubic feet per occupant, and 185 feet board measure of lumber per occupant are required. It is simpler to construct than the recess shelter, but this advantage is usually outweighed by the economy of the recess type in excavation and materials.

(3) In construction of shelters, the room or chamber proper, the connecting passages, the entrances which may be by incline or not as conditions require, and the approach to entrances are to be considered. Lay-outs for several

requirements as to use of cave shelters are given in figures 145 to 151.

(4) In addition to the classification of types given above, shelters may fall in any of the following classes:

(a) Infantry cave shelters (personnel) (figs. 145, 146, 147).

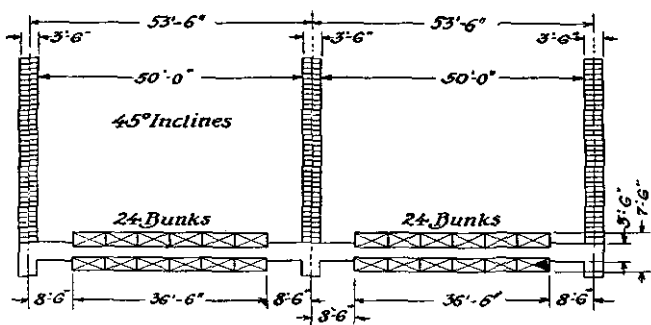

Gallery Type

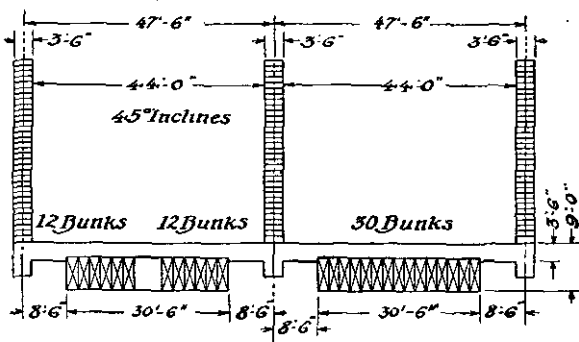

Recess Type

FIGURE 145.—Standard infantry cave shelters.

- (b) Command posts (fig. 148).  
 (c) Artillery cave shelters (figs. 149 and 150).  
 (d) First-aid shelters (fig. 151).

(5) In connection with the approach or connecting galleries between chambers, the details of gallery construction with frames and sheeting with standard material have been shown in figures 140, 141, 142, 143, and 144.

*e. Infantry cave shelters.*—(1) *Standard arrangements* of infantry cave shelters of the recess and gallery types with connecting passages, inclines, and entrances are shown in figure 145.

(2) An example of a lay-out for infantry cave shelters of the recess type is shown by figure 146 with a material list

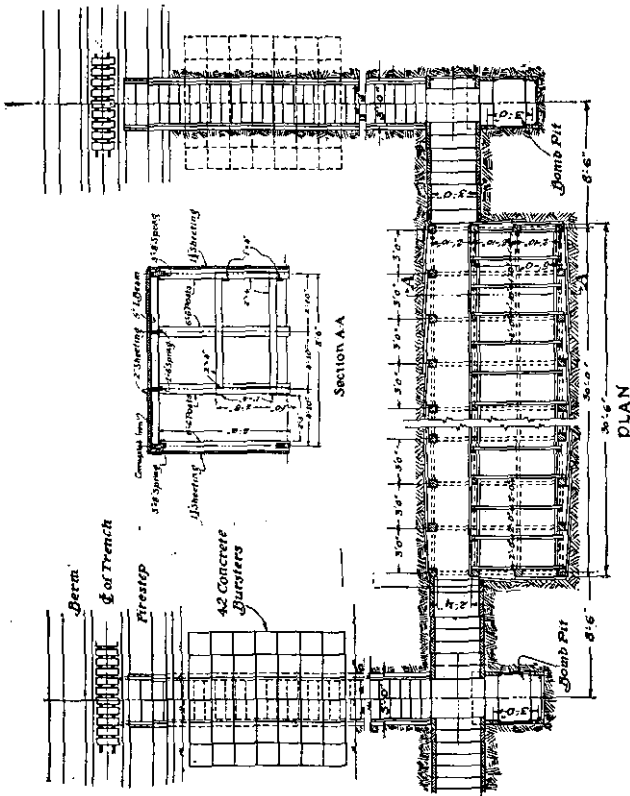

FIGURE 146.—Infantry cave shelter (recess type).

in table XXXIX. Capacity of the shelter is 30 men in double-tier bunks. Inclines having a depth of 25 feet between landings and approaches, passages, and bomb pits are covered in material list. It is desirable to extend the weight columns in the requisition to assist the engineer supply officer in providing for transportation.

TABLE XXXIX.—Material list, infantry cave shelter, recess type (fig. 146)

CHAMBER

Item	Size	Unit	Quantity <sup>1</sup>	Weight (pounds)
Frame, I-beam	Chamber	Each	11 (2)	2,750
Posts, end frames only	6 by 6 by 6 feet 6 inches	do	4	310
Post, bunk	4 by 4 by 6 feet 6 inches	do	4 (1)	140
Sprag, top and bottom, slides.	3 by 8 by 6 feet	do	20 (4)	960
Sheeting, top, 4 inches to 10 inches wide.	2 by 6 by 5 feet	do	180 (36)	3,600
Sprag, top, center	2 by 6 by 6 feet	do	10 (2)	240
Bunk frame, lengthwise.	2 by 4 by 6 feet	do	32 (6)	515
Bunk frame, crosswise.	1 by 4 by 6 feet	do	10 (2)	80
Post, bunk	2 by 4 by 3 feet 8 inches.	do	20 (4)	195
Sheeting, side, 4 to 10 inches wide.	½ by 6 by 5 feet	do	280 (56)	4,200
Sheeting, ends only	1½ by 6 by 5 feet	do	56	840
Battens	1 by 6 by 12 feet	do	5 (1)	120
Bunk frame	1 by 4 by 7 feet	do	10 (2)	95
Wedges	Standard	do	110 (20)	155
Flooring, if used	1-inch	Square feet	100 (20)	400
Corrugated iron, galvanized.	9 feet by 24 inches, No. 20.	Sheets	20 (4)	640
Wire netting, bunks	72 inchs wide, 2-inch mesh.	Linear feet	65 (13)	30
Wire, bunks (8 crosswise).	No. 12	do	750 (150)	25
Staples, bunks	¾-inch, No. 9	Pound	15 (3)	15
Nails	Tenpenny	do	1.25 (.25)	2
Do	Twentypenny	do	20 (4)	20
Total weight				15,332

<sup>1</sup> Figures in parentheses show quantities required for unit length of 6 feet.

## PASSAGES AND BOMB PITS

Gallery cases.....	Common.....	Each.....	28	6, 160
Battens.....	1 by 6 by 10 feet.....	do.....	8	160
Wedges.....	Standard.....	do.....	112	160
Sheeting, top, bomb pit.	2 by 6 by 5 feet.....	do.....	14	280
Sheeting, side, bomb pit.	1½ by 6 by 5 feet.....	do.....	48	720
Furring strips, bomb pit.	2 by 2 by 6 feet.....	do.....	12	95
Nails.....	Tenpenny.....	Pound.....	8	8
Total weight.....				7, 583

## TWO INCLINES (25 FEET BETWEEN LANDINGS)

Cases, gallery.....	Common.....	Each.....	62	13, 640
Battens.....	1 by 6 by 10 feet.....	do.....	28	560
Wedges.....	Standard.....	do.....	248	345
Headers and risers.....	1½ by 10 by 3 feet 6 inches.	do.....	122	2, 135
Nails.....	Tenpenny.....	Pound.....	10	10
Total weight.....				16, 690

## TWO APPROACHES

Cases, gallery.....	Common.....	Each.....	2	440
Diagonal braces, to cut.	2 by 6 by 8 feet.....	do.....	2	65
Baffle boards.....	2 by 12 by 3 feet 6 inches.	do.....	2	55
Revetting boards.....	1 by 6 by 10 feet.....	do.....	8	160
Stair stringers.....	2 by 10 by 10 feet.....	do.....	2	130
Stair treads.....	2 by 10 by 6 feet.....	do.....	4	160
Stair risers.....	1 by 10 by 3 feet.....	do.....	6	60
Wedges.....	Standard.....	do.....	8	10
Concrete bursters.....	do.....	do.....	84	12, 180
Sandbags.....	do.....	do.....	60	30
Nails.....	Twentypenny.....	Pound.....	10	10
Wire, bursters.....	No. 12.....	Linear feet.....	80	4
Total weight.....				13, 304



## MATERIAL LIST CONSOLIDATED

Item	Unit	Quantity <sup>1</sup>	Weight (pounds)
Gallery frames, I-beams, chamber size	Each	11 (2)	2,750
Gallery cases, common size	do	92	20,240
6 by 6 by 6 feet 6 inches	do	4	310
4 by 4 by 6 feet 6 inches	do	4 (1)	140
3 by 8 by 6 feet	do	20 (4)	960
2 by 12 by 3 feet 6 inches	do	2	55
2 by 10 by 10 feet	do	2	130
2 by 10 by 6 feet	do	4	160
2 by 6 by 8 feet	do	2	65
2 by 6 by 6 feet	do	10 (2)	240
2 by 6 by 5 feet (or equivalent 4 to 10 inches wide).	do	104 (36)	3,880
2 by 4 by 6 feet	do	32 (6)	515
2 by 4 by 3 feet 8 inches	do	20 (4)	195
2 by 2 by 6 feet	do	12	95
1½ by 10 by 3 feet 6 inches	do	122	2,135
1½ by 6 by 5 feet (or equivalent 4 to 10 inches wide).	do	384 (56)	5,760
1 by 10 by 3 feet	do	6	60
1 by 6 by 12 feet	do	5 (1)	120
1 by 6 by 10 feet	do	44	880
1 by 4 by 7 feet	do	10 (2)	95
1 by 4 by 6 feet	do	10 (2)	80
Wedges, standard	do	478 (20)	670
1-inch flooring	Square feet	100 (20)	400
Corrugated iron, galvanized, 9 feet by 24 inches, No. 20.	Sheets	20 (4)	640
Wire netting, bunks, 72 inches wide, 2-inch mesh.	Linear feet	65 (13)	30
Wire, bunks, No. 12	do	750 (150)	25
Wire, binding, No. 12	do	80	4
Staples, ¾-inch, No. 9	Pound	15 (3)	15
Nails, tenpenny	do	20 (.25)	20
Nails, twentypenny	do	30 (4)	30
Concrete bursters, standard	Each	84	12,180
Sandbags, standard	do	60	30
<b>Total weight</b>			<b>52,909</b>

<sup>1</sup> Figures in parentheses show quantities required for unit length of 6 feet.

WEIGHTS

Item	Pounds	Tons
I-beams and shoes (chamber frames).....	1,025	0.51
Lumber.....	38,910	19.45
Concrete bursters.....	12,180	6.09
Miscellaneous.....	794	.40
<b>Total weight.....</b>	<b>52,909</b>	<b>26.45</b>

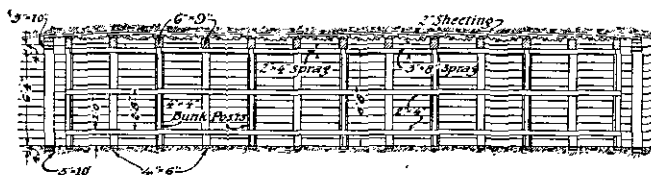
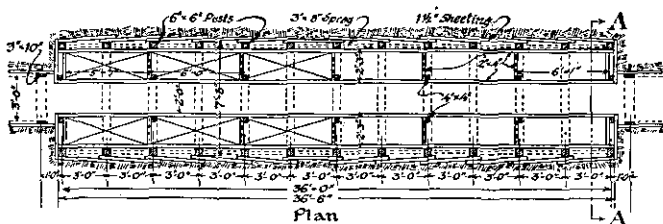
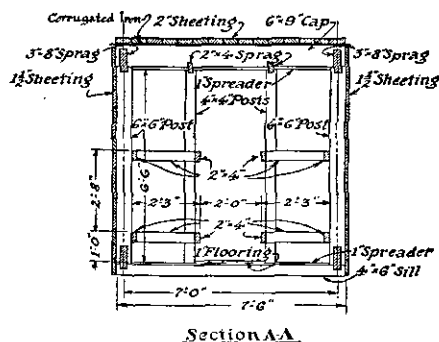

FIGURE 147.—Infantry cave shelter (gallery type), longitudinal section.

(3) An example of a gallery type infantry cave shelter with material list in table XL is shown in figure 147. Materials for inclines, approaches, passages, and bomb pits are not included. Capacity of the shelter is 24 men in double-tier bunks. Estimates for any arrangement of connecting passages and entrances may be made by using proper combinations.

TABLE XL.—Material list, infantry cave shelter, gallery type (fig. 147)

Item	Size	Unit	Quantity <sup>1</sup>	Weight (pounds)
Frames, gallery	Great	Each	13 (2)	4,875
Post, bunk	4 by 4 by 6 feet 6 inches	do	14 (2)	485
Sprag, top and bottom, sides.	3 by 8 by 6 feet	do	24 (4)	1,150
Sheeting, top, 4 to 10 inches wide.	2 by 6 by 5 feet	do	180(30)	3,600
Bunk frame, crosswise, to cut.	2 by 4 by 8 feet	do	7 (1)	150
Bunk frame, lengthwise.	2 by 4 by 7 feet	do	48 (8)	895
Sprag, top center	2 by 4 by 6 feet	do	48 (8)	895
Do.	do	do	12 (2)	190
Sheeting, side, 4 to 10 inches wide.	1½ by 6 by 5 feet	do	360(60)	5,400
Sheeting, ends only, 4 to 10 inches wide.	do	do	30	450
Wedges	Standard	do	130(20)	180
Flooring	1-inch	Square feet	90(15)	360
Corrugated iron, galvanized.	8 feet by 24 inches, No. 20.	Sheet	24 (4)	696
Wire netting	36 inches wide, 2-inch mesh.	Linear feet	156(26)	40
Wire, bunk	No. 12	do	450(80)	12
Staples	¾-inch, No. 9	Pound	12 (2)	12
Nails	Fortypenny	do	12 (2)	12
Total weight				19,402

<sup>1</sup> Figures in parentheses show quantities required for unit length of 6 feet.

## WEIGHTS

Item	Pounds	Tons
Lumber.....	18,630	9.31
Miscellaneous.....	772	.39
Total.....	19,402	9.70

*f. Command posts.*—(1) Several plans of command posts are shown in figure 148. The lay-out of command posts cannot be standardized as each situation will present a different problem in providing floor space required with least expenditure of labor and material. Floor space required for command posts of various units is given in paragraph 64. For other types of command posts see paragraphs 39c and 57e. Material lists for complete work may be computed as heretofore indicated.

(2) Note that in the suggested designs of command posts in figure 148 all passages are of the common gallery size and the rooms are of the chamber gallery size and similar to figure 146. In general, command posts for the larger units will consist of a combination of rather small chambers at right angles to the passage and long recessed chambers along the passage. The small chambers will normally be used for combined offices and quarters for commissioned personnel of the staff while the long recessed chambers will contain bunks for the enlisted men. Chambers built at right angles to the passages should not extend more than 15 feet unless ventilation holes or shafts are constructed in the end of the room.

(3) In computing floor space of shelters to be used for command posts, the area of passages should not be included since all passages must be kept open and unobstructed.

*g. Artillery.*—(1) Lay-outs for artillery cave shelters are shown in figures 149 and 150. Note that the standard chamber gallery and the common gallery sizes are used. Estimates for material for arrangements shown or for any adopted arrangement may be made as heretofore indicated.

(2) The arrangement of the four guns of a battery in line is not essential as they may be echeloned or divided into

groups. Not more than 15 men per piece should be housed at the gun, the remainder of the unit being housed in a shelter 200 or 300 yards away. It is advisable in some cases to construct the command post away from the guns. A first-aid shelter should be located 200 or 300 yards away.

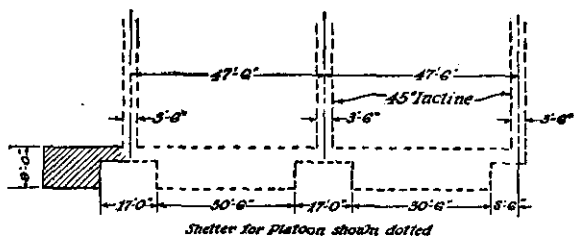

C. P. for a small unit such as an infantry platoon.

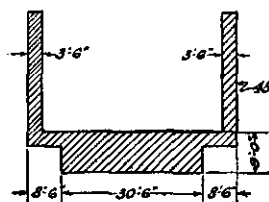

C. P. for a company

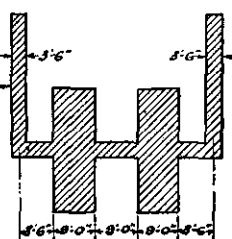

C. P. for a battalion

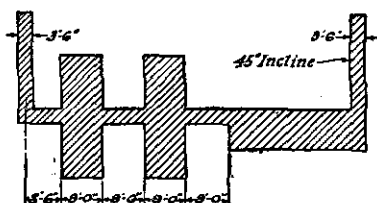

C. P. for a regiment

FIGURE 148.—Lay-out of command posts.

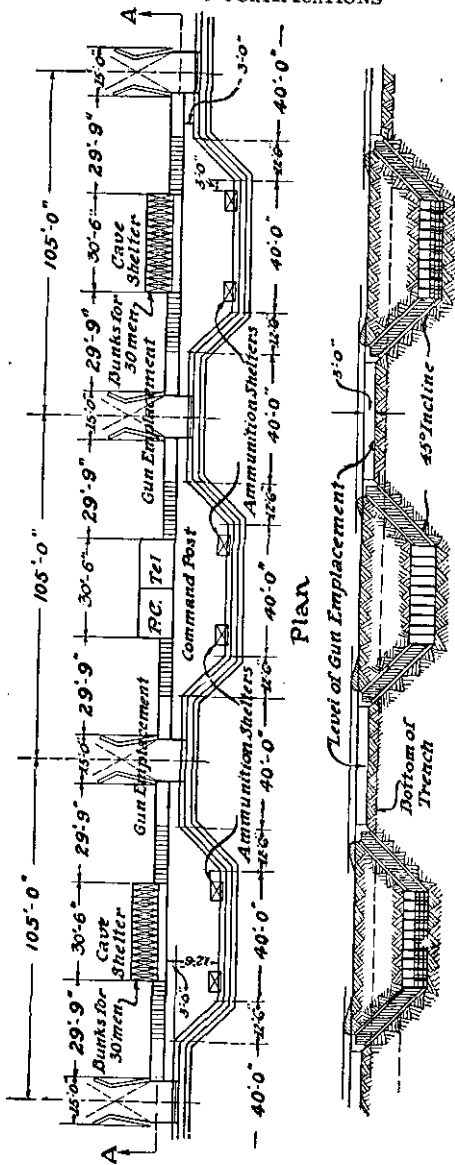

**Section A-A**

FIGURE 149.—Artillery cave shelter, octagonal.

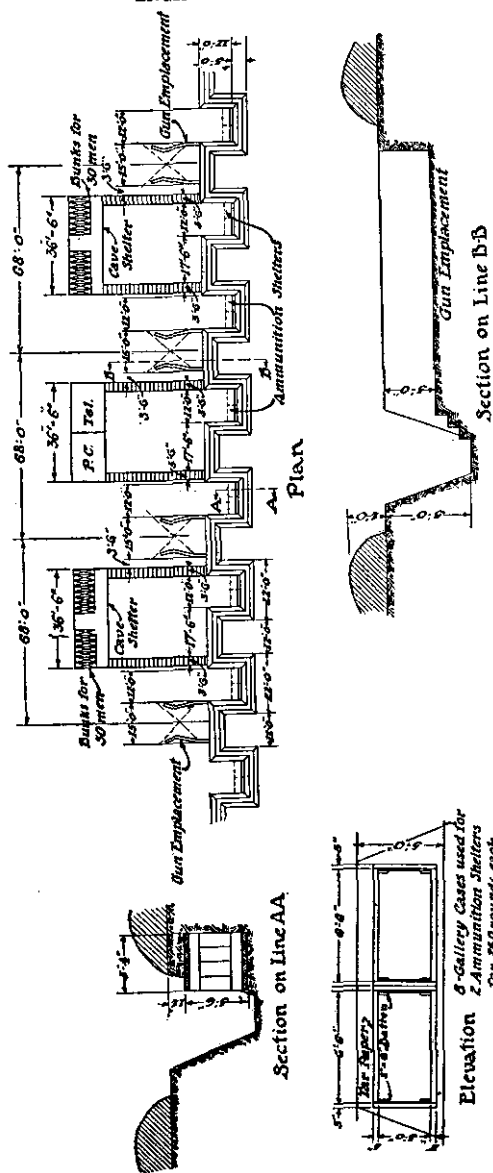

FIGURE 150.—Artillery cave shelter, traverse.

NOTE: Posts are sunk 2" below floor level except in soft ground when 2" C sleepers will be used

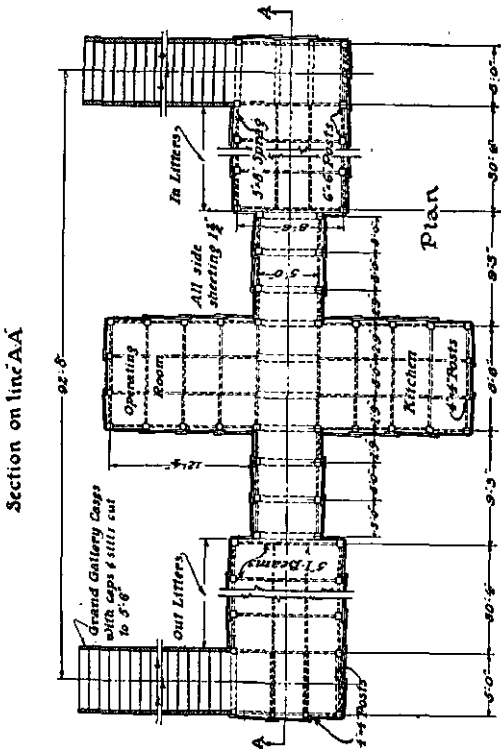
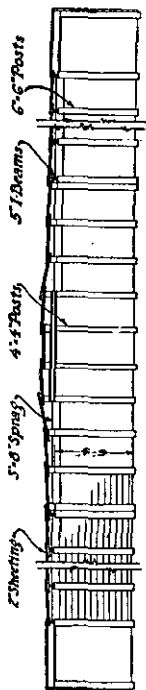
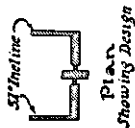

FIGURE 151.—First-aid cave shelter.



(3) Where conditions prohibit construction of cave shelter, some form of cut-and-cover shelter may be substituted. The designs shown in the figures are not intended for any particular gun or howitzer.

*h. First-aid.*—(1) Figure 151 shows a shelter adapted for first-aid use, having ease of passage for litter bearers through passages, aisles, and inclines. Note that rooms are made with standard chamber gallery frames and connecting aisles with great gallery frames with the caps and sills shortened to a length of 5 feet 6 inches. Estimate for material for this arrangement may be obtained as heretofore indicated.

(2) The  $45^\circ$  incline is too steep for handling litters with ease; an incline of about  $31^\circ$  is preferable.

*i. Protection of entrances.*—(1) Entrances should be concealed from enemy observation and protected from destructive shell fire. Usually they open to the rear (out of the front slope of a trench), occasionally to a flank, but never to the front. They should be so far apart that more than one cannot be blocked by a single shell burst, usually 50 feet and never less than 40 feet. There should be at least one angle or bend in the trench between them, and they should be at least 5 feet from such angle.

(2) There should be at least 3 feet initial headcover over the top of the first frame of the entrance proper, and a burster course from 5 to 12 inches thick composed of rock, broken stone, or concrete slabs should be placed above the entrance not more than 1 foot from the surface. No attempt should be made to strengthen the head of the incline by logs, rails, I-beams, concrete arches, extra heavy timbers, or complicated bracing. Amount of protection gained in this way would be much more apt to cause a serious block in the entrance if hit because of difficulty of clearing away broken logs, twisted rails, etc.

(3) No form of defense against grenades which would tend to obstruct the entrance to a cave shelter or delay rapid exit can be permitted. The only protection allowable is a grenade or bomb pit at the bottom of the dugout constructed by lining a shaft in prolongation of the inclined shaft to a depth of 6 feet below the gallery level (see fig. 146). This is constructed after the shelter is completed and may be used also as a

sump, but must be kept clear of debris. Grenade pits are constructed only in shelters in forward areas where raids are likely to occur.

(4) The best protection for entrances to cave shelters is concealment from ground observation and from discovery by aerial photography (see FM 5-20). To avoid ground observation, entrances should be located on reverse slopes, in old quarries, sunken roads, etc. To avoid detection by aerial photography they should be located in trenches used for other purposes. They should cause no visible break in parapet nor otherwise modify appearance of the trench. Rectangular notches in or projections from firing crests of trenches are especially conspicuous and easily distinguished on aerial photographs. Locating shelters in woods protects them from both ground and air observation.

*j. Quantities of materials required.*—(1) Material lists for any lay-out in which the standard materials are used may be made up from the list for each type of structure included in the lay-out. Thus, for a cave shelter, the tables for a certain type of chamber, an entrance passage (inclined or otherwise), and an approach to entrance will ordinarily be used (see fig. 146). If several chambers are connected underground, the table for the proper size of gallery for the connecting passage will also be used.

(2) The following allowances have been made in tables for materials:

(a) Standard wedges per set:

Framed gallery-----	10
Cased gallery-----	4

(b) Sandbags, per square foot of revetting face----- 3

(c) Burstiers, per entrance (7- by 6-inch)----- 42

(d) Miscellaneous:

Wire netting, 36-inch, 2-inch mesh, per bunk, linear feet-----	6.5
---	-----

Staples, per bunk, pound, $\frac{7}{8}$ -inch, No. 9-----	.5
---	----

*k. Rate of work.*—In calculating size of working parties and rate of work, the following figures may be taken as average.

These parties perform all work including timbering, exclusive of disposal of spoil on the surface.

(1) *Inclines*.—Common gallery, size 6 feet 4 inches by 3 feet inside clear dimensions.

1 relief—	{	1 man picking and timbering.
		1 man filling sandbags and timbering.
		1 man carrying for each 10 feet that working face is from entrance.

Average progress for each shift of 8 hours about 3 feet 6 inches; may vary from 1 to 7 feet, depending on all conditions.

(2) *Passages*.—Galleries, common gallery size.

Working party same as for inclines.

Average progress for each shift of 8 hours about 4 feet. May vary from 1 to 8 feet, depending on all conditions.

(3) *Chambers*.—(a) Chamber gallery size, 6 feet 4 inches by 8 feet inside clear dimensions.

2 men picking.

4 men filling sandbags and timbering who relieve pickmen as they tire.

Add 1 man per pickman for each 10 feet of carry.

Average progress for each shift of 8 hours about 3 feet. May vary from 1 to 6 feet, depending on all conditions.

(b) Great gallery size, 6 feet 4 inches by 6 feet 6 inches inside clear dimensions.

Working party same as (a) above.

Average progress for each shift of 8 hours about 3 feet 6 inches. May vary from 1 to 8 feet, depending on all conditions.

(4) Surface carrying party:

1 man can carry 100 sandbags a distance of 200 feet in 8 hours on surface under ordinary trench conditions.

1 bag equals 0.5 cubic foot, about 50 pounds.

(5) Labor underground can be economized by use of mining cars, windlasses, etc.

■ 59. *DRAINAGE*.—a. *Surface and rain water*.—Surface and rain water must be excluded from all shelter entrances. If drainage of the trench is sluggish, two sumps must be dug

in the bottom of the trench at least 6 feet clear of the sides of the entrance, and strongly revetted. The bottom of the trench in front of the entrance must then be graded to the sumps so that the highest point comes in front of the entrance. Where the entrance takes off directly from the trench baffle boards must be used. These should extend at least 6 inches beyond sides of the entrance, and to a height of 10 inches above the bottom of the trench. Admission of direct rainfall into entrances must be prevented either by design of entrance or by construction of some form of weatherproof shelter over it.

*b. Seepage.*—Protection against water seeping into chambers is essential, particularly in the case of cave shelters. In a cut-and-cover shelter this is accomplished by placing corrugated iron in the roof above the sheeting (see fig. 130). In cave shelters a strip of corrugated iron is placed on top of the cap of the frame. The sheeting is then driven over the top of the iron. The space between caps is filled with an additional piece of corrugated iron which is supported by the sprags (see fig. 147). Seepage is thus carried to the sides of the chamber where it is collected in a gutter leading to a sump.

*c. Removal of water from chambers and galleries.*—Such water as gains entrance to chambers and galleries in spite of precautions must be taken care of or it will collect and flood the shelter. Galleries should always be driven on a 1-percent, or 1 foot to 100 feet, grade longitudinally and all slopes should fall toward a point or points where the water can be disposed of. If the shelter has a level entrance such as might occur in a reverse slope location, nothing is required except to regulate the slopes so that all water will run to the mouth. Using a 1-percent slope, the floor of the gallery should be sloped laterally and a gutter formed along one side. If the shelter is entered by an incline or shaft, a pit or sump must be formed at the bottom into which water can collect, and from which it can be raised to the surface by pumping, siphoning, or bailing.

■ 60. VENTILATION.—Ventilation, particularly in reference to cave shelters, is very important and should be given careful consideration. It includes the following problems:

a. Providing a sufficient circulation of fresh air through the incline, shafts, galleries, and chamber.

b. Gasproofing, or exclusion of gas from all parts of the shelter.

c. Providing a supply of pure air by means of air purifiers when entrances and ventilation shafts are closed during a prolonged gas attack.

■ 61. CIRCULATION OF FRESH AIR.—a. In the case of surface and cut-and-cover shelters no serious difficulties arise, and the problem may be handled usually by keeping entrances open.

b. In the case of cave shelters ventilating shafts in addition to entrances are usually necessary. They are in the form of small vertical shafts which may be bored from within after completion of the shelter. A stovepipe through one of these shafts assists circulation of air materially. In some cases where the ventilating shaft is not provided, a small fire near one of the entrances will create a draft and thus keep the air purified. In very large and elaborate systems of shelters a forced draft may be caused by means of fans.

c. A gallery should not be driven more than 60 feet without artificial ventilation. The only possible way of ventilating a gallery with a single opening is to force fresh air to the working breast which may be done through a duct of wood or metal, or canvas or other hose. A pressure blower worked by hand or power is among the essential items of mining equipment. For excavations of moderate extent a portable forge forms a convenient ventilating device. If a gallery passes under surface cover, drill holes made through the roof and breaking the surface under protection of the cover may be used to promote ventilation. In a system of galleries having two or more outlets, air may be exhausted from one and drawn in through the other. Screens or doors may be arranged to compel desired distribution of fresh air. Vacuum operation is never as satisfactory as a pressure system.

■ 62. GASPROOFING.—*a.* Due to their low level protected shelters are particularly subject to gas concentration, and in all cases protection must be provided by means of curtains in entrances. During extended gas attacks men must be enabled to work and rest inside the shelter with their gas masks off. This is most important in shelters where men are placed pending evacuation who are so wounded that they cannot wear a gas mask, in shelters used for medical dressing stations, telephone central and signal stations, observation posts, headquarters, and other activities whose efficiency would be considerably reduced by wearing the gas mask.

*b.* Adjustable curtains made from wool or cotton blankets and supported on a light, sloping framework are the most effective means of excluding gas from shelters. The curtain and framework must be assembled at the shelter site and built to fit each shelter.

*c.* Gas curtains *must* be—

- (1) Impervious to gas.
- (2) Of the simplest possible construction.
- (3) Such as to permit rapid exit in case of a raid.
- (4) Readily rolled up and put out of the way when not in use.
- (5) So arranged as to drop in place instantly.

Ordinary blankets soaked with water or oil may be used. A more efficient curtain than this is needed and experiments to date indicate that a wool or cotton blanket faced with an impermeable fabric or impregnated with a suitable chemical agent will be provided.

*d.* *Curtain frames* should be nailed securely to the sides and top of the entrance timbers, close-timbered for this purpose. It is sometimes necessary to place curtain frames on the steps, but they should be placed in horizontal entrances or horizontal approaches to inclines whenever possible. The curtain frame for stairways (fig. 152) is similar to that used for horizontal entrances.

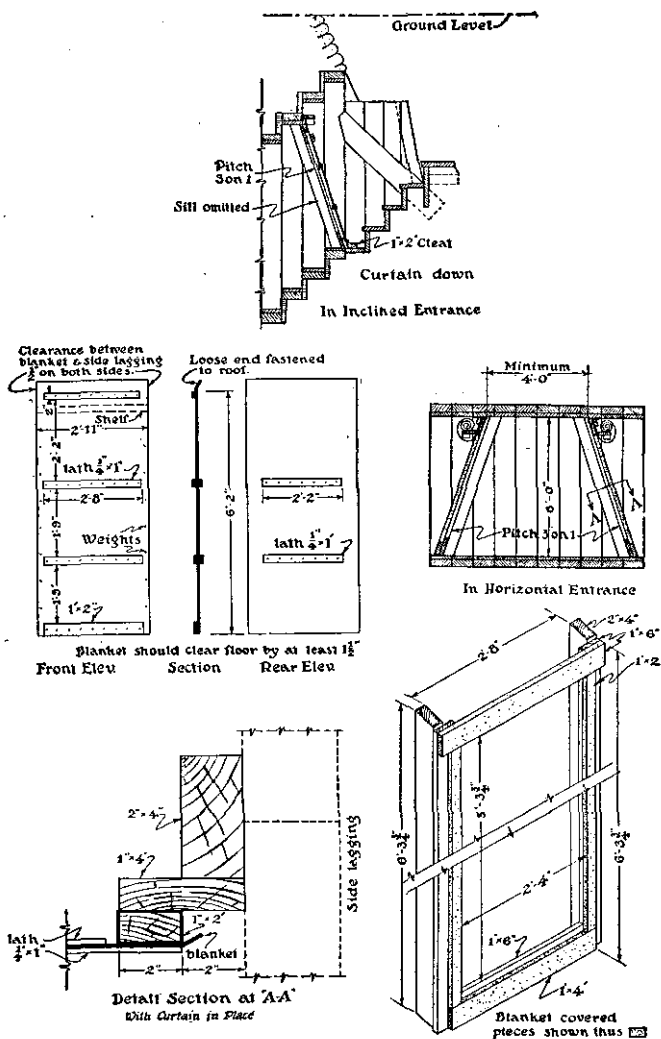

FIGURE 152.—Gas curtain details.

TABLE XLI.—Material list, gas curtain for protected shelters (fig. 152)

Item	Size	Unit	Quantity
<b>Curtain:</b>			
Blanket.....	6 by 7 feet.....	Each.....	1
Tacks.....	.....	Package.....	2
Nails.....	Tenpenny.....	Pound.....	2
Small weights.....	.....	Each.....	16
Laths.....	½ by 1 by 2 feet 8 inches.....	do.....	2
Do.....	1½ by 1 by 2 feet 2 inches.....	do.....	2
Bottom strip.....	1 by 2 by 2 feet 8 inches.....	do.....	1
Top cleat.....	1 by 2 by 2 feet 11 inches.....	do.....	1
<b>Frame:</b>			
Frame pieces, front.....	2 by 4 by 16 feet.....	do.....	1
Sash.....	1 by 4 by 16 feet.....	do.....	1
Molding.....	1 by 2 by 16 feet.....	do.....	1
Top and shelf.....	1 by 6 by 8 feet.....	do.....	1
Furring.....	1 by 2 by 12 feet.....	do.....	2
Nails.....	Tenpenny.....	Pound.....	1
Do.....	Twentypenny.....	do.....	2

e. Front, rear, and side views of the curtain are shown in figure 152. The curtain is fastened to the frame at the top by a cleat. Three inches of blanket material are left projecting above the top of this cleat to be later fastened tightly to the underside of the cap. The 1-inch by 2-inch strip at the bottom of the blanket must be of perfectly straight material, and when it becomes warped it should be replaced immediately. When used in an incline this cleat is allowed to rest on the floor of the steps and the curtain should clear the side lagging by ½ inch. Judgment should be used in cutting the blanket to the proper size in an opening. Weights made from nuts, washers, scraps of iron, bullets, etc., are fastened along the side edges of the curtain. Gas curtains should clear the side lagging by ½ inch and the floor by 1½ inches when placed in horizontal entrance approach. When not in use the blanket is rolled up and placed on the shelf at the top of the frame.

f. Number and position of curtains.—There should be two gas curtains in every entrance in order to make a gas trap or space between the two and permit entry and exit during



attack without allowing an appreciable amount of the gas to get into the dugout. The curtain frame should be set on a slope of 3 on 1. Whenever possible curtain frames should slope in opposite directions with curtain on the outside (see fig. 152). The space between the two blankets should be as great as possible in order to secure maximum dilution of the gas which will inevitably get in. In first-aid stations curtains are placed at least 8 feet apart or at top and bottom of the incline. In short horizontal entrances the curtains are necessarily closer to one another, but the space should be as great as possible and never less than 4 feet at the top.

*g. Other openings.*—Curtains may be made for windows in the same manner as for entrances, except that only one curtain need be installed. Holes made for periscopes and for ventilation purposes should have blanket-covered plugs hanging nearby to stop up the openings in case of a gas attack. Old clothes may also be used. Any openings behind entrance timbers should be filled with clay, old clothes, or sandbags. All crevices around the curtain frame in either the frame or entrance timbers should be calked with pieces of blanket. Unless this is done the curtains are useless. If a dugout is not practically gastight, all pretense of protection should be removed.

*h. Flooring or steps in front of a gas curtain* should be kept clear of all mud or refuse. The seal between curtains and frames is more effective if the curtains and frames are kept moist at all times. They should be sprayed daily with water or with gasproofing solutions which should always be kept on hand. A pail or other container filled with fresh chloride of lime should be kept on hand at all times in gasproof dugouts. During gas attacks or when men have been exposed to gassed terrain, the chloride of lime container should be opened and placed in the gas trap between the curtains for use of all personnel entering the dugout to destroy mustard gas on the feet or hands. Mustard gas or similar agent carried into a dugout soon converts the dugout into a gas trap.

■ 63. AIR SUPPLY DURING GAS ATTACK.—*a.* In any future use of chemical agents in war, such agents will in all probability be used to maintain a continuous concentration in certain areas for comparatively long periods of time. Assuming that

1 cubic yard of air is sufficient for one man for 2 hours, the air in an occupied shelter would become unfit for breathing within 4 or 5 hours after the gas curtains were closed. For this reason it is important to determine the best methods of supplying fresh air by means of air filters and forced feed during such periods of gas concentration. It is necessary to build up a slight positive air pressure within the dugout, first, to prevent seepages of gas through cracks that cannot be closed, and second, to prevent gas being brought in by a rush of air when personnel enter or leave the dugout.

b. *This positive pressure* may be secured by means of a collective protector which introduces filtered air into the dugout on the principle of the gas mask and provides a current of air passing from the inside of the dugout to the outside through the minute openings which might otherwise allow entrance of gas from the outside.

c. *Field collective protector.*—A field collective protector has been standardized. It consists primarily of a purifying unit (canister) and a gasoline engine-driven blower both mounted on a common base. A long hose extends from the collective protector for the purpose of delivering purified air into the protected space. The collective protector may be transported by truck and has a capacity of approximately 200 cubic feet of purified air per minute.

■ 64. FLOOR SPACE.—The following table gives data from which amount of shelter construction necessary may be approximated. For types of command posts see paragraphs 39c, 57e, and 58f.

	<i>Square feet</i>
Troops, per man occupying_____	9 to 12
First-aid station, per litter_____	28
Command post:	
Platoon _____	100
Company _____	200
Battalion _____	400
Regiment _____	600
Brigade _____	800
Division _____	1,600

■ 65. TIME FOR CONSTRUCTION.—*a.* Table XLII gives estimates for construction time for various shelters as illustrated in this section. Estimates are based on assumption of average firm soil, well-trained men, and material delivered at site. They include time of the labor required to dispose of excavated material and to handle construction material. The area used is that of the room providing shelter and does not include areas in passageways or inclines. Estimates are subject to considerable uncertainty on account of the variety of conditions encountered.

*b.* With men untrained in this character of work the man-hours per square foot of chamber may be increased 50 percent; after a period of experience, however, a detail should approach the estimate. Time of construction may be shortened by increasing size of the detail where conditions of work make this possible.

## FIELD FORTIFICATIONS

65

TABLE XLII.—Shelter construction data, average soil, material at site

Type	Figure No.	Description	Protects against shell	Capacity (men)	Work detail	Square feet	Material			Construction time			Per occupant	
							Tons	Tons per occupant	Tons per square foot	Man-hours	Man-hours per square foot	Man-hours per occupant	Excavation (cu-bic feet)	Feet (board measure)
Surface.....	123	Corrugated steel.	3-inch.....	12	1 sergeant, 2 squads.	150	101	8.5	0.68	330	2.0	28	36	82
Cut and cover.	127	Splinter proof.	Splinters and fragments.	2	2 men.....	18	.5	.25	.03	8	.4	4	66	.....
Do.....	128	Light timber.	3-inch.....	2	do.....	20	2	1	.1	10	.5	5	39	171
Do.....	129	Light steel	do.....	2	do.....	27	2	1	.08	12	.5	6	45	74
Do.....	130	Timber.....	6-inch.....	24	1 sergeant, 2 squads.	234	562	24	2.4	2,100	9	88	240	250
Do.....	131	Steel.....	do.....	24	do.....	290	459	19	1.6	1,900	6.5	80	230	142
Do.....	132	Concrete	10-inch.....	50	do.....	825	1,083	122	1.3	3,800	4.6	76	286	148
Cave.....	146	Recess.....	Depends on depth.	30	1 sergeant, 16 men.	240	27	.9	.1	2,300	9.6	77	130	328
Do.....	147	Gallery.....	do.....	24	do.....	234	28	1.2	.1	2,300	9.9	96	108	448

<sup>1</sup> Based on a capacity of 50 men, if for shelter, or 43.5 tons per person if shelter is designed for staff use of about 25 persons.

<sup>2</sup> For forms.

## SECTION IX

## SUMMARY

■ 66. GENERAL.—*a.* Field fortifications, hasty or deliberate, are generally laid out and constructed by the occupying troops.

*b.* Engineers assist field fortification work by—

- (1) Supply of tools and materials.
- (2) Execution of works of general use.
- (3) Lay-out and construction of rear positions.

*c.* Field fortification works consist of fox holes, trenches, obstacles against both foot and mechanized troops, weapon emplacements, protected shelters, clear fields of fire, and camouflage.

*d.* Open works protect against light artillery and fragmentation bombs, covered works generally against medium shells or bombs.

*e.* Allow for effects of surface and ground water and type of soil to be encountered in siting and constructing field works.

*f.* Use existing terrain features to reduce fortification work.

■ 67. TERRAIN APPRECIATION.—*a.* Evaluate terrain in terms of observation, fields of fire, cover and concealment, obstacles, and communications; of these, observation is usually the more important.

*b.* A terrain compartment is an area bordered on at least two sides (opposite sides) by terrain features which prevent ground observation into the area. It may form either a corridor or a cross compartment.

*c.* Boundaries in attack should coincide with boundaries of corridors.

*d.* Boundaries in defense should fall between corridor boundaries so as to assign avenues of approach to units most affected thereby.

*e.* A cross compartment favors the defense.

*f.* To assist terrain studies on map or photograph, one or all of the following devices may be used: emphasize drainage lines, add ridge lines, emphasize certain contours, see TM 5-220.

*g.* On tactical studies of terrain see FM 101-5 for details.

■ 68. ORGANIZATION OF THE GROUND.—*a.* To develop full strength of a defensive position—

- (1) Dispose troops so their fires are coordinated.
- (2) Provide fields of fire.
- (3) Construct field fortifications.

*b.* Use hasty fortifications when under fire or threat of fire, deliberate when out of contact with the enemy.

*c.* Develop hasty fortifications into deliberate types as time permits.

*d.* A battle position consists of a system of mutually supporting defensive areas organized in depth, as follows:

(1) *Platoon defense area.*—Smallest defensive area, garrison usually a platoon.

(2) *Company defense area.*—Two or more platoon defense areas under a company commander.

(3) *Battalion defense area.*—Two or more company defense areas under a battalion commander. It is the basic unit of defense, and can defend on average terrain a front of 800 to 1,500 yards, depending on terrain and tactical situation.

(4) *Regimental sector.*—Front defended by a regiment, completely covering battle position in depth.

*e.* A battle position contains three echelons of defensive areas, the main line of resistance (MLR), the battalion reserve area, and the regimental reserve line (RRL). Minimum distance between the MLR and RRL is 700 yards, maximum, 1,800 yards.

*f.* A battle position should when practicable be protected by an organized outpost area well to the front; it may be reinforced by one or more reserve battle positions connected by switch positions.

■ 69. EFFECTS OF PROJECTILES.—*a.* For protection against caliber .30 to .50 bullets, special steel or (tank) armor about four times their caliber in thickness is required; they penetrate steel twice their caliber in thickness.

*b.* The greatest destructive effect is produced by the larger projectiles with long delay fuses striking at angles of impact over 40° giving maximum penetration such as those dropped from aircraft and fired from 155-mm or larger howitzers.

■ 70. TRENCHES.—*a.* For protection, troops may have to work at night.

b. No night work should be performed that can safely be done by day.

c. *Hasty trenches*.—(1) *Skirmisher trench*, protection from small-arms fire only.

(2) *Fox hole* (when completed to standing type), protection against small-arms and light artillery fire.

(3) *Shell holes*, quick protection with little labor.

(4) *Slit trenches*, protection for machine-gun and artillery personnel.

d. *Clearing fields of fire*.—(1) Leave a thin natural screen to hide defender's position.

(2) Clear thick brushwood and undergrowth and leave overhead cover.

(3) Leave large scattered trees standing, cutting off only the lower branches.

(4) Demolish walls only when resulting debris will not give more protection than the wall itself.

(5) Buildings, knock down low ones, leave large ones standing and burn them.

e. (1) *Tracing of deliberate trenches* should be supervised by an officer.

(2) The *octagonal* trace is the best fire trench and the *wavy* trace is the best communication trench. The *zigzag* trace is the simplest, easiest to construct and maintain, and can be used as a fire or communication trench or as the *echelon* trace in gaining ground toward or away from the enemy.

f. *Standard profiles*.—The *simple standing* trench is first profile sought when constructing trenches rapidly. Develop it to *type A* which is standard for hard ground. Develop *type A* to *type B* in soft ground. *Type C wide communication trench* is used in special cases for main thoroughfares.

g. *Planning and reconnaissance*.—Must be careful and thorough. Data required: trench locations, profile to be used, amounts of time, labor, tools, and materials required, and covering force, if any.

h. *Trench drainage*.—(1) Prepare drainage plans and complete essential drainage work before starting other work.

(2) Exclude surface water from trenches.

(3) Dispose of water by drainage ditches, sumps, pumping, or bailing.

(4) Provide trench bottom with minimum slope of 1 percent with no low spots.

(5) Site trenches to drain toward natural drainage lines.

*i. Revetments may be—*

(1) *Retaining wall type*, usually of sandbags, for fills, parapets, and breastworks.

(2) *Surface type*, consisting of revetting material such as wire netting, brush, etc., and its supports, and used mainly in retaining the slopes of trenches. A-frames are standard supports.

*j. Breastworks* are built above ground where water, rock, or very hard material makes trench excavation impracticable.

*k. Trench accessories.—*(1) *Observation posts* should give—

(a) Maximum clear field of view.

(b) Immunity from enemy fire which is best obtained by concealment.

(2) *Latrines.—*Provide for—

(a) At least 4 percent of the command.

(b) If occupied for any considerable time, for 8 percent of the command.

(3) *Sign posting.—*Checked or provided in new areas.

■ 71. OBSTACLES.—*a. General.—*(1) Take maximum advantage of natural obstacles.

(2) Barbed wire most effective artificial obstacle against foot troops.

(3) Double-apron fence most effective pound for pound and is standard tactical obstacle.

(4) Typical protective obstacle, four-strand fence completely surrounding locality.

*b. Location and construction of artificial obstacles.—*(1) Cover by defensive fires.

(2) Keep protective obstacles always under observation within 100 yards.

(3) Conceal obstacles by natural features.

(4) Provide all around protection not closer than 30 yards.

(5) Use belts 4 to 10 yards with intervals of 15 to 40 yards.



*c. Entanglement material requirements for a defensive position.*—(1) Weight of tactical wire (double-apron fence) equals weight of protective wire (four-strand fence).

(2) Linear yards of tactical obstacle equals  $1\frac{1}{4}$  times frontage.

(3) Linear yard of protective obstacle equals  $3\frac{1}{8}$  times frontage.

(4) Tactical wire weighs 10 pounds and protective wire weighs 4 pounds per linear yard of obstacle.

(5) Battalion area with frontage of 1,500 yards requires about 20 tons of pickets, wire, etc., for double-apron tactical and four-strand fence protective entanglements.

*d. Dead abatis.*—(1) Interlace branches, cut trees partially through 2 to 3 feet above ground.

(2) Addition of barbed wire increases effectiveness of the obstacle.

*e. Inundations.*—Barbed wire and artificial obstacles increase their effectiveness.

*f. Underwater beach obstacles.*—(1) Require utmost ingenuity; must be adapted to local conditions.

(2) Barbed wire when used must be more plentiful and more securely anchored than for land obstacles.

■ 72. EMPLACEMENTS.—*a. For infantry weapons.*—(1) Automatic rifle emplacements are used in trenches or fox holes.

(2) Machine guns are habitually used in emplacements.

(3) In *hasty emplacements* concealment is of paramount importance and as much protection as possible (may be nearby slit trenches) is provided.

(4) In *deliberate emplacements* more physical protection for personnel is provided either at the gun position or nearby. Concealment is still of considerable importance.

*b. For field artillery.*—(1) *Light artillery* seldom dig in except for deliberate positions.

(2) *Banks*, particularly along roads, especially adapted to construction of artillery emplacements in them.

(3) *Trenches for cannoners* and *parapets* follow after construction of the gun emplacement.

*c. For anti-aircraft.*—(1) Concealment and camouflage are most important.

(2) *Sunken emplacements* or *parapets* constructed when possible.

(3) *Parapets* provide splinterproof protection as a minimum.

■ 73. PROTECTED SHELTERS.—*a. Choice of type depends on—*

- (1) Use to be made of shelter.
- (2) Degree of protection necessary.
- (3) Terrain.
- (4) Location.
- (5) Cover and concealment.
- (6) Observation.
- (7) Time, material, and labor available.
- (8) Ground and subsurface conditions.

*b. Application of types.—*(1) *Splinterproof or light shelters* used in advanced positions in early stages of organization of the ground in mobile situations.

(2) These may be developed into light shellproof shelters as time permits or light shellproof shelters may be built initially for rear positions.

(3) *Heavy shellproof and cave shelters* used only in stabilized situations.

*c. Overhead cover* must provide for—

- (1) Bursting layer.
- (2) Distributing layers.
- (3) Intermediate shock absorbing layers.

*d. High early strength cement* materially reduces construction time. Attains adequate strength in about  $\frac{1}{15}$  of the time for standard cement.

*e. Surface shelters* may be—

(1) Concealed in woods or behind reverse slopes; these may vary from the hasty splinterproof type to light shellproof type.

(2) Reinforced buildings in a village and should be generally of at least the light shellproof type.

(3) Concrete providing at least light shellproof protection.

(4) Small light shelters for protection of ammunition and stores.

*f. Artillery ammunition shelters* must be waterproof; concealment and storage below ground level are desirable.

*g. Cut-and-cover shelters.*—Depth of excavation greater than about 12 feet impracticable. If greater depth needed use mining methods (cave shelter).

*h. Cave shelters.*—(1) Two types are—

(a) Recess.

(b) Gallery.

(2) Entrances must be concealed and protected.

(3) Emergency exits must be provided.

(4) Ventilation, drainage, and gasproofing are particularly important.

*i. Drainage.*—(1) Exclude surface water.

(2) Exclude all *seepage* possible and collect balance in a sump to be pumped out.

(3) Give galleries a minimum 1 percent slope longitudinally and laterally.

*j. Ventilation.*—Obtained by ventilation shafts and power or hand blowers.

*k. Gasproofing is obtained by*—(1) Gas curtains to exclude gas.

(2) Collective protectors to supply pure air.

■ 74. GENERAL RULES FOR EXECUTION OF FIELD WORKS.—General rules applicable to all details of field fortifications are—

*a.* Assign each organization to construction of the works it will itself occupy and defend and for which it is best equipped and trained. Assign work of general interest such as clearing fields of fire, improvement of routes, etc., to special units and attached troops.

*b.* Avoid splitting of units or violation of tactical integrity. Use complete squads, platoons, and companies whenever possible. Assign a unit to groups of similar tasks all in the same locality.

*c.* Without enough men to finish all tasks in the allotted time, make sure that the most important tasks will be completed on time, and others as far as possible in order of importance.

*d.* To observe all of the foregoing rules precisely will never be possible. Each should be given all the weight that the situation permits.

## INDEX

	Paragraph	Page
Abatis .....	43	149
Accessories, trench .....	39	105
Air:		
Fresh, circulation in protected shelters .....	61	278
Supply during gas attack .....	63	282
Aircraft projectiles, effect of .....	29	45
Antiaircraft matériel emplacements .....	50	201
Areas:		
Defense:		
Battalion .....	20	31
Company .....	19	30
Platoon .....	18	29
Outpost .....	24	37
Artillery—		
Ammunition shelters, protected .....	56	225
Emplacements .....	49	186
Projectiles, effect of .....	29	45
Support .....	23	36
Barbed wire obstacles .....	42	118
Battalion defense area .....	20	31
Battle position .....	17	25
Reserve .....	25	41
Breastworks .....	38	103
Cave shelters .....	58	240
Company defense area .....	19	30
Compartments, terrain .....	10	8
Cross, influence of .....	12	20
Construction—		
Materials for protected shelters, standard .....	54	219
Of obstacles, basis .....	41	117
Time, protected shelters .....	65	284
Corridors, terrain, influence of .....	11	12
Cover, overhead .....	53	213
Cut-and-cover protected shelters .....	57	226
Defense areas:		
Battalion .....	20	31
Company .....	19	30
Platoon .....	18	29
Definitions .....	1	1
Deliberate—		
Fortifications, use .....	16	25
Trenches .....	35	68
Design:		
Field fortifications, natural conditions affect-		
ing .....	6	4
Obstacles, basis .....	41	117
Drainage:		
Protected shelters .....	59	276
Trenches .....	36	87

INDEX

	Paragraph	Page
Effects of projectiles.....	27-29, 69	42-60, 287
Emplacements.....	48-50, 72	158-201, 290
Antiaircraft matériel.....	50	201
Artillery.....	49	186
Infantry weapons.....	48	158
Factors, terrain.....	9	6
Field works, general rules for execution.....	74	292
Floor space in protected shelters.....	64	283
Fortifications:		
Deliberate.....	16	25
Field.....	66	286
Definitions.....	1	1
Design and location, natural conditions affecting.....	6	4
Effectiveness against projectiles and bombs.....	5	3
Employment.....	2	1
Execution.....	3	2
Nature of work.....	4	2
Use of existing terrain features.....	7	5
Hasty.....	15	23
Fresh air circulation in protected shelters.....	61	278
Gasproofing protected shelters.....	62	279
Ground organization.....	14-26, 68	21-42, 287
Hasty--		
Fortifications, use.....	15	23
Trenches.....	34	63
Infantry weapon--		
Emplacements.....	48	158
Projectiles, effect of.....	28	43
Inundations.....	44	152
Location of--		
Field fortifications, natural conditions affecting.....	6	4
Obstacles, basis.....	41	117
Obstacles.....	40-47, 71	117-157 289
Abatis.....	43	149
Barbed wire.....	42	118
Classification.....	40	117
Construction, basis of design, and location.....	41	117
Inundation.....	44	152
Tank.....	46	157
Underwater.....	45	153
Organization of the ground.....	14-26, 68	21-42, 287
Outpost area.....	24	37
Overhead cover.....	53	213
Platoon defense area.....	18	29
Positions:		
Battle.....	17	25
Reserve.....	25	41
Switch.....	26	42

INDEX

	Paragraph	Page
Profile, trench .....	31	60
Projectiles, effect of .....	27-29, 69	42-60, 287
Artillery and aircraft .....	29	45
Infantry weapon .....	28	43
Protected shelters .....	51-65, 73	206-285, 291
Regimental sectors .....	21	35
Reserve battle positions .....	25	41
Revetments, trench .....	37	92
Sectors, regimental .....	21	35
Shelters, protected .....	51-65, 73	206-285, 291
Air—		
Circulation in, fresh .....	61	271
Supply during gas attack .....	63	282
Ammunition, artillery .....	56	225
Cave .....	58	240
Classification .....	51	206
Construction—		
Materials, standard .....	54	219
Time .....	65	284
Cut-and-cover .....	57	226
Drainage .....	59	276
Floor space .....	64	283
Gasproofing .....	62	279
Overhead cover .....	53	213
Surface .....	55	220
Types, choice of .....	52	209
Ventilation .....	60	278
Support, artillery .....	23	36
Switch positions .....	26	42
Tank obstacles .....	46	157
Terrain—		
Appreciation .....	8-13, 67	6-21, 286
Compartments .....	10	8
Cross, influence of .....	12	20
Corridors, influence of .....	11	12
Factors .....	9	6
Features, existing, use in field fortifications .....	7	5
Study aids .....	13	20
Trenches .....	30-39, 70	60-116, 287
Accessories .....	39	105
Breastworks .....	38	103
Classification .....	33	61
Deliberate .....	35	68
Drainage .....	36	87
Hasty .....	34	63
Revetments .....	37	92
Standard types, necessity for .....	32	61
Trace, tracing, and profile .....	31	60
Underwater obstacles .....	45	153
Ventilation of protected shelters .....	60	278

## INDEX

	Paragraph	Page
Weapon—		
Emplacements, infantry .....	48	158
Projectiles, infantry, effects of .....	28	43
Wire obstacles, barbed .....	42	118
Works, field, general rules for execution .....	74	292

