

FM 5-15

WAR DEPARTMENT FIELD MANUAL

CORPS OF ENGINEERS

FIELD

FORTIFICATIONS

WAR DEPARTMENT : 14 FEBRUARY, 1944

WAR DEPARTMENT FIELD MANUAL
FM 5-15

This manual supersedes FM 5-15, 1 October 1940, including C 1, 2 April 1941, and C 2, 10 December 1941; and so much of Training Circular No. 52, War Department, 1942, as pertains to FM 5-15; Training Circular No. 96, War Department, 1943.

CORPS OF ENGINEERS

FIELD
FORTIFICATIONS



WAR DEPARTMENT • 14 FEBRUARY 1944

WAR DEPARTMENT,
WASHINGTON 25, D. C., 14 February 1944.

FM 5-15, Corps of Engineers Field Manual, Field Fortifications, is published for the information and guidance of all concerned.

[A. G. 300.7 (16 Jun 43).]

BY ORDER OF THE SECRETARY OF WAR:

G. C. MARSHALL,
Chief of Staff.

OFFICIAL:

J. A. ULIO,
Major General,
The Adjutant General.

DISTRIBUTION:

B and H 1, 2, 4, 6, 7, 17, 44 (4); R 1-4, 6, 7, 17, 18,
44 (5); Bn and H 5, 19 (5); C 5 (10).
(For explanation of symbols see FM 21-6.)

CONTENTS

	<i>Paragraphs</i>	<i>Page</i>
CHAPTER 1. GENERAL	1-2	1
CHAPTER 2. TERRAIN EVALUATION.		
<i>Section I. General</i>	3-9	3
II. Aids to the study of terrain....	10-11	7
III. Tactical study of terrain.....	12-17	23
CHAPTER 3. GENERAL FORTIFICATION TECHNIQUE.		
<i>Section I. Tools and materials</i>	18-19	26
II. General technique.....	20-27	28
CHAPTER 4. ENTRENCHMENTS AND EMPLACEMENTS.		
<i>Section I. General</i>	28-29	47
II. Infantry entrenchments for hasty fortifications.....	30-36	48
III. Infantry weapon emplace- ments.....	37-46	58
IV. Special and standard trench....	47-48	81
V. Field artillery emplacements....	49-57	86
VI. Antiaircraft artillery emplace- ments.....	58-65	102
CHAPTER 5. SHELTERS.		
<i>Section I. General</i>	66-72	126
II. Surface shelters.....	73-74	156
III. Cut-and-cover shelters.....	75-76	165
IV. Cave shelters.....	77-92	181
APPENDIX I. Glossary of terms		221
II. Effects of bombs and projec- tiles.....	1-3	224
III. Concrete machine-gun em- placement.....	1-4	229
IV. 40-mm Antiaircraft tower....	1-3	236
INDEX		269

CHAPTER 1

GENERAL

1. PURPOSE AND SCOPE. Troops in occupied positions increase their combat effectiveness by works of an engineering nature called field fortifications. This manual describes field fortification methods and gives details of construction of entrenchments, emplacements, and shelters. It also outlines the principles of terrain appreciation which apply to field fortifications, and explains how to combine individual field fortifications into a unified system by means of organization of the ground. It does not cover the subject of obstacles, which is treated in FM 5-30.

2. CLASSIFICATION AND USE OF FIELD FORTIFICATIONS. **a. Classification.** There are two general classes of field fortifications.

(1) Hasty fortifications. Those initially constructed when in contact with the enemy or when contact is imminent. They consist generally of light clearing of fields of fire, foxholes for personnel, open weapon emplacements, hasty antitank and antipersonnel mine fields, barbed-wire entanglements, strengthening of natural obstacles, observation posts, and camouflage.

(2) Deliberate fortifications. Those constructed out of contact with the enemy, or developed gradually

from hasty fortifications. They include deliberate entrenchments, antitank and antipersonnel mine fields, antitank obstacles, covered weapon emplacements, barbed-wire entanglements, troop shelters which are proof against artillery fire and weather, extensive signal communication systems, gasproof inclosures of command posts and aid stations, and elaborate camouflage.

b. Use. Field fortifications increase the combat efficiency of troops. They must be used skillfully to further the mission of a unit, and must not be allowed to lead to a passive or static defense. The decisions as to whether or not to occupy a position and the degree of fortification to undertake are primarily tactical and beyond the scope of this manual.

CHAPTER 2

TERRAIN EVALUATION

SECTION I

GENERAL

3. PURPOSE. The purpose of this chapter is to describe the means of evaluating terrain. For a detailed discussion of the effect of terrain on tactical dispositions and for information on organization of the ground, see FM 100-5, 7-10, 7-15, 7-20, and 7-40.

4. DEFINITIONS. **a. Terrain,** from a military viewpoint, is an area of ground considered in relation to its use for military purposes.

b. Terrain evaluation is the analysis of the area of probable military operations, to determine the effect of the terrain on the lines of action open to opposing forces in the area.

5. INFLUENCE OF TERRAIN. **a.** The character of the area or region of military operations often has a decisive influence upon the course of operations. The more important factors to be considered in evaluating terrain include not only natural features, such as ridges,

streams, bodies of water, woods, and open spaces, but also such features as roads, railways, and towns.

b. Ground forms, such as a succession of ridges and valleys, influence military operations by aiding or hampering the movement of military forces. An advance parallel to the ridges and valleys is mechanically easier than movement across successive ridges.

c. The salient feature of a commander's plan of action are usually determined so as to take full advantage of favorable terrain features.

6. TERRAIN FACTORS. Regardless of the type of terrain and the tactical situation, terrain always can be evaluated in terms of the following five factors: observation, fields of fire, concealment and cover, obstacles, and communications.

a. Observation. Observation of the ground on which a fight is taking place is essential in order to bring effective fire to bear upon the enemy. Observation also aids in increasing the effectiveness of fire directed on an enemy stopped by obstacles. The value of cover and concealment is based on denial of observation to the enemy. Observation also affords information as to what both enemy and friendly troops are doing, making it possible for the commander to control more effectively the operations of his troops.

b. Fields of fire. Fields of fire are essential to the defense. An ideal field of fire for infantry is an open stretch of ground in which the enemy can be seen and in which he has no protection from fire as far as the limits of effective range of the infantry weapons. Fields of fire can be improved by cutting or burning weeds, grass, and crops; clearing brush and trees; demolishing buildings; and cutting lanes through woods.

However, concealment must be carefully considered in all such work. The time and labor available for this type of improvement should be considered in evaluating the terrain.

c. Concealment and cover. Concealment from view, both from the air and ground, will usually protect military personnel and installations only as long as the enemy is unaware of their location. Unconcealed installations and troops invite destruction. Cover includes protection from fire, either that provided by the terrain, or that provided by other natural or artificial means.

d. Obstacles. Obstacles are obstructions to the movement of military forces. Some of the common natural obstacles of military value are mountains, rivers, streams, bodies of water, marshes, gullies, steep inclines, and heavily wooded terrain. Proper evaluation of natural obstacles permits the most effective use of artificial obstacles.

(1) Mountains parallel to the direction of advance of a force limit or prohibit lateral movement and protect the flanks; perpendicular to the advance, they are an obstacle to the attacker and an aid to the defender.

(2) Rivers are similar to mountains in their effect on forces moving parallel and perpendicular to them. Rivers flowing parallel to the advance may be used as routes of supply.

(3) Marshes frequently provide more delay to an *advance than bodies of water*, because generally it is more difficult to build causeways than bridges. Mechanized vehicles can be restricted in movement by dense woods, marshes, steep inclines, gullies, stumps, large rocks, and bodies of water.

e. Communications. Communications consist of

roads, railroads, waterways, airways, and their facilities. They are important to both offense and defense for moving troops and supplies. In most situations, especially in the operations of large bodies of troops, the means of communication are of vital importance. The existing ones generally must be studied thoroughly and utilized to the maximum before new ones are constructed.

7. OBJECTIVES. Terrain objectives, normally, are clearly defined features, the capture of which will insure the defeat of a hostile force, or from which the operation can be continued or the success exploited. Terrain objectives, in the attack by ground forces, usually are located in, or in rear of, the hostile artillery area. One may be a terrain feature affording command observation, another a critical point in the hostile command system or on essential supply routes, and another an obstacle to armored forces. In some situations the objective is clearly indicated by the mission; in others it is deduced from the situation.

8. MAPS AND RECONNAISSANCE. Maps are the basis for terrain studies but should be checked by air reconnaissance, air photographs, and ground reconnaissance. Works of man, especially routes of communication, are changing constantly; and even natural ground forms may change.

9. CORRIDORS. Features such as ridges, streams, woods, roads, and towns divide all terrain into more or less separate areas. Such an area frequently consists of a valley lying between two ridges or an open space between two wooded areas. The limiting features pre-

vent direct fire or ground observation into the area; they may be high or low, continuous or discontinuous. When the longer axis of such an area extends in the direction of movement of a force, or leads toward or into a position, the area is called a *corridor*.

SECTION II

AIDS TO THE STUDY OF TERRAIN

10. GENERAL. Maps and aerial photographs, supplemented by ground and air reconnaissance, form the basis for studying terrain. In many cases maps marked in special ways simplify its study. Often a series of special maps, on each of which is emphasized a separate item of military importance such as roads, streams, or ridges, is necessary. The purpose of this section is to indicate methods used in preparing such maps.

11. FEATURES OF MILITARY IMPORTANCE. a.
Ground forms. Drainage lines and ridge lines are the natural basis for studying terrain with respect to the shape of the ground. Drainage lines always form a connected system or systems of branching lines. Ridge lines form similar systems of branching lines. Together, ridge and drainage lines form two interlocking branching systems which, singly or together, clearly indicate the general shape of the ground.

(1) Figures 1 ① shows a section of a contoured map. Figure 1 ② is the same map with the drainage lines emphasized. This is generally done in blue. Figure 1 ③



① Section of contoured map before emphasis.

Figure 1.

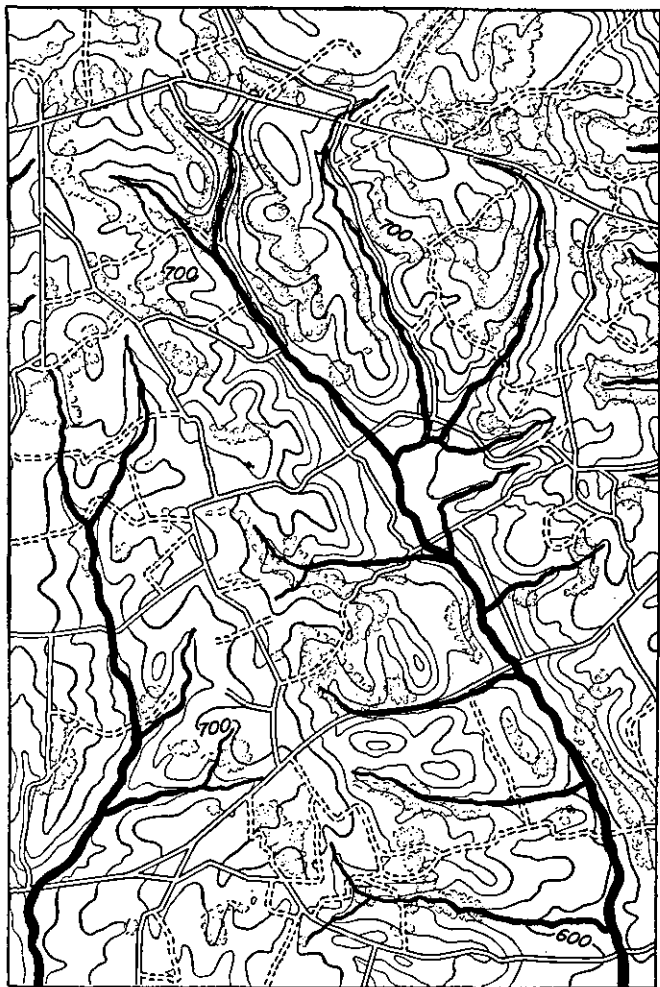

② Drainage lines emphasized.

Figure 1—Continued.

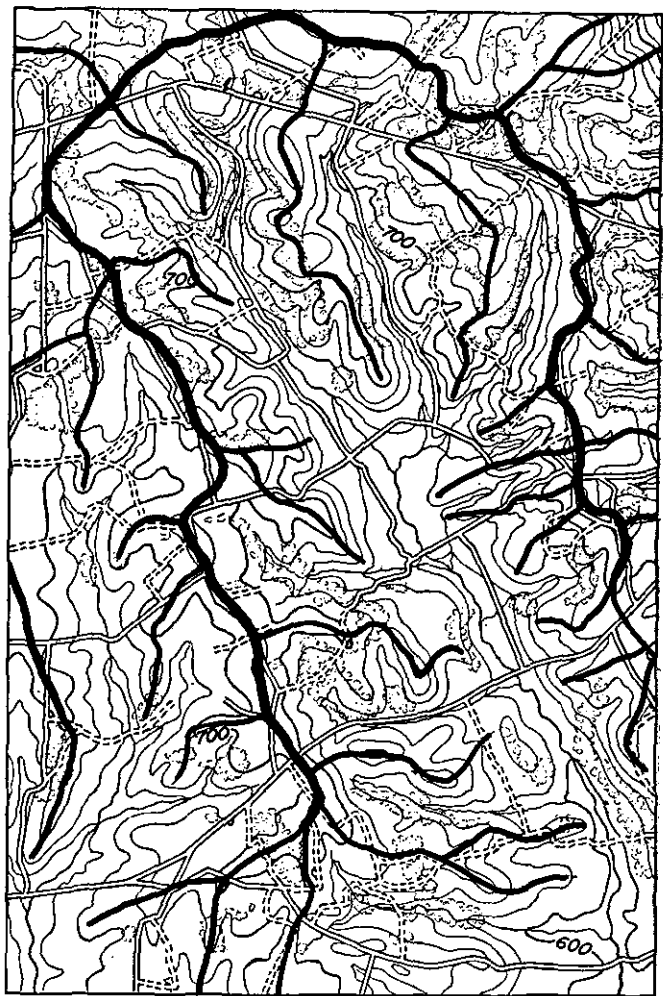

③ Ridge lines emphasized.

Figure 1—Continued.



④ Drainage and ridge lines emphasized.

Figure 1—Continued.



⑤ 600- and 700-foot contour lines emphasized.

Figure 1—Continued



⑥ Different elevations emphasized by shading.

Figure 1—Continued

emphasizes the ridge lines. Usually this is done in brown or red. Figure 1 ④ shows the drainage and ridge lines emphasized on the same map. The more pronounced ridge and drainage lines are given special emphasis by marking them more heavily.

(2) In figure 1 ⑤ the 600- and 700-foot contours are emphasized with a heavy line. In figure 1 ⑥ the ground having an elevation over 640 feet has been indicated by light shading; ground with elevation over 700 feet, by darker shading; and ground with elevation under 640 feet is unshaded. Elevations on a contoured map frequently are emphasized by using a separate tint or color for each range of elevation, to make ground forms and commanding elevations more apparent.

(3) Figure 2 ① shows a section of a photomap, and figure 2 ② shows the same map after the drainage lines have been emphasized. Usually, unless they are emphasized, it is quite difficult to follow the minor drainage lines on an aerial photograph or photomap. However, by stereoscopic examination of suitably overlapping aerial photographs, the minor drainage or ridge lines easily may be distinguished.

(4) Figure 3 ① shows a section of an uncountoured map. Although no contours are shown, a fairly accurate visual picture of the actual shape of the terrain may be had by interpolating ridge lines halfway between drainage lines, as shown in figure 3 ②. In general, main ridges divide principal drainage systems. Therefore, the approximate location of important ridge lines usually can be determined, even though actual elevations are not known.

b. Roads. Figure 3 ③ emphasizes roads. Roads of different classification or type can be indicated by different colors. For a division, a map of this nature is



① Section of photomap.

Figure 2.

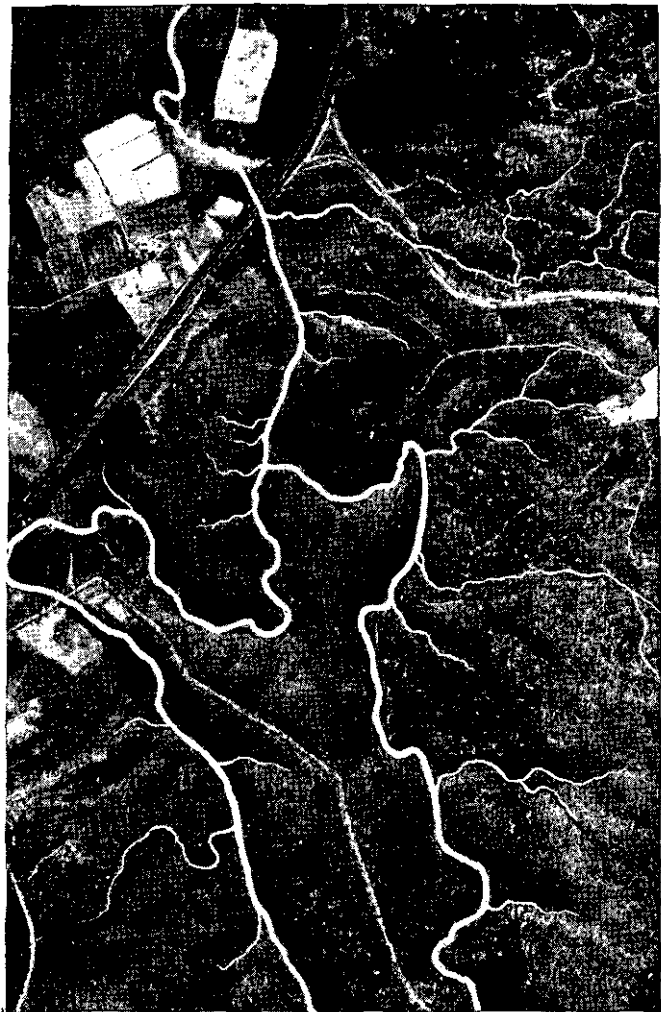

② Section of photomap with drainage lines emphasized.

Figure 2—Continued.

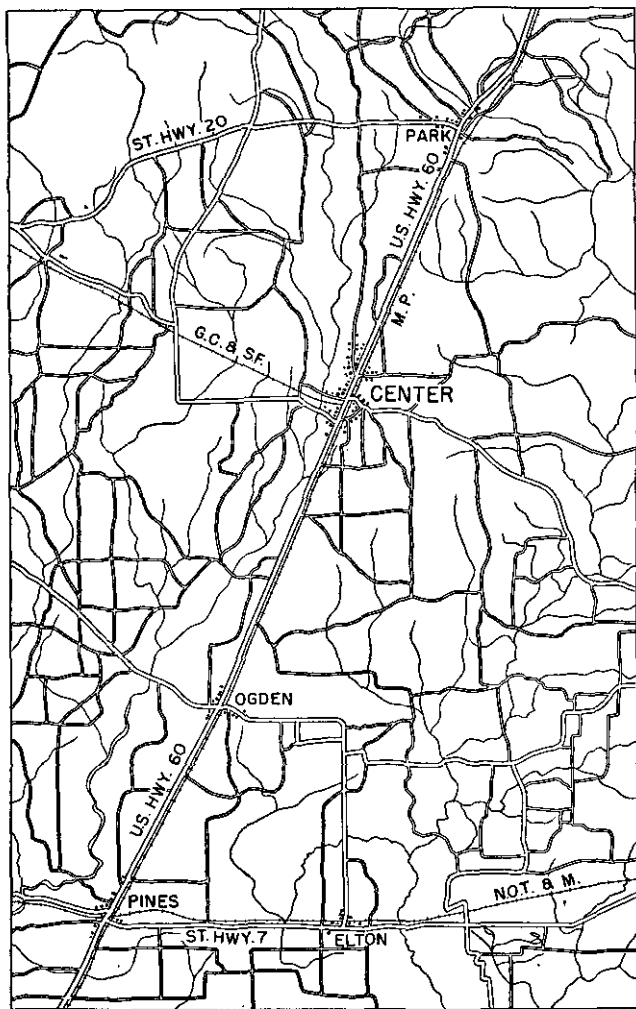

① Section of uncounted map.

Figure 3.

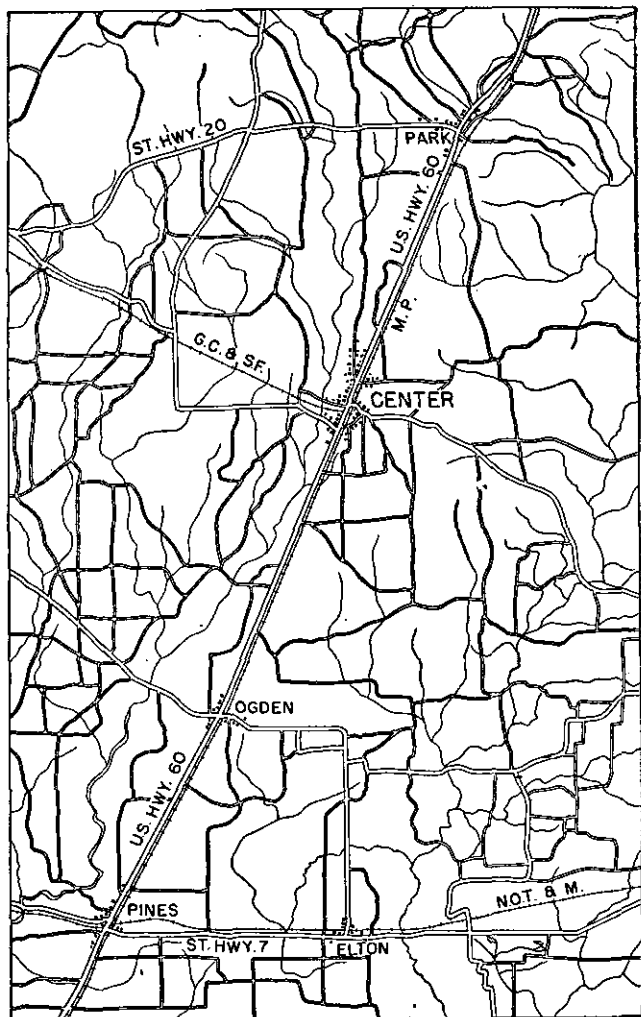

② Ridge lines interpolated between stream lines.

Figure 3—Continued.

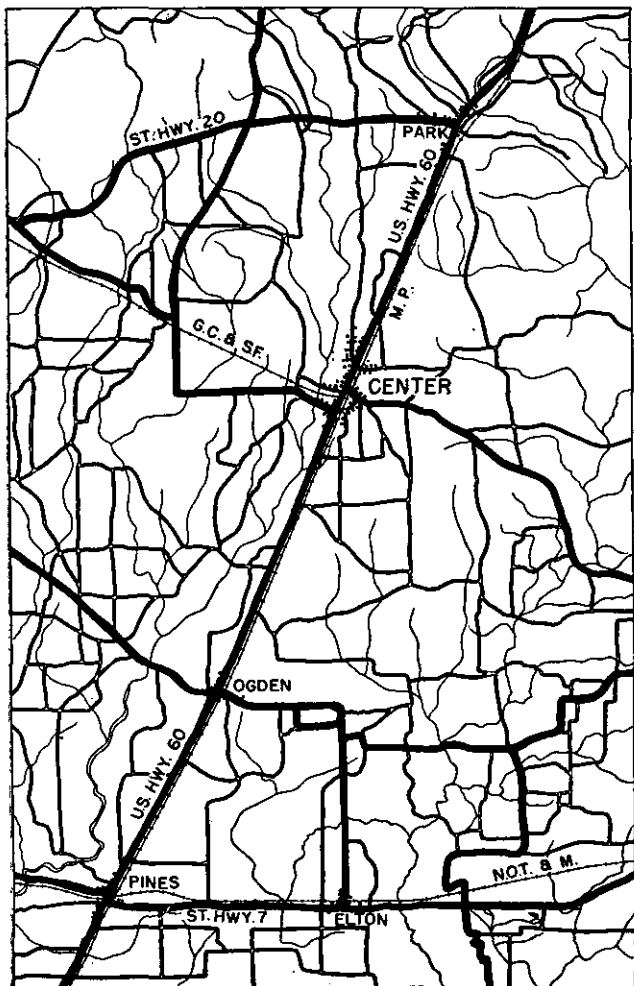

③ Important roads emphasized.

Figure 3—Continued.

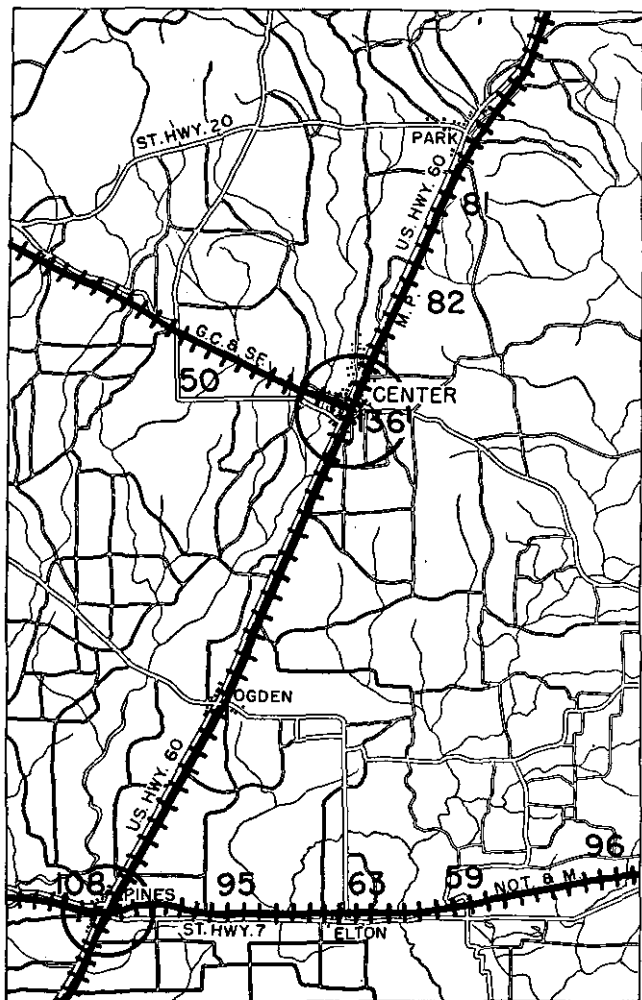

④ Railroads emphasized. Figures indicate siding capacities. Circles indicate railroad yards.

Figure 3—Continued.

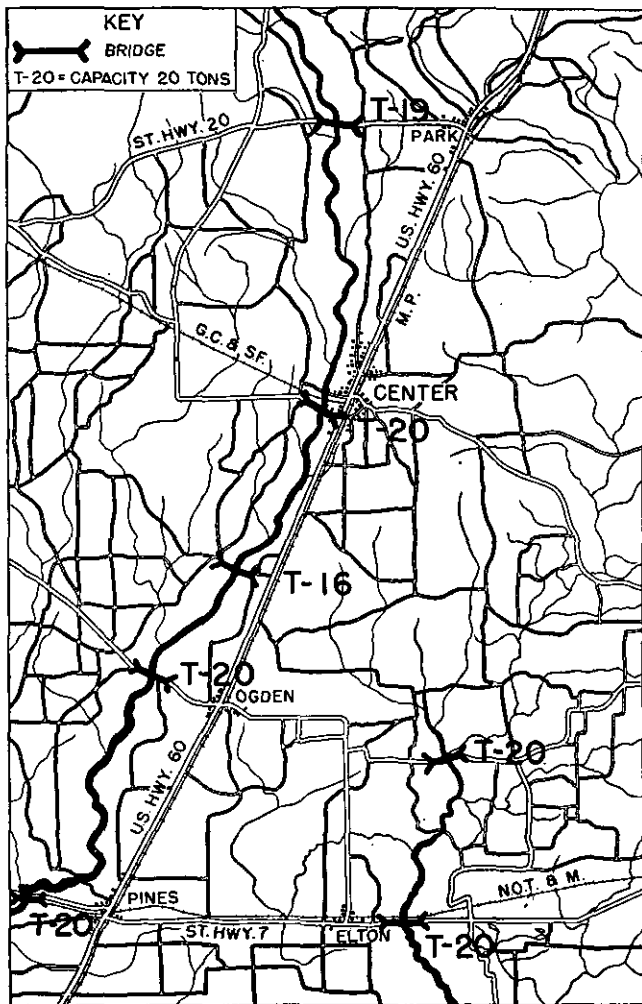

⑤ Bridges and rivers emphasized.

Figure 3—Continued.

often used to emphasize all roads which are able to carry the division loads.

c. Railroads. Figure 3④ emphasizes railroads. Numbers indicate siding capacities and circles indicate yards.

d. Bridges. Figure 3⑤ emphasizes rivers and bridges with their capacities.

e. Other features of military importance. Other features of military importance, such as natural resources and water resources, may be emphasized on special maps in a manner similar to that used for roads, railroads, and bridges.

SECTION III

TACTICAL STUDY OF TERRAIN

12. PURPOSE. Evaluation of the terrain is an important element in every tactical operation. Its tactical study may be mental, oral, or written, depending upon circumstances. It may be made by the commander himself, or by any subordinate designated by him.

13. LIMITING CONSIDERATIONS. The terrain studied should include all of the area involved in the contemplated operation. The details of the study are affected by other considerations. A commander making a tactical study of the terrain is limited by his mission and by his own and the enemy's capabilities. G-3, in preparing details of a tactical study of the terrain, is limited by the capabilities of his own force

and by the commander's decision or directive for the operation; G-2 usually is limited by the enemy's capabilities. The specialist, such as the tank commander, the artillery commander, the chemical officer, or the engineer, will find his study limited by the powers and limitations of his arm or service.

14. GENERAL TOPOGRAPHY. Any deductions made as to the tactical effects of the terrain must be based on a knowledge of the topographical features of the area under consideration. The following usually should be considered:

a. Drainage system. Streams and valleys are of particular importance because, together with the intervening ridges, they make up the general framework of the terrain.

b. Ridge system. This is the complement of the drainage system and should be approached in the same manner.

c. Routes of communication. The road net available for tactical maneuver or supply, the presence or absence of rail facilities, navigable waters, and airplane landing facilities, all come under this subhead.

d. General nature of the terrain. All the foregoing information is summarized briefly in a final paragraph.

15. MILITARY ASPECTS OF TERRAIN. The facts upon which further conclusions are based having been stated, the study now proceeds to the evaluation and interpretation of these from the military point of view. At this point the study resembles an intelligence study, an operations study, or both. As a means of systematization, the area is divided for purposes of discussion

into natural subareas; or, if there are no distinctive natural boundaries, into subareas delimited with regard to the tactical situation. Within each subarea, terrain elements affecting the military situation are considered; where applicable, each element is considered both from the enemy's viewpoint, and from our own.

16. CRITICAL TERRAIN FEATURES. As a result of the study just indicated it frequently becomes clear that a certain terrain feature, for example a dominant hill or ridge, or an obstacle to mechanized attack, will be critical in the contemplated operation, or that its possession by either the enemy or by our own forces will have a marked influence upon the operations of either side. If there is such a terrain feature, it should be discussed briefly at this point; if there is not, a statement to that effect should be made.

17. TACTICAL EFFECT OF TERRAIN. This portion of the study should summarize the effect of the terrain on the immediate tactical or administrative situation. Using a systematic approach, frequently it is desirable to discuss separately the effect of the terrain upon each enemy capability, and then to discuss in a similar manner its effect upon each line of action contemplated by our own troops.

CHAPTER 3

GENERAL FORTIFICATION TECHNIQUE

SECTION I

TOOLS AND MATERIALS

18. TOOLS. Tools normally used for hasty fortification work are carried by the infantry. These may be supplemented by additional tools obtained from en-

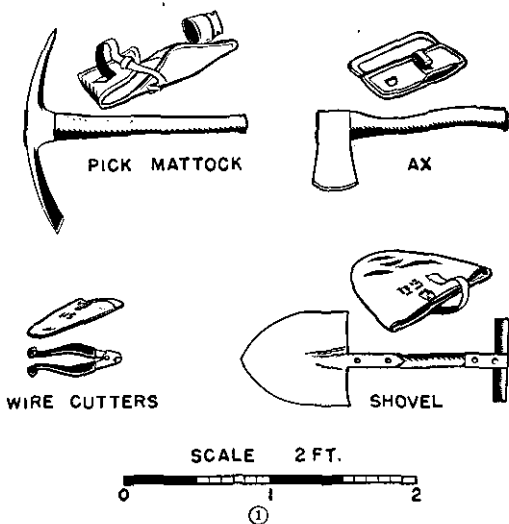
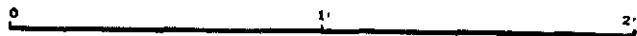
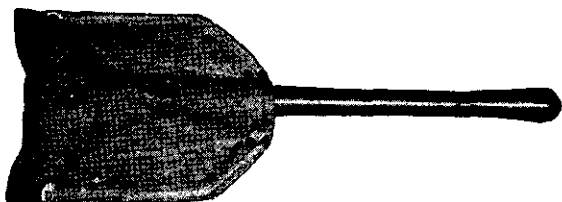

Figure 4. Entrenching tools carried by infantry soldiers.



SCALE



PACKED IN CARRYING CASE

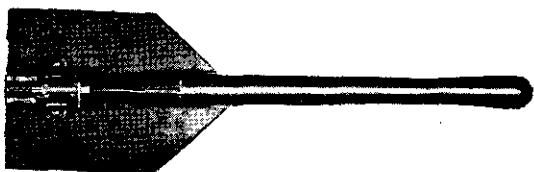

FOLDED FOR CARRYING

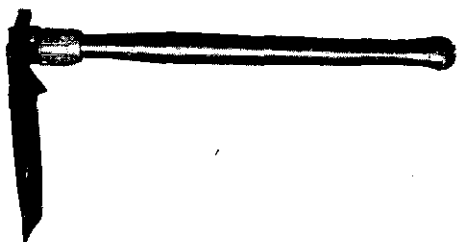

FOR USE AS A PICK

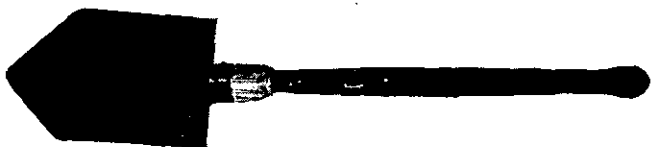

FOR USE AS A SHOVEL

(2)

Figure 4—Continued.

gineer supplies. Each infantry soldier carries a small entrenching tool (fig. 4) on his pack. Standard-sized tools are supplied in infantry entrenching tool sets (figs. 5).

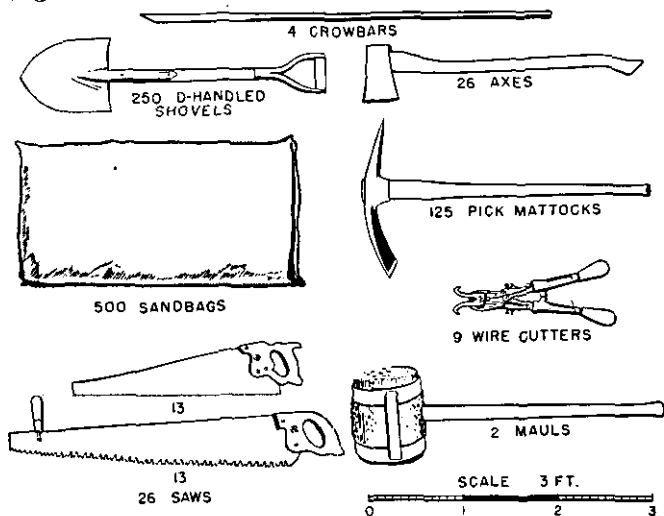

Figure 5. Principal tools carried in infantry entrenching tool set.

19. MATERIALS. Materials for fortification are supplied through engineer dumps, and include antipersonnel mines and firing devices, lumber, barbed wire and pickets, and materials for reveting, camouflage, shelter construction, and concrete construction. Antitank mines are supplied like ammunition.

SECTION II

GENERAL TECHNIQUE

20. CLEARING FIELDS OF FIRE. Suitable fields of fire are required in front of each entrenchment or

emplacement. In clearing them the following principles must be observed:

a. Do not disclose position by excessive or careless clearing (fig. 6).

b. In areas organized for close defense, start clearing near main line of resistance and work forward at least 100 yards.

c. In all cases leave a thin natural screen to hide defense positions (fig. 7).

d. In sparsely wooded areas, remove the lower branches of scattered, large trees. Occasionally it is desirable to remove entire trees which might be used as reference points for enemy fire.

e. In heavy woods, complete clearing of the field of fire is neither possible nor desirable. Restrict work to thinning undergrowth and removing lower branches of large trees. In addition, clear narrow lanes for fire of automatic weapons (fig. 8).

f. Remove or thin thick brush. It is never a suitable obstacle and obstructs the field of fire.

g. Demolish other obstructions to fire, such as buildings and walls, only when resulting debris provides less enemy protection.

h. Mow grain crops and hay fields or, if ripe and dry, burn them if it will not disclose the position. Usually this is practicable only for a deliberate position organized prior to contact with the enemy.

i. Drag away cut brush to points where it will not furnish concealment to the enemy nor disclose the position.

j. Before clearing the fields of fire make a careful estimate as to how much clearing can be done in the time available. This estimate often determines the nature and extent of the clearing to be undertaken, since

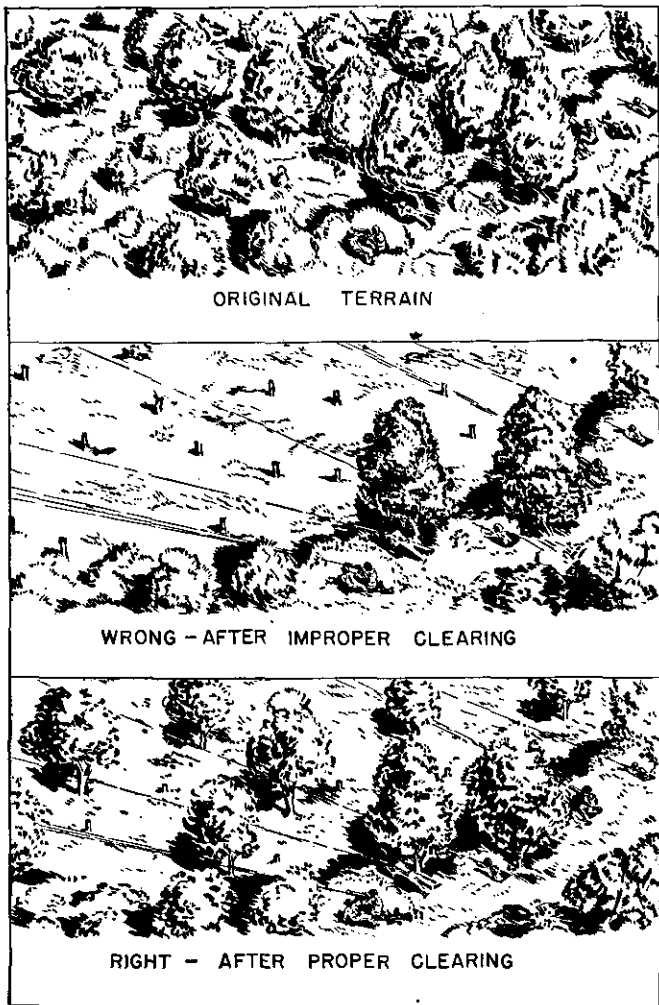
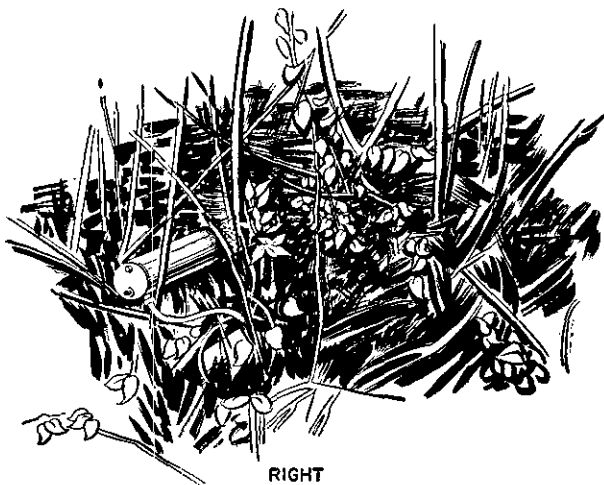

Figure 6. Clearing fields of fire.



WRONG
(IN FRONT OF NATURAL SCREEN)



RIGHT
(JUST BEHIND THIN NATURAL SCREEN)

Figure 7. Thin natural screen.



**WRONG~TOO MUCH CLEARING, DEBRIS
NOT REMOVED, ENEMY WILL AVOID.**

①

Figure 8. Clearing lanes of fire for automatic weapons.



RIGHT—ONLY UNDERBRUSH AND TREES DIRECTLY
IN LINE OF FIRE REMOVED, ENEMY SURPRISED.

⑧

Figure 8—Continued

a field of fire only partially cleared may afford the enemy better concealment and cover than the area in its natural state. Estimates may be based on table I, which makes no allowance for the removal of debris. Additional allowance must be made for this, depending upon the amount of debris, length of haul, and equipment available.

TABLE I. *Man-hours required to clear 100 square yards*

Description of clearing	Tools used	Man-hours required
Medium clearing—clearing undergrowth and some trees not exceeding 12 inches in diameter.	Saws, axes	3½
Light clearing—clearing small brush only.	Axes	1½

21. CAMOUFLAGE. Concealment is of prime importance in locating defensive works. Before any excavation is started, all turf, sod, leaves, or forest humus is removed carefully from both the area to be excavated and that on which spoil is to be piled. This material is set aside and replaced over the spoil when the work is completed. To prevent discovery of the work during excavation, camouflage nets are suspended from stakes or trees before excavation is started. The workers confine their activities to the area beneath the camouflage net. The net is suspended high enough above the ground to permit excavation without snagging equipment or entrenching tools on it. After the excavation has been completed and the spoil covered with sod or other natural camouflage material, the net is lowered close to the ground so that it is inconspicuous from ground observation. Nets are kept in position when the weapon is not being fired. Arrangements are made

to withdraw or lift the net during action. For a more complete discussion of camouflage, see FM 5-20.

22. EXCAVATION. Excavation is usually by pick and shovel. The nature of the soil, tools available, condition and experience of men, presence of the enemy, amount of light to work by, size of excavation, and weather conditions, all affect the rate of excavation. Because of the large number of variables involved, precise data cannot be given. As a rough guide, it may be stated that in medium soil, using standard size tools, a man in good condition can excavate between 20 and 30 cubic feet per hour. Table II gives estimates for excavation of man-hours required to build the various types of infantry weapons emplacements described in chapter 4.

TABLE II. *Excavation and camouflage data for infantry weapons emplacements*

Weapon	Type of emplacement*	Area to be camouflaged (feet)	Excavation (cubic feet)	Man-hours required to construct in medium soil
Rifle	Foxhole	10 x 10	37	1½
Automatic rifle	do	10 x 10	37	1½
Rocket launcher	Pit-foxhole	10 x 10	{ 125	1
	Pit	5 x 5	{ 287	4½
Machine gun, light, cal. .30.	Horseshoe	15 x 15	123	7
	2-foxhole	12 x 12	74	3
Machine gun, heavy, cal. .30.	Horseshoe	15 x 18	140	8
	3 foxhole	15 x 15	111	5
60-mm. mortar	Pit	14 x 14	70	4
81-mm. mortar	do	16 x 16	108	6
37-mm. AT gun	Circular	21 x 21	110	5
	Fan	29 x 29	195	10
	Rectangular	27 x 36	550	28
57-mm. AT gun	Fan	24 x 39	410	21
105-mm. howitzer M3	Circular	29 x 29	430	22

*See chapter 4 for details of emplacements. 1 Without foxholes. 2 With foxholes.

23. DISPOSAL OF SPOIL. Excavated soil is much lighter in color and tone than surface soil and must be hidden carefully lest its presence disclose the fortifica-



SPOIL BEING REMOVED CORRECTLY



SPOIL BEING CONCEALED CORRECTLY

Figure 9. Disposal of spoil.

tion (fig. 9). There are several ways to dispose of spoil.

a. It may be used to form a parapet if the topsoil is carefully saved and used to cover the parapet. Turf,

sod, leaves, or other litter from under nearby bushes or trees are used to make the parapet resemble its surroundings.

b. It may be removed and carefully hidden under trees or bushes or in ravines. Care must be taken to avoid revealing tracks.

c. It may be collected and used, partly camouflaged, to form parapets for dummy positions.

24. DRAINAGE. Lack of proper drainage increases the maintenance work and the hardships of the troops occupying the fortifications. It must be provided for in the lay-out and construction of all works.

a. **Proper location.** Proper location limits but does not eliminate the drainage problem. If possible, low points and drainage lines are avoided, and trenches are located on slopes (fig. 10). A slope of 1 percent causes all water to run to the lowest part of trench, from which it can be easily drained. Slopes exceeding $2\frac{1}{2}$ percent cause erosion.

b. **Surface and rain water.** Surface and rain water can be largely excluded by deflecting it through the use of small ridges (fig. 10) into ditches passed around the fortification, or over it by means of flumes.

c. **Subsurface water.** Surface water may be removed by the use of sumps or of drainage ditches (fig. 10) run to natural drainage lines from low points in entrenchments or emplacements. Sumps are located at low points and emptied by bailing, siphoning, or pumping. They should be a minimum of $1\frac{1}{2}$ feet square and 1 foot deep.

25. REVETMENTS. A revetment is a retaining wall, or facing, for maintaining an earth slope at an

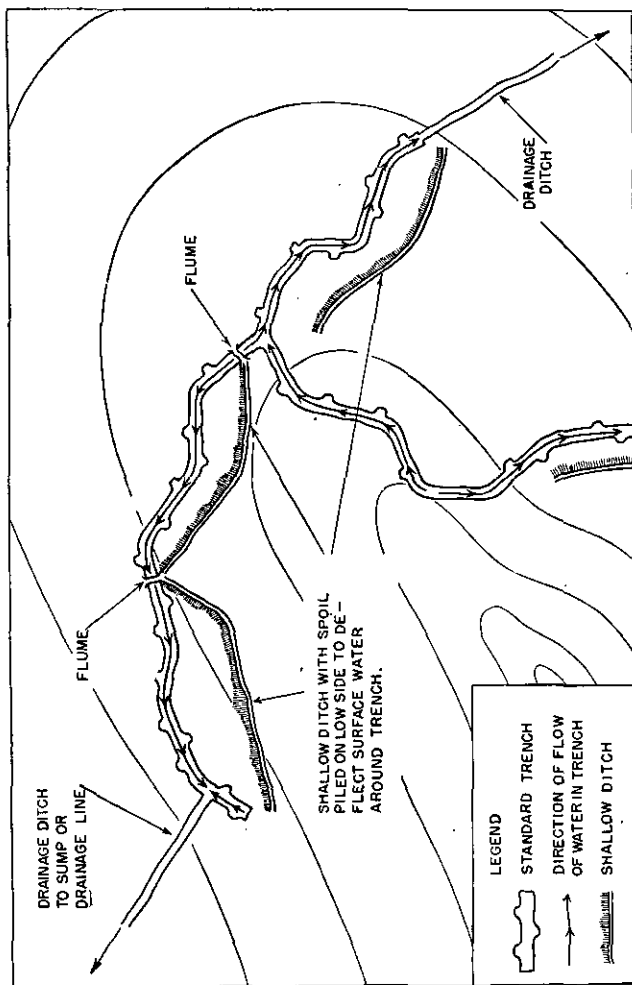

Figure 10. Trench properly located for drainage.

angle steeper than its natural angle of repose. In all but the hardest ground, when the position is to be occupied for more than a few days, some measures must be taken to prevent crumbling of walls. Decreasing the slope for this purpose also decreases protection afforded by the emplacement and makes concealment more difficult. Revetments require considerable labor and material, but reduce maintenance and insure stability. Earth walls in entrenchments and emplacements not only are subject to normal erosion processes and wear and tear of constant occupation, but also must withstand heavy earth shock caused by explosion of bombs and artillery shells. There are two kinds of revetment, the retaining-wall type and the surface or facing type.

a. Retaining-wall type. This type is self-supporting and acts by its weight. Dimensions of the excavation must be increased to allow space for this type of revetment.

(1) Sandbag revetment. These are particularly useful for emergency work, for repairs, and on the interior slopes of earth parapets.

(a) The standard sandbag measures 14 by 26½ inches when empty, and has a string attached 3 inches from the top. When three-fourths full, the bag weighs from 40 to 75 pounds, depending upon nature and moisture content of the filler. The average filled sandbag weighs about 65 pounds, and occupies a space 4¾ by 10 by 19 inches. The following data are useful in estimating the number of sandbags required for reveting purposes:

1. If a single row of stretchers is used, as occasionally is done for small revetments, about 160 sandbags are required for each 100 square feet of surface to be reveted.

2. If alternate headers and stretchers are used, as is proper, about 320 sandbags are required for each 100 square feet of surface to be reveted.

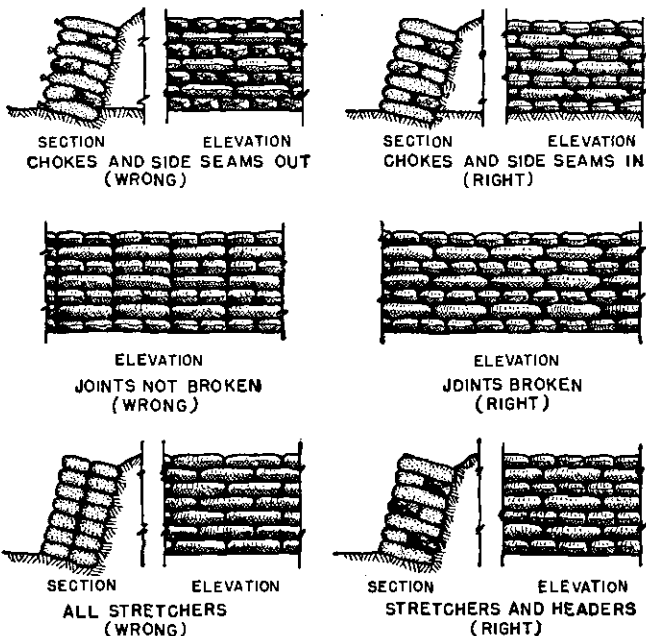

Figure 11. Sandbag revetment.

3. If sandbags are used for fills, parapets, or breastworks, about 195 are required for each 100 cubic feet of fill.

(b) Ordinary sandbags should be used for temporary revetting only. Where bags are to be in place for a month or longer under average conditions of moisture, they must be rotproofed or filled with soil partially

stabilized with cement or bitumen. The latter method usually is simpler in the field.

(c) Sandbags are laid as follows (fig. 11):

1. Fill bags uniformly about three-fourths full.
2. Tuck in bottom corners of bag after filling.
3. Build walls with slope 3 on 1 to 4 on 1.
4. Place bags perpendicular to slope.
5. Place bottom row headers.
6. Alternate intermediate rows as headers and stretchers.
7. Complete with a top row of headers.
8. Place side seams and choked ends on the inside.
9. Break joints and beat bags into place and into rectangular shape with back of shovel, or tamp with feet.

(2) **Sod revetment.** Thick sod makes durable revetments. Sods are cut about 18 by 9 inches, laid grass down, except for top layer, and pinned together with wooden pegs. The procedure given for sandbag revetment applies.

b. Surface or facing revetment. Surface or facing revetment must be supported, and serves mainly to protect the reveted surface from effects of weather and damage due to occupation. When strongly constructed, it retains loose material. Its top should be about 8 inches below the ground level to prevent its being snapped or damaged if tanks cross the reveted wall.

(1) **Issue material.** Issue material, such as burlap and chicken wire, wire mesh, expanded metal (XPM), or corrugated iron, for this type of revetment may be obtained in limited quantities at engineer dumps. These materials are held in place against the surface to be reveted either by wooden pickets (at least 3 inches in diameter) or by issue steel pickets. Pickets

are driven into the floor and held at the top by holdfasts. In installing this type of reveting (fig. 12), the following operations are necessary:

(a) Cut grooves for pickets into wall to be reveted. Space $1\frac{1}{2}$ to 6 feet apart, depending upon reveting material to be used.

(b) Prepare holdfast in front of each groove. Hold fast anchor picket should be from 8 to 10 feet from wall.



Figure 12. Installing burlap and chicken-wire revetment.

(c) Place two end pickets loosely. Stretch material between them and hold taut while end pickets are tightened.

(d) Drive all pickets at least $1\frac{1}{2}$ feet into floor and fasten tops to anchor pickets with two turns of No. 10 wire. Draw pickets tight by racking. Pickets draw material tight against surface to be reveted.

(2) **Natural material.** Since issue material often is difficult to obtain in the field, most reveting is done

with natural material such as brush and cut timber obtained at the site.

(a) A *brushwood hurdle* (fig. 13) is a woven revetment unit usually 6 feet long and of required height. Brushwood less than 1 inch in diameter at butt is woven on a framework of sharpened pickets driven into the ground at 18-inch intervals. When finished, hurdle is

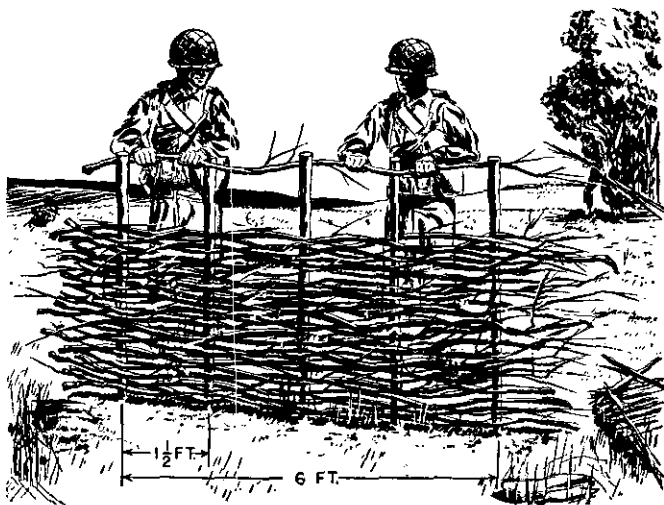

Figure 13. Building a brushwood hurdle.

removed and carried to erection site where pickets are driven into floor and held in place by holdfasts.

(b) *Continuous brush revetment* (fig. 14) is constructed by driving 3-inch pickets at 1-pace intervals about 4 inches from face of surface to be reveted. Space behind the pickets then is packed with small, straight brush laid horizontally. Pickets are drawn tight by means of holdfasts.

(c) *Cut-timber revetment* (fig. 15) is the principal



Figure 14. Continuous brush revetment.

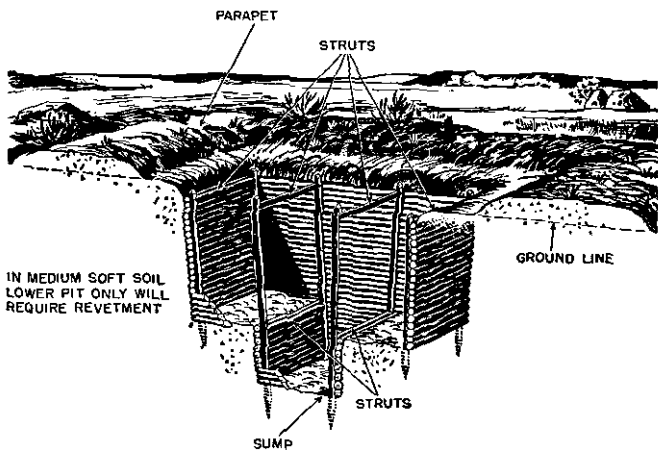
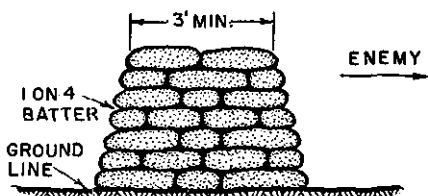
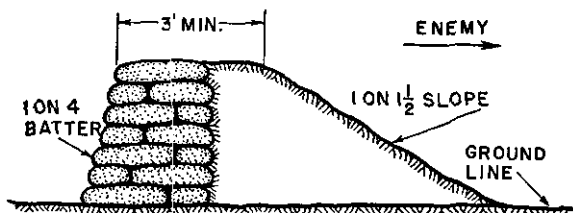

Figure 15. Cut-timber revetment.

natural means of reveting foxholes and emplacements. It is similar to continuous brush revetment, except that a horizontal layer of small timbers, cut to length of wall to be reveted, is used in place of brush. Pickets



① SANDBAG BREASTWORK



② SANDBAG AND EARTH BREASTWORK

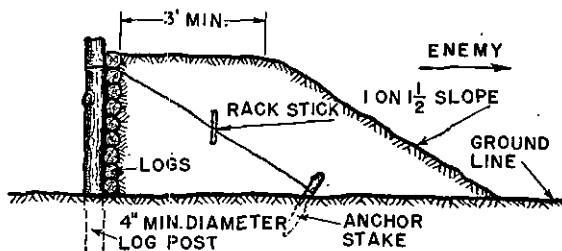

③ LOG FENCE AND EARTH BREASTWORK

Figure 16. Breastworks (height varies).

are held in place by holdfasts or struts. When available, dimension lumber may be used in a similar manner.

26. BREASTWORKS AND PARAPETS. Breastworks and parapets are built for protection when soil conditions or subsurface water prevent excavation. They also are used with dug-in emplacements to save extra digging. They are built at least 3 feet thick at the top to protect against caliber .30 bullets and against shell fragments. Also, they should be free of loose rocks and pieces of wood. Figure 16 illustrates various types of breastworks.

27. PROTECTION AGAINST TANKS. So far as practicable, entrenchments and emplacements are built to provide protection against tanks. Rocks or other pieces of hard material should not be left on or near the surface of the ground within 3 or 4 feet of the lip of the entrenchment or emplacement. The pressure on such a rock caused by a tank collapses earth walls which otherwise would be able to withstand the passage.

CHAPTER 4

ENTRENCHMENTS AND EMPLACEMENTS

SECTION I

GENERAL

28. EMPLOYMENT. a. It must become a habit of all soldiers to seek protection from enemy fire, advantage being taken of natural cover such as ditches or holes in the ground. Whenever the situation becomes stabilized temporarily, they dig entrenchments for themselves and emplacements for their weapons. This applies to crews of all weapons; personnel guarding road blocks, bridges, rear installations, and tactical headquarters; and troops in bivouac or assembly areas.

b. In all defensive situations troops are trained to strengthen their positions and seek protection by the immediate construction of hasty field fortifications.

c. In the attack troops are trained to drive forward until the objective is captured and consolidated, taking full advantage of all existing cover. Positive measures are taken to insure that the momentum of attack is maintained. A change from the offensive to the defensive is a responsibility of command and is justified only when necessary to avoid ruinous losses.

29. REQUIREMENTS. Entrenchments and emplacements must meet the following requirements:

- a. Permit each individual or weapon crew to accomplish the assigned fire mission.
- b. Be simple and easily constructed.
- c. Provide maximum protection with minimum time and labor.
- d. Provide all-around defense.
- e. Afford maximum concealment.
- f. Provide protection against mechanized attack.

SECTION II

INFANTRY ENTRENCHMENTS FOR HASTY FORTIFICATIONS

30. GENERAL. Entrenchments are located to cover a selected area with fire and, at the same time, provide concealment from aerial and ground observation and protection from enemy fire. These requirements are met when the troops are located in one- or two-man foxholes as described in this manual. To confuse the enemy, judicious use must be made of decoys or dummy positions.

31. FOXHOLES. a. General. Foxholes are entrenchments normally dug for individual protection when contact with the enemy is imminent or in progress. They provide excellent protection against small-arms fire, artillery shell fragments, airplane fire or bombing, and the crushing action of tanks. The one- and two-man foxholes are basic types, the choice of type resting with

the squad leader if not prescribed by higher authority. The two-man foxhole is used when men must work in pairs or when, for psychological reasons, battlefield comradeship is desirable.

b. Use. For units within the battle position, foxholes are sited with the longer side generally parallel to the front, but they are distributed around weapon emplacements to provide for all-around defense. Troops occupy their foxholes only when an attack is imminent or in progress. In some situations, where the need for rest is paramount, commanders may permit soldiers to stop excavation before full depth has been reached.

32. ONE-MAN FOXHOLE (fig. 17). a. Dimensions.

(1) The size and shape of the foxhole are affected by the following:

(a) It is as small as practicable, to present the minimum target to enemy fire.

(b) It is wide enough to accommodate the shoulders of a man sitting on the firestep.

(c) It is long enough to permit the use of large-size entrenching tools.

(d) It is at least 4 feet deep to the firestep, from which the standing occupant should be able to fire.

(e) A sump is dug in one end for bailing out water and for the feet of the seated occupant.

(2) The foregoing considerations result in the dimensions shown in figure 17. The soldier should memorize these simple dimensions: 2 feet wide, 3½ feet long, 4 to 5 feet deep depending upon the height of the man, and additional depth at one end for the sump.

b. Details of construction. In most types of soil the foxhole gives positive protection against the crushing action of tanks, provided the soldier crouches at least

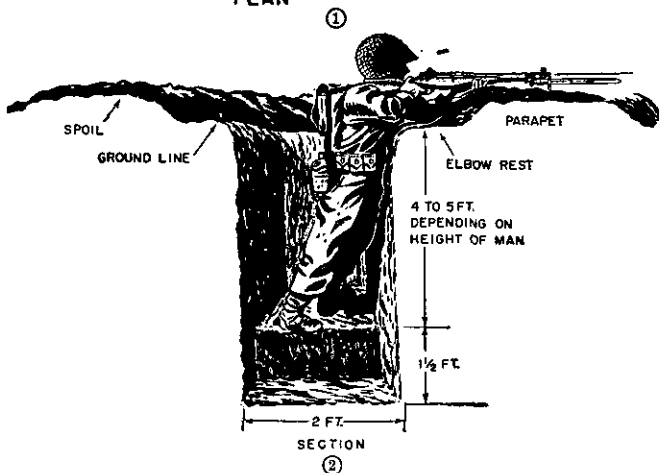
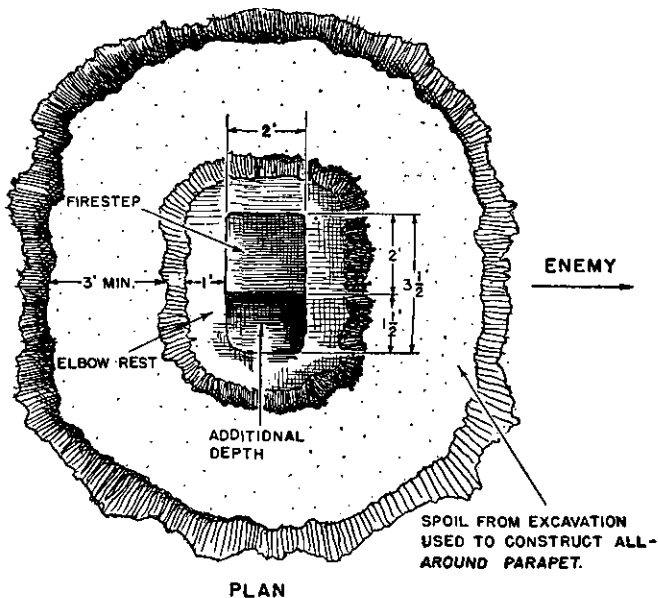

Figure 17. One-man foxhole. (Camouflage omitted.)

2 feet below the ground surface (fig. 18). In very sandy or very soft soils it may be necessary torevet the sides to prevent caving in. The spoil is piled around the hole as a parapet, 3 feet thick and approximately $\frac{1}{2}$ foot

MINIMUM 2 FEET CLEARANCE
REQUIRED TO PROTECT AGAINST
TANK TRACKS

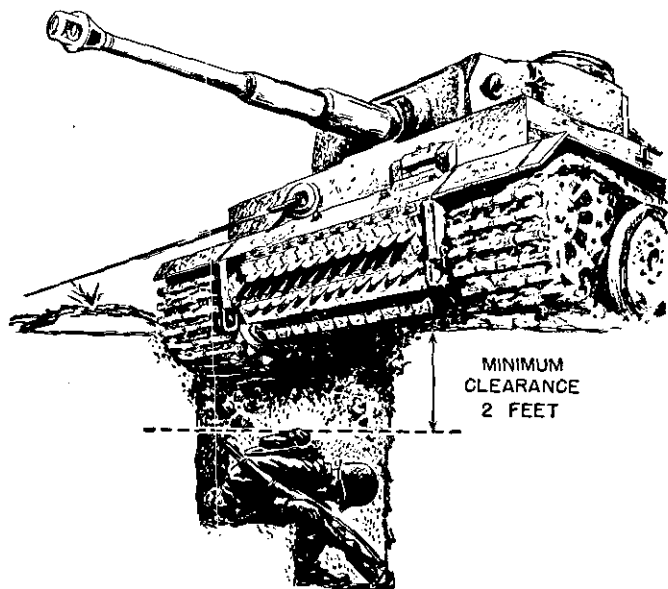
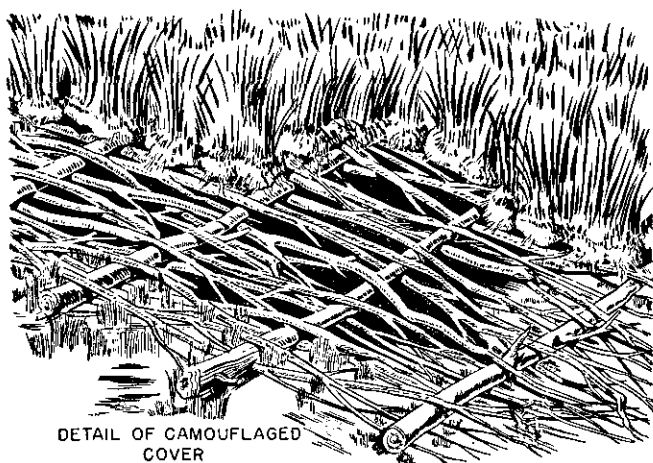

Figure 18. One-man foxhole protects against tanks.

high, leaving a berm or shelf wide enough for the soldier to rest his elbows upon while firing. If turf or topsoil is to be used to camouflage this parapet, the soldier first removes the topsoil from an area 10 feet square and sets it aside until the foxhole is completed.

c. **Foxhole with camouflage cover.** It may be practicable for the soldier to remove the spoil to an inconspicuous place and to improvise a camouflage cover for his foxhole (fig. 19). This technique is especially effective against a mechanized attack supported by foot soldiers. Riflemen remain concealed until the tanks have overrun the position; then they rise up and combat the enemy foot soldiers following the tanks.



①

Figure 19. One-man foxhole with camouflaged cover.

33. TWO-MAN FOXHOLE (fig. 20). The two-man foxhole consists essentially of two adjacent one-man foxholes. Since it is longer than the one-man type, the two-man foxhole offers somewhat less protection against tanks crossing along the long axis, as well as against airplane strafing and bombing and artillery shell fragments. Figure 15 shows a two-man foxhole revetted in soft or sandy soil.

34. INDIVIDUAL PRONE SHELTER. Prone shelters (fig. 21) seldom are dug in forward areas. They may be authorized in rear areas when ground attack is unlikely, or when the warning service insures sufficient time to construct foxholes. The prone shelter, being shallow, *does not* provide protection against the crush-

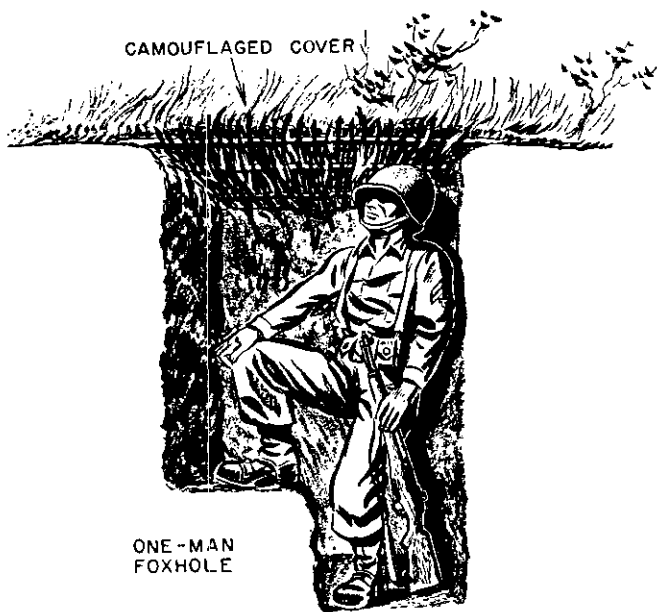

⊕ Figure 19—Continued.

ing action of tanks and is *not* suitable as a firing position. The prone shelter gives considerable protection against hostile artillery and aviation and against small-arms fire.

35. CONNECTING TRENCHES. Connecting trenches (fig. 22) are conspicuous to aerial observers and on

aerial photographs, and thus reveal the defensive dispositions. Continuous connecting trenches are not dug as a normal procedure. When two forces are in contact and dispositions have been revealed beyond any ques-

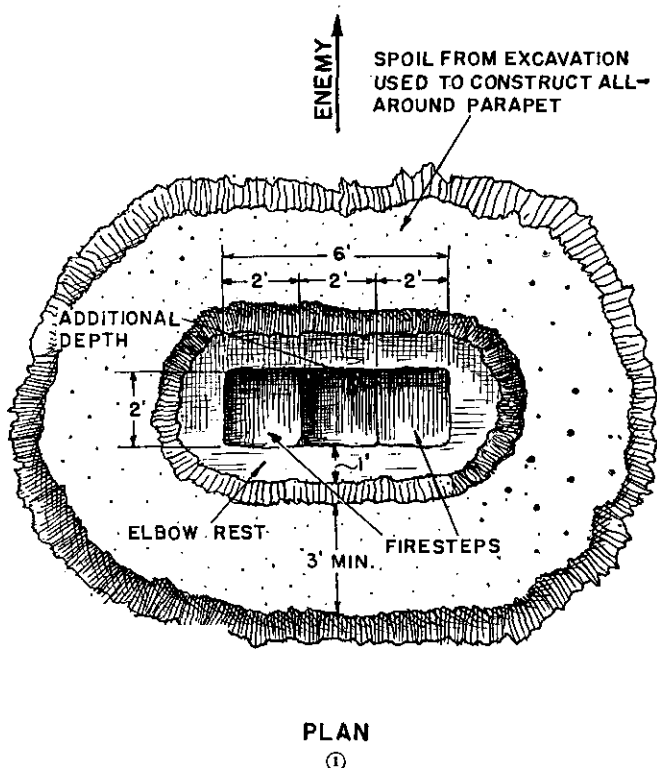
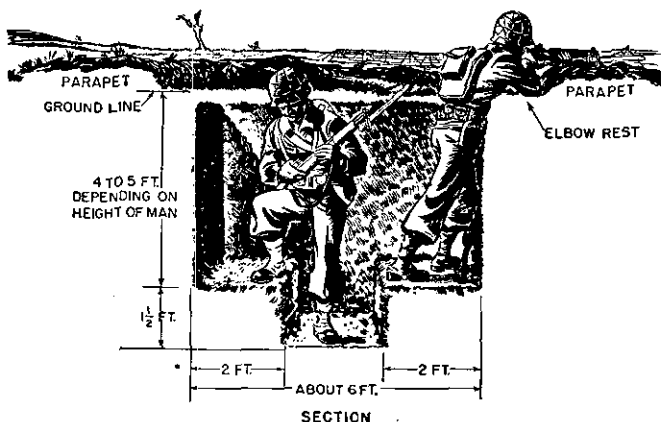

Figure 20. Two-man foxhole. (Camouflage omitted.)

tion, a few short trenches may be dug in inconspicuous places to permit necessary daylight movement across exposed areas. Necessary connecting trenches also may be dug in close country, such as jungle, where the posi-

tion probably will not be disclosed. Further, they may be dug whenever the improved protection, control, communications, and supply outweigh the sacrifice of concealment.

36. OBSERVATION POSTS. When observers are located in exposed positions, they should be well protected and concealed.



② Figure 20—Continued.

a. Both the one-man foxhole (fig. 17) and the two-man foxhole (fig. 20) with camouflaged cover (fig. 19) are suitable for use as observation posts.

b. The covered observation post (fig. 23), although a good type, takes considerable time to build. Since the overhead cover provides splinterproof protection only, this type of observation post is valuable only when well concealed. It requires 21 cubic feet of excavation per foot of length, or a total of 105 cubic feet per 5-foot section.

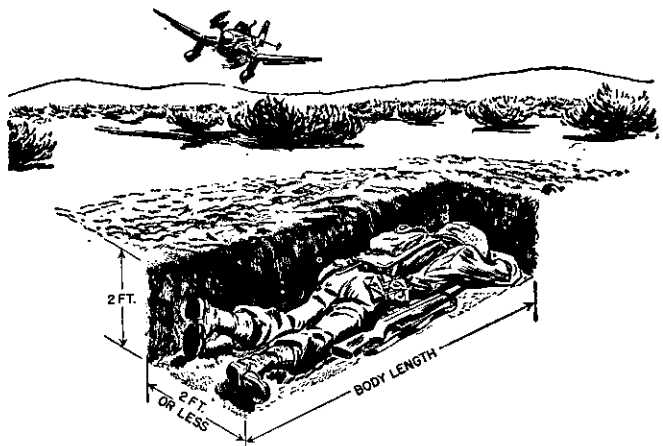

Figure 21. Prone shelter (not a fire trench).

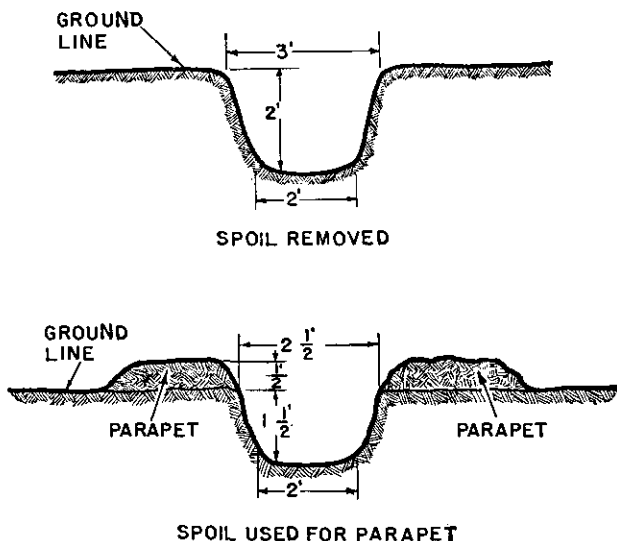

Figure 22. Shallow connecting trench. (Camouflage omitted.)

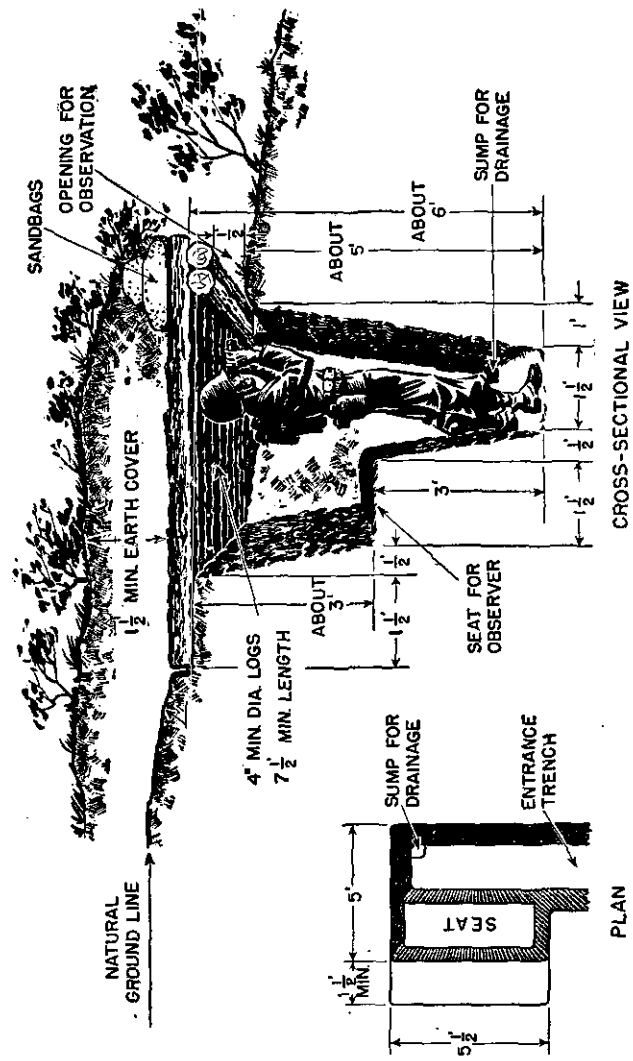

Figure 23. Covered observation post.

SECTION III

INFANTRY WEAPON EMPLACEMENTS

37. GENERAL. Because of their advanced positions, infantry weapons such as machine guns, antitank guns, mortars, and cannon generally require emplacements for the protection of weapons and crews, and foxholes to protect personnel not sheltered in the emplacement. Careful attention is paid to camouflaging emplacements against both ground and aerial observation. Dummy emplacements are constructed for deception. (See table II for an estimate of the man-hours required to dig the emplacements described in this section.)

38. AUTOMATIC RIFLE. The automatic rifle is fired from a one-man foxhole and does not require special emplacement.

39. CALIBER .30 MACHINE GUN (LIGHT). There are two types of emplacements for this gun: the horseshoe type and the two-foxhole type.

a. Horseshoe type (fig. 25). (1) The gun is placed in firing position ready for immediate action. Lying down, if exposed to fire, the crew first excavate about $\frac{1}{2}$ foot beneath the gun and then a similar depth for themselves, thus making an open shallow pit (fig. 24). The spoil is piled around in a parapet.

(2) The emplacement is completed by digging out a horseshoe-shaped trench, about 2 feet wide, along the rear and sides of the pit, leaving a chest-high shelf to the center and front to serve as a gun platform (fig. 25).

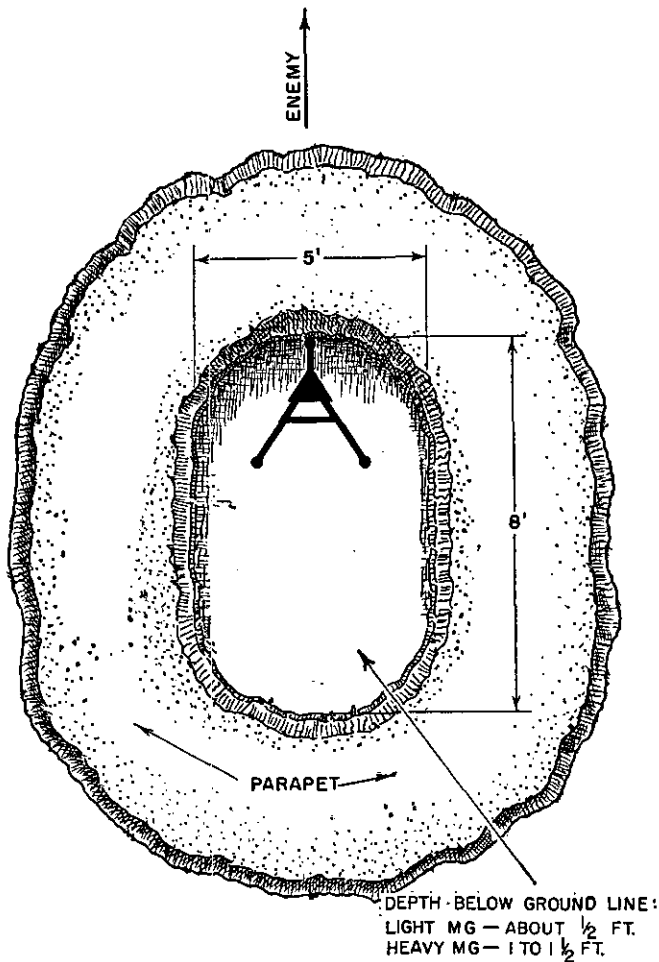

Figure 24. Initial stage in horseshoe type emplacement for caliber .30 machine gun (light or heavy). (Camouflage omitted.)

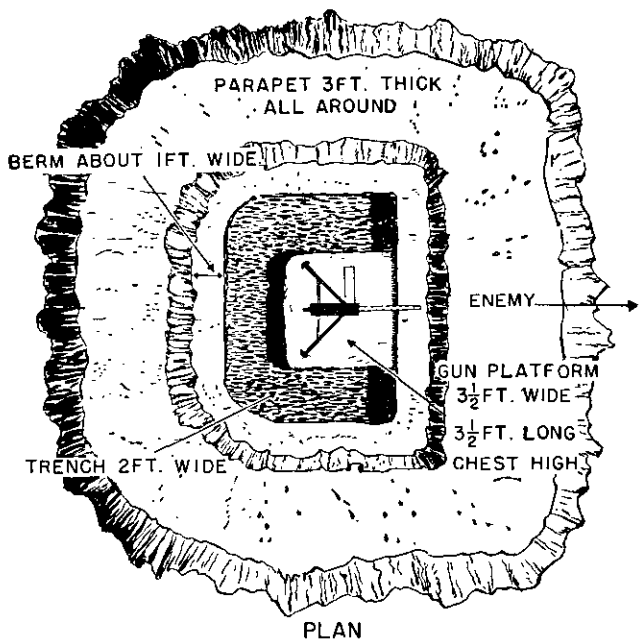

Figure 25. Horseshoe type emplacement for caliber .30 machine gun (light). (Camouflage omitted.)

The spoil is piled around the emplacement to form a parapet at least 3 feet thick and low enough to permit all-around fire.

(3) This emplacement furnishes protection against small-arms fire and shell or bomb fragments. In firm soil, this emplacement offers protection against the crushing action of tanks. In loose soil, logs about 8 inches in diameter, placed across front, rear, and sides of the emplacement and embedded flush with the top of the ground, help to make the emplacement resistant to the crushing action of tanks. When tanks appear about to overrun the position, the gunners pull the weapon to the bottom of the trench at the rear of the emplacement and then crouch down to either side.

b. Two-foxhole type (fig. 26). This emplacement consists of two one-man foxholes close to the gun position. To lay it out, a short mark is scratched on the ground in the principal direction of fire. On the right of this mark a foxhole is dug for the gunner. On the left of the mark and 2 feet to the front, another foxhole is dug for the assistant gunner. The spoil is piled all around the position to form a parapet, care being taken to pile it so as to permit all-around fire of the weapon. In firm soil, the two-foxhole type provides protection for the crew and the weapon against the crushing action of tanks. When tanks appear about to overrun the position, the gun is removed from the tripod and taken into one foxhole, the tripod into the other. The gunner and assistant gunner crouch in the holes.

c. Choice of type. As a firing position, the two-foxhole type is a little less flexible than the horseshoe type, but it is easier to construct and more nearly tank-proof than the horseshoe type. Therefore, the two-foxhole type generally is preferred.

40. CALIBER .30 MACHINE GUN (HEAVY). There are two types of combat emplacements for this gun: the horseshoe type and the three-foxhole type. In addition,

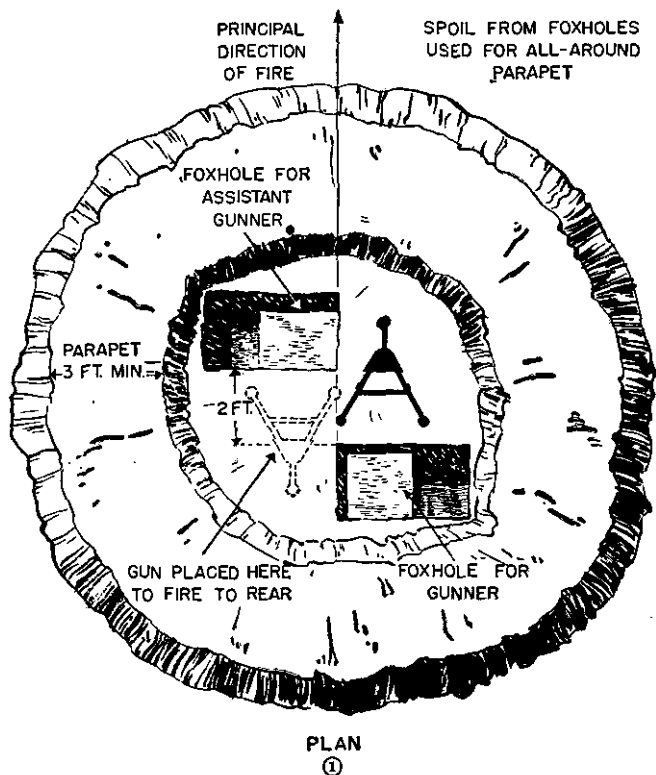
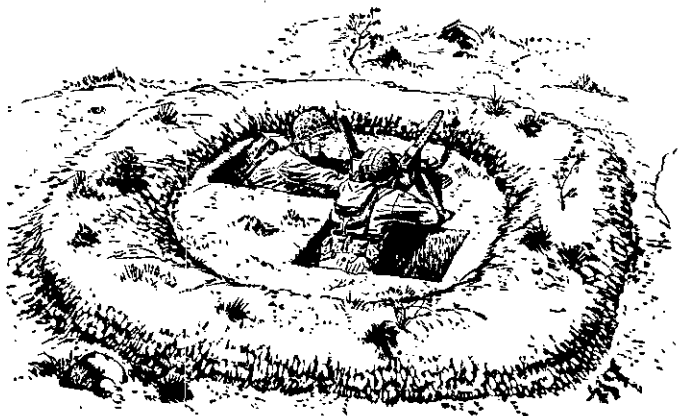

Figure 26. Two-foxhole type emplacement for caliber .30 machine gun (light). (Camouflage omitted.)

there is an anti-aircraft type for use when the gun is mounted on elevator for fire against air targets.

a. Horseshoe type (fig. 27). This emplacement is similar to the one described for the light gun (par. 39).

The open shallow pit for the heavy gun (fig. 24) is dug somewhat deeper, from 1 to 1½ feet below ground level. Construction procedure is the same. This emplacement permits easy traverse of the gun through 180°. To fire aimed shots to the rear, the gunner must get out of the trench and sit on the forward part of the gun platform. In most types of soil, tanks can run over this emplacement without destroying it, the



②

Figure 26—Continued.

weapon, or the occupants. In loose soil, logs about 8 inches in diameter placed across the front, rear, and sides of the emplacement and embedded flush with the top of the ground help to make it tankproof. Upon the approach of tanks, the crew, without dismounting the weapon from the tripod, move it to the rear into the horseshoe trench and then crouch down to either side.

b. Three-foxhole type (fig. 28). The tripod legs for the heavy machine gun are reversed when the

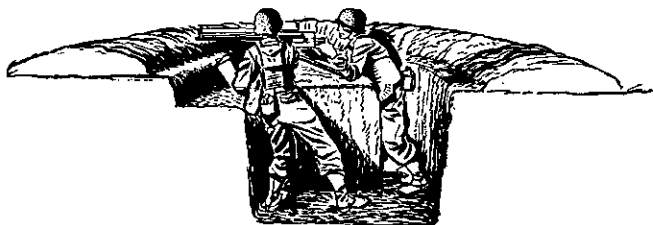
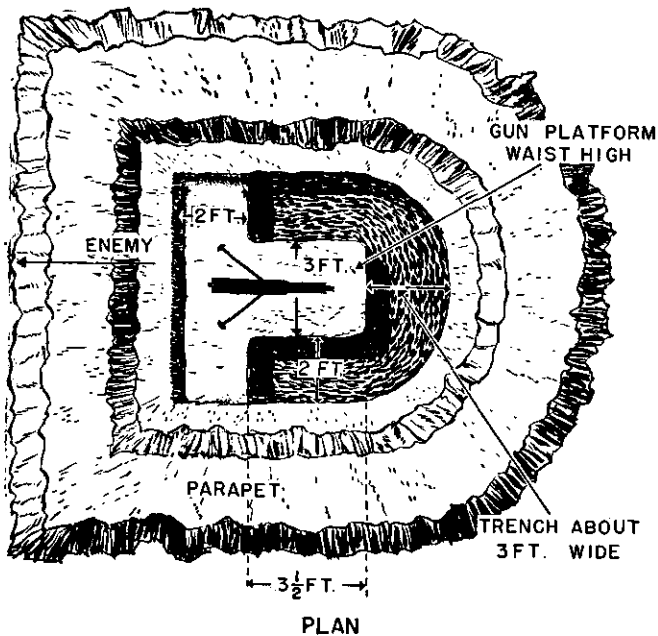

SECTION

Figure 27. Horseshoe-type emplacement for caliber .30 machine gun (heavy). Camouflage omitted.

weapon is fired from the three-foxhole emplacement. This allows the gun to be mounted close to the gunner's foxhole, which is immediately behind the weapon. The assistant gunner occupies the foxhole to the left. The third foxhole remains unoccupied until it becomes necessary to fire the gun to the left, at which time the

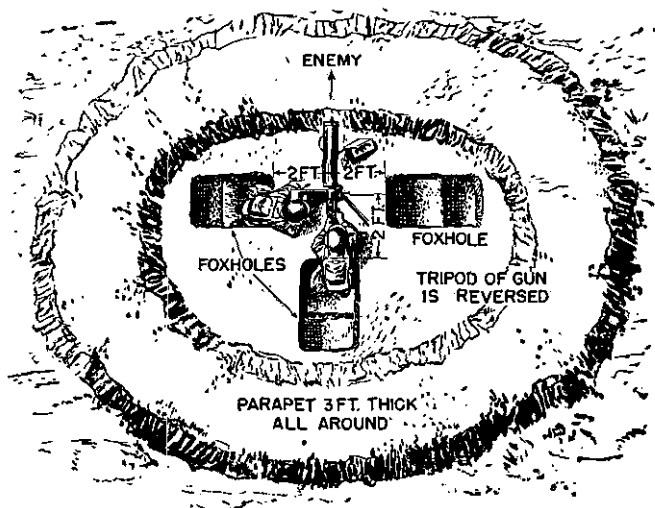

Figure 28. Three-foxhole type emplacement for caliber .30 machine gun (heavy). Camouflage omitted.

gunner and the assistant gunner shift to the right (counterclockwise). The spoil is piled all around the emplacement to form a parapet, care being taken to pile it so as to permit all-around fire of the weapon. When tanks appear about to overrun the position, the gun is dismounted from the tripod and the tripod is collapsed. One member of the crew takes the gun with him into his foxhole; the other takes the tripod.

c. Comparison of combat types. In general, the horseshoe type and the three-foxhole type of emplacement are both satisfactory. As a firing position, the three-foxhole type is less flexible than the horseshoe type, but in some soils it may be more tankproof. The three-foxhole type has the advantage of using standard foxholes. However, the horseshoe type permits the gun to be restored more quickly to its firing position following a tank attack, since the gun remains on the tripod. For the latter reason, the horseshoe type generally is preferred for the heavy machine-gun.

d. Antiaircraft type (fig. 29). The caliber .30 heavy machine gun, provided with elevator, is emplaced in a circular pit about 4 feet in diameter at the bottom, deep enough to provide protection and yet allow the gun to engage ground targets. It is used only where defense against air targets is the primary consideration, as it does not provide the protection afforded by the horseshoe and three-foxhole types.

41. 60-MM MORTAR EMPLACEMENT (fig. 30). **a.**

Open type. This consists of a rectangular pit large enough to accommodate the mortar, the gunner, and the assistant gunner. The emplacement is kept to the minimum size to afford protection against airplane fire and bombing and against artillery shells, but it allows room for firing the mortar and storing necessary ammunition. The front edge is sloped so that the aiming stake, about 10 yards to the front, is visible through the sight and so the weapon's fire will be clear. The spoil from the excavation is piled all around the pit to form a low parapet. Foxholes for members of the mortar squad not required at the gun are prepared not far from the emplacement. Additional ammunition is placed in nearby shelters.

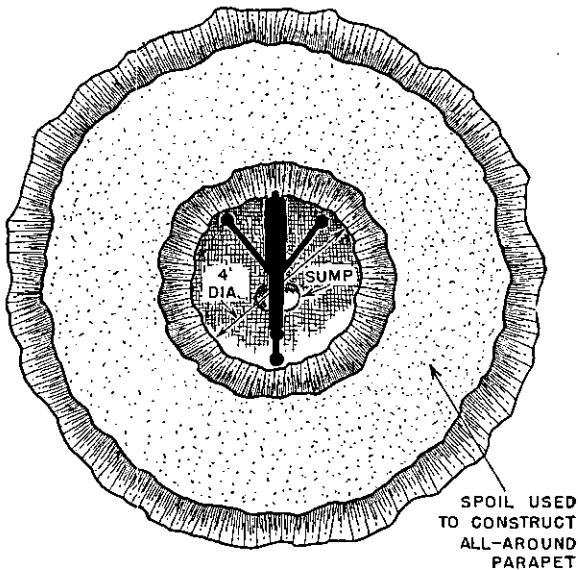

PLAN

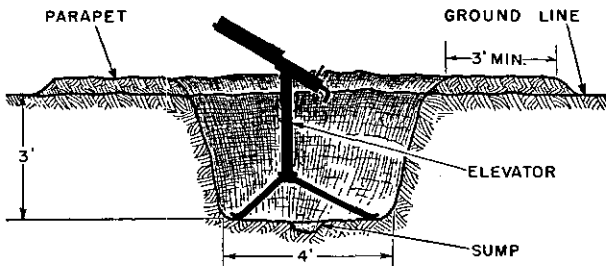

PROFILE

Figure 29. Antiaircraft emplacement for caliber .30 machine gun (heavy) with elevator. (Camouflage omitted.)

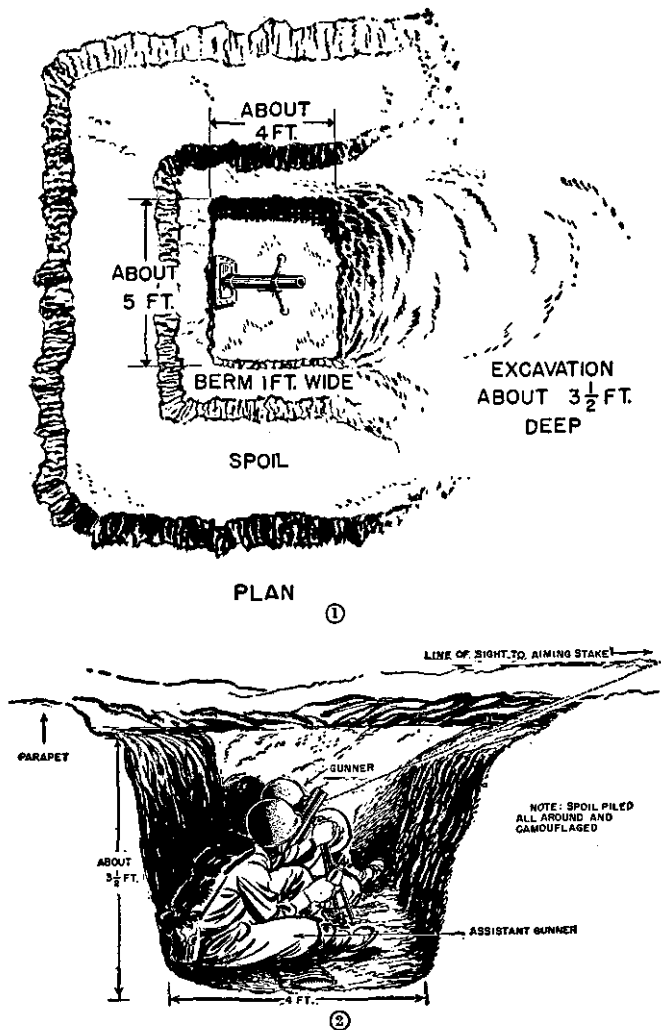

Figure 30. Open emplacement for 60-mm mortar. (Camouflage omitted.)

b. Two-foxhole type (fig. 31). This shows the 60-mm. mortar in action with only the base plate dug in, the crew operating from one-man foxholes. This two-foxhole type of emplacement is preferred when the mortar is in defilade.

42. 81-MM MORTAR EMPLACEMENT (fig. 32). Except for somewhat larger dimensions, this emplacement is the same as the open type described above for the 60-mm mortar. A revetted ammunition niche may be built into the side of the pit.

43. ROCKET LAUNCHER. There are two types of emplacement for this weapon, the pit-foxhole type and the pit type.

a. Pit-foxhole type (fig. 33 ①). This emplacement is a circular pit, 3 feet in diameter and about 3½ feet deep, large enough for two men. It permits the assistant rocketeer to turn with the traversing weapon, so that he is never behind it when it is fired. The emplacement is shallow enough to permit the rear end of the rocket launcher at maximum elevation to be clear of the parapet, thus insuring that the hot back-blast from the rockets is not deflected to the occupants. This emplacement is not tankproof. Therefore foxholes for the crew are dug nearby. *As the antitank mission of this weapon requires that it be kept in action against hostile tanks until the last possible moment, these foxholes will be occupied only when a tank is about to overrun the emplacement.*

b. Pit type (fig. 33 ②). In firm soil the diameter of the circular pit (fig. 33 ①) can be increased to 4 feet and an additional circular pit 2 feet deep and 2 feet in diameter excavated in the center. This leaves a circular

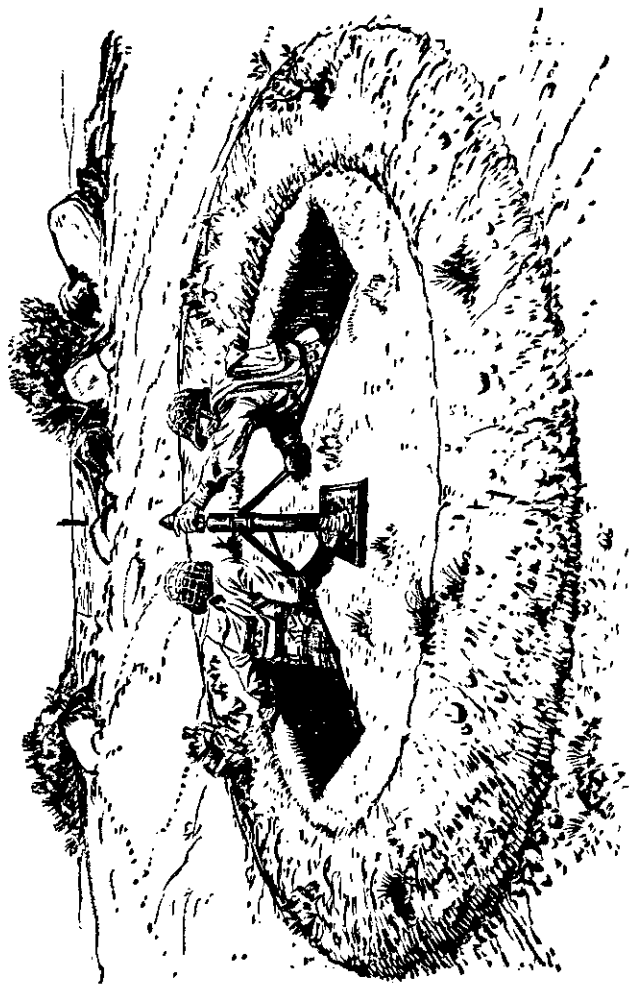
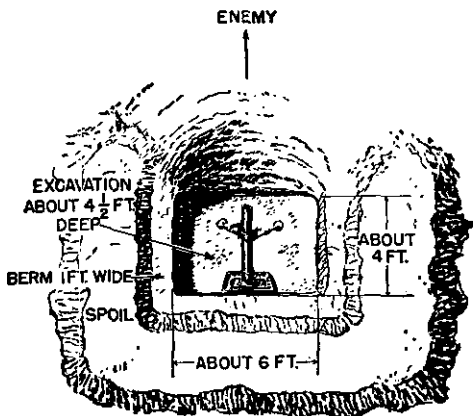
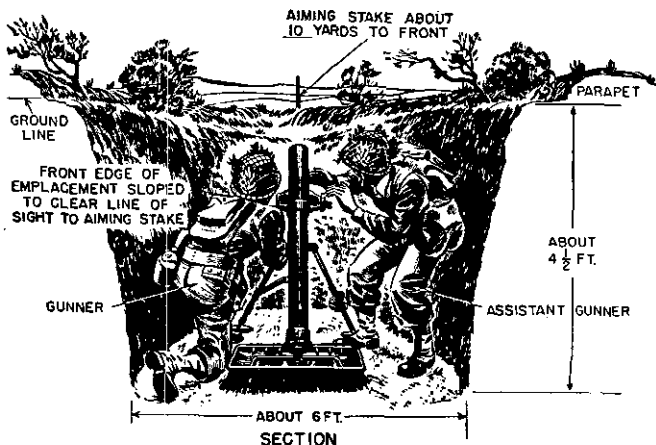

Figure 31. Two-foxhole emplacement for 60-mm mortar. (Camouflage omitted.)



PLAN

①



SECTION

②

Figure 32. 81-mm mortar emplacement. (Camouflage omitted.)

fire step 1 foot wide and about 3½ feet below the surface. When tanks appear about to overrun the position, the rocketeer and assistant rocketeer crouch down into the lower pit. When the tanks have passed, the rocket launcher quickly is returned to action.



PERSPECTIVE VIEW

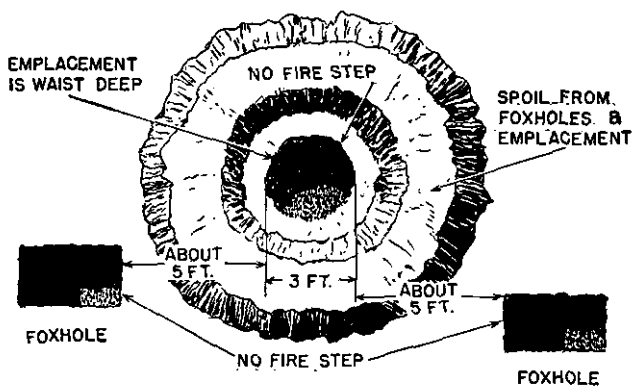

PLAN

① Pit-foxhole type.

Figure 33. Emplacements for antitank rocket launcher. (Camouflage omitted).

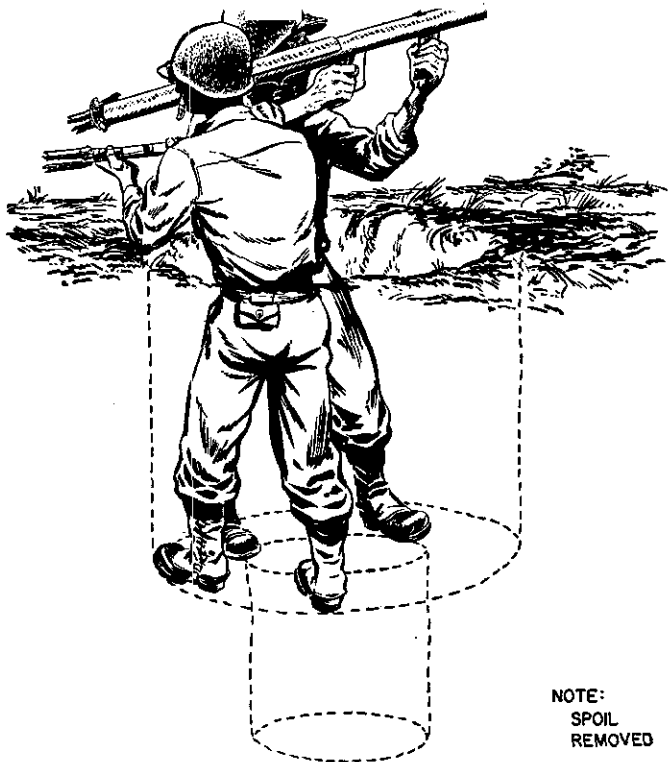

NOTE:
SPOIL
REMOVED

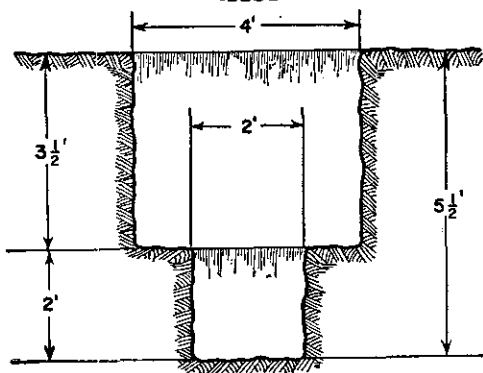

SECTION

② Pit type.

Figure 33—Continued.

44. 37-MM ANTITANK GUN EMPLACEMENT. For this weapon there are three standard types of emplacement, each adapted to a special situation. For flat terrain the circular emplacement (fig. 34) is preferred, since it permits all-around fire. For sloping terrain

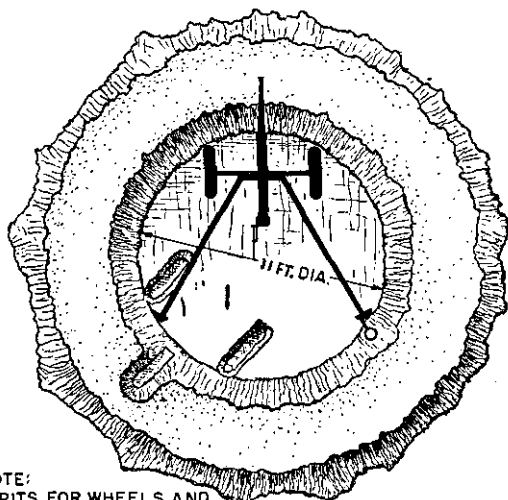

NOTE:
 PITS FOR WHEELS AND
 FOR BARREL ARE DUG.
 WHEN NOT FIRING, GUN
 IS PLACED IN THESE
 PITS SO AS TO BE BELOW
 LEVEL OF PARAPET

PLAN



SECTION

①

Figure 34. Circular type emplacement for 37-mm antitank gun.
 (Camouflage omitted.)

the rectangular-pit emplacement with ramp (fig. 35) is preferred, since it gives partial defilade and protection against ground observation. When the direction of enemy approach can be foreseen definitely, as in covering a road block in a defile, the fan type emplacement (fig. 36) is preferred, since the gun can be fired instantly without being moved from the cover position.

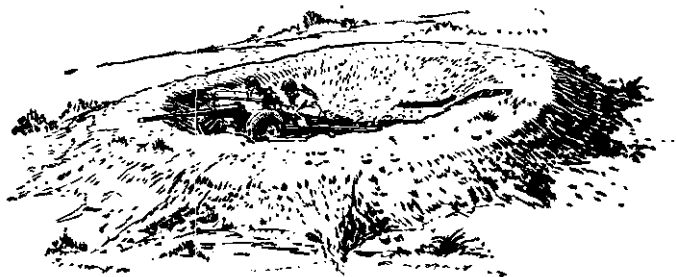

②

Figure 34—Continued.

a. Circular type emplacement (fig. 34). This emplacement consists of a circular pit, 11 feet in diameter and 1 foot deep, measured from ground level, with an all-around parapet 4 feet wide and approximately 9 inches high. The banks should be sloped so that the gun can be moved into and out of the emplacement. Pits for the wheels and a slit in the parapet for the gun barrel allow the gun to be lowered below the parapet when not firing, at which time the crew takes cover in nearby foxholes. An ammunition pit may be dug in the center of the emplacement or into the parapet. Additional ammunition is placed in nearby shelters. The gun is maneuvered quickly to fire in any direction by elevating the barrel, lifting the trails, backing the gun

to the center of the emplacement, turning it in the desired direction, and pushing it forward against the bank.

b. Rectangular pit type emplacement (fig. 35). This emplacement consists of a rectangular pit $10\frac{1}{2}$ feet wide, by 14 feet long, and $3\frac{1}{2}$ feet deep. To get the gun into and out of the pit, a ramp is dug either straight out of the pit or at an angle thereto, depending upon the sector of fire assigned to the gun. If the ramp is turned at an angle to the pit, the elbow is curved so that the gun can be moved around the corner. The gun is backed into the rectangular pit when not in firing position. The spoil is piled alongside the excavation to form a parapet. Several foxholes may be dug inside the emplacement without interfering with the movement of the weapon. Additional foxholes are dug nearby for the remaining members of the gun crew.

c. Fan type emplacement (fig. 36). This type of emplacement permits little traverse but great speed in going into action. The ramp is to the rear of the emplacement.

45. 57-MM ANTITANK GUN EMPLACEMENT. Figure 37 illustrates the basic type of emplacement for this weapon. It permits fire through an arc of approximately 110° , and even more if protection is sacrificed by modifying the parapet. The ramp normally is in rear of the emplacement, but it may be to the front if terrain conditions require. The spoil is piled on both sides of the emplacement to form a parapet approximately $2\frac{1}{2}$ feet high and 3 feet thick. Foxholes for the gunner and the assistant gunner are dug within the emplacement. Additional foxholes for other members of the crew are dug nearby.

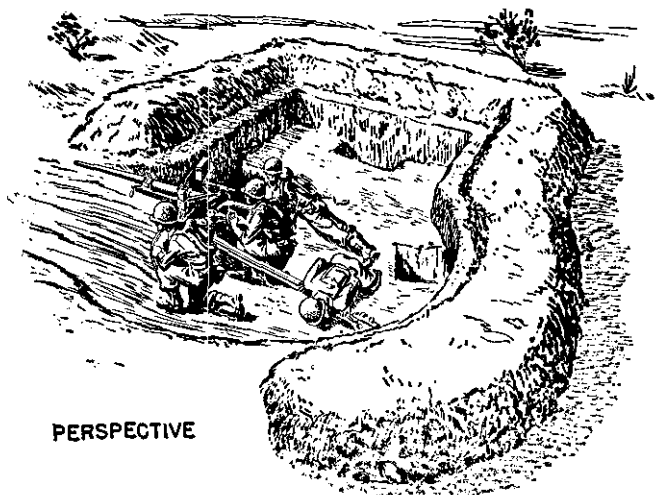

PERSPECTIVE

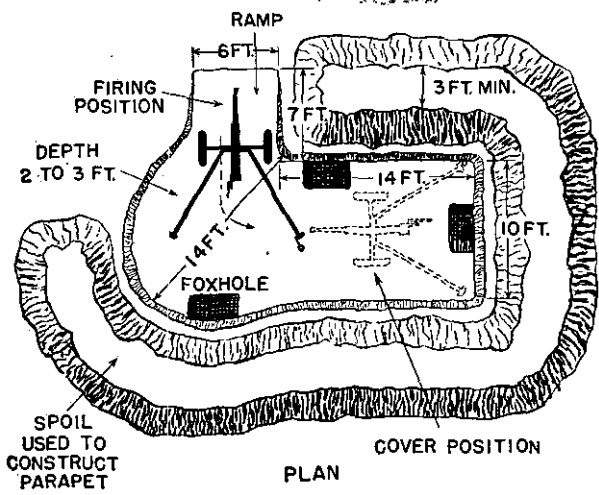
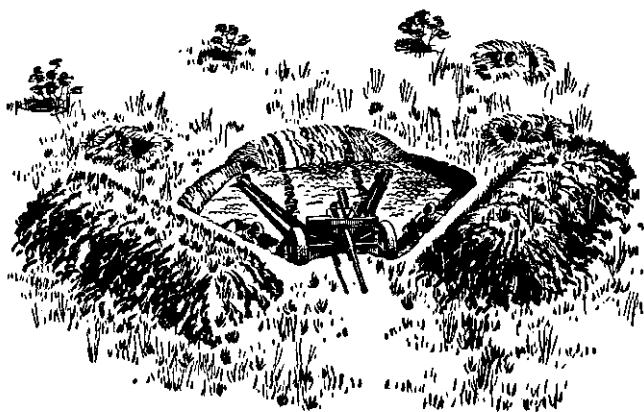
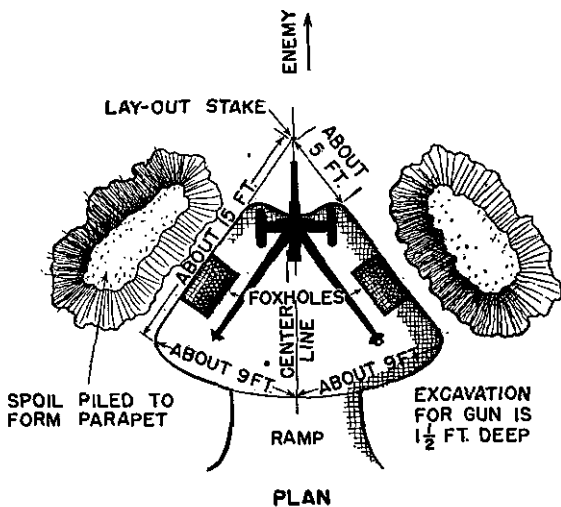

Figure 35. Rectangular pit type emplacement for 37-mm anti-tank gun. (Camouflage omitted.)



PERSPECTIVE VIEW



PLAN

Figure 36. Fan type emplacement for 37-mm antitank gun.
(Camouflage omitted.)

46. 105-MM HOWITZER M3 EMPLACEMENT. Figure 38 illustrates a circular emplacement, 19 feet in diameter, permitting all-around fire. The pit is dug

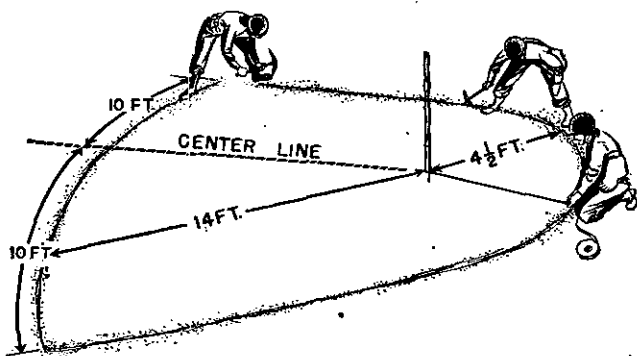
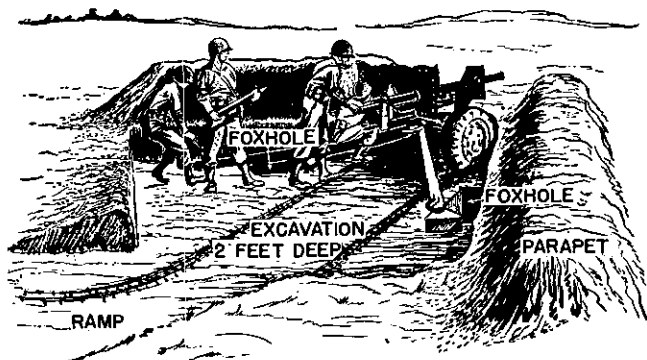
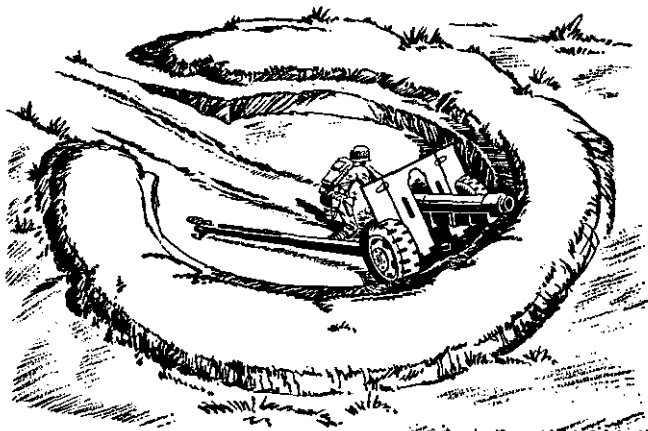
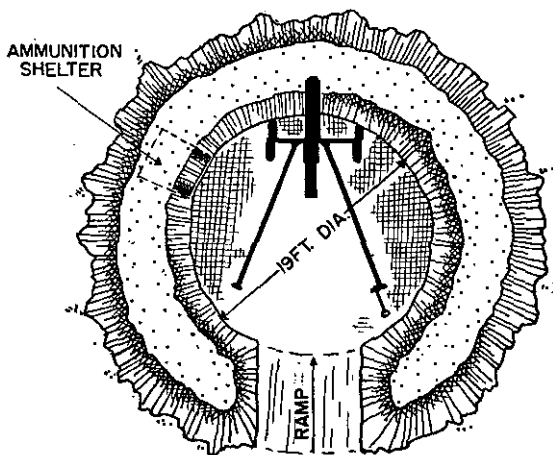

Figure 37. Fan type emplacement for 57-mm antitank gun. (Camouflage omitted. Excavation is 2 feet deep.)

about 2 feet deep and the spoil is piled in a low parapet all around the emplacement. A ramp is dug to the rear. Foxholes for members of the crew are dug nearby.



PERSPECTIVE VIEW



PLAN

Figure 38. Emplacement for 105-mm howitzer M3. (Camouflage omitted.)

SECTION IV

SPECIAL AND STANDARD TRENCH

47. SPECIAL TRENCH. a. Purpose. To meet the needs of the field artillery the special trench (fig. 39) has been developed. Where several men must be provided protection within a limited area, special trenches frequently are used because they take less space than foxholes. Because they are especially suitable for use

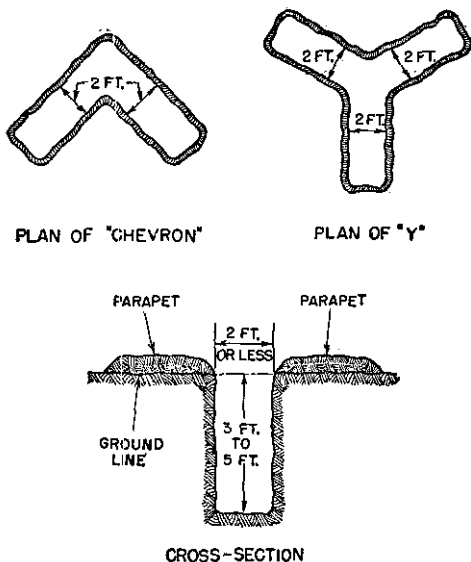

NOTE: LEGS OR BAYS ARE 6 FT. OR LESS IN LENGTH

Figure 39. Cross section and typical plans of special trench used with artillery emplacements. (Camouflage omitted.)

under a camouflage net, they normally are constructed and occupied by artillerymen and by personnel at rear installations.

b. Construction. The special trench is 2 feet wide, or less, and from 3 to 5 feet deep. It is dug in short lengths, in the shape of a chevron, a Y, or any other

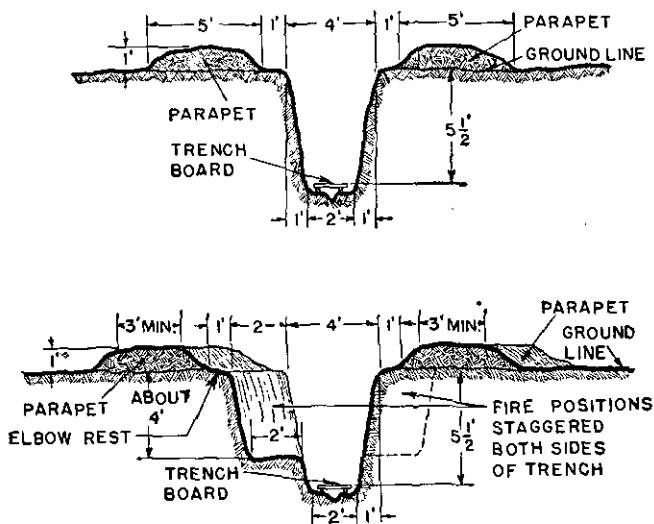

① Cross section.

Figure 40. Standard trench.

trace which fits into the space available. Changes in direction are made to reduce the effects of bombs, artillery shells, or aerial strafing.

48. STANDARD TRENCH. a. Purpose. The standard trench (fig. 40) offers much less protection, is harder to conceal, and requires more time and labor to construct than foxholes. However, it improves con-

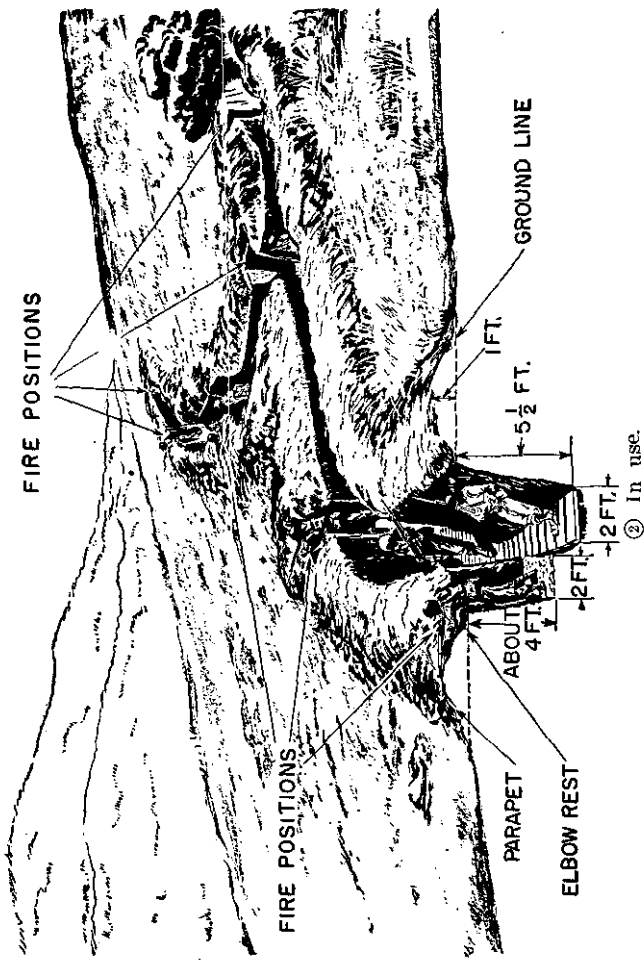

Figure 40. Standard trench—Continued.

munication, control, supply, and evacuation. The use of trenches is a command decision. Standard trenches might be used to advantage in the following situations:

(1) Communication trenches in stabilized situations where either concealment is available or the advantages to be gained justify exposure.

(2) Entrances to shelters or groups of shelters.

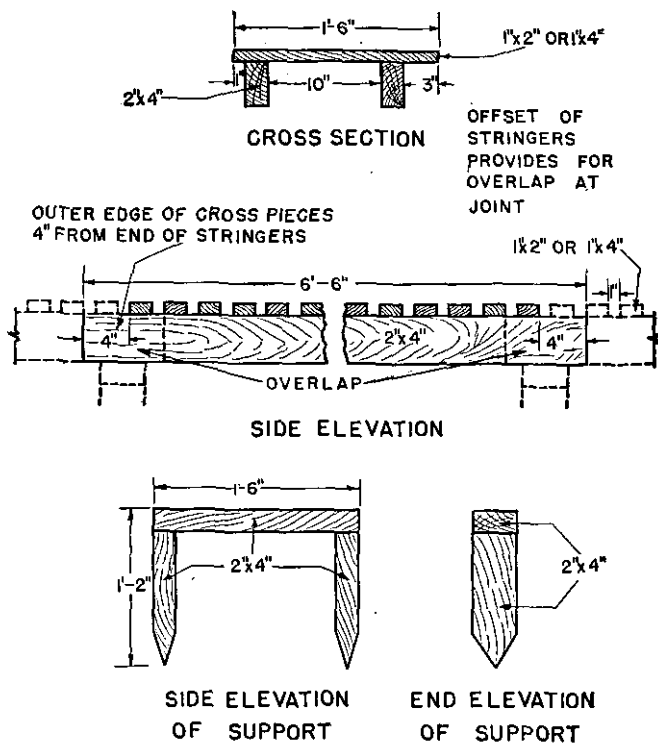

Figure 41. Detail of trench board and support.

(3) Operations in extreme cold, where the soldiers, who remain in heated shelters until the last minute, must be able to get to firing positions under cover.

(4) In jungle and forest warfare, where movement of tanks is impossible or very restricted and where there is concealment from all types of enemy observation, particularly aerial photography.

b. Construction. The standard trench (fig. 40①) is 4 feet wide at the top, 2 feet wide at the bottom, and 5½ feet deep. The spoil is used to construct an irregular parapet 3 feet wide on each side of the trench. To aid in concealment, the trench is irregular in plan (fig. 40②) and is built in short sections. Trench boards (fig. 41) should be installed in all standard trenches. Lumber or cut timbers may be used. The trench is deepened so the top of the trench board is 5½ feet down, and the bottom of the trench is shaped into a trough for drainage. In soft ground, supports for flooring are required.

c. Fire positions. The standard trench is used either as a fire or communications trench. Fire positions (fig. 40) are staggered 5 to 10 yards apart on both sides of the trench. They are dug 2 feet wide, 2½ feet into the trench wall, and deep enough so the ground line is chest high. Fire positions are constructed in all standard trenches both to increase combat effectiveness and to prevent the enemy from distinguishing between fire and communication trenches.

SECTION V

FIELD ARTILLERY

EMPLACEMENTS

49. GENERAL. a. This section is a guide to the construction of protective works for field artillery weapons and personnel. Field artillery field fortifications provide protection for—

(1) Individuals and small groups such as observers, command post personnel, the battery executive, switch-board operator, and others.

(2) Ammunition.

(3) Gun crews.

b. Fortifications are planned to—

(1) Permit delivery of fire within prescribed zones.

(2) Permit direct laying against tanks.

(3) Take advantage of ground formations to lessen labor.

(4) Take advantage of natural cover and concealment.

(5) Allow the piece to be moved quickly to an alternate position.

(6) Provide personnel protection against artillery fire and air bombardment.

(7) Be simple enough to construct with minimum effort and time.

(8) Provide comfort during prolonged occupation.

c. Fortifications are begun as soon as practicable after positions have been selected. They are so planned that their progressive improvement is possible, using tools and materials supplied in tables of equipment, supplemented only by such additional material as is locally available. It should not be assumed that the occupation of a position may be so brief that fortifications are unnecessary.

50. PRIORITY OF CONSTRUCTION. a. On going into position, work is done to gain the following results, listed in their general order of priority:

(1) Ability to deliver fire on time.

(2) Concealment.

(3) Protection of personnel and ammunition.

(4) Alternate firing positions. Sometimes this may be third priority.

(5) Other protective measures.

b. The following is an example of the procedure followed by a 105-mm howitzer section in daylight occupation of a previously selected position:

(1) Place the piece in firing position, prepared for all-around fire if required; lay the piece and otherwise prepare to execute fire missions. Concealment is taken into account in selection of the position, and continuously thereafter.

(2) Construct necessary camouflage.

(3) Dig entrenchments for personnel and shelters for ammunition.

(4) Repeat above procedure for alternate positions.

51. PROTECTION FOR PERSONNEL. Standard types of entrenchments are employed for protection against aerial and artillery bombardment as well as possible ground attack.

a. Personnel at supply points, in bivouacs or assembly areas, and at installations other than gun emplacements are best protected in foxholes (par. 31) or prone shelters (par. 34).

b. Personnel at gun emplacements may utilize special trenches (par. 47).

c. Personnel employed as observers occupy modified foxholes or covered observation posts (par. 36).

d. In stable situations personnel protection may be increased by constructing appropriate shelters (ch. 5).

52. AMMUNITION SHELTERS. The construction of ammunition shelters begins as soon as the battery has prepared for firing and is concealed (par. 50). Shelters

are so located and constructed that they are well concealed, protect ammunition against hostile fire and the weather, and contain the quantities desired near where they are to be used. Usually projectiles, powder charges, fuses, and primers are stored in separate shelters, at least two shelters for each item, so that a direct hit cannot destroy all of any one of them. The protection required for the several components of separate loading ammunition is the same as for complete rounds of fixed or semifixed ammunition. The following methods are employed :

a. Initially, or where ground conditions limit excavation, ammunition is placed in natural depressions and dispersed in relatively small quantities.

b. Pits may be hastily dug, and branches or rocks placed at the bottom to prevent contact of ammunition with wet earth.

c. Time permitting, appropriate shelters may be constructed. Representative shelters for 105-mm and 155-mm ammunition are shown in figures 42, 43, and 44. For further data concerning the storage and protection of ammunition in the field, the quantity of ammunition per shelter, and distance from other shelters required to localize effects of a direct hit, consult the appropriate Field Manual or Technical Manual for the weapon concerned.

(1) **Shelters in parapet of emplacement.** Shelters constructed and concealed in emplacement parapets (figs. 42 and 43) are convenient for ammunition handling, inconspicuous, and also keep ammunition dry.

(2) **Open-pit type** (fig. 44). This shelter consists of a pit for handling and a shelf for stocking ammunition. Similar shelters may be used in battery dumps.

53. ANTI-AIRCRAFT EMPLACEMENT FOR CALIBER .50 MACHINE GUN, AIR-COOLED (fig. 45).

This is a circular pit, 9 feet in diameter and of such depth that the weapon can engage ground targets.

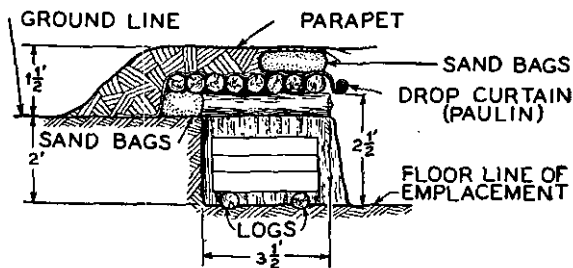

CROSS SECTION

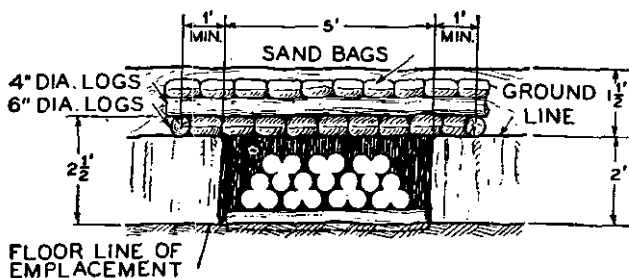

LONGITUDINAL SECTION

Figure 42. Ammunition shelter in parapet. (Camouflage omitted.)

54. EMBLACEMENTS FOR 105-MM AND 155-MM HOWITZERS AND 4.5-INCH GUN. Standard emplacements for all models of 105-mm and 155-mm how-

itzers and the 4.5-inch gun are so constructed that the same emplacement is suitable for any of these weapons. The standard emplacements for these weapons are of

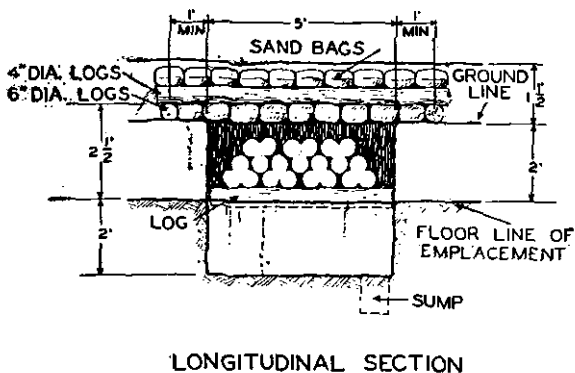
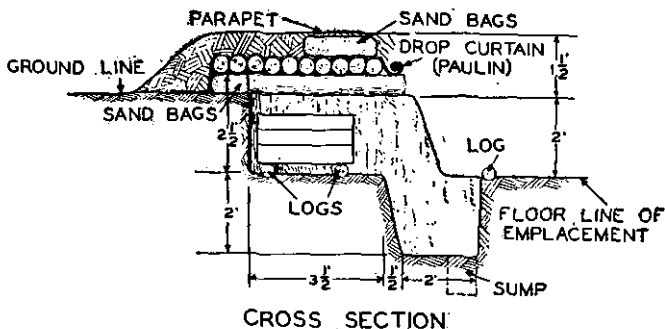

Figure 43. Ammunition shelter in parapet with handling pit. (Camouflage omitted.)

two types: the surface type and the 24-foot-diameter pit type.

a. **Surface type emplacement** (fig. 46). This consists of a built-up parapet of earth or sandbags in front

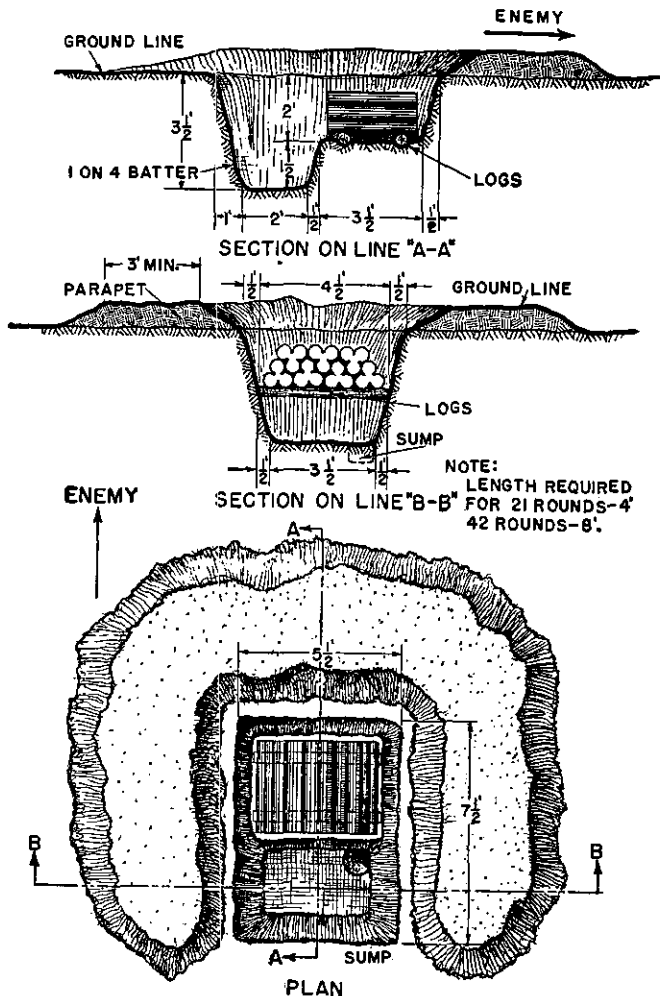

Figure 44. Open-pit type ammunition shelter. (Camouflage omitted.)

of the piece, an ammunition pit on its left side, and special trenches to accommodate the gun crew. Special trenches for six men usually are provided on the left of the piece and for two on the right.

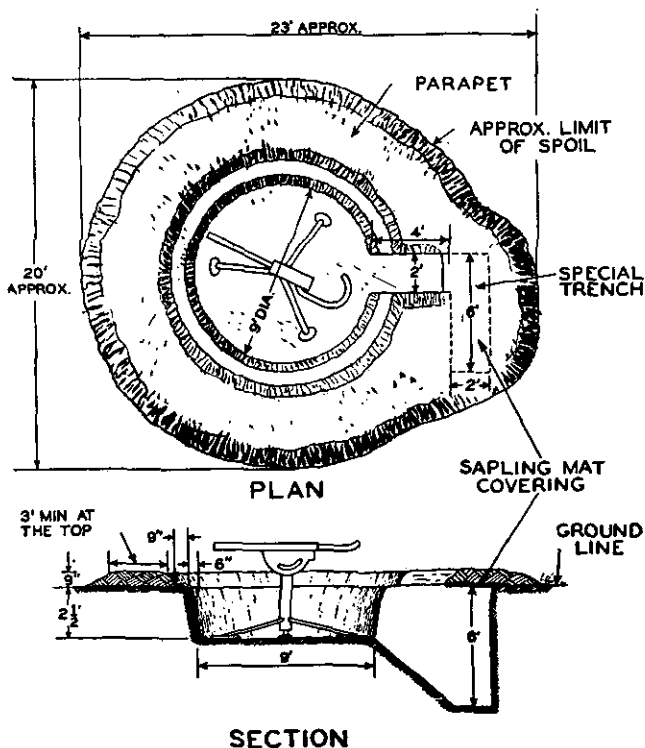

Figure 45. Antiaircraft emplacement for caliber .50 machine gun, air-cooled. (Camouflage omitted.)

b. 24-foot-diameter pit type emplacement (fig. 47). This consists of a circular pit, approximately 2 feet deep and 24 feet in diameter, with a sloping ramp at

the rear to get the piece into and out of the emplacement. The emplacement is surrounded by a parapet approximately $1\frac{1}{2}$ feet high except at the ramp, which usually is left open to permit rapid withdrawal of the piece. Ammunition shelters of the type indicated in paragraph 52 are located in the parapet on either side of the

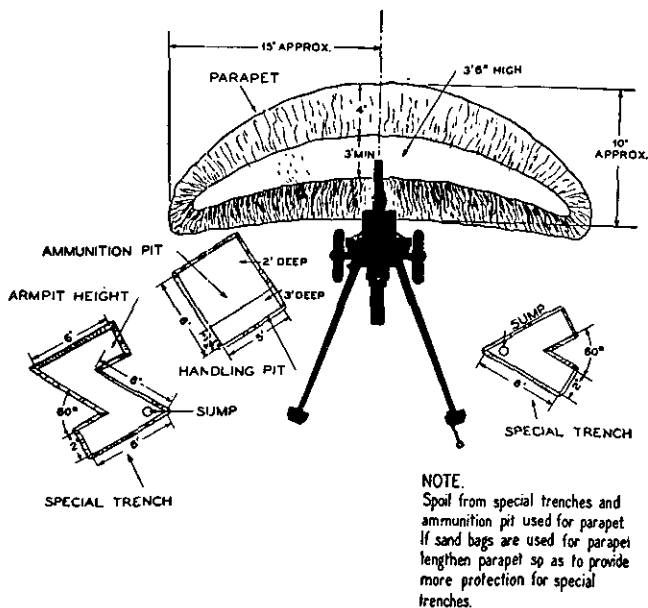
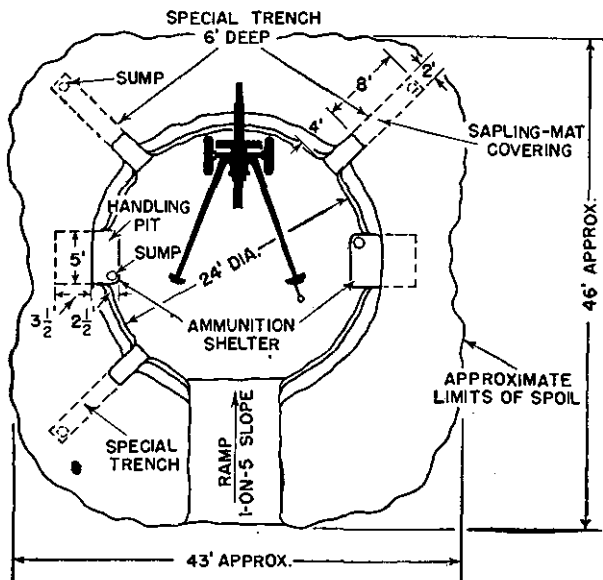

Figure 46. Surface type emplacement for 105-mm and 155-mm howitzers (all models) and 4.5-inch gun. (Camouflage omitted.)

piece. To save extra digging after the parapet is completed, covered special trenches, located under the parapet, are constructed either prior to or at the same time as the main pit. Spoil from the main pit, the ammunition shelters, and the special trenches is used to build the parapet.



PLAN

NOTE:

BY PULLING THE WEAPON TO THE REAR UNTIL THE AXLE IS IN THE CENTER OF THE EMPLACEMENT, THE WEAPON MAY BE SWUNG AROUND TO FIRE TO THE REAR OR IN ANY DESIRED DIRECTION (FOR ALL-AROUND DEFENSE).

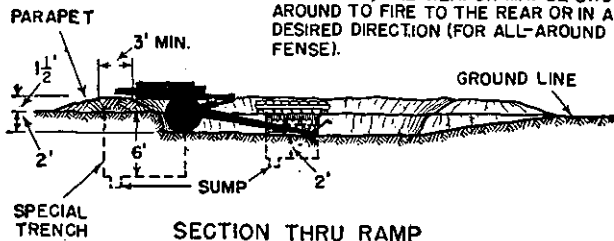

SECTION THRU RAMP

Figure 47. The 24-foot-diameter pit-type emplacement for 105-mm and 155-mm howitzers (all models) and 4.5-inch gun. (Camouflage omitted.)

55. EMPLACEMENTS FOR 155-MM GUN. a.

There are two similar types of emplacements, one for the 155-mm gun M1 (fig. 48) and the other for the 155-mm

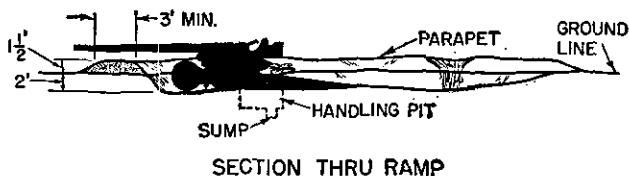
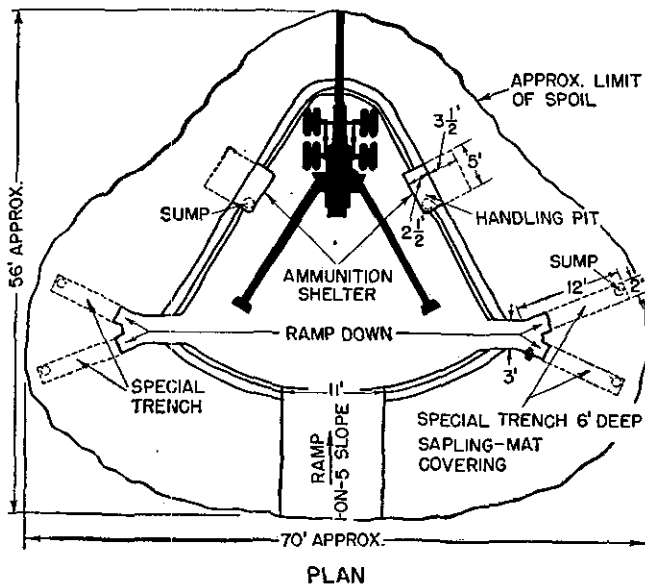

Figure 48. Emplacement for 155-mm gun M1. (Camouflage omitted.)

gun M2, M3, or modified GPF (fig. 50). The only difference in the general lay-out and construction of these two emplacements is that the emplacement for

the M1 gun is somewhat larger and has no recoil pit. An alternate emplacement is required if it is necessary to cover a greater sector of fire than that provided by normal traverse in the emplacement.

b. Each of the two type emplacements is a fan-shaped pit about 2 feet deep, with a ramp at the rear.

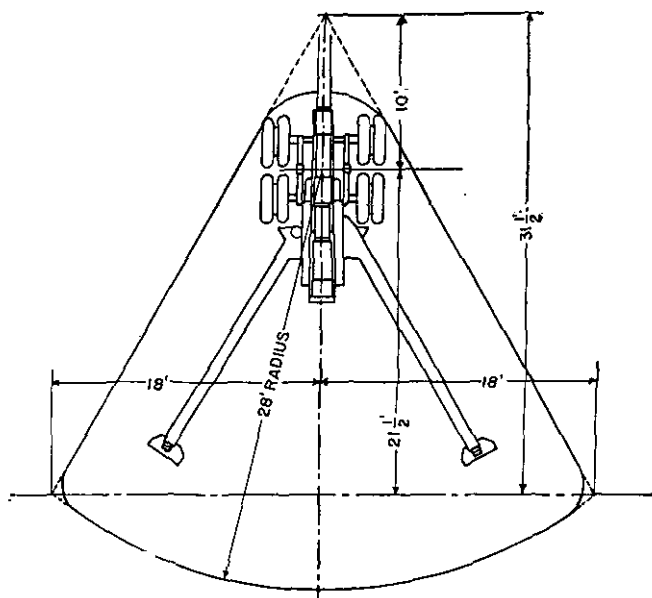
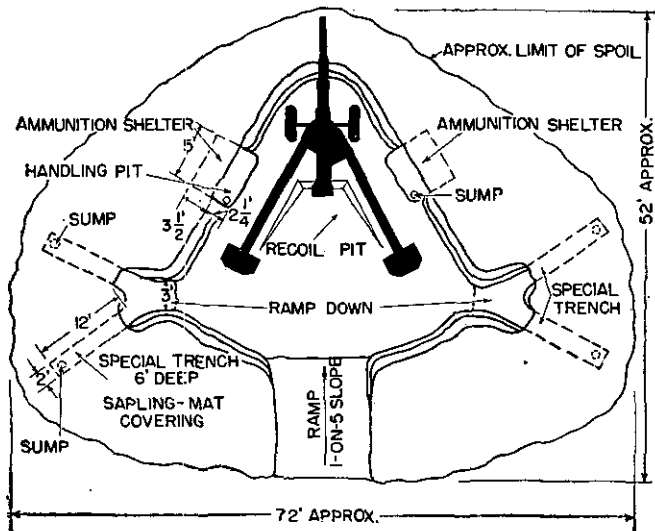

Figure 49. Lay-out of emplacement for 155-mm gun M1.

Ammunition shelters are located in the parapet on either side of the piece. Covered special trenches to accommodate the gun crew also are located under the parapet. The parapet and ramp are built as described in paragraph 54b above.

c. The outline of the emplacement is marked out on the ground, as indicated in figure 49 for the M1 gun,



PLAN

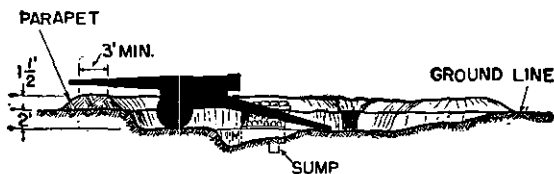

SECTION THRU RAMP

Figure 50. Emplacement for 155-mm gun M2, M3, or modified GPF. (Camouflage omitted.)

and in figure 51 for the M2, M3, or modified GPF. The center line of the emplacement is along the principal direction of fire of the weapon, which is indicated before lay-out and construction of the emplacement are started.

56. TRAIL SUPPORTS (fig. 52). Trail logs facilitate traversing the 105-mm howitzer beyond its normal limits. They are especially desirable if wide-angle or all-around fire is necessary. Except in wet or soft ground during continuous firing, the 155-mm gun and

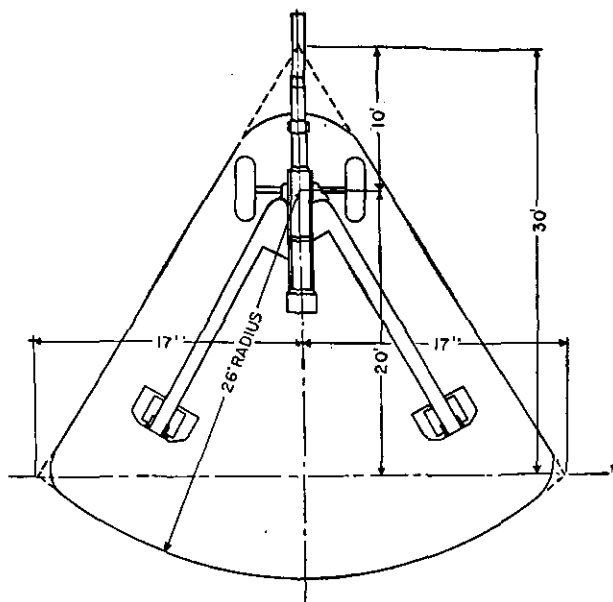

Figure 51. Lay-out of emplacement for 155-mm gun M2, M3, or modified GPF.

howitzer require no trail support beyond that afforded by the trail spade. This support is provided by placing a large log or timber under the shoe perpendicular to the trail. The timber should be 12 inches square and 12 feet long, extend 6 feet on each side of the spade, and be flush with the ground surface.

57. WEAPONS PLATFORM (fig. 53). If timber is available, an improvised log platform may be constructed by burying three or four sills in the ground

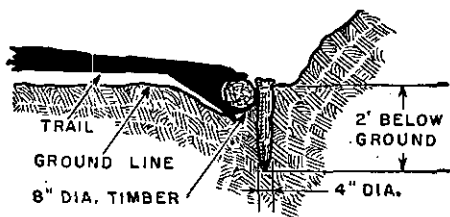
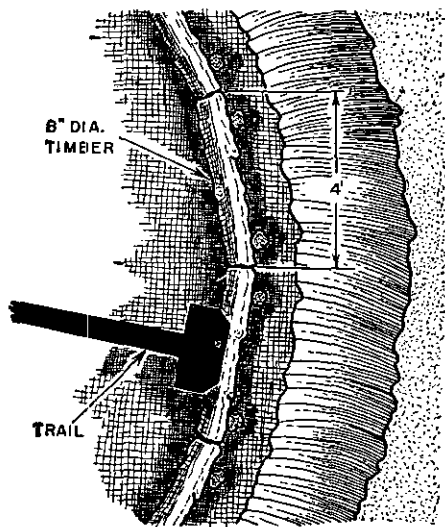

Figure 52. Detail of trail supports for 105-mm howitzer.

parallel to the direction of fire, and laying upon them at right angles, a row of *straight* logs. These can be held in place by wiring or spiking the top layer to the

sills, or by covering the entire platform with 6 inches of earth. The top of the completed platform should be flush with the ground on either side.

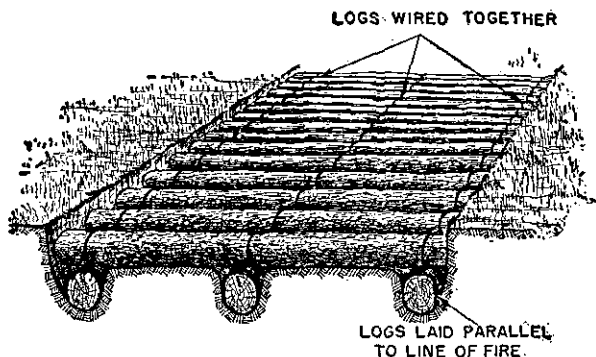

Figure 53. Gun platform for 105-mm howitzer.

SECTION VI

ANTIAIRCRAFT ARTILLERY EMPLACEMENTS

58. GENERAL. This section is a guide for constructing protective works for antiaircraft guns, personnel, and matériel. Such construction takes several hours. So that it can be done in an efficient and orderly manner, certain parts of the work are given priority. Highest priority *always* is given to the mission. Whenever possible, for purposes of secrecy, new positions are constructed and occupied during darkness, all camouflage being completed before dawn. The following outline gives, in general, the procedure to be followed in fortifying a position.

a. Emplace matériel ready for firing as soon as possible. If the position is to be excavated, matériel is emplaced off to the side of the final positions.

b. Dig foxholes or special trenches near the emplacement for personnel.

c. Provide hasty camouflage, if working in daytime.

d. Make necessary excavation at final position.

e. Emplace matériel in final position with minimum interference to mission, and put in firing order.

f. Continue to build up and fortify the position as time permits.

59. REQUIREMENTS. a. While it is desirable to give every protection to personnel and equipment, the prime consideration always must be the efficient use of the equipment. A typical fortification for antiaircraft matériel embodies the following features:

(1) A parapet 3 to 4 feet high surrounding the emplacement. The parapet should be at least 3 feet wide at the top, and its outside slope should be from 30° to 45°. See tables XXIII and XXIV for required thickness for different materials.

(2) An inner diameter of the absolute minimum permitting efficient operation. The inside walls should be made as steep as the soil permits, preferably a slope of 12 on 1.

(3) An inside depth permitting the gun or instrument to depress to its minimum elevation. If the guns are located on level ground or at the bottom of a valley where all targets must be above the horizontal, the parapet can be built to trunnion height.

(4) Barrel stops preventing fire into adjacent units.

(5) Provisions for drainage.

b. In stabilized situations it is desirable to remove the wheels of the 40-mm gun to a place of greater safety; but if the situation is such that the fire unit may have to move at a moment's notice, this cannot be done. Sandbagging the wheels is advisable, provided it does not interfere with operation of the weapon. Also, in stabilized situations the bogies of 90-mm guns are removed, provided a draw bar is available for the purpose. If they are not removed, they should be covered with sandbags for their protection.

60. SHELTERS. a. Personnel. Normally, protection is required against blast and splinters of shells and bombs and penetration of small-arms bullets. Such protection is obtained by dispersion and concealment and by use of foxholes (par. 31) or special trenches (par. 47) located in the immediate vicinity of the emplacement.

b. Ammunition. (1) Some ammunition is stored in niches in the parapet of the emplacement. Frequently ammunition cases buried in the parapet, with open ends flush with the inside face of the parapet, are used for this purpose; or types of shelters similar to those described in paragraph 52 may be used. A suitable cover must protect live ammunition from being struck by ejected shell cases.

(2) The bulk of the ammunition carried by the gun battery is stored in battery dumps. Usually two are built per battery. Where time is limited an open-pit type of ammunition shelter may be used. (See par. 52c(2).) However, shelters with 3 feet or more of overhead cover are better. A trench or pit covered by 8-inch or larger logs and earth is one suitable type. A cut-and-cover shelter, similar to the one shown in figure

86, may be used both as an ammunition shelter and to store extra equipment. A trench or sandbagged passageway with at least one right-angle turn to retard blast effect should lead to the entrance of the shelter.

61. GUN BATTERY EMPLACEMENTS. a. 90-mm antiaircraft gun M1 on M1A1 mount (fig. 54①). Unless it is possible to prepare the emplacement ahead of time, the emplacement for the gun on the M1A1 mount is built in two stages: first, the main pit, ramp, and outrigger trenches are excavated; the gun is then emplaced, leveled, and prepared for action; second, parapets are built and, when necessary, revetted; ammunition niches are provided; outriggers covered; and the ramp closed off. Note that—

(1) The outrigger trench is covered to prevent a break in the parapet, and yet in a manner to permit ready withdrawal of the outriggers. It is overlaid with brush or boards and covered with dirt in sufficient depth to make a continuous parapet around the gun.

(2) Protection is furnished in the ramp by a wall of sandbags or a revetted dirt wall that can be readily removed.

(3) Four ammunition niches are provided. Each is formed by placing four boxes of ammunition in the parapet with ends flush with the inside wall and then removing the exposed end of each box.

(4) A short tunnel is built in the parapet for the power transmission cables.

b. 90-mm antiaircraft gun M2 on M2 mount (fig. 54②). The emplacement for a gun on the M2 mount is similar to that for one on the M1A1 mount described in **a** above, except that it is somewhat larger, has a ramp at either end, and has a greater inside depth.

c. 4.7-inch antiaircraft gun M1 on M1 mount (fig. 54③). The emplacement for the 4.7-inch antiaircraft gun is similar to that for the 90-mm gun M2 on mount

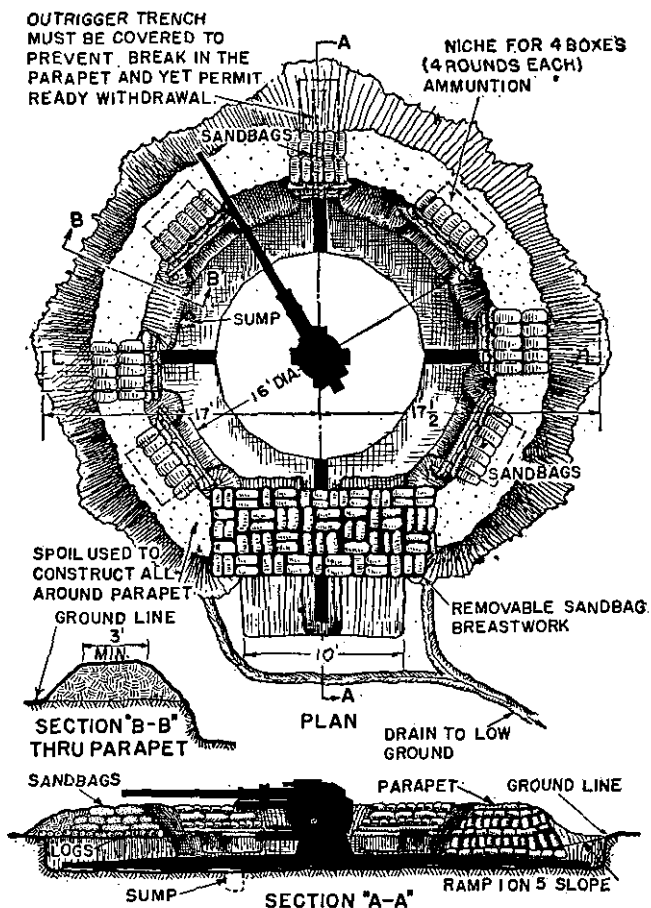

③ 90-mm antiaircraft gun M1 on M1A1 mount.

Figure 54. Gun battery emplacements. (Camouflage omitted.)

M2. Basically, it is a circular pit 22 feet in diameter and 6 feet 3 inches deep from the top of the parapet. The pit is provided with niches for the side outriggers and with two ramps for the front and rear bogies.

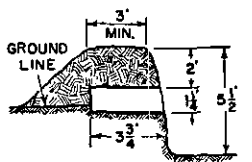
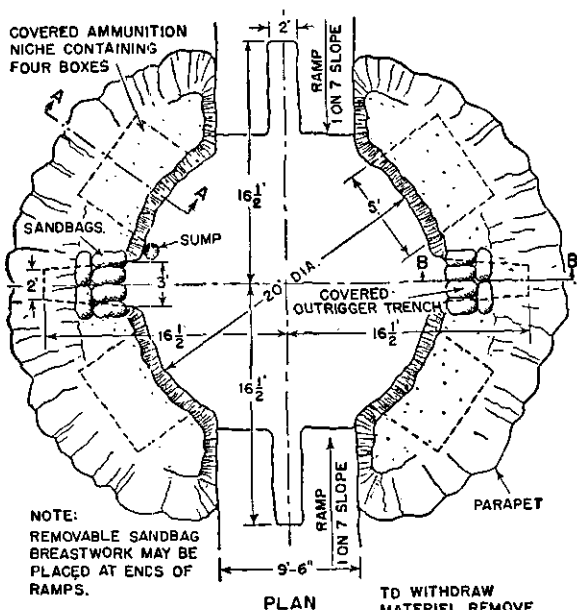

SECTION "A A"
THRU AMMUNITION NICHE

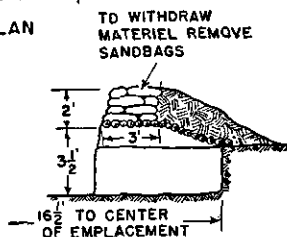

SECTION "B B"
THRU OUTRIGGER TRENCH

② 90-mm antiaircraft gun M2 on M2 mount.

Figure 54—Continued.

d. Power plant M7 (fig. 55). The emplacement for the M7 power plant is a rectangular pit $9\frac{1}{2}$ feet long, $8\frac{1}{2}$ feet wide, and $6\frac{1}{2}$ feet deep from top of parapet to bottom of pit. An extension should be connected to the

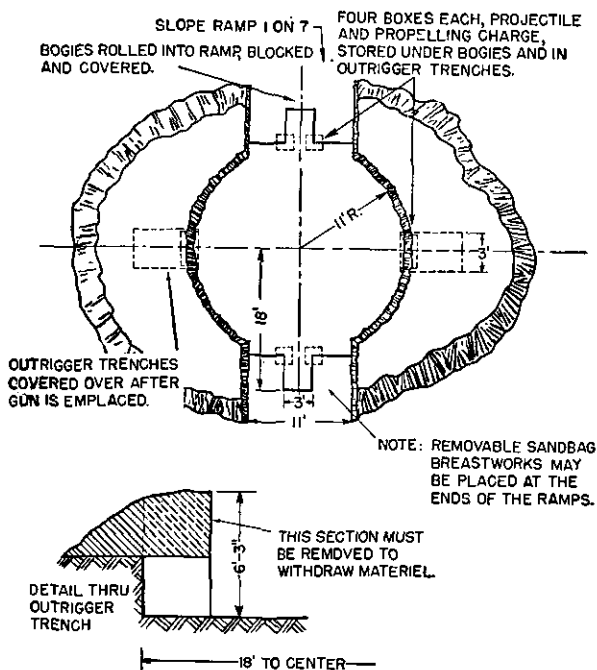

③ 4.7-inch antiaircraft gun M1 on M1 mount.

Figure 54—Continued.

exhaust to carry the fumes out of the emplacement. The transmission cable is buried, as indicated in *n* below.

e. Director M4 or M7 (fig. 56①). The emplacement for the M4 or M7 director is a circular pit about 8 feet in diameter and deep enough to protect operating

personnel while allowing full use of the director telescopes at low elevations.

f. Director, M9 or M10. (1) The *tracker* for the M9 or M10 director must be located in the open. Its

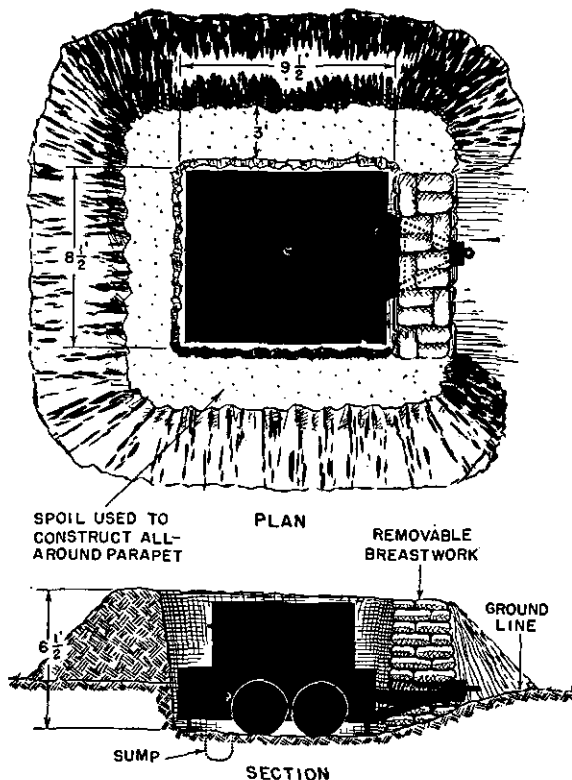
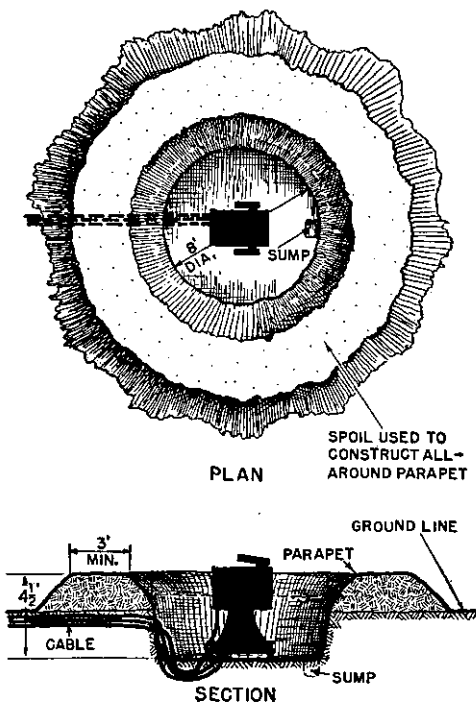

Figure 55. Emplacement for power plant M7. (Camouflage omitted.)

emplacement is a circular pit just large enough to accommodate the tracker head with seats attached. Except for depth it is about the same size as the pit for

the M7 director (fig. 56①). It is less deep since the telescopes are mounted lower.

(2) The *trailer* is emplaced in a rectangular pit 16 feet long, 10 feet wide, and 8 feet deep (fig. 56②).



① Emplacement for director M7 or M4. (Camouflage omitted.)

Figure 56.

g. Height finder M1 or M2 (fig. 57). The emplacement for the height finder is a circular pit 10 feet in diameter and deep enough to allow the ends of the height-finder tube just to clear the top of the parapet.

h. Height finder SCR-547 (fig. 58). The emplacement for the SCR-547 radio height finder is a pit large enough to accommodate the trailer. There is provision for swinging the outrigger jacks into position, and at one end of the pit is a ramp for removal of the trailer. This ramp is closed off with a sandbag parapet.

i. SCR-268 (fig. 59①). In emplacing the SCR-268 care must be taken that the outside of the parapet is

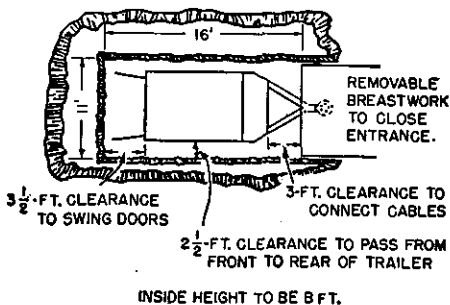

② Emplacement for M9 or M10 director trailer. (Camouflage omitted.)

Figure 56—Continued.

circular, so that it will have a constant effect on the elevation antenna.

j. SCR-545 (fig. 59②). The SCR-545 is emplaced in a rectangular pit 30 feet long, 16 feet wide, and 8 feet 4 inches deep from the top of the parapet. These dimensions allow a 4-foot clearance on all sides for necessary servicing.

k. SCR-584 (fig. 59③). The SCR-584 is emplaced in a rectangular pit 25 feet long, 14 feet wide, and 10 feet 4 inches deep from the top of the parapet. These dimensions allow a 4-foot clearance on the back and the

two sides, and a 1-foot clearance on the front for necessary servicing.

I. BC scope. The emplacement for the BC scope is similar to that for the searchlight control station shown

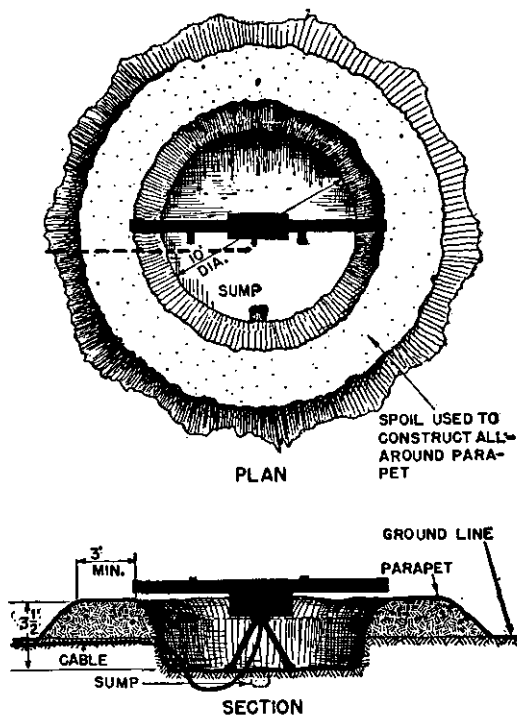

Figure 57. Emplacement for height finder M1 or M2. (Camouflage omitted.)

in figure 64. It is a circular pit just large enough to accommodate the instrument and manning detail, and of a depth that does not obstruct the view at low angular heights.

m. **Machine guns.** See paragraph 40.

n. **Cables.** For protection in static positions transmission cable may be buried in a shallow trench. A trench of the shape shown in figure 60 is best since it provides drainage away from the cable. If freezing is

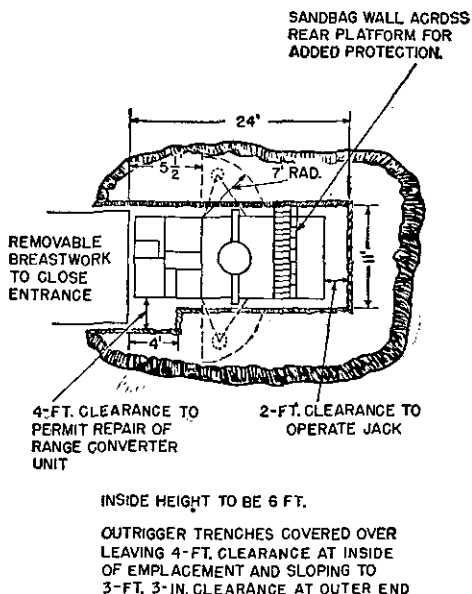
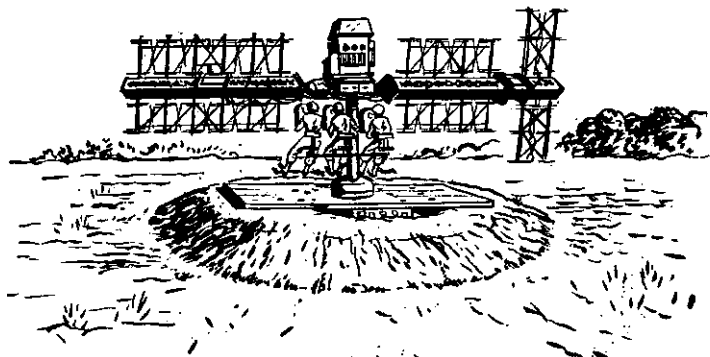

Figure 58. Emplacement for height finder SCR 547. (Camouflage omitted.)

likely, the cable is wrapped in several thicknesses of burlap or cloth to prevent damage when it is dug up later. In mobile situations cables normally are not buried.

62. EMPLACEMENT FOR FIRE UNIT OF 40-MM ANTI-AIRCRAFT ARTILLERY. a. **Gun and director.** The emplacement for gun and director of a 40-mm



PERSPECTIVE

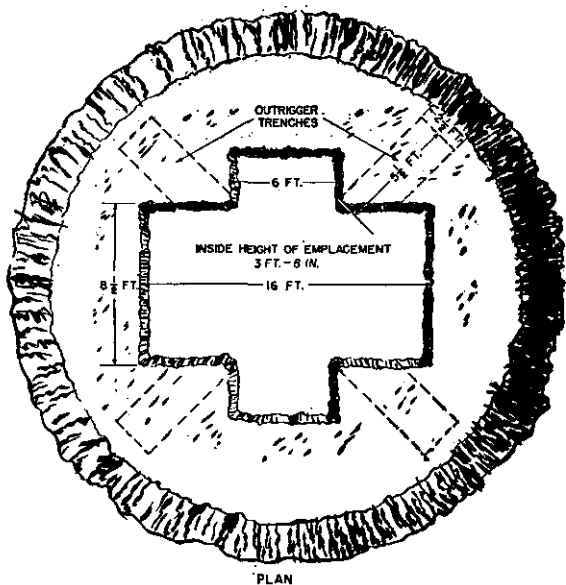

PLAN

① SCR-268.

Figure 59. Radar emplacements. (Camouflage omitted.)

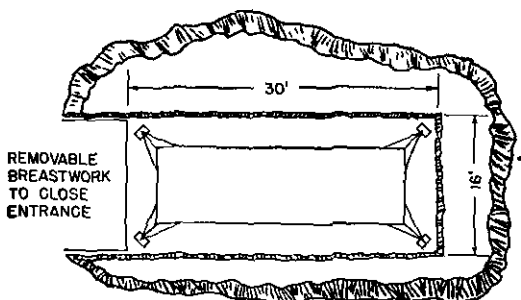

4-FT. CLEARANCE EACH END TO PERMIT JACKS TO BE EMPLACED.

4-FT. CLEARANCE EACH SIDE TO PERMIT REMOVAL OF COMPONENT BOXES.

INSIDE HEIGHT TO BE 8 FT. 4 IN.

② SCR-545.

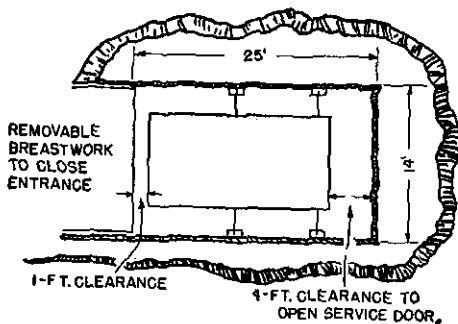

4-FT. CLEARANCE EACH SIDE TO PERMIT OPENING OF OPERATION DOORS.

INSIDE HEIGHT TO BE 10 FT. 4 IN.

③ SCR-584

Figure 59—Continued.

antiaircraft artillery fire unit is laid out as indicated in figure 61. With the director pit so located, the director is 13 feet from the pintle center of the gun and the dead arc extends 70° to the rear from the side outrigger. The dead arc extends 35° on either side of the gun-director line. The director pit is 6 feet in diameter. A

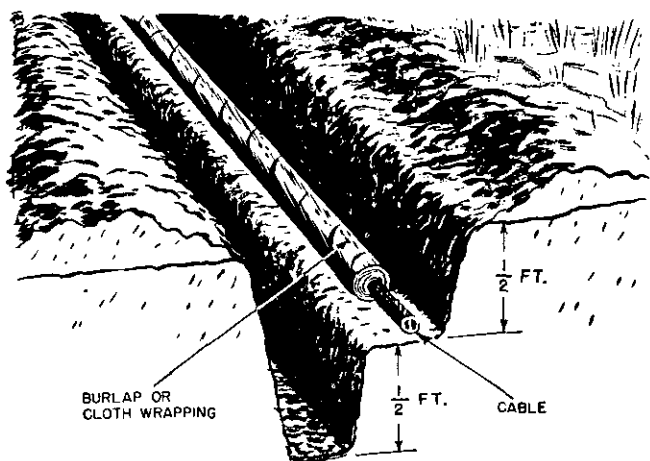

Figure 60. Trench for burying power-transmission cable.
(Camouflage omitted.)

short tunnel for the cable connects the director and gun pits. The inside height of the emplacement is not over 3 feet 9 inches to permit horizontal fire. An elevation stop is constructed to prevent the gun being depressed below 400 mils in dead arc. When the director is not used, there is no dead arc. The ramp is closed off with sandbags or an earth parapet. It is constructed as a separate unit to make removal easy. Four ammunition niches usually are provided in the sides of the pit.

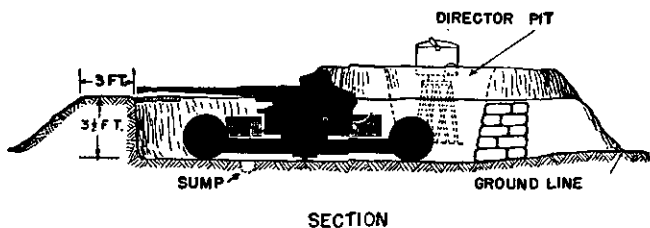
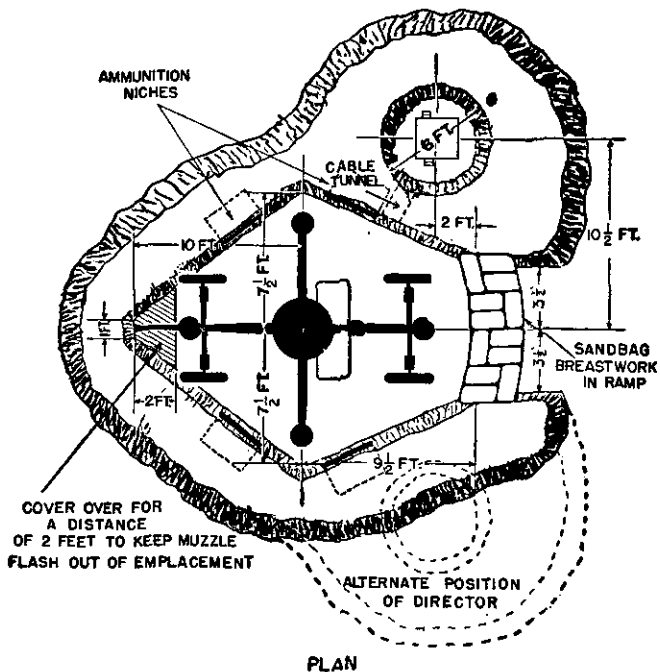

Figure 61. Emplacement for 40-mm antiaircraft gun and director. (Camouflage omitted.)

b. **Power plant M5 or M6** (fig. 62). The emplacement for an M5 or M6 power plant is a rectangular pit with a trench for the operator at one end. At static positions cables usually are buried (see par. 61 n). An

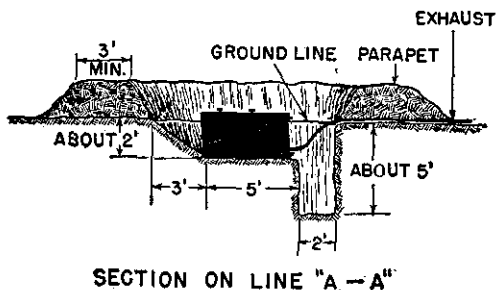
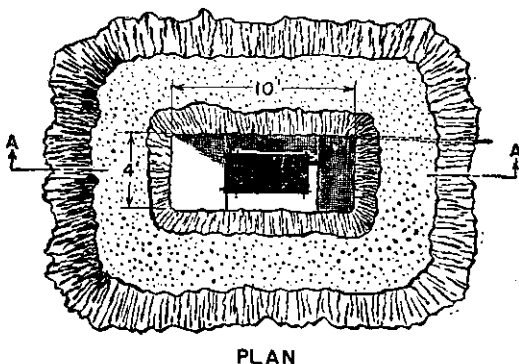

Figure 62. Emplacement for power plant M5 or M6.
(Camouflage omitted.)

extension should be provided for the exhaust to carry fumes out of the pit.

c. **Machine guns.** See paragraph 40.

63. ANTI-AIRCRAFT SEARCHLIGHT SECTION EMPLACEMENTS. a. Searchlight (fig. 63). The emplacement for the light is a circular pit $12\frac{1}{2}$ feet in diameter and 4 feet deep from the top of the parapet.

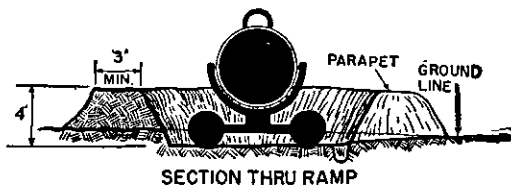
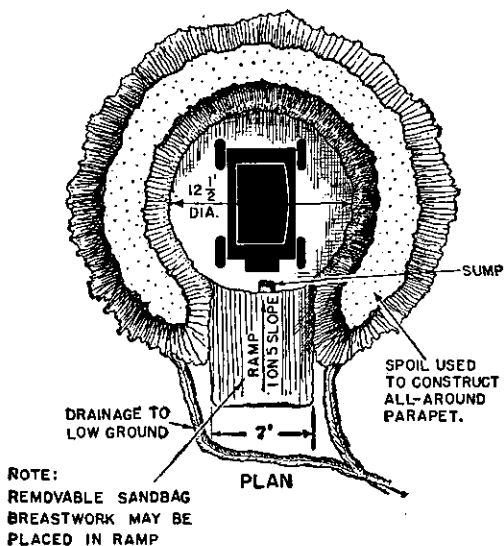

Figure 63. Searchlight emplacement. (Camouflage omitted.)

At one end is a ramp. It is closed off with a sandbag parapet after the light is in the pit. Protection is limited because of the necessity for illuminating planes at low heights.

b. Control station (fig. 64). The emplacement for the control station is a circular pit about $6\frac{1}{2}$ feet in diameter and 5 feet deep from the top of the parapet. It provides protection for all parts except the binocu-

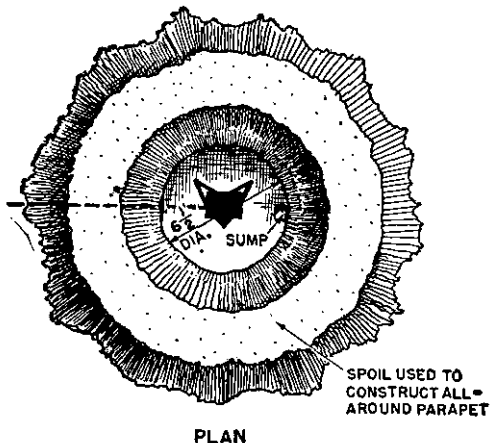

Figure 64. Emplacement for searchlight control station.
(Caumouflage omitted.)

lars; these must have an unobstructed view of low-flying airplanes.

c. Machine guns. See paragraph 40.

d. Power plant (fig. 65). The emplacement for the searchlight power plant is a rectangular pit 13 feet

long, 10 feet wide, and about 6 feet deep from the top of the parapet. It protects power plant and operator.

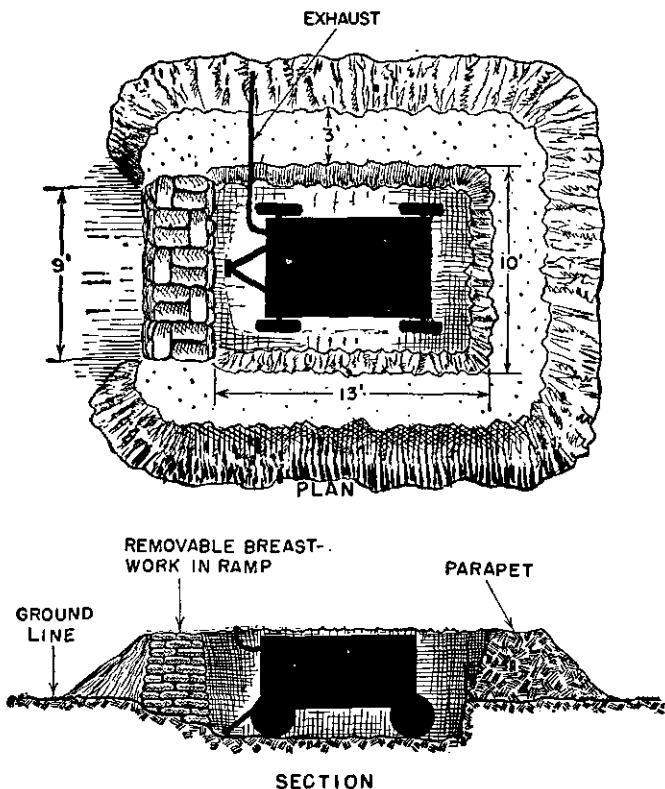

Figure 65. Emplacement for searchlight power plant. (Camouflage omitted.)

An extension should be placed on the exhaust pipe to carry fumes out of the pit. Searchlight cables should be buried the same as other cables.

64. CALIBER .50 ANTI-AIRCRAFT MACHINE GUNS. a. **Multiple, caliber .50 machine-gun carriage M51.** The emplacement for the M51 multiple, caliber .50 machine-gun carriage is similar to that for the M7 generator trailer (fig. 55) except that it is less deep, being about 4 to 4½ feet in depth, measured from the top of the parapet.

b. **Caliber .50 machine gun, water-cooled, M2, on M2A1 mount** (fig. 66). The emplacement for the M2 caliber .50 machine gun, water-cooled, on an M2A1 mount is a circular pit 8 feet in diameter and slightly less than 4 feet deep from the top of the parapet. There is an additional 3-foot excavation under the parapet on one side for water chest and ammunition.

c. **Caliber .50 machine gun, water-cooled, M2, on M3 mount.** The emplacement for the caliber .50 machine gun M2, water-cooled, on an M3 mount is the same as that for the M2A1 mount described above except that the depth is less, being about 3 feet from the top of the parapet, and the inside diameter is greater, being about 9 feet.

65. MISCELLANEOUS. a. **Command posts.** Command posts are protected whenever practicable. Shelters of the type described in chapter 5 give excellent protection but require considerable time and material to construct. An improvised command post affording protection from the weather and some protection from blast, splinters, and small-arms fire is shown in figure 67. A rectangular pit about waist deep is excavated and the spoil piled to form a parapet about 1½ feet back from the edge of the pit. The bows from a truck are placed over the pit, and the canvas top from the truck is placed over them to form a waterproof covering.

Similar shelter is given by a tent placed in a pit surrounded by a parapet.

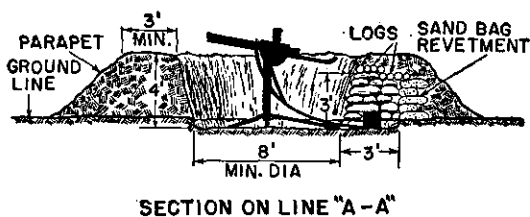
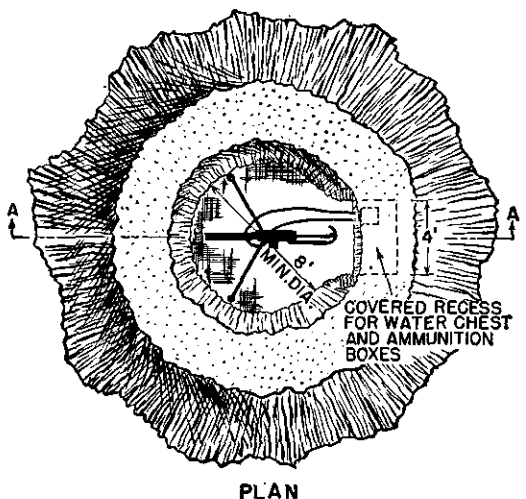

Figure 66. Emplacement for caliber .50 machine gun, water cooled, M2, on M2A1 mount. (Camouflage omitted.)

b. Kitchens. For protection, stoves may be placed in pits surrounded by parapets. However, when this is done, care must be exercised to prevent fires or explosions from gasoline fumes.

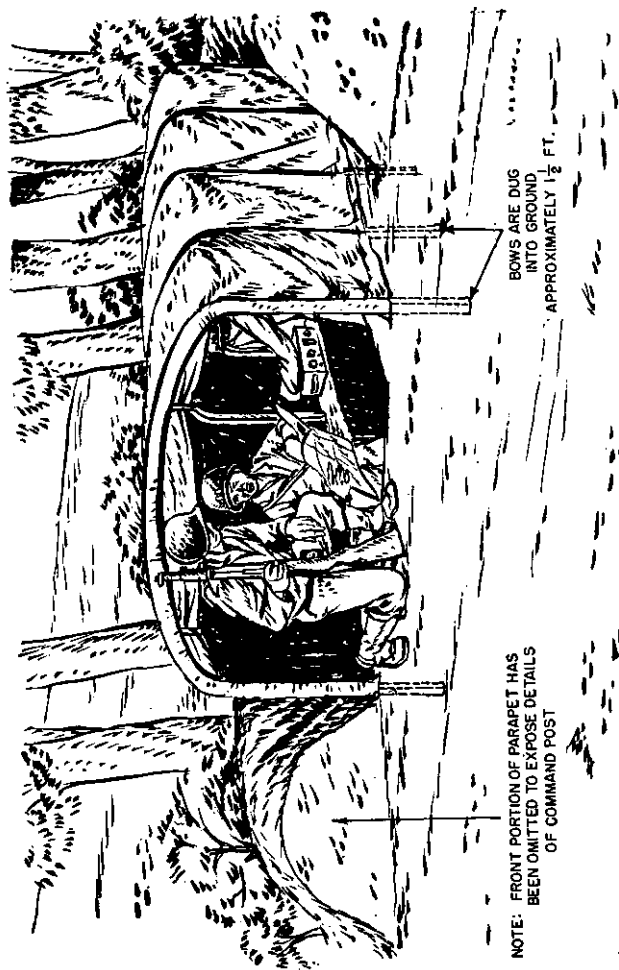

Figure 67. Improved command post using canvas top and bows from truck. (Camouflage omitted.)



NOTE: DEPTH MUST PERMIT GUNS
TO DELIVER HORIZONTAL FIRE.

IN STABILIZED SITUATIONS RAMP MAY
BE CLOSED WITH SANDBAGGED WALL.

Figure 68. Pit type emplacement for multiple-gun motor carriage. (Camouflage omitted.)

c. Radios. Radios are protected in pits; each pit is just large enough for radio and operator and deep enough that only the antenna is exposed.

d. Vehicles. The motor and the tires of a vehicle are the parts most vulnerable to fire effect. A large pit with entrance ramp will give such parts protection from blast, splinters, and small-arms fire. In hilly country partial protection is obtained by digging a cut in the side of a hill large enough to protect the front end of a vehicle driven into it. The rear tires are protected by sandbagging.

e. Multiple-gun motor carriage M13, M15, or M16 (fig. 68). Emplacements for multiple-gun motor carriages, which are mounted on standard half-tracks, consist of pits to fit the vehicles. Each pit must be of a depth to allow the weapons to fire horizontally, and its bottom must be nearly level. Access to the pit is by a sloped ramp. Usually the vehicle is backed into the pit to permit more rapid exit if the need arises.

CHAPTER 5

SHELTERS

SECTION I

GENERAL

66. SCOPE. This chapter covers various types of shelters employed in combat operations. Included is a discussion of tactical and technical requirements of shelters, methods of construction, and type designs. Ammunition shelters are described in paragraph 52.

67. CLASSIFICATION. a. **Based on degree of protection.** Protected shelters are classified according to the degree of protection they afford.

(1) **Blastproof and splinterproof shelters.** These shelters protect against rifle and machine-gun fire, grenades, and light mortars; splinters of most high-explosive shells and bombs; and blasts of 100-pound bombs exploding not closer than 50 feet. They do not protect against direct hits by bombs or artillery projectiles.

(2) **Light shellproof shelters.** Light shellproof shelters protect against direct hits by 105-mm shells and fragmentation bombs.

(3) Shellproof shelters. Shellproof shelters protect against continuous bombardment of shells up to 8 inches and direct hits by bombs up to 200 pounds, as well as against blasts of bombs up to 500 pounds exploding not nearer than 25 feet.

b. Based on method of construction. According to the method of construction, which depends on the character of the ground, materials available, and protection required, shelters may be further classified as follows:

(1) Surface. Surface shelters have maximum observation and exit facilities and require a minimum of labor; on the other hand, they are relatively conspicuous, require considerable cover material, and provide the least protection of the shelters mentioned here. They are seldom used for the protection of personnel in advanced positions unless they can be concealed in woods, on steep reverse slopes, or among buildings; or unless the underground water level is so close to the surface that the cut-and-cover type of shelter cannot be used. Shelters consisting of almost any type of small, improvised shed, covered with a layer of earth, may be used for the protection of ammunition and stores. These shelters should be of small capacity, well dispersed, and carefully concealed.

(2) Cut-and-cover. (a) This type, intermediate between the surface and the cave shelter, is constructed in an open excavation which is backfilled around and over the structure to the level of the original surface, or somewhat above. The resisting power of the overhead cover is increased by layers of concrete, steel beams, broken stones, or other materials with high resistance to penetration.

(b) The cut-and-cover shelter is better adapted than the cave shelter for use as a dressing station. It is more quickly constructed, more easily cleaned, better ventilated, and offers easier means of admission and evacuation of casualties. However, it usually requires much larger quantities of materials to provide the same protection, does not resist intensive shelling as well, and is harder to conceal.

(c) When the use of cave shelters is impractical because of surface or underground water, hardness of underlying rock, or the rapidity of exit required, cut-and-cover shelters sometimes may be used. They are also suitable in wooded areas or in buildings, where concealment is easy and ample material is available, and in situations requiring immediate shelter.

(d) Unless they are constructed partially or wholly of concrete, cut-and-cover shelters do not offer much protection against shells heavier than the 6-inch type.

(3) Cave. (a) Cave shelters are constructed entirely below the surface by mining methods, and have a cover of undisturbed earth. They are the least conspicuous of all types, afford effective protection before completion, and require the minimum material. Their disadvantages are: limited observation, congested living conditions, small exits, difficult drainage and ventilation, and time required to build.

(b) It is difficult to increase overhead protection of these shelters after completion, since protection depends upon depth at which the chamber is built. For this reason, in determining the depth, it is important not to underestimate the protection needed. On the other hand, it is equally important not to overestimate it because of the extra time, labor, and material involved.

68. TACTICAL CONSIDERATIONS AND REQUIREMENTS. **a. Purpose.** The primary purpose of a protected shelter is to permit troops or important installations to remain in comparative safety at or near their combat positions during hostile bombardment.

b. Terrain. Reverse slope positions, since they are difficult for artillery to hit and usually are easily drained, make excellent locations for shelters. Wooded areas and buildings, which provide materials and facilitate concealment, are also desirable.

c. Location. It is of the utmost importance near the front to have the shelters near where the troops who occupy them are needed. This rule is relatively less important toward the rear. Facilities for cover and concealment also influence the location of shelters. Every advantage which the tactical situation permits should be taken of natural shelter.

d. Ease of exit. (1) The occupants of a shelter must be able to get out rapidly. This is particularly important in shelters located near the front, where troops must be able to get out and occupy their fighting positions in the small time available between the enemy bombardment and the infantry assault.

(2) Exit is made easier by designing shelters with small capacity, minimum depth below ground, and unrestricted entrances.

(3) Large shelters are provided with at least two entrances, and preferably with a third for emergency use. Small shelters are provided with exits as necessary. Extra exits should emerge at a different place from the main exit and where practicable at points well concealed or camouflaged. Entrances should be spaced a minimum of 40 feet apart to avoid the danger of one shell or bomb burst blocking two entrances.

Large systems of cave shelters should provide one entrance for every 25 men.

e. Concealment. It is important that the location and number of shelters be concealed from enemy air and ground observation. Changes in the appearance of the terrain must be avoided. Materials and spoil must be concealed or camouflaged as the shelters are built. Strict camouflage discipline must be enforced among working parties. Surface shelters may be hidden by terrain features such as woods or buildings. Cut-and-cover shelters should be kept low.

f. Observation. If practicable, shelters should be located to afford necessary observation, and should be provided with means of observation, for example, loop-holes in a surface shelter, or a camouflaged periscope in the roof of a cut-and-cover shelter.

g. Application of types. Because of the time element and the construction difficulties in mobile warfare, the blastproof and splinterproof shelter is the type usually used. The necessity for shelter becomes greater as stabilization develops and details of the position become known to the enemy. In the rear parts of the defended area, larger and deeper shelters are both permissible and economical. These usually accommodate one or two squads or a platoon. They may be developed from the emergency shelters initially constructed. Shellproof and cave shelters are used only in stabilized situations.

h. Requirements for shelter in advanced positions. (1) Shelters in the advanced lines should be—

(a) Well distributed, placing troops close to their combat positions.

(b) Constructed without going to great depths, to provide for ease of exit.

(c) Provided with direct and easy exits, even at some sacrifice of cover.

(d) Of small capacity (from two to twelve men).

(e) Of a type that can be constructed rapidly.

(f) Concealed as thoroughly as possible.

(2) These requirements usually limit the type to the blastproof and splinterproof shelter.

i. Requirements for shelters in rear positions.

Shelters in rear positions may be larger and deeper than those at the front. Occupants usually have more time to emerge after warning of attack. Also in these areas shelters can be given maximum overhead cover to withstand bombardment of light bombs and heavy shells, giving occupying troops the necessary rest and a feeling of security. If underground water conditions permit, the shelters are built entirely below the ground. They are carefully hidden from enemy aerial observation.

69. TECHNICAL CONSIDERATIONS AND REQUIREMENTS. These include—

a. Subsurface conditions. Subsurface conditions such as extent and character of underlying rock, position and thickness of impervious and water-bearing strata, and amount of water to be controlled.

b. Facilities available. Facilities available, including time, personnel, tools, material, and transportation.

c. Drainage. Drainage of deep shelters sometimes becomes a complex problem. It includes exclusion of surface and rain water from the entrance, exclusion of seepage from the interior, and removal of water that has collected in the interior.

(1) **Surface and rain water.** Surface and rain water must be excluded from all shelter entrances. If shelter is enforced from a trench and drainage is slug-

gish, two sumps may be dug in the bottom of the trench, at least 6 feet from the sides of the entrance, and strongly revetted. The bottom of the trench in front of the entrance must then be graded to the sumps so that the highest point is in front of the entrance (fig. 97.) At times it is possible to dig a sump in front of the entrance and grade the trench so that only a limited portion drains into it. Direct rainfall into entrances is prevented either by the design of the entrance or by the construction of some form of weatherproof shelter above it. Baffle boards placed at the entrance floor are useful to keep out surface water.

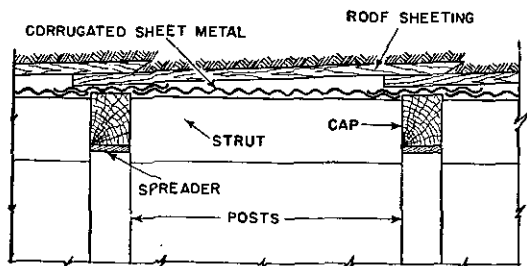

Figure. 69. Corrugated metal to waterproof shelter roof.

(2) **Seepage.** Protection against water seeping into shelters is important. In a surface or cut-and-cover shelter this is accomplished by placing tarpaper between the sheeting and the cover. In cave shelters a strip of corrugated iron may be placed on the cap of the frame (fig. 69). Sheeting is then driven over the iron. Space between caps is filled with an additional piece of corrugated iron supported by struts. Seepage is thus carried to the sides of the chamber, where it collects in a ditch leading to a sump.

(3) Removal of water from chambers and galleries. Galleries should be driven on a 1-percent (or 1 foot to 100 feet) grade longitudinally, and all slopes should fall toward a point or points where the water can be disposed of. If the shelter has a level entrance, regulate slopes so that water will run to the mouth. The gallery floor should slope laterally in a 1-percent grade and a ditch should be dug along one side. In a shelter entered by incline or shaft, a sump must be formed at the bottom from which water can be removed by pumping, siphoning, or bailing.

d. Ventilation. (1) Importance. Ventilation is a particularly important factor in cave shelters. It includes the following problems:

(a) Providing sufficient circulation of fresh air in the incline, shafts, galleries, and chamber.

(b) Gasproofing, or exclusion of gas from all parts of the shelter.

(c) Providing pure air by means of air purifiers (collective protectors) when the entrances and ventilation shafts are closed during a prolonged gas attack.

(2) Circulation of fresh air. (a) In surface and cut-and-cover shelters sufficient fresh air usually is obtained by keeping entrances open.

(b) In cave shelters ventilating shafts usually are necessary in addition to entrances. They are small vertical shafts, which may be bored from within after the completion of the shelter. A stovepipe through a shaft materially assists circulation of the air. In very large and elaborate systems of shelters a draft may be created by fans.

(c) A gallery should not be driven more than 60 feet without artificial ventilation. A gallery with a single opening is ventilated by forcing fresh air to the working end through a duct of wood, metal, or canvas. A pres-

sure blower worked by hand or power is an essential item of mining equipment. For excavations of moderate extent a portable forge forms an expedient ventilating device. Drill holes through the roofs of galleries promote ventilation. In a system of galleries having two or more outlets, air may be forced out from one outlet and drawn in through another. Screens or doors may be arranged to guide the distribution of fresh air. Vacuum operation is never as satisfactory as a pressure system.

(3) **Unventilated shelters.** Shelters not provided with collective protectors should be used only by personnel who are to remain inactive during occupancy. Since an inactive man requires about 1 cubic foot of air per minute, the capacity of unventilated shelters is limited in part by the difficulty of providing unusually large shelters. Initial air-space requirements for shelters for not over 12 men are 150 cubic feet per man. (See table III.)

TABLE III. *Capacities of unventilated shelters*

Type of shelter	Capacity (number of men)	Outside air below 90° F.		Outside air above 90° F.	
		Space (cubic feet per person) ¹		Space (cubic feet per person) ¹	
		Rest	Normal desk work	Rest	Normal desk work
Underground or above- ground walls of low heat conductivity. ²	10	200	360	240	500
	25	300	540	360	725
	50	400	750	500	1,000
Aboveground walls of high heat conductivity. ³	10	150	270	180	360
	25	235	425	270	540
	50	300	540	380	720

¹ Based on occupancy of 3 hours.

² Walls of wood on dry earth have low heat conductivity.

³ Walls of metal, concrete, masonry, and damp earth have high heat conductivity.

e. Terrains. Terrain should be considered with special reference to the effect of slope on the type of entrance and the rapidity with which overhead cover can be gained, and to the disposal of spoil.

70. GASPROOFING. a. General. It should be possible to make all shelters gastight. A shelter not in use should be sealed to exclude gas. Due to their low level, protected shelters are particularly subject to gas concentrations, and protection must be provided by curtains in entrances. During extended gas attacks men must be able to work and rest inside the shelter with gas masks off. This is of greatest importance in shelters where wounded are placed and, in shelters used for telephone central and signal stations, observation posts, headquarters, and other activities where the efficiency of the occupants would be considerably reduced by wearing gas masks.

b. Entrances. The standard M1 gasproof curtain is used to keep out gas. If it is not available, adjustable curtains may be made of blankets on light, sloping frames, built to fit snugly the individual entrance. Frames should be nailed securely to the sides and top of the entrance timbers. For cave shelters it is sometimes necessary to place gas curtains on the steps, but whenever possible they should be placed in horizontal entrances or horizontal approaches to inclines.

c. Other openings. Windows are covered with single curtains. All crevices should be caulked with clay, old clothes, or sandbags. Plugs, to be inserted during gas attacks, should be provided for periscope drainage, and ventilating openings. Flooring or steps in front of gas curtains should be kept clear of mud and refuse. Curtains should be kept moist with water or gasproof-

ing solutions. Fresh chloride of lime should be kept on hand and, when the area is gassed, should be placed between gas curtains at the entrance so that personnel entering the dugout may neutralize mustard and other persistent gases on hands and feet.

d. Air locks. Air locks are intermediate chambers between the outside and inside of shelters. They allow passage into the shelters, while excluding gas. Figure 70 shows a standard air lock suitable for most types of surface and cut-and-cover shelters; table IV shows the bill of materials for its construction. Where desirable, construction may be modified to provide greater headroom. Figure 71 shows an air lock used in first-aid shelters, designed to allow the passage of litters. It is adaptable to the shelters described in this chapter by increasing their height and width. Table V shows the bill of materials for its construction.

Curtain doors at each end of the air lock usually are constructed with standard M1 gasproof curtains. When an air lock's outer doorframe projects from the entrance, the curtain must be about 4 inches wider and 4 inches longer than the doorframe. If the air lock is built back into the entrance the curtain must be the same width as the doorframe. When not in use the curtain is rolled up and placed on top of the air lock or in a box-shelf above the top of the doorframe. (For details of the M1 gasproof curtain see TM 3-350.)

e. Collective protectors. (1) These devices are set up outside shelters to purify incoming air by removing chemical agents. Several types are designed to meet specific needs. Most collective protectors are driven by electric motors. Power is provided by a portable generator set, or taken from commercial sources when available. Connected directly with the motor is an air blower

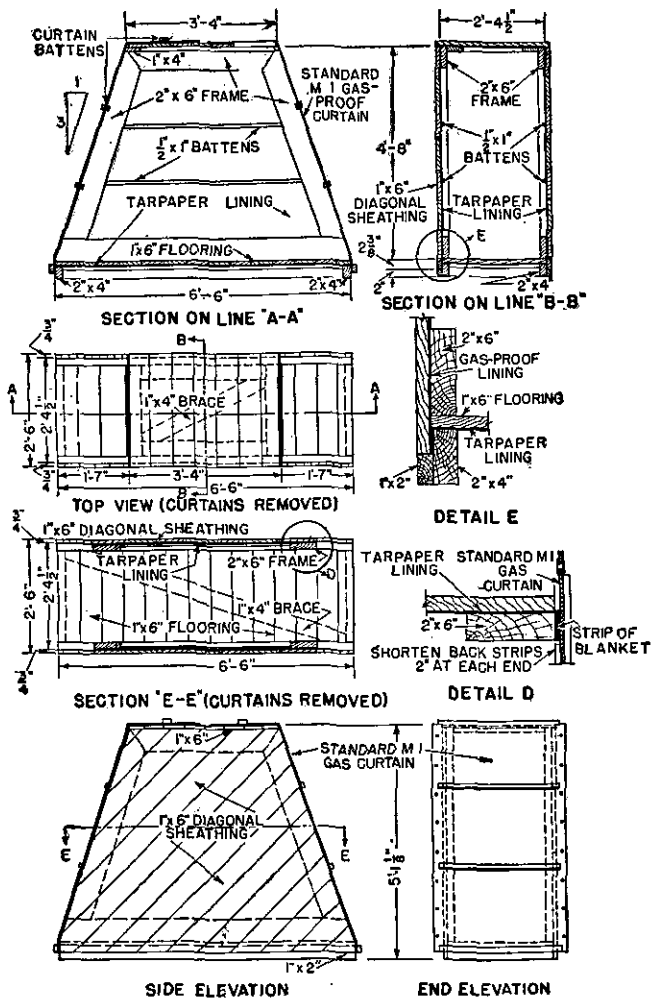
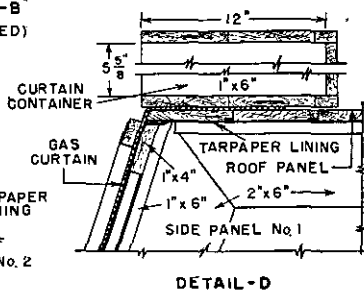
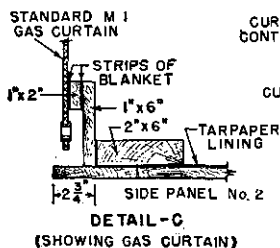
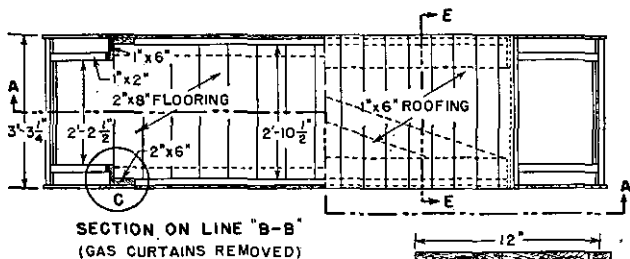
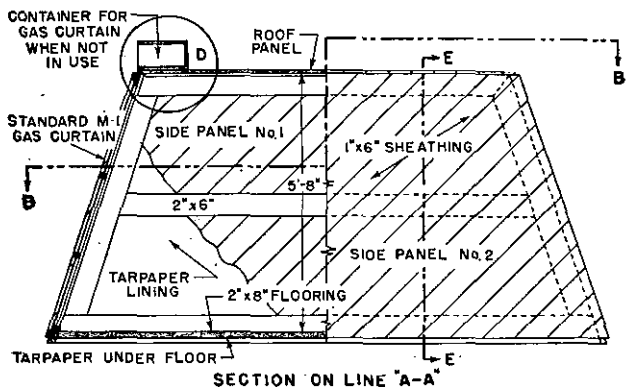

Figure 70. Standard air lock for shelter.

TABLE IV. Bill of materials for standard air lock (fig. 70)

Item	Size	Unit	Quantity	Weight (pounds)
Frame	2 by 6 inches by 12 feet	Each	4	192
Floor frame	2 by 4 inches by 10 feet	Each	2	55
Floor and sheathing	1 by 6 inches	Square feet	95	380
Bracing	1 by 4 inches by 12 feet	Each	2	32
Stop strip	1 by 2 inches by 14 feet	Each	1	.9
Gas curtains	M1	Each	2	29 (boxed)
Tarpaper	36 inches wide, 108 square feet area.	Roll	1	35
Nails	10d	Pound	5	5
Do	30d	Pound	2	2
Total weight				739



①

Figure 71. Air lock for first-aid shelter.

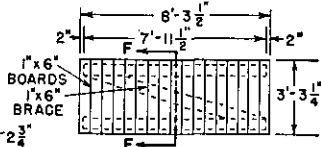
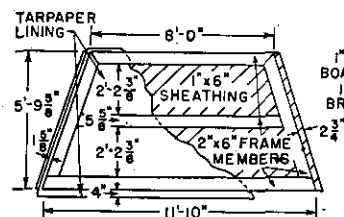
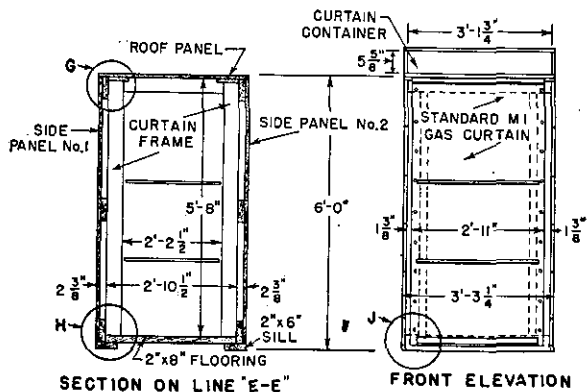

INSIDE VIEW OF SIDE PANEL No.1 (SIDE PANEL No.2 SAME-REVERSED)

TOP VIEW OF ROOF PANEL

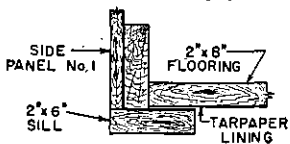
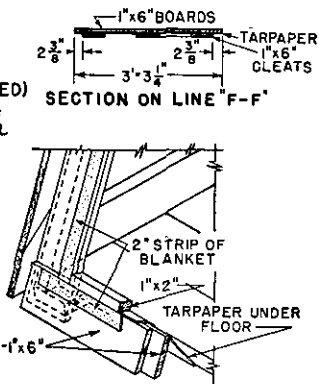
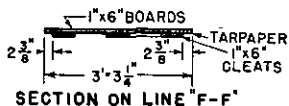

ISOMETRIC DETAIL OF J (GAS CURTAIN REMOVED)

②

Figure 71—Continued.

TABLE V. *Bill of materials for air lock for first-aid shelters (fig. 71)*

Item	Size	Unit	Quantity	Weight (pounds)
Floor	2 by 8 inches by 12 feet	Each	5	320
Sill	2 by 6 inches by 12 feet	Each	2	96
Frame	do.	Each	4	192
Do.	2 by 6 inches by 10 feet	Each	4	160
Sheathing, bracing, and cleats.	1 by 6 inches	Square feet	188	752
Curtain container	1 by 6 inches by 12 feet	Each	2	48
Curtain frame	do.	Each	4	96
Do.	1 by 2 inches by 12 feet	Each	2	16
Gas curtains	M1	Each	2	129
Tarpaper	36 inches wide, 108 square feet area.	Each	2	70
Nails	10d.	Pound	7	7
Do.	30d.	Pound	3	3
Total weight				1,789

¹ Bored

which draws outside air through a metal hose or pipe, forces it through a canister for purification, and thence into the shelter. Since concentration of gas invariably is greater near ground level, the air intake should be as high as practicable. The collective protector M1, which is a typical type, has a capacity of 200 cubic feet of air per minute under normal operating conditions.

(2) Collective protectors are obtained from the Chemical Warfare Service, and are installed in shelters intended to be used for a considerable time, such as shelters for command posts, resting troops, and first aid. Only shelters which have been made reasonably airtight should be equipped with collective protectors.

f. Sanitary conveniences. Sanitary conveniences should be provided in all but air-raid emergency shelters and surface type shelters. Disposal is by chemical closets, septic tanks, or drainage into special sewers.

71. OVERHEAD COVER. Figure 72 shows a typical overhead cover for protection against penetration and explosion of projectiles.

a. Bursting layer. The bursting layer covers the entire top of the shelter and extends beyond the top a distance equal to the depth of the shelter floor below the ground. The burster layer is made of standard bursters (fig. 73), standard reinforced concrete beams (fig. 74), rubble masonry, or poured concrete. Table VI shows required thickness of burster layers for different projectiles.

b. Distributing layers. The distributing layers tend to distribute the effects of explosion. The lowest distributing layer also bears the weight of the overhead

cover and transmits it to the berms of natural soil. The minimum length resting on the berm is equal to the thickness of the bottom cushion layer, plus 1 foot. Logs wired together, steel I-beams, rails, or concrete beams set on edge, are used in distributing layers.

c. Cushion layers. Cushion layers between bursting layers and distributing layers are made of sand,

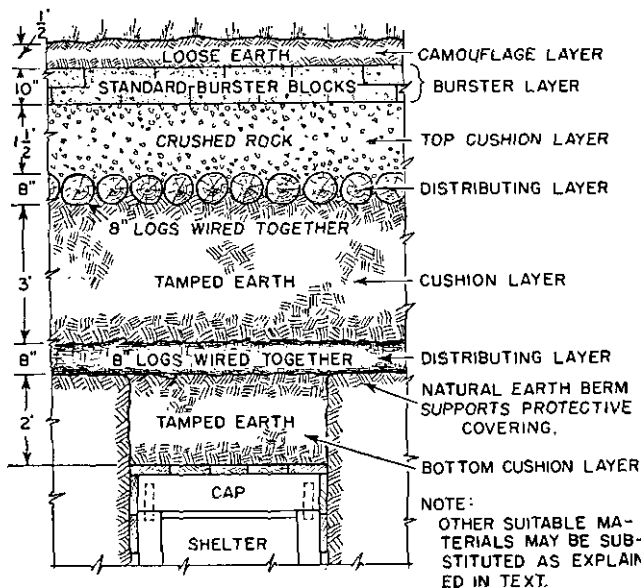
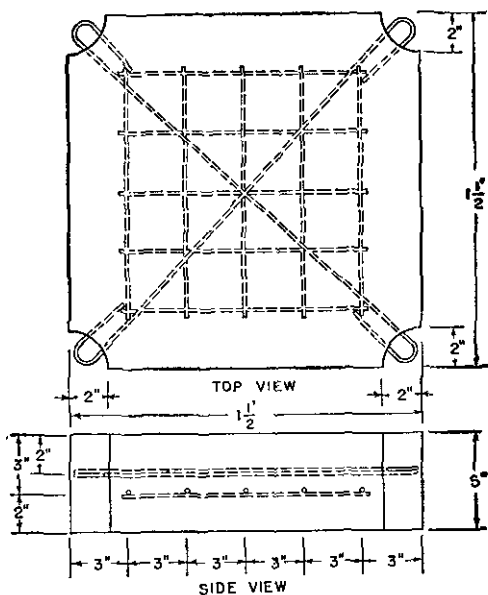

Figure 72. Typical overhead cover for cut-and-cover shelter.

gravel, tamped earth, crushed rock, or brick rubble. Preferably the top layer is of a granular material such as gravel or crushed rock, and the other layers are of tamped earth.



CONCRETE TO BE
 2000 LBS./SQ. IN. (MIN.)

WEIGHT 145 LB.
 19 FT. OF $\frac{3}{16}$ IN. DIA. ROD
 OR #6 WIRE

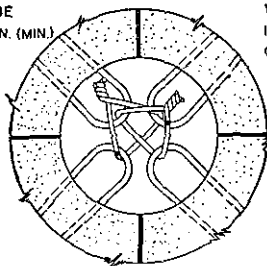

BURSTER ASSEMBLY

Figure 73. Standard burster block for burster layer.

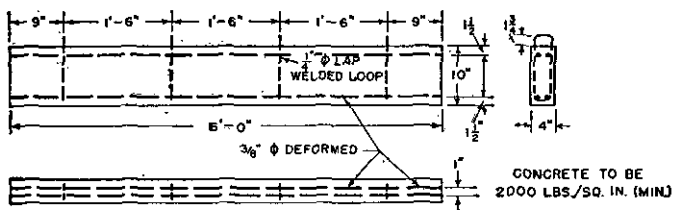

MADE IN LENGTHS OF 6, 12 AND 15 FT.
 WEIGHT 40 LBS PER FT.
 FOR 6'-0" BEAM-24 FT $\frac{3}{8}$ " ϕ ROD AND 9 FT $\frac{1}{4}$ " ϕ ROD
 FOR 12'-0" BEAM-48 FT $\frac{3}{8}$ " ϕ ROD AND 18 FT $\frac{1}{4}$ " ϕ ROD
 FOR 15'-0" BEAM-60 FT $\frac{3}{8}$ " ϕ ROD AND 22.5 FT $\frac{1}{4}$ " ϕ ROD

CONCRETE BEAM

Figure 74. Reinforced concrete beam for burster or distributing layers.

d. Example. The following is an example indicating the design of an overhead cover to provide protection against 105-mm projectiles (fig. 72). Materials available are: standard concrete bursters, logs (8-inch minimum diameter), crushed rock, and earth.

Assume a design as follows:

- 1 burster layer
 - 2 distributing layers
 - 3 intermediate layers
- (1) Total overhead cover required:
 From table XXII, 30 inches concrete.
- (2) Burster layer:
 From table VI, 10 inches of standard burster blocks are required, that is, two thicknesses.
 Equivalent thickness from table VI is 8 inches concrete.
- (3) Balance of overhead cover:
 Equivalent thickness is (1) minus (2) or 22 inches concrete.

TABLE VI. Minimum thickness of burster layer in inches

Material	Projectile			
	75-mm	105-mm	155-mm	100-pound GP bomb
Reinforced concrete slab (2,000 pounds per square inch minimum)-----	5	8	16	24
Standard reinforced concrete burster blocks or beams-----	5	10	20	30
Rubble masonry-----	8	12	24	36

(4) Distributing layers:

Use two layers of 8-inch logs, or total of 16 inches.

From table VII, equivalent thickness is $\frac{16}{2}$, or 8 inches concrete.

(5) Cushion layers:

Total equivalent thickness is (3) minus (4) or 14 inches concrete.

Use three layers, top layer to be granular material, that is, crushed rock, and other two layers to be tamped earth.

Bottom cushion layer should be approximately 2 feet thick, or, from table VII, the equivalent thickness is: $\frac{24}{7}$, or $3\frac{1}{2}$ inches concrete (approximate). This leaves the equivalent of 14 minus $3\frac{1}{2}$, or $10\frac{1}{2}$ inches of concrete to be divided between the remaining two cushion layers.

Middle cushion layer (tamped earth):

From table VII, $\frac{10.5}{2}$ times 7 equals 36 + inches or 3 feet (approximate).

Upper cushion layer (crushed rock) :

From table VII, $\frac{10.5}{2}$ times 3.5 equals 18 + inches, or 1½ feet (approximate).

TABLE VII. *Relative thickness of materials required to provide same overhead protection*

Material	Relative thickness
Reinforced concrete.....	1
Rubble masonry.....	1.5
Logs, 8-inch minimum diameter.....	2
Crushed stone or gravel.....	3.5
Tamped earth.....	7

72. STANDARD CONSTRUCTION MATERIALS.

a. General. Standard materials for construction of protected shelters are supplied by engineer agencies. Their use results in economy of material and labor, but they require transportation. In ordering these materials, if the size timber required is not available, a larger size may be substituted.

b. Timbers. Round timbers cut near the site often will be used in place of dimensioned lumber. Table VIII gives sawed timbers and equivalent round timbers.

TABLE VIII. *Equivalent timbers used as beams*

Sawed timbers (width by depth)	Area (square inches)	Equivalent round timber (diameter in inches)	Area (square inches)
1 by 4	4	3	7.1
1½ by 6	9	4½	15.9
2 by 4	8	4	12.6
2 by 6	12	5	19.6
2 by 8	16	6	28.3
2 by 10	20	7	38.5
3 by 3	9	3½	9.6
3 by 6	18	6	28.3
3 by 10	30	8	50.3
3 by 12	36	9	63.6
4 by 4	16	5	19.6
5 by 10	50	10	78.5
6 by 6	36	7	38.5
8 by 8	64	10	78.5
8 by 12	96	13	132.7
8 by 14	112	14	154.0
8 by 16	128	15	177.0
12 by 12	144	14	154.0

NOTE. The equivalent round timbers are also safe as columns. In making up the table, primary consideration was given to resistance to bending. However, in every case the round timber will resist more vertical shear than the timber of rectangular cross section to which it is equivalent.

c. Corrugated steel arches. Arches are made from heavy corrugated steel. Figures 75, 76, and 77 show details of standard types. The gauge of the corrugated metal sheets will vary with the type of overhead cover to be supported.

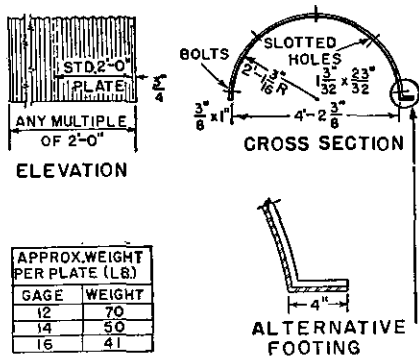

Figure 75. Corrugated metal arch for two-man shelter.

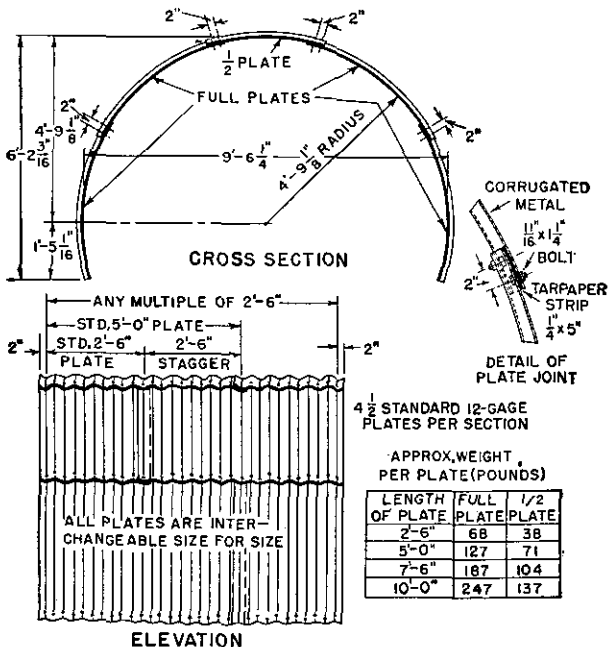

Figure 76. Semicircular corrugated metal arch for shelter.

d. Gallery and shaft cases. Cases are designed as linings, without additional material except battens for use in horizontal galleries, inclined passages, and shafts driven under ground by mining methods. Cases also

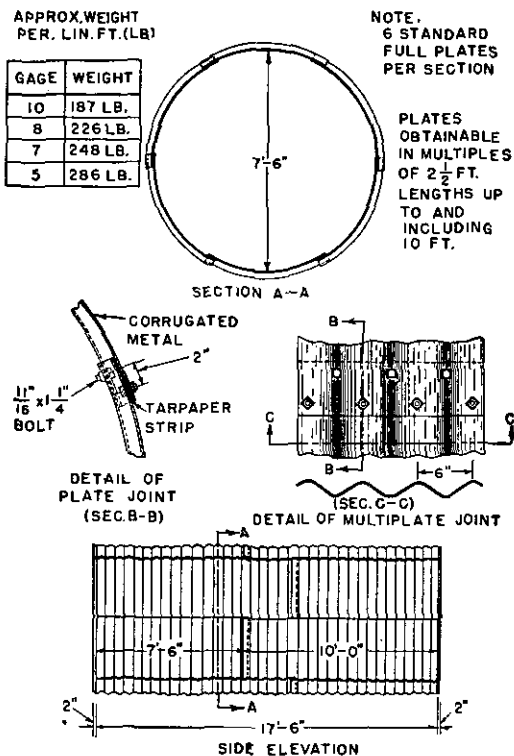

Figure 77. Circular corrugated metal arch for shelter.

may be used in constructing entrances to cut-and-cover shelters. Note that frames in e below require sheeting in addition. Dimensions of lumber used in cases vary with the size of gallery or shaft (table IX). The

standard common gallery case, using dimensioned lumber and round timbers, and the improvised shaft case using round timbers, are shown in figures 78 and 79.

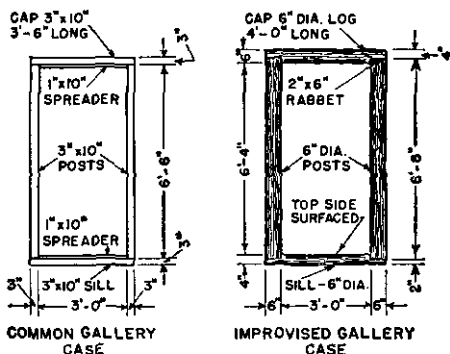

Figure 78. Gallery cases for cave shelters.

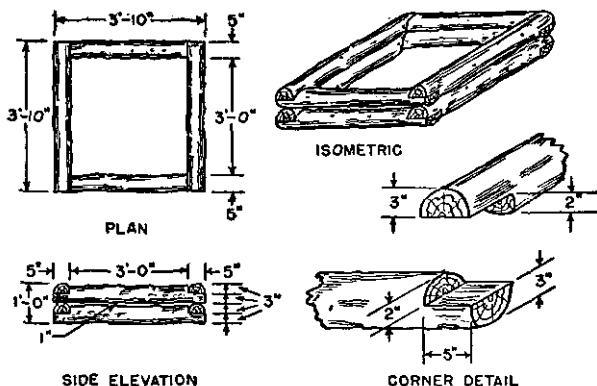

Figure 79. Improved shaft case for cave shelters.

e. Chamber, gallery, and shaft frames. (1) Standard frames are shown in figure 80. They are used in horizontal or inclined passages, or in shafts, to support sheeting. In shafts, all timbers of a frame are the same size as frame posts. The dimensions permit frame

spacing not over 4 feet on centers. Frames can be improvised from round timber.

(2) The chamber frame is used in rooms or chambers of cave shelters. The posts may be 6- by 6-inch timber, or round straight logs at least 6 inches in diameter at the small end, and as free as possible from knots. Caps are 6- by 10-inch timber.

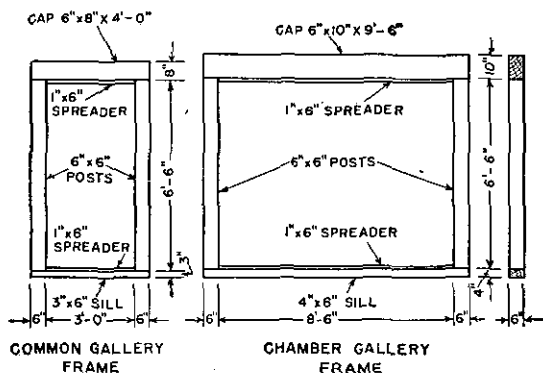

Figure 80. Standard frames for cave shelters.

f. Dimensions of standard galleries and shafts.

Tables IX, X, and XI give sizes of various classes of galleries and shafts driven by mining methods, and include bills of material.

TABLE IX. *Dimensions of standard timbered galleries*

Size of gallery	Inside, clear	
	Height	Width
Chamber.....	6 feet 4 inches.....	8 feet 6 inches.
Great.....	6 feet 4 inches.....	6 feet 6 inches.
Common.....	6 feet 4 inches.....	3 feet 0 inches.
Half.....	4 feet 6 inches.....	3 feet 0 inches.
Branch.....	2 feet 10 inches.....	3 feet 0 inches.
Small branch.....	2 feet 4 inches.....	1 foot 10 inches.

TABLE X. *Bill of materials for gallery and shaft cases*

Item	Great	Common	Half	Branch	Small branch
Cap	One 4 by 10 by 7 ft. 2 in.	One 3 by 10 by 3 ft. 6 in.	One 3 by 10 by 3 ft. 6 in.	One 3 by 10 by 3 ft. 6 in.	One 2 by 10 by 2 ft. 4 in.
Sill	One 3 by 10 by 7 ft. 2 in.	One 3 by 10 by 3 ft. 6 in.	One 3 by 10 by 3 ft. 6 in.	One 3 by 10 by 3 ft. 6 in.	One 2 by 10 by 2 ft. 4 in.
Post	Two 4 by 10 by 6 ft. 6 in.	Two 3 by 10 by 6 ft. 6 in.	Two 3 by 10 by 4 ft. 8 in.	Two 3 by 10 by 3 ft. 0 in.	Two 2 by 10 by 2 ft. 6 in.
Spreader	Two 1 by 10 by 6 ft. 6 in.	Two 1 by 10 by 3 ft. 0 in.	Two 1 by 10 by 3 ft. 0 in.	Two 1 by 10 by 3 ft. 0 in.	Two 1 by 10 by 2 ft. 0 in.
Nails (spread- ers only).	0.25 pound (10d).	0.25 pound (10d).	0.25 pound (10d).	0.25 pound (10d).	0.25 pound (10d).
Total weight (lbs.).	385	220	180	150	75.

TABLE XI. *Bill of material for gallery and shaft frames*

Item	Chamber gallery frame	Great gallery frame	Common gallery frame	Half gallery frame	Branch gallery frame	Small gallery frame
Cap	One 6 by 10 by 9 ft. 6 in.	One 6 by 8 by 7 ft. 6 in.	One 6 by 8 by 4 ft. 0 in.	One 6 by 6 by 4 ft. 0 in.	One 4 by 6 by 3 ft. 8 in.	One 4 by 4 by 2 ft. 6 in.
Sill	One 4 by 6 by 9 ft. 6 in.	One 4 by 6 by 7 ft. 6 in.	One 3 by 6 by 4 ft. 0 in.	One 3 by 6 by 4 ft. 0 in.	One 2 by 4 by 3 ft. 8 in.	One 2 by 4 by 2 ft. 6 in.
Post	Two 6 by 6 by 6 ft. 6 in.	Two 6 by 6 by 6 ft. 6 in.	Two 6 by 6 by 6 ft. 6 in.	Two 6 by 6 by 4 ft. 8 in.	Two 4 by 4 by 3 ft. 0 in.	Two 4 by 4 by 2 ft. 6 in.
Spreader	Two 1 by 6 by 8 ft. 6 in.	Two 1 by 6 by 6 ft. 6 in.	Two 1 by 6 by 3 ft. 0 in.	Two 1 by 6 by 3 ft. 0 in.	Two 1 by 4 by 3 ft. 0 in.	Two 1 by 4 by 2 ft. 0 in.
Nails (spreader only).	0.4 pound (10d).	0.4 pound (10d).	0.2 pound (10d).	0.2 pound (10d).	0.2 pound (10d).	0.2 pound (10d).
Total weight (lbs.).	470	360	256	195	80	50.

g. Standard sheeting. Sheeting supports the earth in chambers and galleries, and in inclines and shafts where frames rather than cases are used. Two-inch sheeting is furnished for the roof, and 1½-inch or 2-inch sheeting for the sides. Normally, it is in 5-foot lengths where frame spacing is not over 4 feet on centers, and in 4-foot lengths where frame spacing is not over 3 feet on centers. It varies from 4 to 10 inches in width. Side sheeting is used for headboards and stair-risers, which are 1½ by 10 inches by 3 feet 6 inches in stepped inclines. Where ground conditions are favorable, round poles, 2½ inches in diameter at the butt and 4 to 5 feet long, may be substituted.

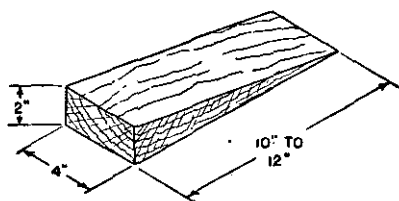

NOTE:
CUT FROM 2" x 4"
LUMBER.

Figure 81. Wedge for driving sheeting.

h. Wedges are used in driving galleries and shafts and also to brace timbers tightly against the walls and roofs of the excavation, holding them in place during settling. Dimensions of a common-type wedge are shown in figure 81. Other sizes may be used as needed.

i. Bunk posts. Bunk posts, 4 by 4 inches and 2 by 4 inches, respectively, support the double tier of bunks in shelters. The 4 by 4's should be placed under the caps of the frames for additional support. Round timber, 4 inches in diameter at the small end, may be substituted.

j. Use of lumber. Commercial lumber is used for items such as props, bunks, gas curtain frames, battens for holding timbers in place during construction, strapping together incline and shaft cases, and making bomb recesses and baffle boards. Scrap lumber is used with wedges for blocking timbers in place.

k. Tools. Common tools include pick, shovel, crowbar, pickmattock, sledge, hammer, saw, maul, ax, adz, tape, level, plumb line, pliers, and wire cutters. Special tools, such as the air compressor or earth-moving equipment, may be of great help.

SECTION II

SURFACE SHELTERS

73. GENERAL. **a.** Surface shelters generally are constructed of local materials, such as lumber from demolished houses or cut logs covered with earth. Corrugated metal also is employed. They are usually built for temporary use, or as expedients when the construction of more protective types is restricted by unfavorable conditions of ground soil or water. They are of small capacity, well dispersed, and carefully concealed.

b. Most surface shelters give protection only against effects of blast, splinters, and gas. They are unsuitable in areas subject to continual bombardment, and are erected in advanced positions only when they can be well concealed in woods or among existing buildings, or sited on steep reverse slopes. They are usually

occupied by troops seeking shelter from enemy bombardment or gas attacks.

c. This type of shelter is especially suitable in mobile warfare when the details of a position are not known to the enemy. As the enemy becomes acquainted with the dispositions, shelters furnishing more protection are required.

74. TYPES OF CONSTRUCTION: a. **Wood shelters.** Wood shelters protect personnel against blast, splinters, and gas attacks of short duration. They can be extended lengthwise to increase capacity. Baffle walls divide shelters into compartments. Figure 82 shows details of one type of shelter that gives protection against blast and splinters. The bill of materials for it appears in table XII.

b. **Metal shelters.** Metal shelters are superior to wood shelters because they are erected more rapidly, require less outside cover, present smaller targets, and give greater protection from weather; also, the shelter's arch section gives greater resistance to blast, earth shock, and movement. The disadvantages are the use of a critical material and the transportation of the material to the site. The most satisfactory type to build is circular, sunk one-third its height into the ground, and covered with excavated material (fig. 83). In this type the vertical surface exposed to blast is reduced, and the earth movement resulting from an underground explosion tends to lift the entire shelter, exerting little destructive force. Figures 83 and 84 show corrugated metal shelters which afford protection against blast and splinters. Tables XIII and XIV show bills of materials for construction.

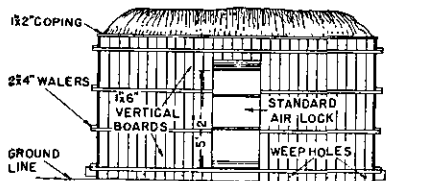
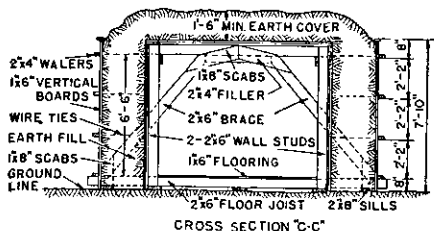

FRONT ELEVATION

NOTE:
4 WIRE TIES
PER STUD ALL
AROUND.

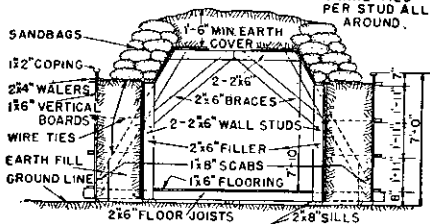

CROSS SECTION SHOWING
ALTERNATIVE CONSTRUCTION

①

Figure 82. Surface shelter constructed of wood and utilizing earth blast wall.

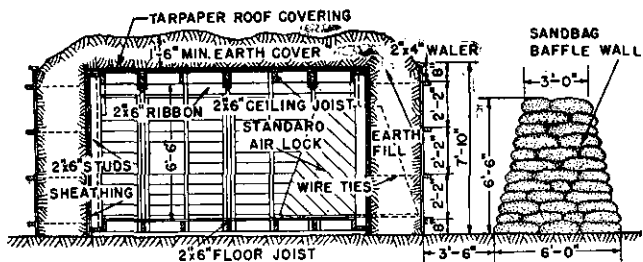

LONGITUDINAL SECTION "A-A"

WALLS AND ROOF OF SHELTER TO HAVE TWO THICKNESSES OF 1 1/2" SHEATHING. FIRST LAYER TO BE APPLIED HORIZONTALLY AND SECOND LAYER DIAGONALLY. TARPAPER OVER.

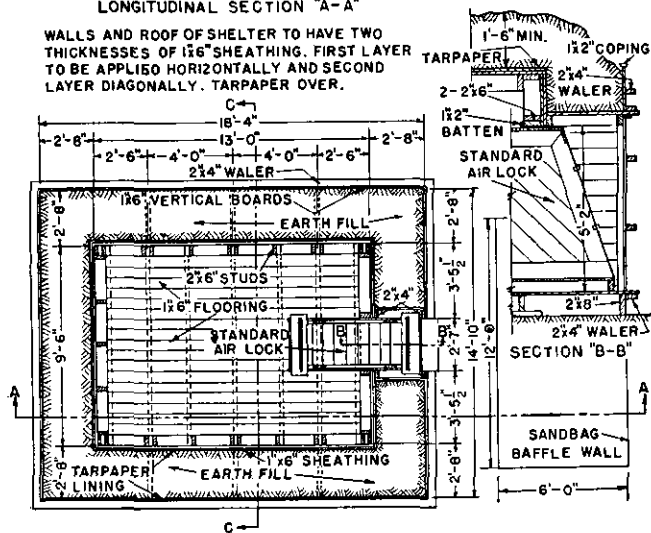

PLAN

(2)

Figure 82—Continued.

TABLE XII. Bill of materials for surface wood shelter (fig. 82)

Item	Size	Unit	Quantity	Weight (pounds)
Sills	2 by 8 inches by 14 feet	Each	5	372
Floor joists, ceiling joists, caps, and sills.	2 by 6 inches by 10 feet	Each	15	600
Frame floor joists	2 by 6 inches by 16 feet	Each	3	192
Studs	2 by 6 inches by 8 feet	Each	33	1,056
Bracing	2 by 6 inches by 10 feet	Each	6	240
Ribbons	2 by 6 inches by 12 feet	Each	2	96
Walers and fillers	2 by 4 inches by 20 feet	Each	16	853
Floor and sheathing	1 by 6 inches	Square feet	2,050	8,200
Coping and battens	1 by 2 inches by 10 feet	Each	11	73
Nails	10d	Pound	66	66
Do	30d	Pound	15	15
Wire, galvanized	10-gauge	Linear foot	220	4
Tarpaper	36 inches wide, 108 square feet area.	Roll	12	420
Sandbags	Standard	Each	756	378
Air lock	do	Each	1	739
Total weight				13,304

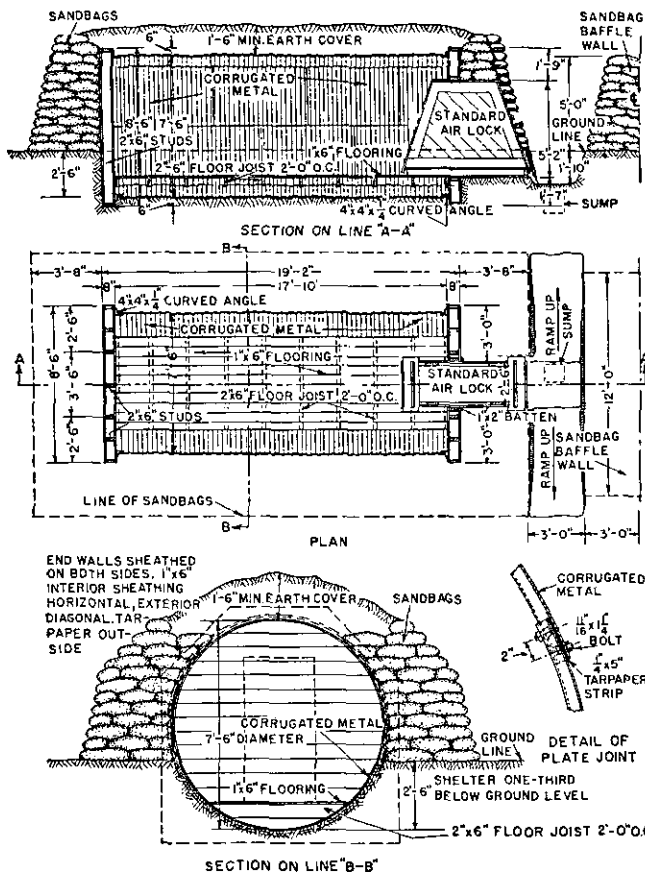

Figure 83. Surface shelter constructed of a circular section of corrugated metal and utilizing sandbag blast wall.

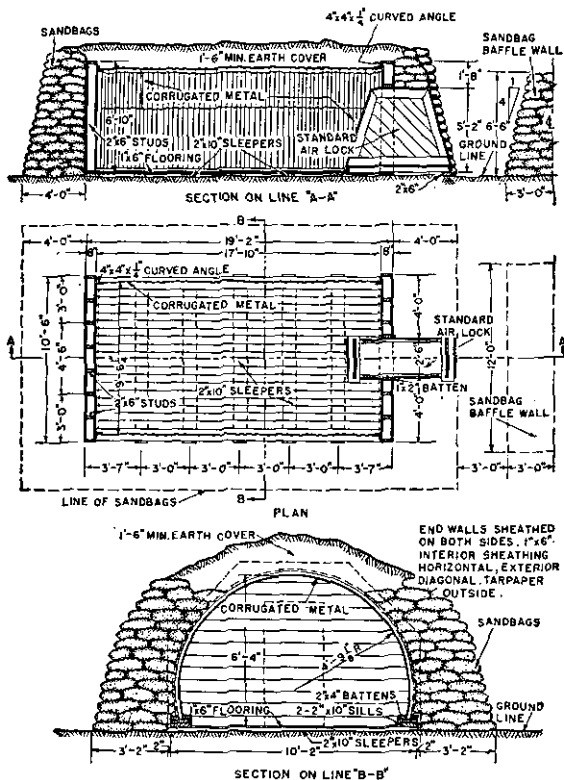

Figure 84. Surface shelter constructed of semicircular section of corrugated metal and utilizing sandbag blast wall.

TABLE XIII. Bill of materials for circular surface corrugated metal shelter (fig. 83)

Item	Size	Unit	Quantity	Weight (pounds)
Corrugated metal with nuts and bolts.	} Standard 10-gauge	{ 7½-foot plate	6	} 3, 280
Floor joist		{ 10-foot plate	6	
End frames	2 by 6 inches by 10 feet	Each	5	200
Floor	2 by 6 inches by 12 feet	Each	14	672
Sheathing	1 by 6 inches	Square foot	100	400
Tarpaper	do.	Square foot	260	1, 040
	36 inches wide, 108 square feet area.	Roll	2	70
Curved angle	4 by 4 by ¼ inches by 24 feet	Each	2	310
Nails	10d.	Pound	18	18
Sandbags	Standard	Each	2, 500	1, 250
Air lock	do.	Each	1	739
Total weight				7, 979

NOTE. Above quantities, other than sandbags, apply also to the cut-and-cover corrugated metal shelter shown in figure 89.

TABLE XIV. Bill of materials for surface, semicircular, corrugated metal shelter (fig. 84)

Item	Size	Unit	Quantity	Weight (pounds)
Corrugated metal with nuts and bolts.	Standard	10-foot plate	4½	1, 977
		7½-foot plate	4	
Sleepers	2 by 10 inches by 18 feet	Each	4	480
Sills	2 by 10 inches by 12 feet	Each	7	560
Studs, caps, and sills	2 by 6 inches by 12 feet	Each	13	624
Battens	2 by 4 inches by 18 feet	Each	4	192
Floor and end frame sheathing.	1 by 6 inches	Square foot	500	2, 000
Curved angle	4 by 4 by ¼ inch by 18 feet	Each	2	240
Sandbags	Standard	Each	4, 050	2, 025
Tarpaper	36 inches wide, 108 square feet area.	Roll	2	70
Air lock	Standard	Each	1	739
Nails	10d.	Pound	11	11
Do	30d.	Pound	4	4
Total weight				8, 922

SECTION III

CUT-AND-COVER SHELTERS

75. GENERAL. a. Cut-and-cover shelters are the most common type in combat zones. The shelter is constructed in an open excavation, and spoil is back-filled around and over it to the ground level or somewhat above. It is built of local material, sized lumber or timber, or corrugated metal. The protection afforded depends on the type of construction and the overhead cover. (See par. 71.)

b. This type of shelter is used to protect personnel, supplies, and matériel. It is especially suitable for command posts and first-aid or dressing stations, since it is easily cleaned and ventilated and admittance and evacuation of casualties can be easily accomplished.

c. For drainage the floors of the shelter slope slightly toward the entrance. Excavation should be no greater than necessary to accommodate the shelter, and dirt should be packed tightly around the frame.

76. TYPES OF CONSTRUCTION. a. **Wood shelters.** Wood shelters generally are built without floors. Figure 85 and table XV describe a cut-and-cover shelter built with dimensional lumber. Figure 86 and table XVI describe the same type of shelter, using logs. This type gives blastproof and splinterproof protection. The thickness of overhead cover should not be increased unless a heavier type construction is used. Figure 87 and table XVII describe a two-man shelter of wood, built with branch gallery cases.

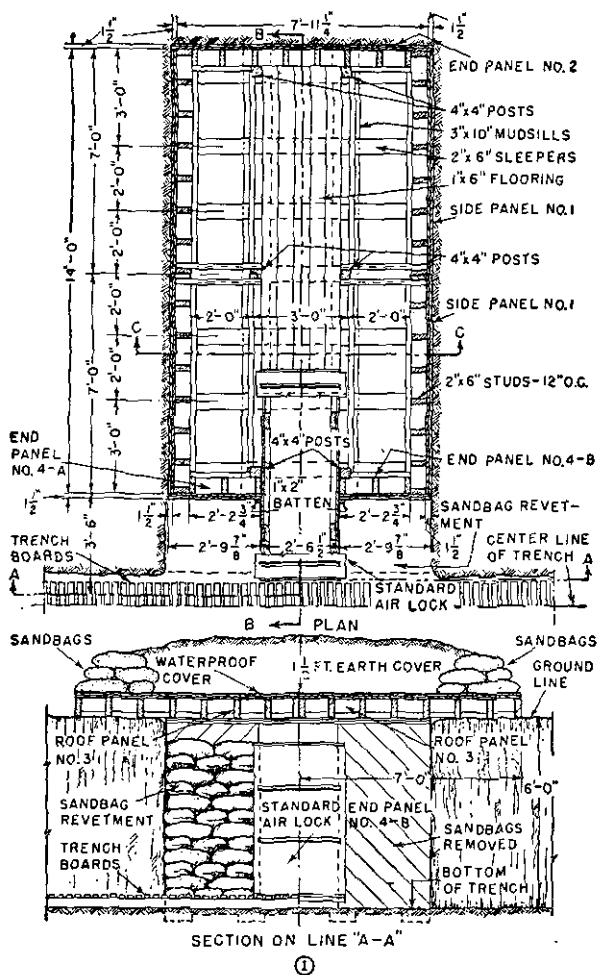
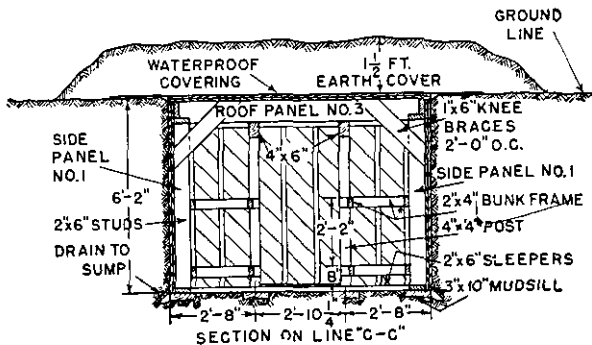
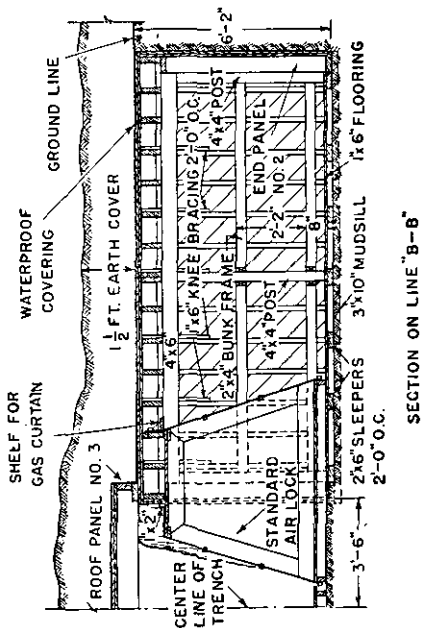
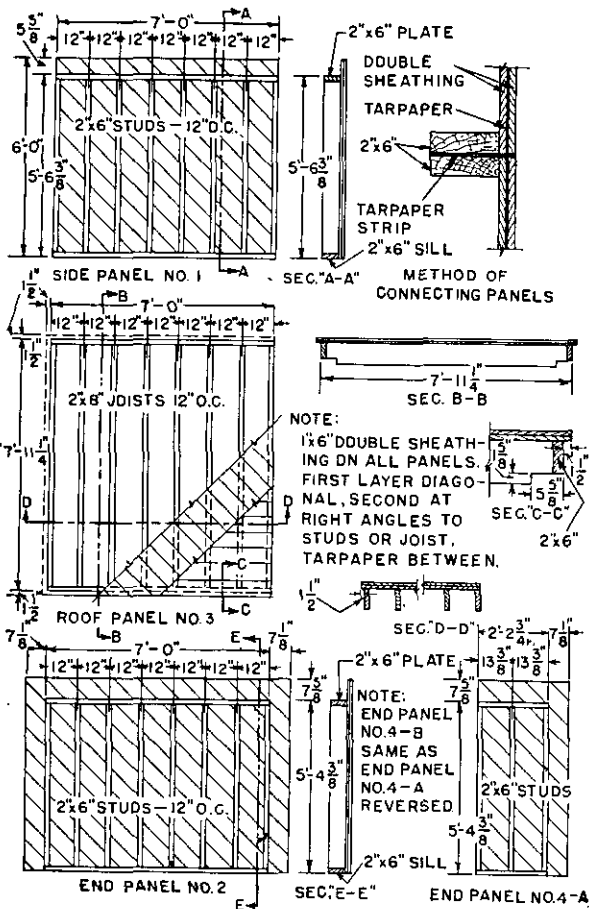

Figure 85. Cut-and-cover shelter constructed of dimensional lumber.



(2)

Figure 85—Continued.



(3)

Figure 85—Continued.

TABLE XV. Bill of materials for cut-and-cover shelter constructed of dimensional lumber (fig. 85)

Item	Size	Unit	Quantity	Weight (pounds)
Caps	4 by 6 inches by 14 feet	Each	2	224
Posts	4 by 4 inches by 10 feet	Each	3	160
Mud sill	3 by 10 inches by 16 feet	Each	4	640
Roof joists	2 by 8 inches by 8 feet	Each	16	684
Sleepers	2 by 6 inches by 14 feet	Each	4	224
Studs	2 by 6 inches by 12 feet	Each	23	1, 104
Plates and sills	2 by 6 inches by 14 feet	Each	6	336
Headers, roof frame	do	Each	2	112
Bunk frame	2 by 4 inches by 12 feet	Each	12	384
Floor	1 by 6 inches	Square feet	41	164
Sheathing	do	Square feet	900	3, 600
Knee bracing	1 by 6 inches by 12 feet	Each	3	72
Tarpaper	36 inches wide, 108 square feet area	Roll	5	175
Air lock	Standard	Each	1	739
Roofing nails	10-gauge, 1 inch long	Pound	2	2
Nails	10d	Pound	33	33
Do	30d	Pound	6	6
Staples, bunk	7/8-inch, No. 9	Pound	4	4
Sandbags	Standard	Each	160	80
Wire, galvanized, bunk	10-gauge	Linear feet	165	6
Wire, netting, bunk	72 inches wide, 2-inch mesh	Linear feet	36	18
Total weight				8, 767

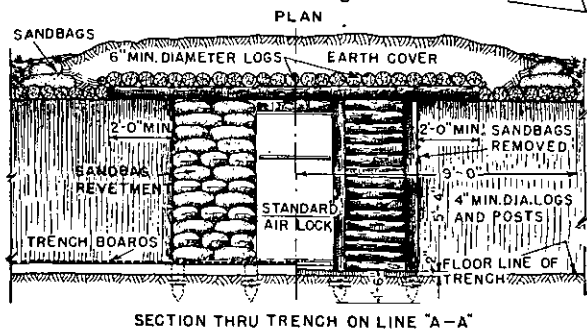
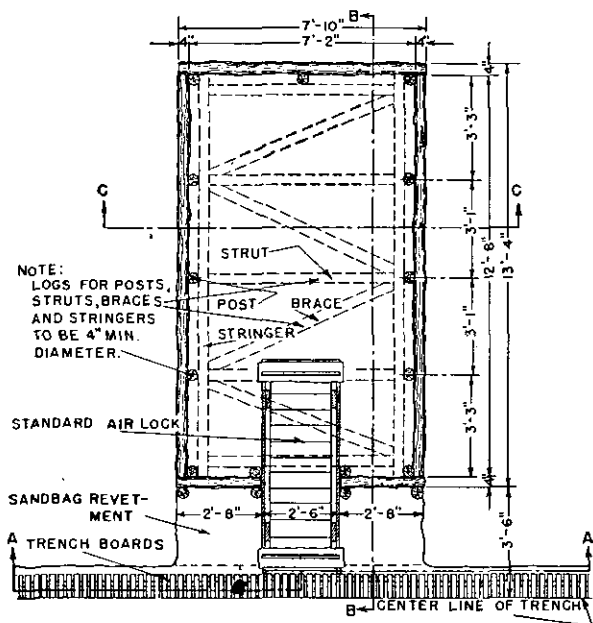

①

Figure 86. Cut-and-cover shelter constructed of logs.

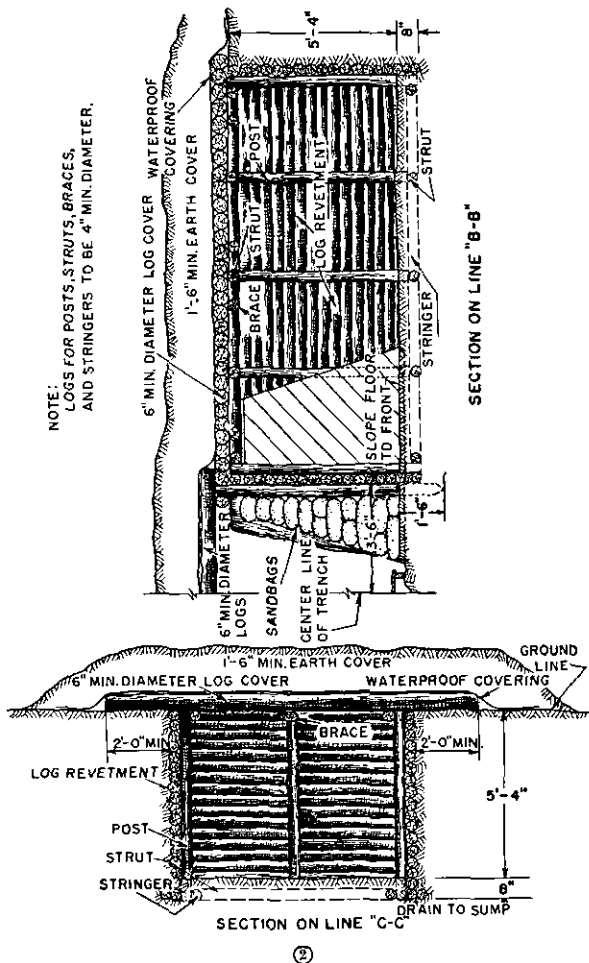
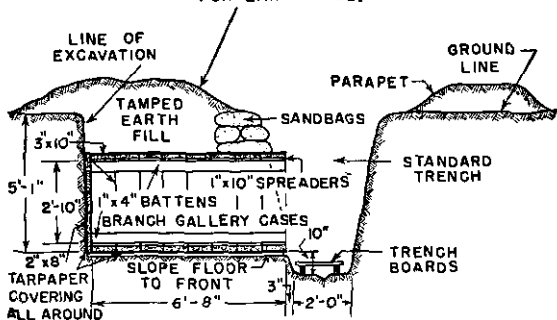

Figure 86—Continued.

TABLE XVI. Bill of materials for cut-and-cover log shelter (fig. 86)

Item	Size	Unit	Quantity
Struts, floor and roof	4 inches minimum diameter by 5 feet 10 inches	Each	10
Stringers, floor and roof	4 inches minimum diameter by 12 feet 8 inches	Each	4
Bracing, roof, to cut	4 inches minimum diameter by 6 feet 6 inches	Each	4
Posts, frame only	4 inches minimum diameter by 6 feet 0 inch	Each	13
Posts, face of shelter	4 inches minimum diameter by 7 feet 4 inches	Each	4
Walls, side	4 inches minimum diameter by 12 feet 8 inches	Each	34
Wall, end	4 inches minimum diameter by 7 feet 10 inches	Each	18
Wall, front	4 inches minimum diameter by 2 feet 8 inches	Each	36
Roof	6 inches minimum diameter by 12 feet 0 inch	Each	30
Air lock	Standard	Each	1
Roofing nails	10 gauge, 1 inch long	Pound	1
Nails	60d	Each	75
Tarpaper	36 inches wide, 108 square feet area	Roll	6
Sandbags	Standard	Each	150

FOR GREATER OVERHEAD PROTECTION A MORE RESISTANT MATERIAL MAY BE SUBSTITUTED FOR EARTH FILL.



LONGITUDINAL SECTION

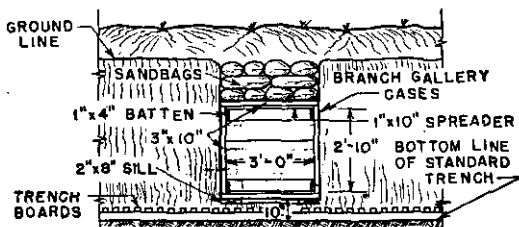

FRONT ELEVATION

Figure 87. Two-man cut and cover shelter constructed of branch gallery cases.

TABLE XVII. *Bill of materials for two-man, wooden shelter (fig. 87)*

Item	Size	Unit	Quantity	Weight (pounds)
Gallery cases	Branch	Each	8	1, 200
Back wall and sills	2 by 8 inches by 14 feet	Each	3	224
Battens	1 by 4 inches by 14 feet	Each	2	37
Nails	10d	Pound	3	3
Do	30d	Pound	3	3
Sandbags	Standard	Each	16	8
Tarpaper	36 inches wide, 108 square feet area.	Roll	1	35
Total weight				1, 510

b. Metal shelters. Metal shelters are quickly and easily constructed, are blastproof and splinter-proof, and give the greatest protection against water and earth shock. Flooring is necessary. Figures 88 and 89 and tables XIII and XVIII describe types of corrugated

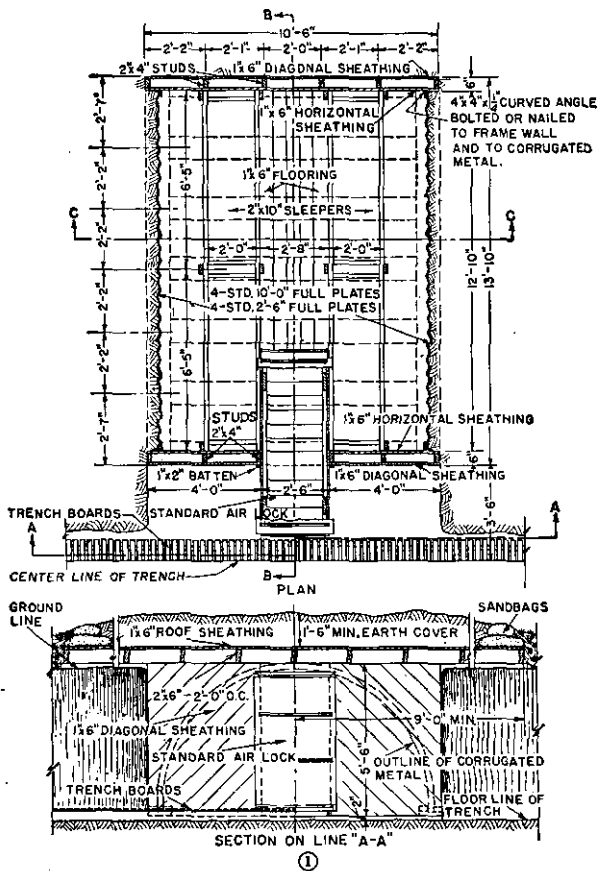
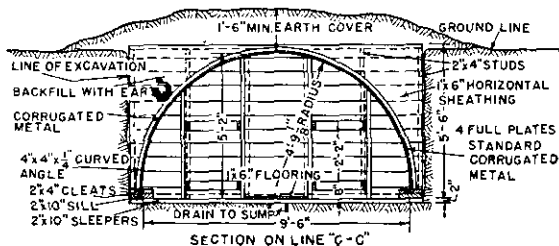
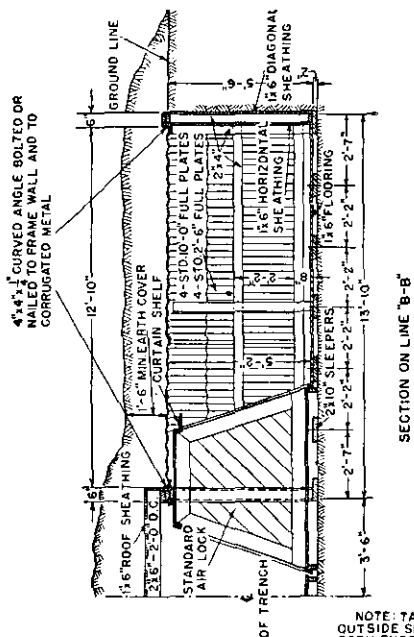

Figure 88. Cut-and-cover shelter constructed of semicircular corrugated metal arches.



(2)

Figure 88—Continued.

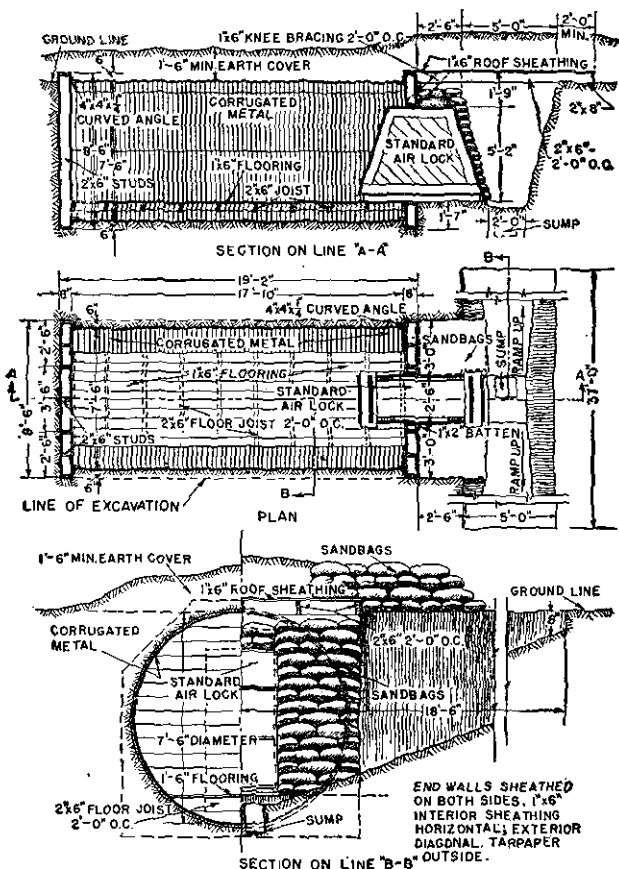

Figure 89. Cut-and-cover shelter constructed of circular corrugated metal arches.

TABLE XVIII. Bill of materials for semicircular, cut-and-cover, corrugated metal shelter (fig. 88)

Item	Size	Unit	Quantity	Weight (pounds)
Corrugated metal with nuts and bolts.	} Standard	{ 2½-foot plate	4	1, 260
Sills				
Sleepers	2 by 10 inches by 14 feet	Each	4	187
Studs, caps, and sills	2 by 10 inches by 12 feet	Each	2	560
Cicats	2 by 4 inches by 12 feet	Each	7	320
Bunk frames	2 by 4 inches by 14 feet	Each	10	149
Floor and sheathing	do.	Each	4	523
Curved angle	1 by 6 inches	Square foot	14	1, 220
	4 by 4 by ¼ inch by 15 feet 4 inches.	Each	305	204
Tarpaper	36 inches wide, 108 square feet area.	Roll	2	70
Nails	10d	Pound	17	17
Do	30d	Pound	6	6
Air lock	Standard	Each	1	739
Staples, bunk	7/8-inch, No. 9	Pound	5	5
Wire, galvanized, bunk	10-gauge	Linear foot	190	6
Wire netting, bunk	72 inches wide, 2-inch mesh	Linear foot	33	17
Total weight				5, 283

metal shelters. These provide blastproof and splinter-proof protection. Figure 90 and table XIX describe a two-man shelter of corrugated metal which may be

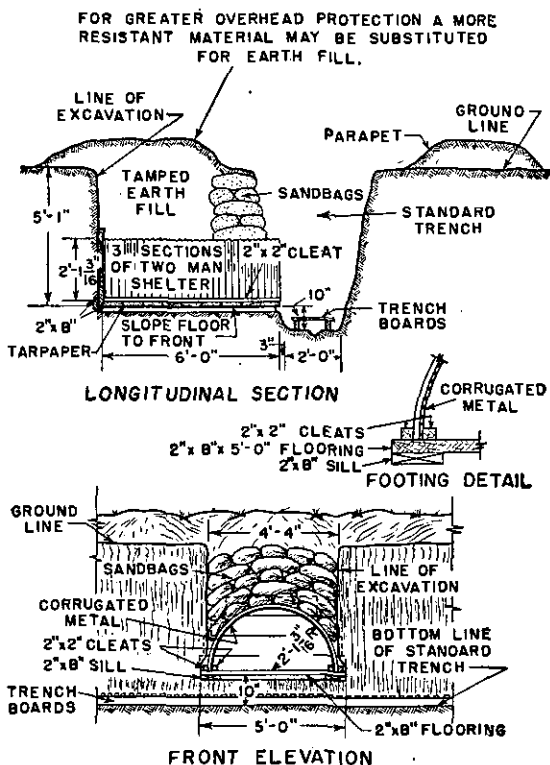

Figure 90. Two-man cut-and-cover shelter constructed of corrugated metal arches.

either cut-and-cover construction in loose soil, or cave type in firm soil.

TABLE XIX. *Bill of material for two-man corrugated metal shelter (fig. 90)*

Item	Size	Unit	Quantity	Weight (pounds)
Corrugated arches with nuts and bolts.	Two-man, 16-gauge	2-foot sections	3	123
Sills, floor, and backboard	2 by 8 inches by 10 feet	Each	8	423
Cleats	2 by 2 inches by 12 feet	Each	2	32
Sandbags	Standard	Each	32	16
Tarpaper	36 inches wide, 108 square foot area.	Roll	1	35
Nails	10d	Pound	2	2
Do	30d	Pound	2	2
Total weight				633

c. Gallery frames or cases. By heavy construction, similar to that required for cave shelters with standard gallery frames or cases (par. 72), light-shellproof and even shellproof cut-and-cover shelters can be constructed. Such shelters are, in effect, cave shelters constructed by cut-and-cover methods. Overhead cover is provided as outlined in paragraph 71.

SECTION IV

CAVE SHELTERS

77. GENERAL. **a.** Cave shelters normally are built in rear areas. They take longer to build than other types but, when time is available for construction, are preferable to other shelters because they give maximum protection.

b. An accurate estimation of the necessary protection is essential for economical construction, since it determines the depth of the chamber. A too-shallow chamber site gives too little protection, or else requires difficult and uneconomical later operations to deepen it. A chamber set too deep wastes labor, time, and materials. Frequently in hilly terrain a tunnel dug into the side of a hill may serve as a cave shelter, thus eliminating the need for shafts and inclined entrances.

c. Most cave shelters are in earth. Construction in rock is unusual except in certain types of permanent fortifications.

d. Standard methods and materials simplify and expedite construction. A consolidated bill of materials

for a cave shelter built of standard parts may be made up from the bill of materials in tables XX and XXI.

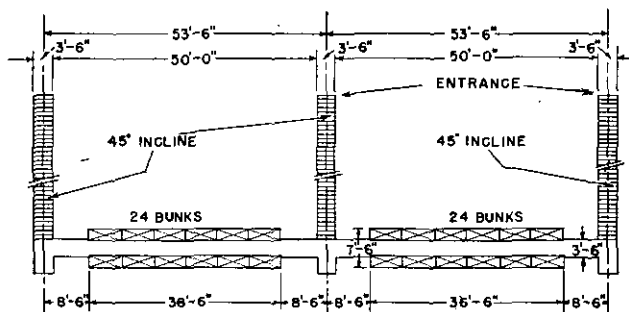

GALLERY TYPE

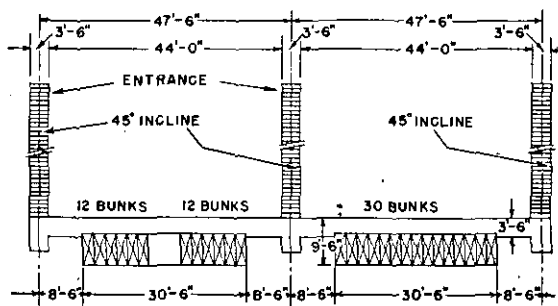

RECESS TYPE

Figure 91. Schematic lay-out of gallery and recess cave shelters showing entrances and inclines leading down to shelter.

These tables list the materials required to construct gallery or recess chambers, passages, grenade pits, inclines, and air locks.

78. TYPES. Examples of cave shelters for various purposes are:

a. Infantry cave shelters (personnel). Figure 91 shows the standard arrangement of both recess and

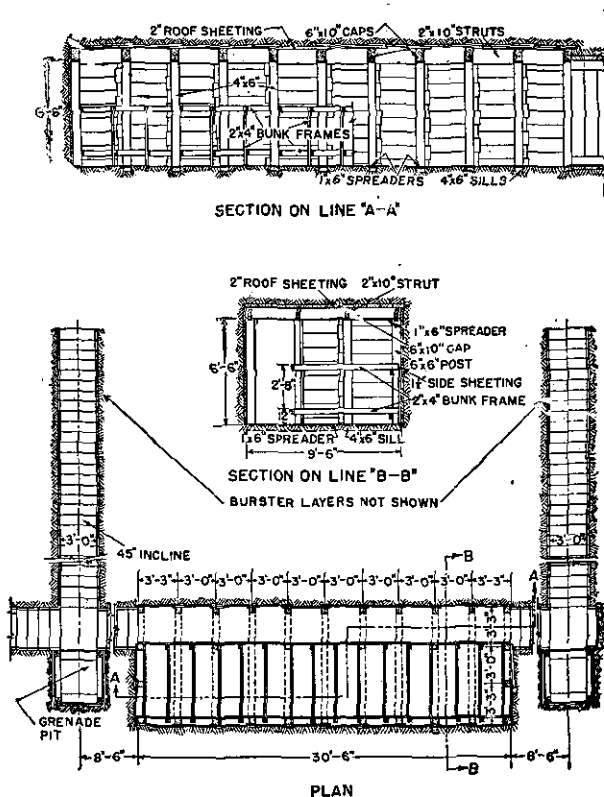

Figure 92. Recess cave shelter.

gallery types; figure 92 and table XX, the recess type with inclines; figure 93, the recess type with vertical shafts; and figure 94 and table XXI, the gallery type.

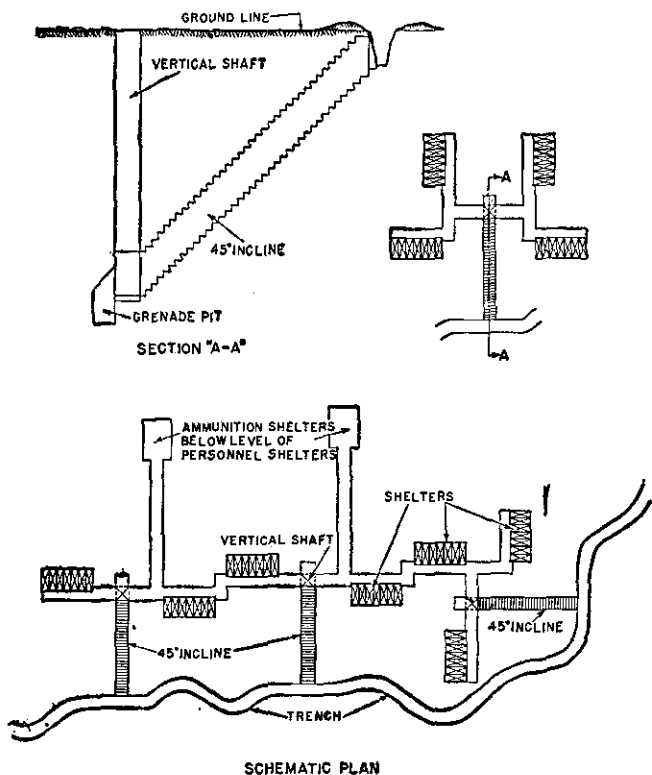

Figure 93. Schematic lay-out of recess cave shelter with vertical shafts.

TABLE XX. Bill of material for recess cave shelter (fig. 92)
Chamber

Item	Size	Unit	Quantity	Weight (pounds)
Gallery frames	Chamber	Each	11 (2)	5, 170
Posts, end frame only	6 by 6 inches by 14 feet	Each	2	336
Posts, bunk	4 by 4 inches by 14 feet	Each	2 (½)	150
Struts	2 by 10 inches by 10 feet	Each	10 (1)	167
Bunk frame, lengthwise	2 by 4 inches by 12 feet	Each	10 (2)	320
Bunk frame, crosswise	2 by 4 inches by 14 feet	Each	16 (3)	594
Post, bunk	2 by 4 inches by 16 feet	Each	5 (1)	213
Sheeting, top ¹	2 by 10 inches by 4 feet	Each	70 (12)	1, 864
Do	2 by 8 inches by 4 feet	Each	24 (5)	512
Do	2 by 6 inches by 4 feet	Each	32 (6)	512
Do	2 by 4 inches by 4 feet	Each	47 (9)	500
Sheeting, side ²	1½ by 10 inches by 4 feet	Each	102 (20)	2, 040
Do	1½ by 8 inches by 4 feet	Each	35 (7)	560
Do	1½ by 6 inches by 4 feet	Each	46 (9)	552
Do	1½ by 4 inches by 4 feet	Each	69 (12)	552
Sheeting, ends ²	1½ by 10 inches by 4 feet	Each	20	400
Do	1½ by 8 inches by 4 feet	Each	7	112
Do	1½ by 6 inches by 4 feet	Each	9	108
Do	1½ by 4 inches by 4 feet	Each	12	96
Wedges	Standard	Each	120 (25)	168
Wire netting, bunks	72 inches wide, 2-inch mesh	Linear feet	250 (50)	125
Wire, galvanized, bunks	10-gauge	Linear feet	825 (165)	41

See footnotes at end of table.

TABLE XX. Bill of material for recess cave shelter (fig. 92)—Continued

Chamber—Continued

Item	Size	Unit	Quantity ¹	Weight (pounds)
Staple, bunk	3/8-inch, No. 9	Pound	15 (3)	15
Nails	10d	Pound	10 (2)	10
Do	30d	Pound	10 (2)	10
Total weight				15, 127

Two passages

Gallery cases	Common	Each	18 (7)	3, 960
Battens	1 by 6 inches by 8 feet	Each	8 (4)	128
Nails	10d	Pound	4 (2)	4
Total weight				4, 092

Two grenade pits

Gallery cases	Common	Each	8	1, 760
Gallery frames	Common	Each	4	1, 024
Sheeting, top ²	2 by 10 inches by 5 feet	Each	10	333
Do	2 by 6 inches by 5 feet	Each	5	100

Sheeting, sides ²	1½ by 10 inches by 5 feet.....	Each.....	39	975
Do.....	1½ by 6 inches by 5 feet.....	Each.....	29	435
Sideboards.....	1½ by 10 inches by 4 feet.....	Each.....	8	160
Deflector boards.....	1½ by 6 inches by 5 feet.....	Each.....	12	180
Struts.....	2 by 10 inches by 4 feet.....	Each.....	4	107
Battens.....	1 by 6 inches by 12 feet.....	Each.....	4	96
Nails.....	10d.....	Pound.....	10	10
Wedges.....	Standard.....	Pound.....	25	35
Total weight.....				5, 215

Two inclines (25 feet between landings)

Gallery cases.....	Common.....	Each.....	60 (7)	13, 200
Battens.....	1 by 6 inches by 10 feet.....	Each.....	34 (4)	680
Headers and risers.....	1½ by 10 inches by 4 feet.....	Each.....	120 (14)	2, 400
Sheeting, top (bottom landing). ²	2 by 10 inches by 4 feet.....	Each.....	10	268
Sheeting, side and floor (bottom landing). ²	1½ by 10 inches by 4 feet.....	Each.....	28	560
Baffle board.....	1½ by 10 inches by 6 feet.....	Each.....	2	60
Wedges.....	Standard.....	Each.....	100 (15)	140
Nails.....	10d.....	Pound.....	12 (2)	12
Sandbags.....	Standard.....	Each.....	100	50
Total weight.....				17, 370

See footnotes at end of table.

TABLE XX. Bill of material for recess cape shelter (fig. 92)—Continued

Two air locks

Item	Size	Unit	Quantity ¹	Weight (pounds)
Curtain frame	2 by 4 inches by 12 feet	Each	4	128
Curtain shelf	1 by 6 inches by 6 feet	Each	2	24
Curtain frame	1 by 2 inches by 12 feet	Each	4	32
Gas curtains	M1	Each	4	58
Nails	10d	Pound	3	(boxed)
Total weight				3
				245

Bill of material (consolidated)

Item	Unit	Quantity	Weight (pounds)
Gallery frames, chamber size	Each	11	5, 170
Gallery frames, common size	Each	4	1, 024
Gallery cases, common size	Each	86	18, 920
6 by 6 inches by 14 feet	Each	2	336
4 by 4 inches by 14 feet	Each	2	150
2 by 10 inches by 10 feet	Each	10	167
2 by 10 inches by 5 feet	Each	10	333
2 by 10 inches by 4 feet	Each	84	2, 239

2 by 8 inches by 4 feet	Each	24	512
2 by 6 inches by 5 feet	Each	5	100
2 by 6 inches by 4 feet	Each	32	512
2 by 4 inches by 16 feet	Each	5	213
2 by 4 inches by 14 feet	Each	16	594
2 by 4 inches by 12 feet	Each	14	448
2 by 4 inches by 4 feet	Each	47	500
1½ by 10 inches by 6 feet	Each	2	60
1½ by 10 inches by 5 feet	Each	39	975
1½ by 10 inches by 4 feet	Each	280	5,560
1½ by 8 inches by 4 feet	Each	42	5,672
1½ by 6 inches by 5 feet	Each	41	615
1½ by 6 inches by 4 feet	Each	55	660
1½ by 4 inches by 4 feet	Each	81	648
1 by 6 inches by 12 feet	Each	4	96
1 by 6 inches by 10 feet	Each	34	680
1 by 6 inches by 8 feet	Each	8	128
1 by 6 inches by 6 feet	Each	2	24
1 by 2 inches by 12 feet	Each	4	32
Wedges	Each	245	343
Wire netting, 72 in. wide, 2-in. mesh	Linear foot	250	125
Wire, galvanized, 10-gauge	Linear foot	825	41
Staples, ¾-in. No. 9	Pound	15	15
Nails, 10d	Pound	39	39
Nails, 30d	Pound	10	10
Sandbags	Each	100	50
Gas curtains M1	Each	4	58 (boxed)
Total weight			42,049

See footnotes at end of table.

TABLE XX. *Bill of material for recess cave shelter (fig. 92)—Continued*
Summary

Item	Pounds	Tons
Lumber-----	41,368	20.68
Miscellaneous-----	681	.34
Total weight-----	42,049	21.02

! Figures in parentheses show quantities required for a unit length of 6 feet.

* Sheeting of different width may be substituted for that shown, but an equivalent total width of sheeting must be furnished.

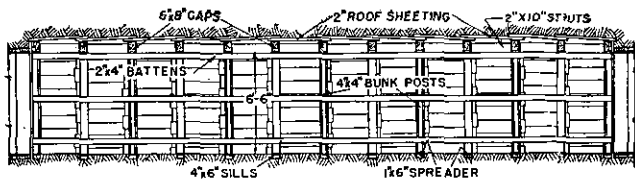

SECTION ON LINE "A-A"

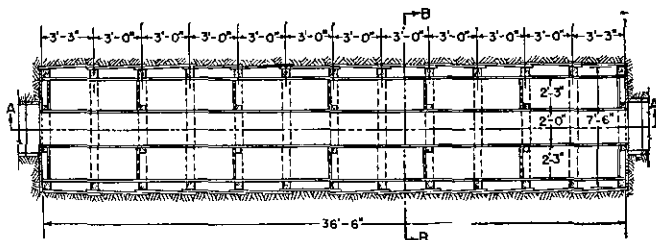

PLAN

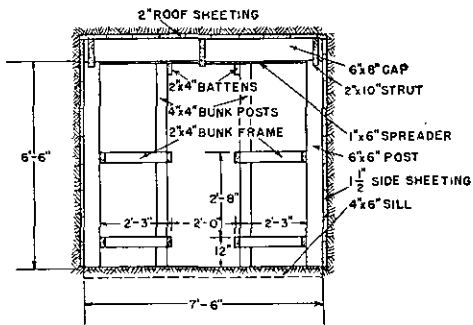

SECTION ON LINE "B-B"

Figure 94. Gallery type cave shelter.

TABLE XXI. Bill of materials for gallery-type cave shelter (fig. 94)
Chamber

Item	Size	Unit	Quantity ¹	Weight (pounds)
Gallery frames	Great	Each	13 (2)	4, 680
Posts, bunk	4 by 4 inches by 8 feet	Each	14 (2)	600
Struts	2 by 10 inches by 8 feet	Each	12 (2)	640
Bunk frame, crosswise, to cut	2 by 4 inches by 8 feet	Each	7 (1)	148
Bunk frame, lengthwise	2 by 4 inches by 14 feet	Each	25 (4)	932
Battens	2 by 4 inches by 12 feet	Each	7 (1)	224
Sheeting, top ²	2 by 10 inches by 4 feet	Each	66 (11)	1, 760
Do	2 by 8 inches by 4 feet	Each	22 (4)	470
Do	2 by 6 inches by 4 feet	Each	30 (5)	480
Do	2 by 4 inches by 4 feet	Each	45 (7)	120
Sheeting, side ²	1½ by 10 inches by 4 feet	Each	132 (22)	2, 640
Do	1½ by 8 inches by 4 feet	Each	44 (8)	704
Do	1½ by 6 inches by 4 feet	Each	60 (10)	720
Do	1½ by 4 inches by 4 feet	Each	90 (14)	720
Sheeting, ends ²	1½ by 10 inches by 4 feet	Each	22	440
Do	1½ by 8 inches by 4 feet	Each	8	128
Do	1½ by 6 inches by 4 feet	Each	10	120
Do	1½ by 4 inches by 4 feet	Each	14	112
Wedges	Standard	Each	145 (24)	203
Wire netting, bunk	72 inches wide, 2-inch mesh	Linear feet	100 (30)	50
Wire, galvanized, bunk	10-gauge	Linear feet	600 (100)	30
Staples	¾-inch, No. 9	Pound	12 (2)	12
Nails	10d	Pound	6 (1)	6
Do	30d	Pound	6 (1)	6
Total weight				15, 965

¹ Figures in parentheses show quantities required for unit length of 6 feet.

² Sheeting of different width may be substituted for that shown, but an equivalent total width of sheeting must be furnished.

b. Command posts (fig. 95). Command posts layouts are not standardized. Note that in figure 95 passages are common-gallery size and rooms are chamber-gallery size, similar to those in figure 92. Command

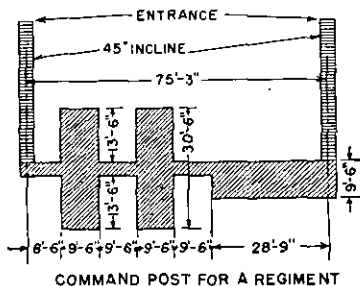
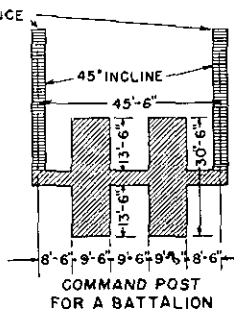
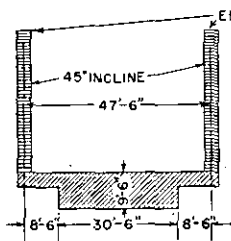
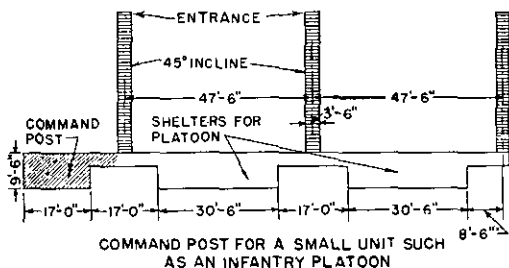

Figure 95. Typical lay-out of cave shelters used for command posts, showing entrances and inclines.

posts for larger units generally consist of long, recessed chambers along the passage to accommodate enlisted men's bunks, and small chambers at right angles

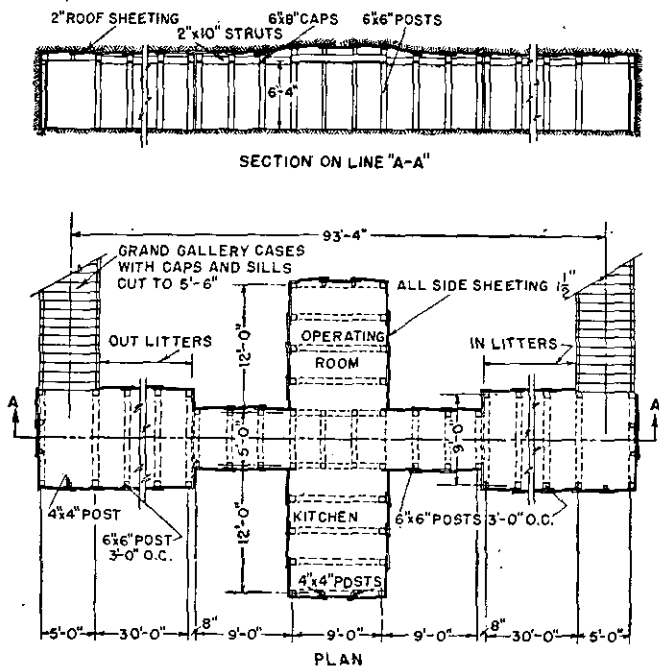

Figure 96. Cave shelter for aid station.

to the passage, normally used as combined offices and quarters for commissioned personnel. The maximum length of these rooms without ventilating holes or shafts is 15 feet. In computing floor space of command post shelters, the area of passages is not included.

c. First-aid shelters. Figure 96 shows passages, aisles, and inclines adapted for the movement of litters. The rooms are made with standard chamber-gallery frames, and the connecting aisles with great-gallery

frames having caps and sills shortened to 5½ feet. The usual 45° incline is too steep for handling litters and should be reduced to 31° for this type of shelter.

79. CLASSIFICATION. Cave shelters are classified as the *recess type* and *gallery type* (fig. 91).

a. The *recess type* is 8½ feet wall-to-wall, and employs the chamber gallery. The passage is at one side, with bunks perpendicular to the passage. The shelter is economical in space, labor, and material, requirements being 75 cubic feet of excavation and 113 board feet of lumber per occupant. It is used wherever conditions permit.

b. The *gallery type* is 6½ feet wall-to-wall, and employs the great gallery. The connecting passage or entrance is along the main axis of the chamber, with bunks on both sides paralleling the passage. Simpler to construct than the recess type, this advantage is cancelled by its larger excavation and material requirements—93 cubic feet of excavation and 185 board feet of lumber per occupant.

80. REQUIREMENTS. The factors to be considered are: approach to entrances; entrances, which may be inclined or not, as conditions require; room or chamber proper; and connecting passages.

81. EXCAVATION. a. **Tools.** The pick, shovel, crowbar and pick mattock are the primary tools in earth excavation. In advancing an incline or gallery only enough ground is opened up to accommodate the timbering.

b. **Removal of excavated material.** In small headings spoil is shoveled into bags, which are carried to the place of disposal. In fairly large headings, wheel-

barrows and small tramcars may be used. The removal of spoil through shafts is ordinarily by buckets and hand-operated windlasses or small power hoists.

c. Concealment. When the shelter is close to the enemy, spoil is deposited temporarily in those dumps which can be used by day unobserved by the enemy. At night men place the spoil in shell holes, old mine craters, abandoned trenches, sunken roads, behind hedges, or any other places concealed from the enemy in daylight. It is bad practice to build mounds of spoil. All material must be carefully concealed, or camouflaged against airplane observation, since fresh spoil of whatever color is easily identified on enemy aerial photographs. The path to the place of disposal must be concealed, to prevent the tracks showing on aerial photographs.

82. ENTRANCES (fig. 97). There should be at least 1 foot of initial headcover over the top of the first case of the entrance proper; and a burster course of 5 to 12 inches of rock, broken stone, or concrete slabs is placed above the entrance not more than 1 foot from the surface. No attempt should be made to strengthen the head of the incline by logs, rails, I-beams, concrete arches, extra heavy timbers, or complicated bracing. If hit, such material is likely to cause a serious block because of the difficulty of clearing away debris in the entrance. The only protection against grenades being thrown in the entrance is a lined pit 6 feet deep at bottom of the inclined shaft (see fig. 98). This is constructed after the shelter is completed, and also acts as a sump. It must be kept clear of debris. Grenade pits are installed only where ground raids are likely to occur. The best protection for entrances is concealment from ground observation and from aerial photography.

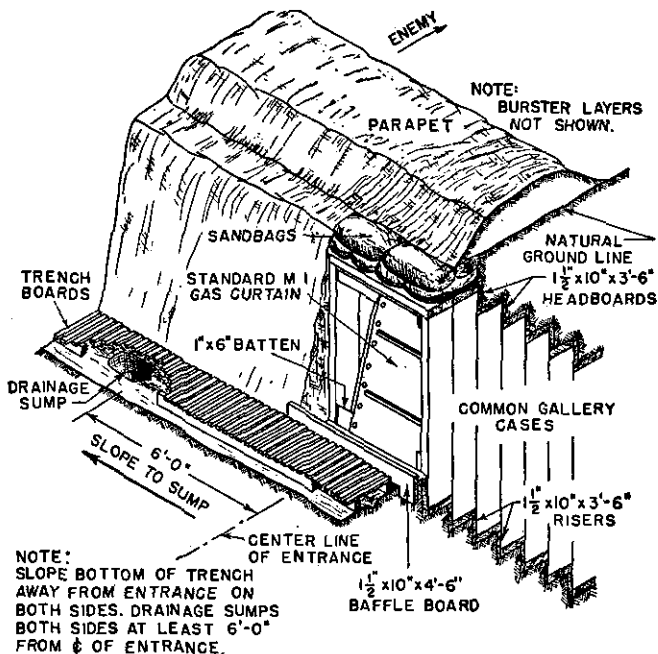

Figure 97. Approach and entrance to incline to cave shelter.

(See FM 5-20.) To avoid ground observation, entrances are located on places such as reverse slopes and along sunken roads. To avoid detection by aerial photograph, they are located in trenches used for other purposes, or along other traveled routes. Locating shelters in woods protects them from both ground and air observation.

83. APPROACH. a. **Definition.** The approach is that portion of ground in front of the entrance to underground works which must be excavated to provide necessary headroom without sacrificing overhead cover.

The approach usually is necessary, whether the entrance is from a trench (fig. 97) or from a reverse slope.

b. Approach from reverse slope. Except in cases where the entrance is from an existing trench, or where a reverse slope entry is made in a nearly vertical face, an approach is necessary to reach the first timbered section. Usually, it consists of a narrow trench driven forward into the slope on a slight upgrade to facilitate drainage, until a vertical face is obtained high enough for installation of the first gallery case. Revetment usually is needed near the entrance and, being conspicuous on an aerial photograph, the approach must be carefully camouflaged both during construction and after completion.

84. DRIVING AN INCLINE WITH CASES. a. Normal construction. (1) To standardize construction, a single type of incline, using standard gallery cases placed vertically, is employed (fig. 98). This type, also known as the stepped incline, may be built by unskilled labor. The normal size of case is the common gallery type.

In driving an incline with cases (fig. 98) the dimensions of a common gallery case are marked on the ground at the site of the entrance. Standard common gallery cases are used except at the top of inclines of standard trenches, where the posts of the first case are sawed to 5 feet 8 inches instead of 6 feet 6 inches, giving 4 feet 9 inches of headroom. This reduction in the size of the first case is necessary to maintain adequate overhead cover above the entrance to the incline.

(2) Excavation for the sill of each successive case is lowered 10 inches, providing for steps. Cases are used as described above, except that headboards and

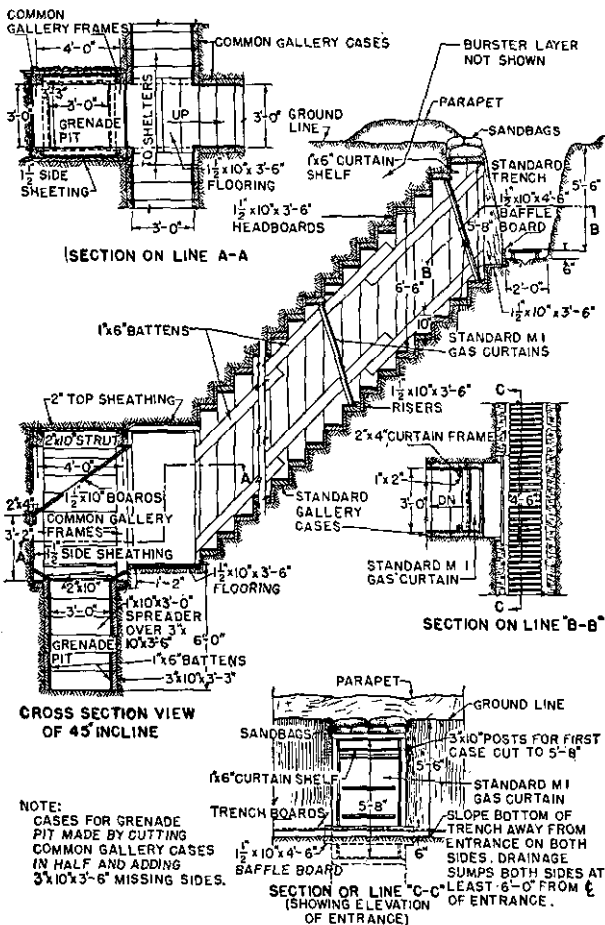
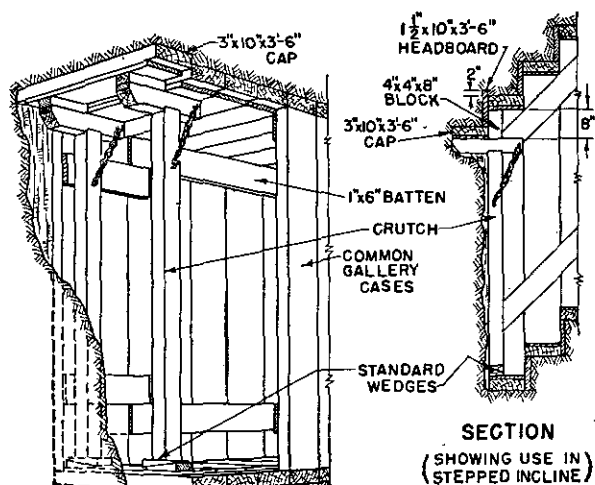

Figure 98. Incline for cave shelter.

risers are nailed in position to prevent earth from caving between successive caps and sills. The timbering follows the excavation closely, to prevent "runs" in face or sides.

(3) In loose, caving soil, the cap must be put in position first and supported while grooves for the ground sill and posts are excavated. Two "crutches" (fig. 99) are used for supports. A crutch is an upright



PERSPECTIVE VIEW
(SHOWING USE IN PASSAGE)

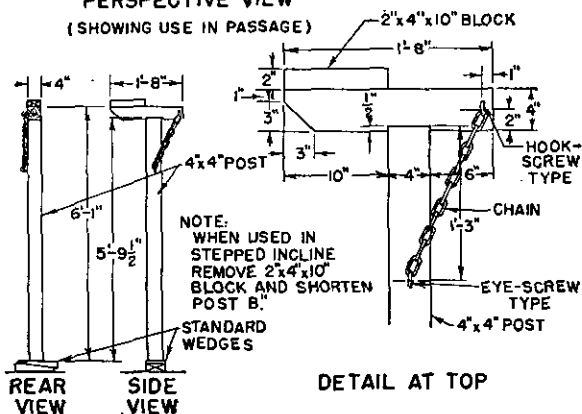

DETAIL AT TOP

Figure 99. Use of "crutches" in driving gallery with cases.

piece of timber carrying a crosspiece equal in length to the width of two cases. The upright piece rests upon the ground sill of a case already placed, and is raised to proper height by wedges. The part of the crosspiece which projects forward is made 2 inches higher than the rear part, to support the cap somewhat above its final level and to allow posts to be easily inserted (fig. 99). The rear part is attached to the upright piece by an iron rod or short chain. When the case is set and adjusted to position, crutches are taken down by removing the wedges, and are placed under the next cap.

(4) Immediately upon being set, each case is tied to the top and bottom of the previous one by short lengths of sheeting. These are later replaced by 1-by 6-inch battens (see app. I). The number of cases required for a 45° incline for any depth equals the vertical depth between levels in inches divided by 10 minus 1.

b. First-aid shelter construction. The construction of inclines for first-aid shelters is similar to normal construction, except that a case of larger size than the common-gallery type is ordinarily used. While a 45° slope is usually used for most inclines, a lesser slope is preferred for first-aid shelters. A 31° slope is frequently used, in which event the number of cases equals twice the difference in feet in elevation between levels minus 1. This is based on a stairway with 6-inch risers and 10-inch treads.

85. SINKING A SHAFT. **a. With cases.** Shafts usually are sunk with cases. A shaft case of required size is constructed and placed on the site of the shaft, dimensions of which are marked on the ground outside

the case. The case is removed, and a hole is dug to the depth of the case, which is placed in the excavation with its top flush with the ground. Its position is carefully verified, and it is secured in position by packing earth around it. Excavation is continued for the depth of another case, which is put in place as follows: one endpiece is placed in position; the sides are engaged with the end and pushed back into position; a pocket-shaped excavation is made beyond the end of one of the sidepieces and running back 3 or 4 inches into the side wall; the remaining endpiece is inserted in this cavity far enough to allow its opposite end to slip over the side and fall into place by drawing against the sidepieces. The case may be toenailed and fastened to the higher one by short battens. The next case is placed in the same way, care being taken not to excavate two consecutive pockets in the same corner. Pockets are filled by stuffing earth from below before placing the next case. Upon reaching the level of the top of the gallery, pieces on the gallery side of the shaft are omitted if the ground is firm; but, if it needs support, these pieces are put in place and secured by cleats or braces.

b. With frames and sheeting. In sinking a shaft with frames and sheeting (fig. 100), the size and position of the shaft are fixed first, then the top frame is laid down and staked in place, with guide marks on the endpieces made accurately in the desired position. The excavated area is made enough larger than the top frame to take the sheeting all around. Usually the interval between the first and second frame can be dug without driving sheeting. It should be so undercut that, at the level of the second frame, it will be larger in each direction than at the top by twice the thickness of the sheeting. Gauge rods, cut to the length and

width of the excavation and plainly marked at middle points, should be provided for ease in measuring. The inconvenience of working under the top frame may be avoided by marking the sides of the hole carefully and digging the first interval before setting the top frame.

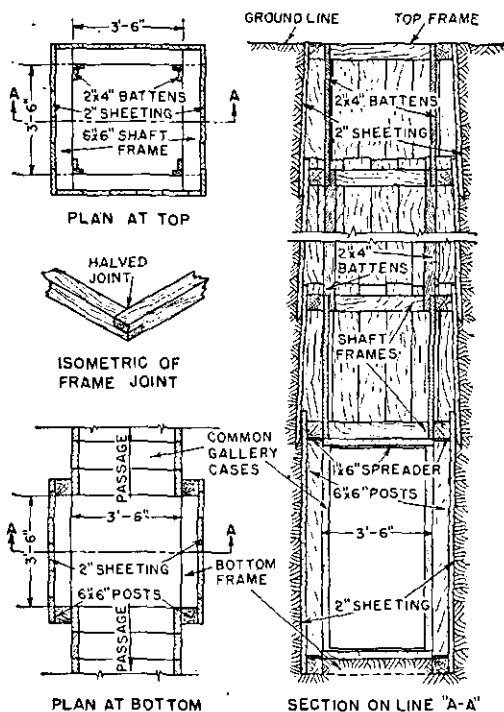

Figure 100. Sinking a shaft with frames and sheeting.

When the shaft is deep enough, the second frame is put in place and *nailed* together. The top and second frame are connected by nailing to them four battens of proper length, two on each side (fig. 100), which suspend the second frame from the top frame at the proper interval.

The second frame is placed vertically below the top frame, using a plumb line.

Sheeting is inserted outside the top frame, beveled end first, bevel inside, and pushed down until its top is flush with the top frame. The lower end of the sheeting is wedged out from the lower frame to permit insertion of second interval sheeting, and excavation of the second interval is commenced. In ordinary soil, the sides of the shaft require support. The sheeting is therefore introduced as the excavation proceeds, wedges previously placed being driven down as the sheeting is inserted. If earth pressure becomes great enough to spring the sheeting planks inward, an auxiliary frame is added. This frame is similar to shaft frames, but 4 to 6 inches larger in outside dimensions. Sheetting rests directly against the outside of this frame, and thus is held far enough out to allow the third frame to be placed and wedges to be inserted as before. The auxiliary frame then is removed and used in the next interval. Successive frames are placed in like manner (fig. 100) until the one directly over the gallery is reached. This frame is placed at exactly the right height and the shaft continued to the required depth. A frame is placed at the bottom, its top level with the gallery floor, and the sheeting is allowed to rest directly against the outside of this frame. When the soil permits the sheeting is omitted, wholly or in part, over the portion of the shaft which is to form the gallery entrance.

c. Precautions. In sinking shafts, special care must be taken to make the excavation no larger than required for placing the lining. If space is left outside the lining, the earth may give throughout the entire height of the shaft, fall against the lining, and crush it in.

86. DRIVING A GALLERY. a. With cases. The operation is the same as for driving an incline with cases, except that the excavation is not stepped and headboards and risers are omitted.

b. With frames and sheeting. (1) Two gauge rods are prepared, giving the extreme height and width of the excavation, that is, the height of the frame plus two thicknesses of top sheeting, and the width of the frame plus four thicknesses of side sheeting. The middle of each gauge rod is marked plainly. A gallery frame is

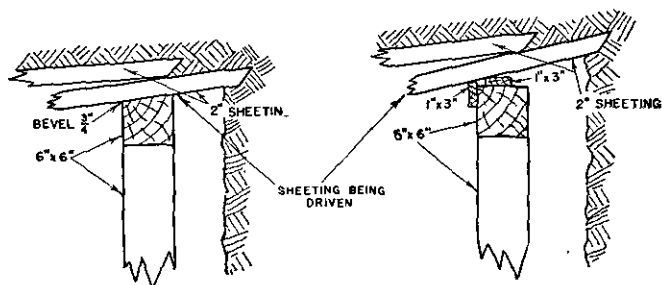

Figure 101. Driving sheeting with beveled cap and cap with strips nailed to it.

set up, carefully located, and fastened in position with battens and braces. The top gallery sheeting is started on top of the cap and driven until held in place by the earth. It is given the upward pitch necessary to make room for placing the next frame and sheeting by a beveled cap, or by strips fastened on top and on the rear face of a cap (fig. 101). The side sheeting is started in the same way against the outer faces of the posts, and is given an outward slant by bracing the outer ends slightly away from the sides of the gallery. Earth is excavated and the sheeting advanced, keeping the front

ends in solid earth to hold them steady and to give protection to workmen.

(2) When the gallery is advanced one interval, usually about 3 or 4 feet, a second frame is placed. Its position is verified by the guide marks; its direction by a line; its grade by a spirit, mason's, or field level; and its plumb by a plumb line. It is secured in place by nailing battens to it and to the preceding frame.

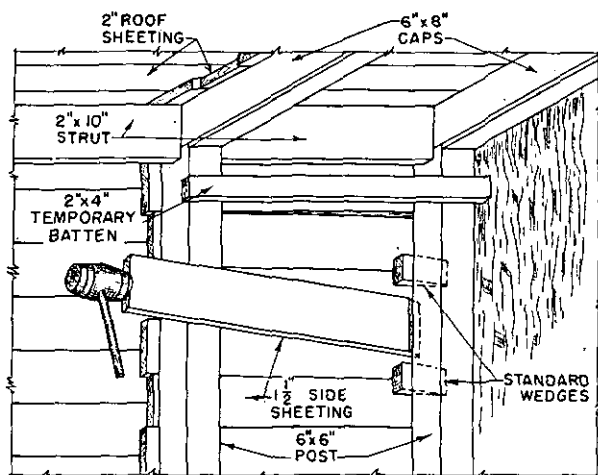
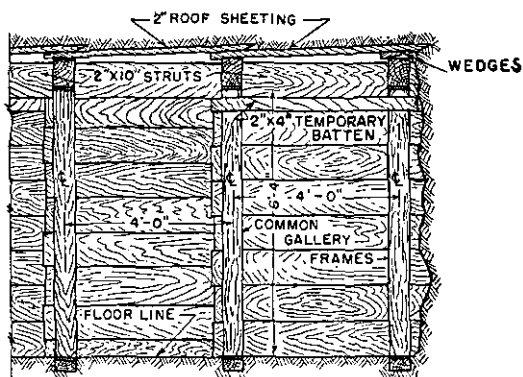

Figure 102. Using wedges in driving sheeting.

Wedges are inserted between the second frame and the sheeting, to allow room for insertion of the sheeting for the next interval, and the gallery is continued by the same method (figs. 102, 103.) When the sheeting can be advanced only by hard driving, the frames are inclined slightly to the rear and afterwards driven forward until vertical.

(3) If, while advancing the sheeting, the pressure becomes so great as to spring it, a false frame must be

used (figs. 104 and 105). This consists of a cap, a sill, and two posts connected by mortises and tenons. Posts have tenons and cap and sill have mortises at each end. The cap may be rounded on top and, for facility in set-



SECTION ON LINE "A-A"

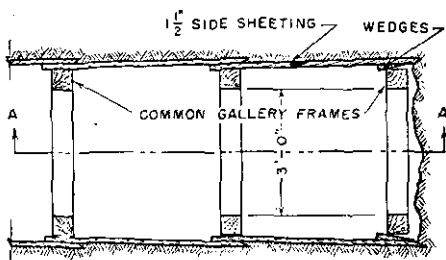

PLAN

Figure 103. Wall and roof sheathing showing wedges.

ting up and removing, its mortises are longer than the width of the tenons. The latter are held in place by key wedges when the frame is in position (fig. 105). The false frame is usually made the same height as the common frames, and wider by twice the thickness of

the sheeting. In using this frame, the sill is placed accurately in position a half-interval in advance, posts are set up, and the cap placed upon them and wedged.

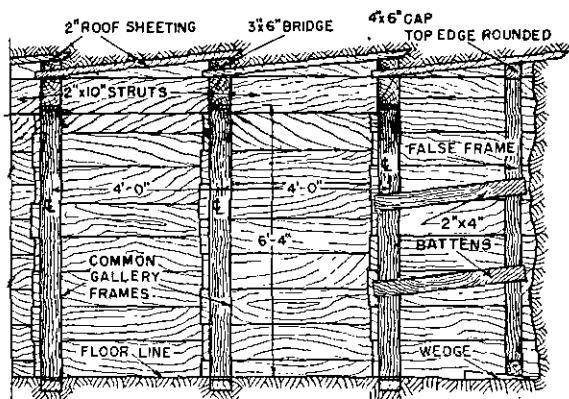

SECTION ON LINE "A-A"

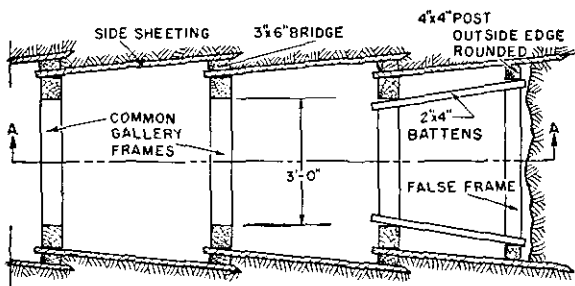

Figure 104. Details of construction using false frame.

The whole frame is then raised about 2 inches by driving wedges under the sill, and is secured by battens (fig. 105.) The sheeting now rests directly upon the cap and posts, and has enough slant to clear the next frame by its own thickness. The next frame is set up, wedges driven under the sheeting, and the false frame is removed.

(4) In loose, caving ground, when pressure on the sheeting is too great for driving, it is relieved by the use

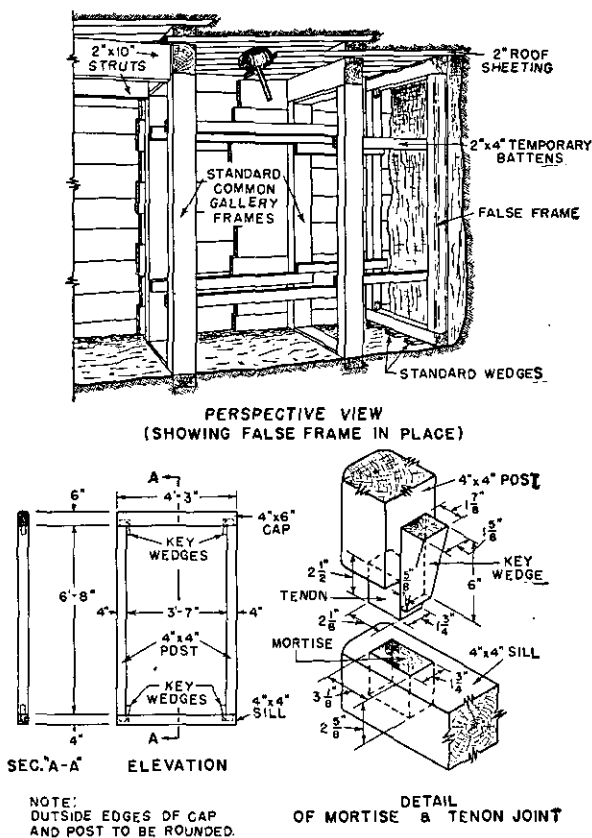

Figure 105. Perspective view and detail of false frame.

of bridges (fig. 106). These consist of 3-inch blocks equal in width and length to the cap or post. The frame being in position, a bridge is placed over the cap, supported at each end by wedges having the thickness of

the sheeting. The bridge keeps the rear sheeting from bearing hard on the cap, thereby allowing an opening through which the forward sheeting is driven (fig. 106). As the sheeting is driven forward piece by piece, it is sometimes necessary to pick material away from the point of each board. In this manner the sheeting is ad-

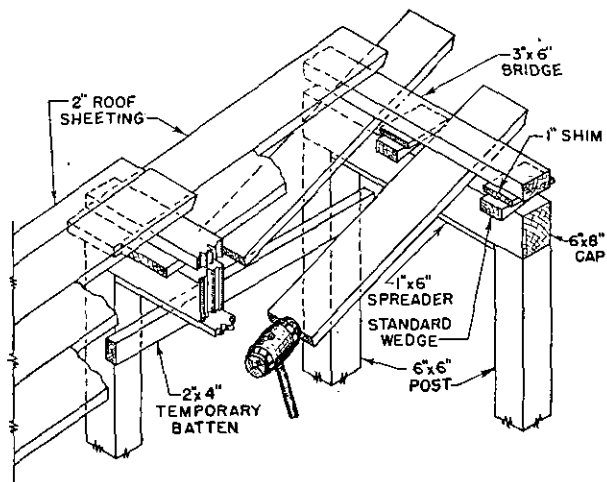

Figure 106. Isometric view showing use of bridge.

vanced to its final position. The next frame is blocked into position, and the same process repeated. When necessary to hold up the sheeting while placing the next frame, a false frame, as described above, or posts and headboard, may be put in place, to be removed when the next permanent frame is placed. Side sheeting is driven as for roof sheeting under similar ground conditions.

(5) To drive the gallery in very loose soil, a *shield* (fig. 107) may be used to prevent earth in front and above from caving into the gallery. When the excava-

tion at the top of the gallery has advanced as far as possible without causing caving to extend beyond the top sheeting, a piece of plank a foot wide and equal in length to the width of the gallery is placed directly under the top sheeting against the face of the excavation (fig. 107), and held in place at its ends by braces secured

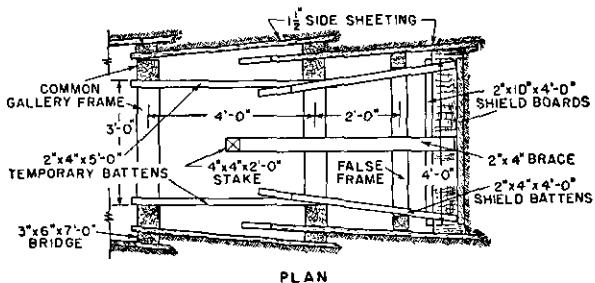
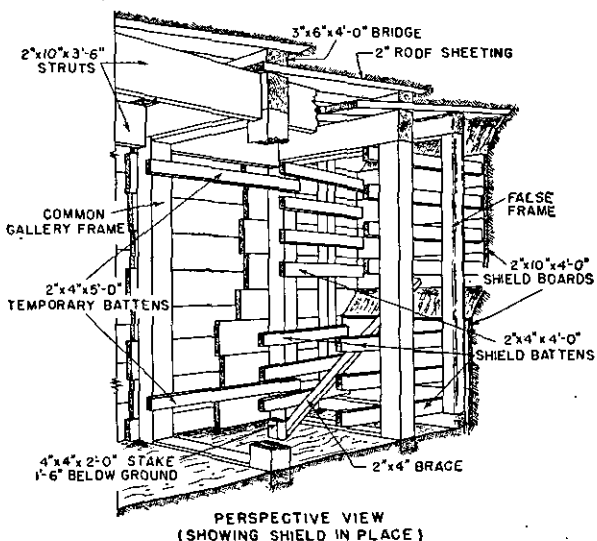

Figure 107. Use of shield in driving sheeting in loose, caving soil.

to the gallery lining. Earth is removed until a second plank of the shield can be placed, in the same way, under the first one. This is continued until the entire face is covered. The top and side sheeting is driven forward, the top plank of the shield is removed, earth is excavated, and the plank placed ahead, after which each plank in turn is removed and placed ahead.

87. CHANGE OF SLOPE. To pass from a horizontal to an ascending gallery (fig. 108) the top sheeting is given the proper angle by holding down its back end with a piece of scantling placed across the gallery, and the side sheeting is given the proper inclination. Trenches are cut in the bottom of the gallery for the lower pieces, if necessary. In passing from a horizontal to a descending gallery (fig. 117), the roof may be carried forward horizontally and the floor given the desired pitch by increasing the height of successive frames until enough headroom is obtained to allow inserting the top sheeting for the descending gallery at the proper height and in the new direction. The frame at this point is made with a cap upon which sheeting rests directly, and a second crosspiece below it, serving as a cap for the descending gallery. From this point forward, frames may be set at right angles to the axis of the gallery. If the descending gallery is very steep, and the horizontal pressure of the soil is great, it may be necessary to strengthen the posts of the last two or three vertical frames by crosspieces near their upper ends.

88. CHANGING DIRECTION HORIZONTALLY. a. In changing direction horizontally with frames and sheeting, if the soil will stand unsupported for a dis-

tance of one frame interval, it is only necessary to place one or more frames at an angle until the desired change of direction is gained. Sheeting on the outside is

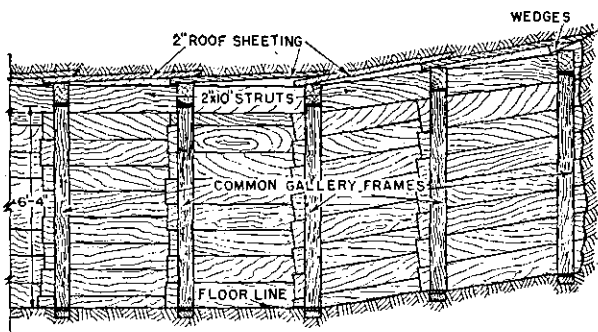

SECTION THRU ASCENDING GALLERY

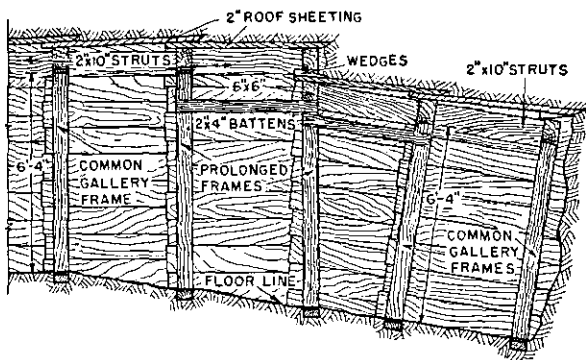

SECTION THRU DESCENDING GALLERY

Figure 108. Details of construction of ascending and descending galleries.

placed by running the forward end past the frame and then inserting the rear end behind the last section of sheeting (fig. 109). A short section of gallery may

be put in to reduce the amount of work (fig. 109). Frames with extra long caps and sills are required, and the last one used is given an extra post on the inside to take sheeting in the new direction.

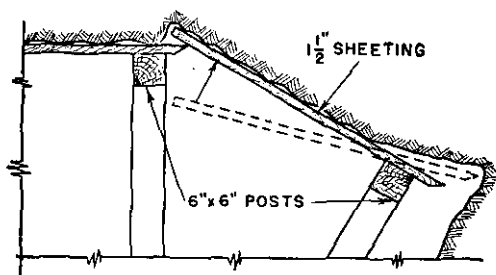

① Outside wall, normal method.

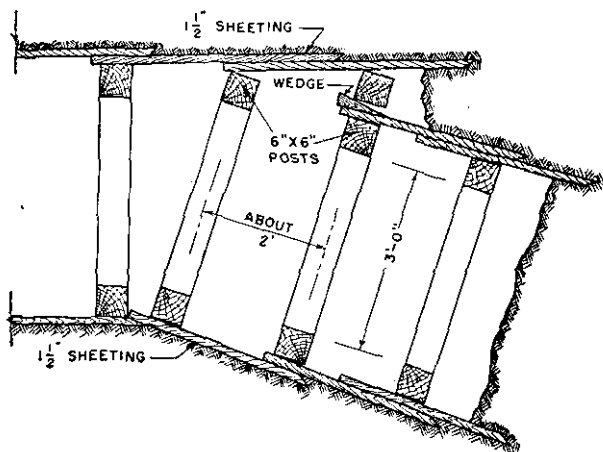

② Alternative method.

Figure 109. Details of changing horizontal direction of gallery.

b. For abrupt changes of direction of large galleries, dig in the original direction past the turning point and then start the branch gallery in the new

direction. (See fig. 110.) The interval between the frames of the gallery of departure at the place of departure must be great enough to admit between them a frame and the side sheeting of the branch.

c. If the branch is oblique to the main gallery, its width measured along the gallery of departure may be

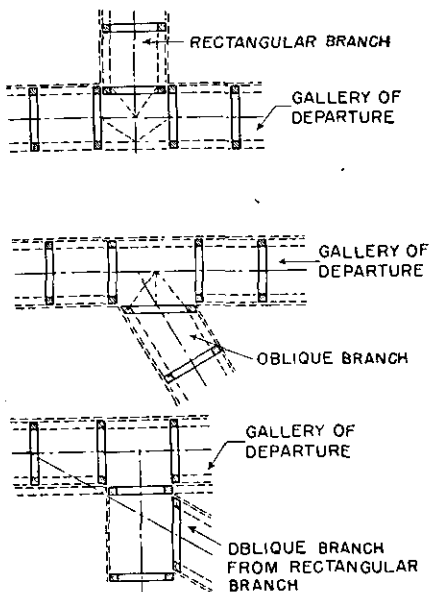

Figure 110. Breaking out branches.

greater than that normally between the frames of the gallery of departure. In this case a short rectangular branch is first broken out from the side of the gallery of departure and the new gallery is broken out from the side of this short branch. The first frame of an oblique branch should be so set that sides of the posts are parallel to side walls of the branch, thus giving good bearing to the side sheeting.

d. The floor of a branch is started at the level of the floor of the gallery of departure. In soil which will stand for a short time without support, the first frame may be set up entirely outside the gallery of departure and may be the same height in the clear as this gallery. However, when side sheeting is required in the gallery of departure, the first frame of the branch must be set up against this sheeting in the interval between posts. This makes the clear height of the branch at this frame less than that of the gallery of departure by a little more than the thickness of the sheeting. When the first frame of the branch is set against the sheeting of the gallery of departure, the sheeting may be pulled or cut away to permit excavation, in either case beginning with the top plank.

89. CHAMBERS. In excavating a wide chamber, care must be taken to prevent earth from falling from the roof. Excavation of the entire width of the chamber at the same time should not be attempted. Until the roof sheeting can be placed, the roof is supported by an earth column left standing in the chamber, and excavation for the side sheeting and next frame is made around this column. The earth column is gradually removed as the roof sheeting is placed.

90. LINES AND GRADES. **a. Line.** In timber construction, a string stretched along shallow saw cuts in the centers of caps and sills is the simplest method of maintaining straight lines. Plumb bobs hung from nails in the center of caps are used for lining by eye. Sills are leveled and posts plumbed, while the frame or case is being lined and blocked into place.

b. Grades. The minimum grade that will insure drainage in galleries and chambers is about 1 foot per

100 feet (1 percent). Uniform grades are difficult to maintain without a level and a grade board. A convenient size of grade board is made from a straight-edge piece of 1½-by-6-inch lumber, 6 to 12 feet long, with a small cleat nailed on one end. The cleat is of such thickness that, when the board is placed on a surface with a carpenter's level on top, the desired grade is obtained when the level bubble is centered.

91. PLANS AND LAY-OUT. **a. Plans.** Before starting work, location sketches showing over-all dimensions are necessary so the proper material may be ordered or prepared.

b. Lay-out. Work is simplified if the shelter is placed so that all entrances are perpendicular to the center line of the chamber. The chamber is built so that its longest dimension is perpendicular to the probable direction of enemy fire. Lay a base line parallel to the long axis of the chamber, and mark this line so that it can be relaid easily, should it be destroyed. Mark the center lines of the entrances on the base line, and from each side of the mark, at a distance equal to one-half the outside width of the entrance, erect perpendicular lines to points where the first frames are to be placed. Perpendiculars to the ends of a frame must be of equal length, so that the first frames will be set parallel to the base line. It is important that these first frames be set accurately. The horizontal distance of each frame from the base line and the difference in elevation between the various frames must be determined, usually with a carpenter's level and square. The axis of incline must be carried in a plane perpendicular to the base line, usually by sighting along the sides of the incline.

92. RATE OF WORK. For calculating the size of working parties and the rate of work (including timbering, but exclusive of disposal of spoil on the surface), the following figures may be accepted as average:

a. Inclines. *Common gallery, size 6 feet 4 inches by 3 feet, inside clear dimensions.* One relief includes: one man picking and timbering; one man filling sandbags and timbering; and one man carrying for each 10 feet from working face to entrance. Average progress for each 8-hour shift, about 3 feet 6 inches.

b. Passages. *Galleries, common gallery size:* working party the same as for inclines; average progress for each 8-hour shift, about 4 feet.

c. Chambers. (1) *Chamber gallery size, 6 feet 4 inches by 8 feet 6 inches, inside clear dimensions:* two men picking; four men filling sandbags and timbering, who relieve pickmen as they tire; add two men for each 10 feet of carry; average progress for each 8-hour shift, about 3 feet.

(2) *Great gallery size, 6 feet 4 inches by 6 feet 6 inches, inside clear dimensions:* working party same as for chamber gallery; average progress for each 8-hour shift, about 3 feet 6 inches.

d. Surface carrying party. One man can carry 100 sandbags for 200 feet in 8 hours under ordinary trench conditions. One bag equals 0.5 cubic foot or about 50 pounds.

APPENDIX I

GLOSSARY OF TERMS

The terms used in this manual are defined as follows:

Air lock. An intermediate chamber, with a gasproof curtain at each end, located between the outside and inside of a shelter (fig. 70).

Angle of repose. The steepest slope at which a heap of material, such as earth, will stand without sliding.

Batten. A strip of wood used for nailing across two other pieces to hold them together, for covering a crack, or for holding tarpaper against wood.

Bay. The straight section of a trench between two bends.

Brush revetment. Cut brush held against a wall by pickets (fig. 14).

Brushwood hurdle. A woven rectangle of brushwood used as a revetment (fig. 13).

Burster blocks. Prefabricated, reinforced concrete blocks so designed that a number can be wired together to form a burster course (fig. 73).

Chamber. An enlarged room in a shelter, used as a bunkroom or for other purposes.

Choked end. The end of a filled sandbag that has been tied with twine.

Crutch. An upright piece of timber with a cross piece at the top, used while driving a gallery as support for the caps until the posts for that purpose can be inserted (fig. 99).

Dannert barbed-wire concertina. Prefabricated wire-roll obstacle made of high-strength-steel barbed wire.

Drainage lines. Channels or low lines of the terrain in which water flows either continuously or intermittently.

Flume. An open wooden channel conveying water.

Gauge rod. A stick, cut to a definite length and marked at certain intervals, used for checking the size of the excavation while driving galleries.

Gallery cases. Prefabricated framework used to line galleries.

Gallery frames. Framework which holds in place sheeting used to line galleries.

Grenade pit. A pit, usually at the end of an incline, to catch hand grenades and limit the effects of their explosion (fig. 98).

Header. Sandbag, stone, or brick laid with its long dimensions at right angles to the face of a wall.

Impact velocity. Speed of a projectile at the moment of striking.

Incline. An ascending or descending gallery (fig. 98).

Man-hour. The amount of work an average man can do in one hour.

Outrigger trench. Special excavations required for the outriggers of the 90-mm antiaircraft gun.

Perforation. The passage of a missile completely through an object.

Picket. A stake of wood, wrought iron, or steel used in constructing revetments and wire obstacles.

Rabbet. A groove or notch cut in one timber member to aid in joining it to another.

Scabbing. The breaking off of fragments on the inside of a wall of hard material due to the impact or explosion of a projectile on the outside.

Shaft. A vertical opening of limited cross section used for ventilating underground shelters and as an emergency exit.

Shaft cases. Standard size frameworks used to line a shaft.

Shaft frames. Frameworks holding in place sheeting used to line a shaft.

Sheeting. Planks used to line a gallery or shaft.

Slope. The measure of an incline, wall, or ramp in terms of the ratio of vertical rise in a given horizontal distance to that horizontal distance.

Special trench. A trench, 2 feet wide or less and from 3 to 5 feet deep, used primarily for protection of personnel at artillery and rear installations (fig. 39).

Stabilized soil. Soil hardened by addition of a binder such as cement.

Standard trench. Trench of uniform cross section that can be used either as a fire or communication trench (fig. 40① and ②).

Stretcher. Sandbag laid with its long dimension parallel to the face of a wall.

Sump. A pit in the bottom of an excavation to collect drain water so it can be pumped or bailed out.

Thin natural screen. Natural growth left in front of entrenchments and emplacements to aid in concealing them.

Trail support. A log or other object placed under a trail spade of an artillery piece to provide additional resistance to recoil (fig. 52).

Trench boards. Flooring used in trenches (fig. 41).

APPENDIX II

EFFECTS OF BOMBS AND PROJECTILES

1. PURPOSE. Fortifications are designed primarily to withstand effects of bombs and projectiles. The degree of protection provided is dependent upon the time, materials, and tools available and the types of bombs and projectiles likely to be used. This appendix is a guide to be followed in designing protective walls and covers of fortifications. It describes the effects of various classes of bombs and projectiles, and indicates the thickness of different materials required to protect against these effects.

2. CLASSES OF EFFECTS. The action of bombs and projectiles striking their targets may be considered under the following:

a. Explosion upon impact. Bombs and projectiles that contain explosives and have instantaneous fuzes explode upon striking any surface, and are used primarily against personnel above ground level. Walls and cover thick enough to resist blast and penetration of fragments give adequate protection.

b. Penetration. Small arms and other direct-fire weapons whose projectiles do not contain an explosive charge depend upon perforation and scabbing for their effect. The depth of penetration depends upon striking velocity, size, shape, and weight of the projectiles, and upon the material they strike. Adequate protection can be obtained by getting below ground level or behind walls thick enough to resist penetration.

c. Penetration and explosion. Bombs and explosive projectiles equipped with delayed-action fuzes combine the effects of penetration and rupture from explosion. Adequate protection requires cover and walls thick enough to resist penetration plus rupture and floors thick enough to resist rupture.

3. PROTECTIVE THICKNESS. Protective thickness is that thickness of a material which is required to protect against any or all of the effects described in paragraph 2. Until quite recently there had been a scarcity of data on protective thickness. An extensive program of tests is being followed, but results are not available for inclusion in this manual. The figures given in tables XXII, XXIII, and XXIV are approximations and are not necessarily minimum safe figures. They are based upon empirical formulas checked against such tests as previously were made, and contain a factor of safety large enough to give the indicated protection under ordinary conditions. Figures are given for typical soils and other materials found under field conditions.

TABLE XXII. Required thickness in feet of overhead cover for protection against penetration plus explosion

Protective material	High explosive shell				General purpose bombs		
	75-mm	105-mm	155-mm	100-pound	250-pound	500-pound	
	Reinforced concrete (4,000 pounds/square in.)	1	2½	3½	4	5	7
Stone masonry or plain concrete	1½	3½	5	6	8	9½	
Logs, 8-inch minimum diameter wired	2	5	7	7	9	12	
Crushed stone	3½	8½	11	9	12	16	
Tamped earth	7	18	25	20	27	40	

NOTE.—Protective thickness given is for a single hit only.

TABLE XXIII.—Thickness required for protection against single shots by direct-fire weapons

Materials	Thickness required for protection against single shots by direct-fire weapons						Remarks
	Small-arms and MG (7.92-mm) fire at 100 yards ¹	20-mm AT fire at 200 yards	37-mm AT fire at 400 yards	50-mm AT fire at 400 yards	75-mm direct fire 500-1,000 yards	88-mm direct fire 500-1,000 yards	
Solid walls: ²							
Brick masonry	1½	2½	5	4	4½	6½	Ordinary concrete walls.
Concrete (not reinforced) ³	1	2	3½	4	4	5	Structurally reinforced.
Concrete (reinforced) ³	½	1½	3	3½	4	5	

Stone masonry	do	1	1½	2½	3½	4½	5	These figures can be taken as guide only.
Wood	do	2	3	4				
Timber	do	3	5					
Walls of loose materials packed between boards: ²								
Brick rubble	feet	1	2	2½	5	6		Add 100 percent if wet.
Clay (dry)	do	3	4					Add 50 percent if wet.
Loam (dry)	do	2	3	4				
Gravel, small stones	do	1	2	2½	5	6		
Sand (dry)	do	1	2	2½	5	6		Add 100 percent if wet.
Sandbags filled with: ⁴								
Brick rubble	inches	20	30	30	60	70		Add 100 percent if wet.
Clay (dry)	do	40	60					Add 50 percent if wet.
Loam (dry)	do	30	50	60				
Gravel, small stones	do	20	30	30	60	70		
Sand (dry)	do	20	30	30	60	70		Add 100 percent if wet.
Loose parapets of: ³								
Clay	feet	3½	5					Add 100 percent if wet.
Loam	do	3	4	5				Add 50 percent if wet.
Sand	do	2	3	4				Add 100 percent if wet.

¹ One burst of five shots.

² Thickness given to the nearest half foot.

³ For 3,000 pounds per square inch concrete.

⁴ Thickness for walls made of sandbags given in multiples of filled bag widths (10 inches).

NOTE.—Protective thickness given is for a single shot only. Where direct-fire weapons are able to get five or six hits in the same area, the required protective thickness is approximately twice that indicated.

TABLE XXIV. Thickness of materials required to protect against penetration of fragments from projectiles and bombs exploding at a distance of 50 feet

Material	Thickness measured in—	High explosive shell				General-purpose bomb			
		75-mm	105-mm	155-mm	100-pound	250-pound	500-pound	1,000-pound	
Solid walls:	Inches								
Brick masonry	-----	4	6	8	8	10	13	17	
Concrete (plain)	-----	4	5	6	8	11	15	18	
Concrete (reinforced)	-----	3	4	5	7	9	12	15	
Timber	-----	8	10	14	15	18	24	30	
Walls of loose material packed between boards:									
Brick rubble	-----	9	10	12	18	24	28	30	
Gravel, small stones	-----	9	10	12	18	24	28	30	
Earth	-----	15	18	24	24	30	-----	-----	
Sandbags filled with: ¹	Inches								
Brick rubble	-----	10	10	20	20	20	30	40	
Gravel, small stones	-----	10	10	20	20	20	30	40	
Sand	-----	10	10	20	30	30	40	40	
Earth	-----	20	20	30	30	40	40	50	
Parapets of: ²	Feet								
Sand (dry)	-----	1	1½	2	2	3	3	4	
Earth (dry)	-----	2	3	4	3	4	5	-----	

¹ Figures given in multiples of width or thickness of sandbags.² Figures given to nearest half foot.

APPENDIX III

CONCRETE MACHINE-GUN EMPLACEMENT

1. GENERAL. This appendix describes a square-type, concrete pill box which has been used in the theatre of operations. (See fig. 111.) It is simple, relatively easy to construct, and may be modified to meet local requirements.

2. PROTECTION. a. The concrete pill box (fig. 111) protects against bomb splinters, shell fragments, and small-arms fire.

b. If steel plate is available, embrasures not being used are covered by plates bolted into place. Otherwise, sandbags may be used to give partial protection.

3. CONSTRUCTION. Figure 111① ②, and ③ show details of construction. Table XXV gives the bill of materials required.

4. ARMAMENT. Either the light or heavy caliber .30 machine gun may be used in this emplacement. However, the light one is preferred because its general size and shape permit a smaller embrasure. Figure 111④ shows details of a pintle mount for the caliber .30 light machine gun. Field units with shop facilities easily can make the necessary parts. Figure 111⑤ shows an alternative embrasure design for the caliber .30 heavy machine gun. This design permits use of

the regular gun mount. One tripod leg projects through the emplacement wall.

TABLE XXV. *Bill of materials for square-type concrete pill box (fig. 111)*

Item	Quantity
Concrete:	
(Cement)-----	11 cubic yards (66 sacks).
(Sand)-----	5 cubic yards.
(Stone)-----	10 cubic yards.
Reinforcement:	
R. R. rails (30-pound) 9 feet 6 inches long--	4.
Bars, ½ inch round, 9 feet 6 inches long---	54 pieces.
Bars, ½ inch round, 6 feet 6 inches long---	44 pieces.
Bolts, machine, squarehead, with nut and 2 washers, ½ inch round, 12 inches long.	20.

*If leg-through-wall mounts are used, the following items are required:

Bolts, machine, squarehead, with nut and 2 washers ½ inch round, 12 inches long-----	6
Steel plate, 3 inches by ½ inch by 3 inches-----	2
Steel plate, 4 inches by ½ inch by 1 foot 8 inches-----	2

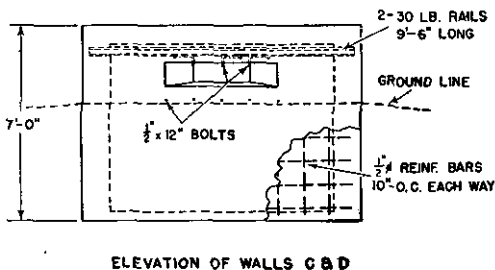
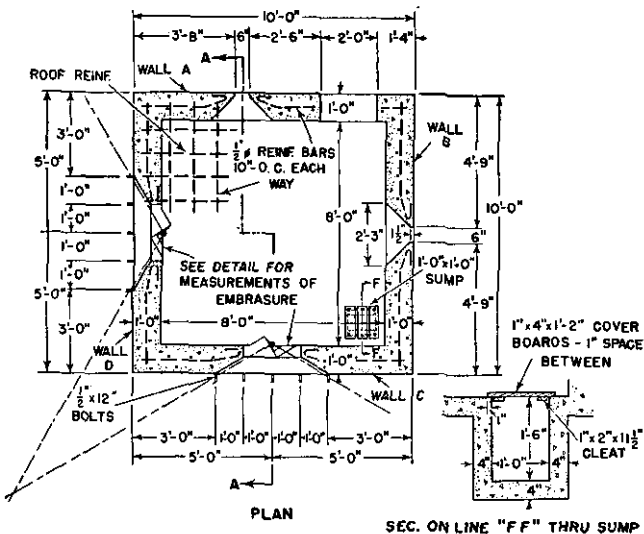

EMBASUREMENT SHOWN IS FOR CAL. 30 LIGHT MG. OTHER TYPES MAY BE USED.
NUMBER OF EMBASUREMENTS CAN BE VARIED.

① Plan and elevation.

Figure 111. Square-type concrete pill box.

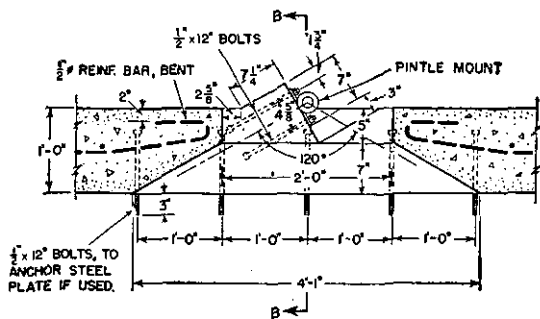
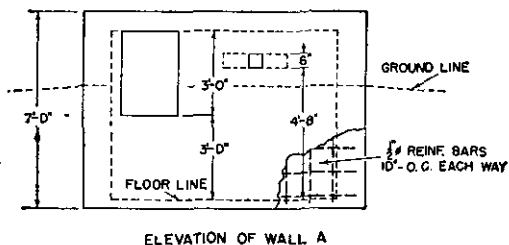
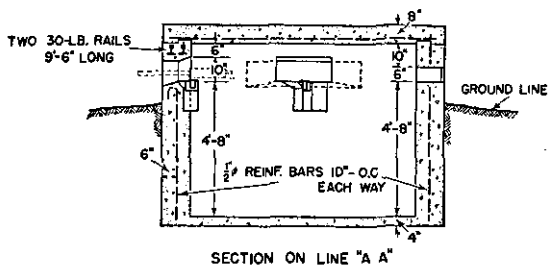

② Section AA, elevation and embrasure details.

Figure 111—Continued.

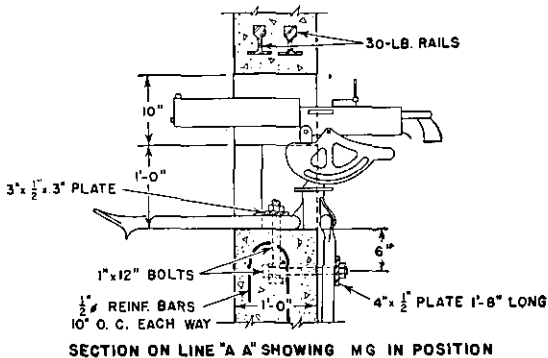
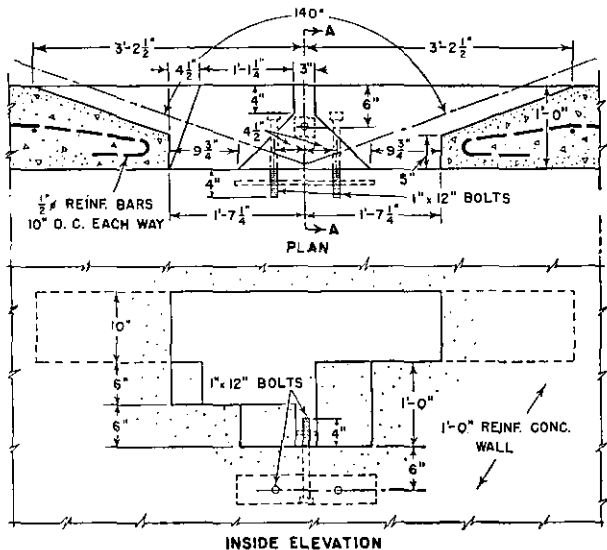

⑤ Alternative embrasure, leg-through-wall mount.

Figure 111—Continued.

APPENDIX IV

40-MM ANTI-AIRCRAFT TOWER

1. PURPOSE. The purpose of the 40-mm anti-aircraft tower (fig. 112 ①) is to place small-caliber (40-mm and under) anti-aircraft guns at a height from which they may fire effectively at all positive angles of elevation through a traverse of 290°. The installation sites are so chosen that the weapons grouped for defense of an area are mutually supporting. For details for the 40-mm gun tower, see figure 112 ②, ③, ④, ⑤, and ⑥, and table XXVI; for the director tower, see figures 113 and 114 ①, ②, and ③, and table XXVII; and for the observation tower, see figure 115 ① and ②, and table XXVIII.

2. DESIGN. a. The structure is composed of two separate towers 2 feet apart. The director, which is on one tower, is not affected by vibrations set up when the gun is fired on the other. A cantilever type footbridge extends from the director tower to 2 inches above the gun tower.

b. The structure is designed to support its own weight plus the 40-mm gun and mount, caliber .50 machine gun and mount, director, crew, ammunition, and the vibration caused by firing the 40-mm gun. The power plant is placed on the ground.

c. The concrete footings are designed to carry the load on soils with a bearing power of 1,000 pounds or more per square foot. When soil has less bearing

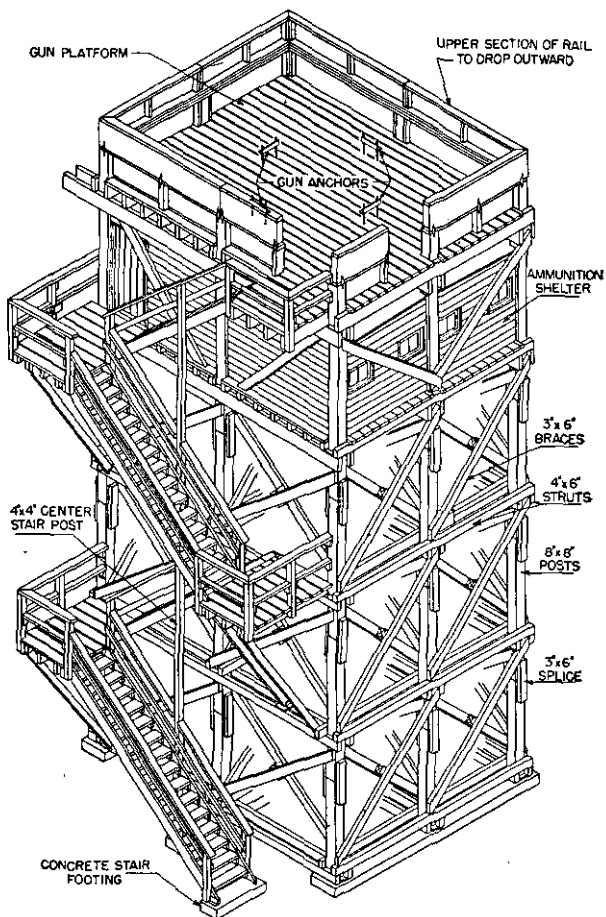

① Isometric view.

FIGURE 112. Forty-foot towers for 40-mm antiaircraft gun.

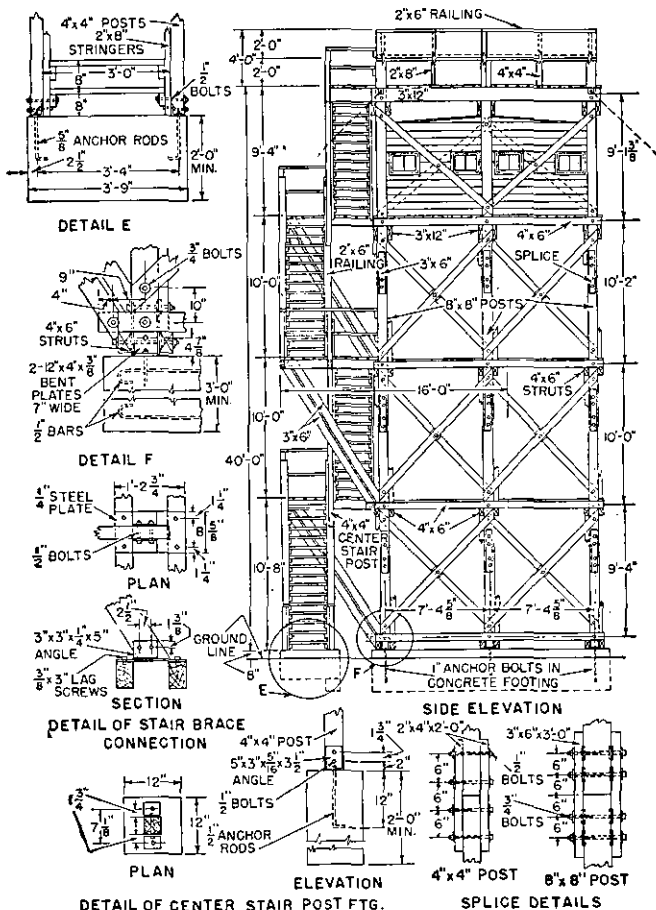

③ Side elevation and details.

Figure 112—Continued.

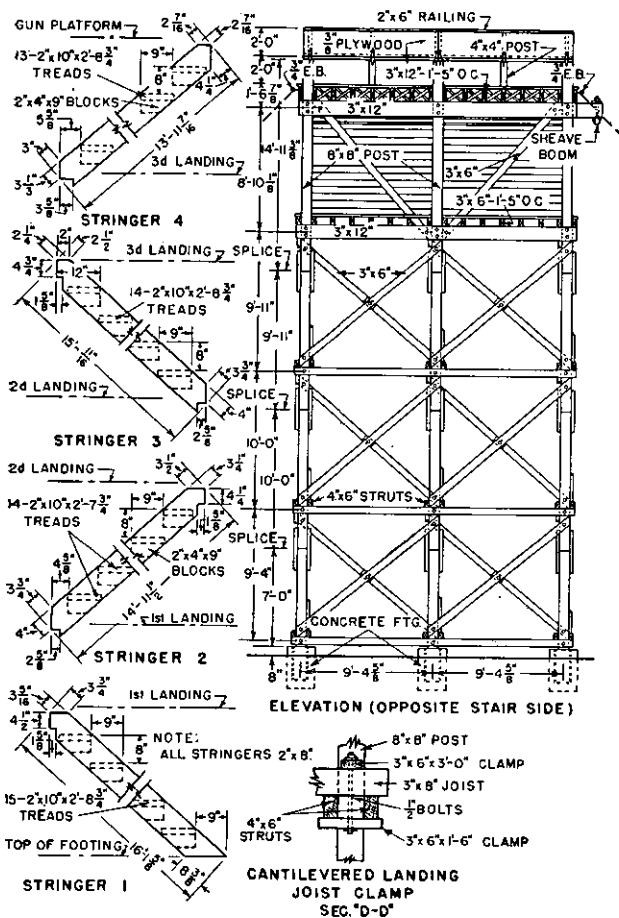

④ Elevation (opposite stair side) and details.

Figure 112—Continued.

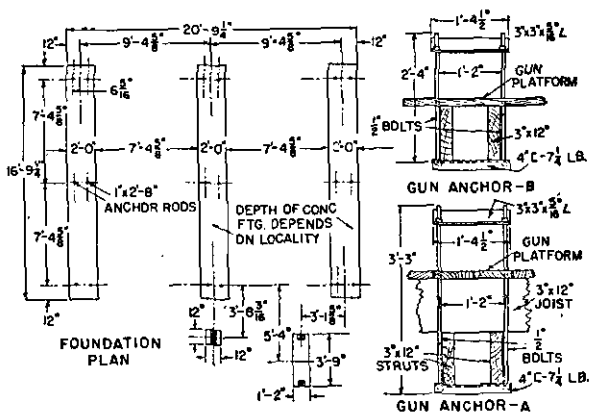
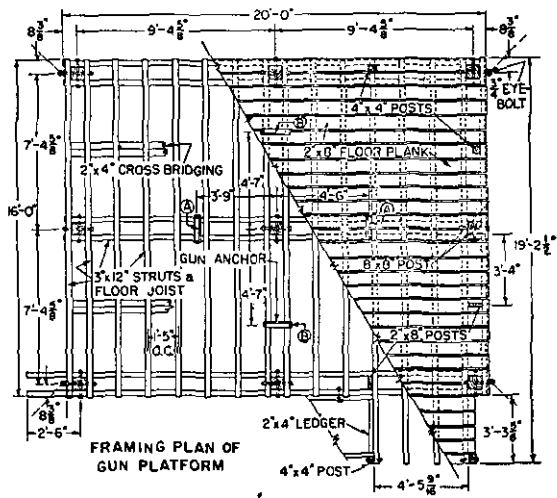

⑤ Foundation plan and framing plan of gun platform.

Figure 112—Continued.

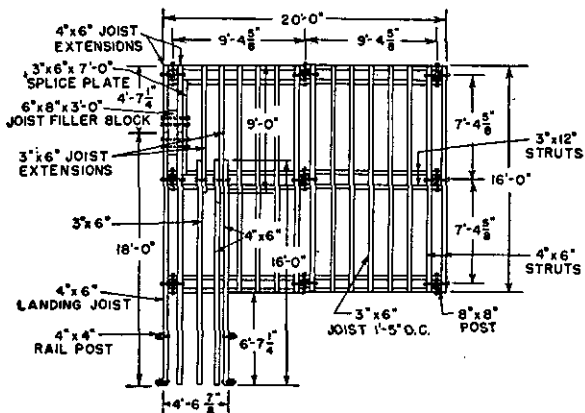

FRAMING PLAN OF THIRD LANDING

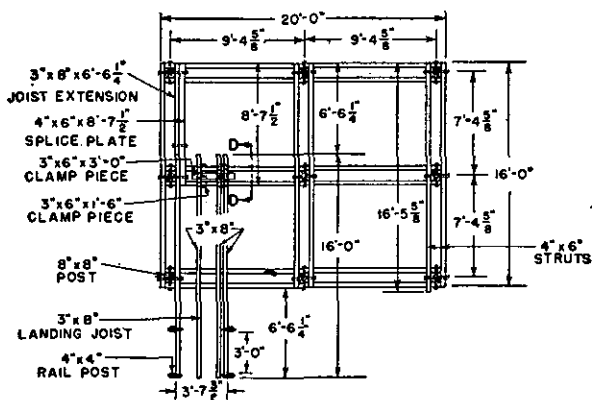

FRAMING PLAN OF FIRST LANDING
 SECOND LANDING SIMILAR—REVERSED

⑧ Framing plan for stair landing.

Figure 112—Continued.

TABLE XXVI. Bill of materials for 40-mm antiaircraft gun tower
Lumber cutting list

Size	Length	Make	Cut from—	Order	Board feet	Description
8" x 8"	7' 0"	9	14' 0"	5	373	Posts (lower panel).
Do.	10' 0"	9	10' 0"	9	480	Posts (second panel from bottom).
Do.	9' 11"	9	10' 0"	9	480	Posts (third panel from bottom).
Do.	14' 11 ³ / ₄ "	8	16' 0"	8	683	Posts (fourth panel from bottom).
Do.	12' 11 ³ / ₄ "	1	14' 0"	1	75	Do.
6" x 8"	3' 0"	1	4' 0"	1	16	See framing plan.
6" x 8"	0' 9"	36	14' 0"	2	128	Brace filler blocks.
3" x 6"	3' 0"	2	8' 0"	1	12	Clamp pieces.
4" x 6"	16' 5 ⁵ / ₈ "	3	18' 0"	3	108	Struts.
Do.	20' 0"	18	20' 0"	18	720	Do.
Do.	16' 0"	19	16' 0"	19	608	Do.
Do.	8' 7 ¹ / ₂ "	2	10' 0"	2	40	Splice plates (first and second landing).
Do.	4' 7 ¹ / ₄ "	2	10' 0"	1	20	Extension to third landing joist.
Do.	18' 0"	2	18' 0"	2	72	Joists (third landing).
4" x 4"	7' 0"	1	8' 0"	1	11	Center stair post (first length).
Do.	10' 0"	1	10' 0"	1	10	Center stair post (second length).
Do.	9' 11"	1	10' 0"	1	10	Center stair post (third length).
Do.	10' 7"	1	12' 0"	1	21	Center stair post (fourth length).
Do.	4' 1 ¹ / ₂ "	8	14' 0"	3	56	Stair post (first and second landing).
Do.	3' 6"	2	8' 0"	1	11	Stair post (ground level).
Do.	3' 11 ⁵ / ₈ "	4	16' 0"	1	22	Stair post (third landing).
Do.	3' 6 ¹ / ₂ "	3	12' 0"	1	16	Stair post (top landing).
Do.	2' 0"	6	12' 0"	1	16	Platform posts.

TABLE XXVI. Bill of materials for 40-mm anti-aircraft gun tower—Continued

Lumber cutting list—Continued

Size	Length	Make	Cut from—	Order	Board feet	Description
3" x 12"-----	16' 0"-----	12	16' 0"-----	12	576	Platform joist.
Do-----	19' 2 ⁵ / ₈ "-----	4	20' 0"-----	4	240	Do.
Do-----	20' 0"-----	10	20' 0"-----	10	600	Struts.
Do-----	21' 10 ³ / ₄ "-----	2	22' 0"-----	2	132	Do.
3" x 8"-----	16' 0"-----	8	16' 0"-----	8	256	Joist (first and second landing).
Do-----	6' 6 ¹ / ₄ "-----	2	14' 0"-----	1	28	Extension to first and second landing joist.
3" x 6"-----	11' 7 ¹ / ₄ "-----	12	12' 0"-----	12	216	Main braces.
Do-----	13' 2"-----	11	14' 0"-----	11	231	Do.
Do-----	11' 11 ⁵ / ₈ "-----	12	12' 0"-----	12	216	Do.
3" x 6"-----	13' 4 ⁵ / ₈ "-----	11	14' 0"-----	11	231	Do.
Do-----	11' 5 ³ / ₄ "-----	12	12' 0"-----	12	216	Do.
Do-----	12' 11 ¹ / ₂ "-----	12	14' 0"-----	12	252	Do.
Do-----	13' 3 ¹ / ₄ "-----	1	14' 0"-----	1	21	Braces (second panel, top).
Do-----	13' 3 ¹ / ₄ "-----	1	14' 0"-----	1	21	Braces (second panel, bottom).
Do-----	3' 0"-----	54	12' 0"-----	14	252	Splice plates (main posts).
Do-----	12' 4"-----	1	14' 0"-----	1	21	Landing brace (first landing).
Do-----	12' 6 ⁵ / ₈ "-----	1	14' 0"-----	1	21	Do.
Do-----	12' 9 ¹ / ₂ "-----	1	14' 0"-----	1	21	Landing brace (second landing).
Do-----	12' 11 ¹ / ₂ "-----	1	14' 0"-----	1	21	Do.
Do-----	13' 2 ⁷ / ₈ "-----	1	14' 0"-----	1	21	Landing brace (third landing).
Do-----	13' 2"-----	1	14' 0"-----	1	21	Do.
Do-----	10' 0"-----	2	10' 0"-----	2	30	Extension to third landing joist.
Do-----	7' 0"-----	1	8' 0"-----	1	12	Splice plate (third landing).

3" x 6"	16' 0"	9	16' 0"	9	216	Joists (Shelter No. 1).
Do	19' 0"	9	20' 0"	9	270	Joists (Shelter No. 2).
Do	12' 6 $\frac{5}{8}$ "	4	14' 0"	4	84	Side braces (Shelter No. 1).
Do	10' 8 $\frac{3}{4}$ "	4	12' 0"	4	72	End braces.
Do	10' 4 $\frac{1}{2}$ "	4	12' 0"	4	72	Do.
Do	1' 6"	4	6' 0"	1	9	Clamp pieces.
2" x 10"	2' 8 $\frac{3}{4}$ "	42	14' 0"	9	201	Stair treads.
Do	2' 7 $\frac{3}{4}$ "	14	12' 0"	4	77	Do.
2" x 8"	16' 1 $\frac{1}{2}$ "	2	18' 0"	2	48	Stringers (to first landing).
Do	14' 11 $\frac{1}{2}$ "	2	16' 0"	2	48	Stringers (to second landing).
Do	15' 3 $\frac{1}{2}$ "	2	16' 0"	2	43	Stringers (to third landing).
Do	13' 11 $\frac{1}{2}$ "	2	14' 0"	2	38	Stringers (to top landing).
Do	4' 2"	20	18' 0"	5	117	Flooring (first and second landing).
Do	5' 1 $\frac{1}{8}$ "	10	12' 0"	5	80	Flooring (third landing).
Do	4' 11"	6	10' 0"	3	40	Stair landing (gun platform).
Do	14' 0"	1	14' 0"	1	18	Middle rail (platform rail).
Do	19' 4 $\frac{3}{4}$ "	1	20' 0"	1	26	Do.
Do	15' 4 $\frac{3}{4}$ "	1	16' 0"	1	21	Do.
Do	8' 1 $\frac{1}{8}$ "	1	10' 0"	1	13	Do.
Do	4' 5 $\frac{1}{8}$ "	1	6' 0"	1	8	Do.
Do	20' 0"	25	20' 0"	25	650	Flooring (gun platform).
Do	3' 6"	2	10' 0"	1	13	Posts (platform rail).
2" x 6"	4' 7 $\frac{1}{2}$ "	2	10' 0"	1	10	Top rail (gun platform).
Do	9' 9 $\frac{1}{4}$ "	6	10' 0"	6	60	Do.
Do	7' 9 $\frac{1}{4}$ "	4	16' 0"	2	32	Do.
Do	8' 1"	2	10' 0"	2	20	Do.
Do	4' 1 $\frac{1}{2}$ "	2	10' 0"	1	10	Do.
Do	To cut.	1	16' 0"	1	16	Top rail (stair to first landing).
Do	do	1	16' 0"	1	16	Do.
Do	do	1	14' 0"	1	14	Top rail (stair to second landing).

TABLE XXVI. *Bill of materials for 40-mm antiaircraft gun tower—Continued*

Hardware list—Continued

Item	Size	Quantity
Galvanized strap hinges	8''	20
Pl. washers (square cut or standard O. G.)	3'' x 3'' x $\frac{3}{16}$ ''	433
Nails	20d	10 lb.
Do	16d	15 lb.
Standard double wood block and fall.	300-lb. capacity	1
Siemens-Martin 7-strand galvanized wire.	$\frac{3}{8}$ '' ϕ	228 ft.
Split ring connectors	4'' ϕ	592
Shear plates (mal. iron)	4''	54

Footing and deadmen materials list

Item	Quantity
Cement	20 barrels.
Sand	7 cubic yards.
Gravel ($1\frac{1}{2}$ '' maximum)	10 cubic yards.
Reinforcing rods, $\frac{1}{2}$ '' x 17' 6'' footings	12.
Reinforcing rods, $\frac{1}{2}$ '' x 5' 8'' deadmen	20.
Reinforcing ties, $\frac{1}{4}$ '' x 3' 0'', deadmen	16.
Channels for deadmen, 3'', 5 lb. x 2' 0''	4.
Galvanized eyebolts, $\frac{5}{8}$ '' x 7' 6''	4.

power, the footings must be redesigned. The elevation of the footings of both towers is the same regardless of ground features at the site. Footings are poured long enough beforehand to allow concrete to acquire full strength before erection of the tower starts. This time may be lessened appreciably by use of high early strength cement. (For information on bearing power and footing design see FM 5-35.)

d. The effective height of the gun tower is 40 feet and of the director tower, 41 feet. The gun tower, built in 10-foot vertical sections, may be lowered by omitting one or both middle sections. The director tower, similarly designed, may be lowered in the same way.

e. The necessary stability for the gun is obtained by using split-ring connectors, blocking between cross-bracing, and guy lines.

f. The permanent ammunition shelter (figure 116 and table XXIX) is placed on the deck immediately under the gun platform. The sides are covered with 1-inch tongue-and-groove sheathing and tarpaper to protect the ammunition from the weather. An ammunition hoist may be provided as a permanent part of the tower by extending the two outside stringers on the side of the stairway and attaching a block near the end.

g. An alternative design of ammunition shelter (fig. 117 ① and ② and table XXX) is smaller than the regular shelter. Because it is smaller and has a simpler design it is easier to erect. It can be built within the tower in place of the other shelter, or on the ground as an extra shelter.

3. CONSTRUCTION. There are two common methods of constructing the towers:

a. If hoisting machinery is not available, erect the director tower first and use it as a scaffold to hoist the larger members of the gun tower.

b. If hoisting machinery is available, erect towers simultaneously, piece by piece.

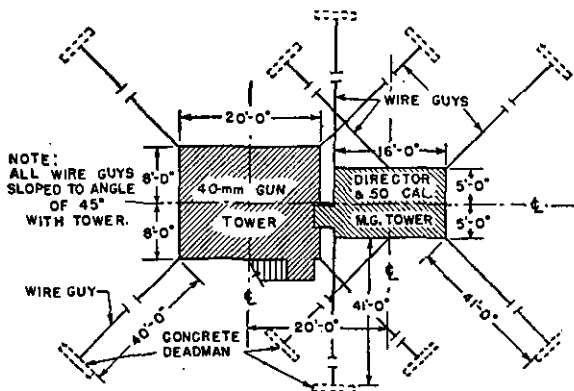

SCHEMATIC PLAN SHOWING RELATIVE POSITION OF TOWERS, GUYS, AND DEADMEN

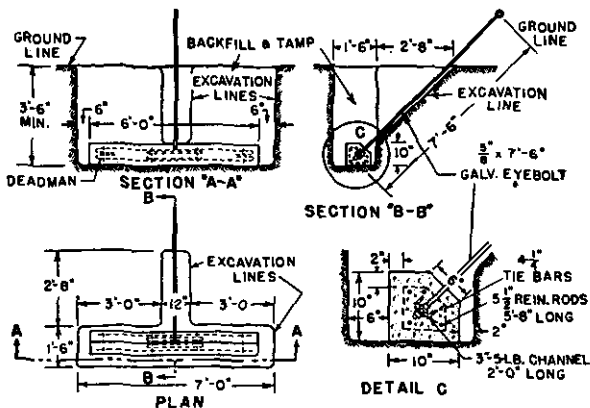

DETAILS OF TYPICAL DEADMAN (BEFORE BACKFILLING)

FIGURE 113. Schematic plan of 40-mm gun tower, adjacent machine-gun tower, and details of typical deadman.

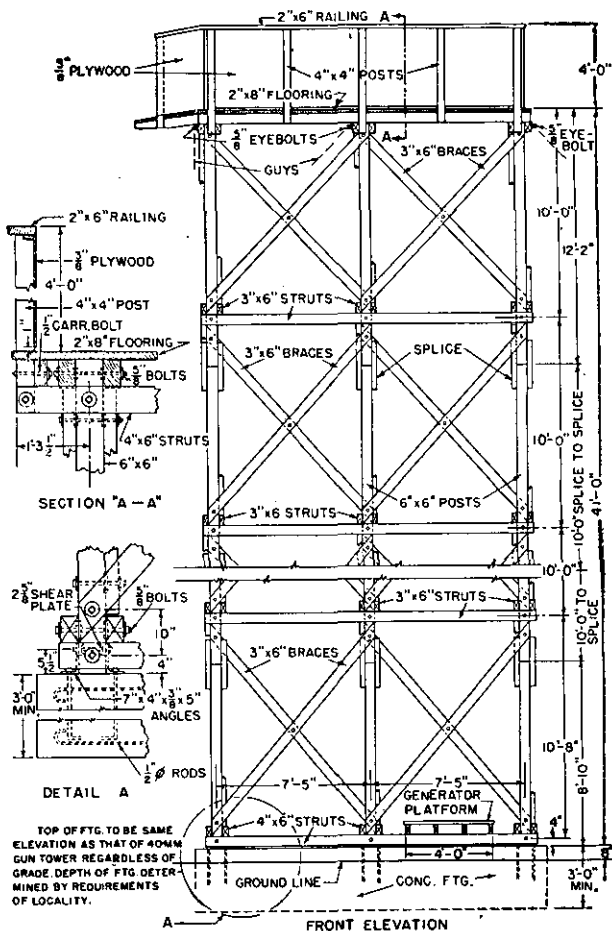

① Front elevation and details.

FIGURE 114. Forty-one-foot tower for director and caliber .50 machine gun.

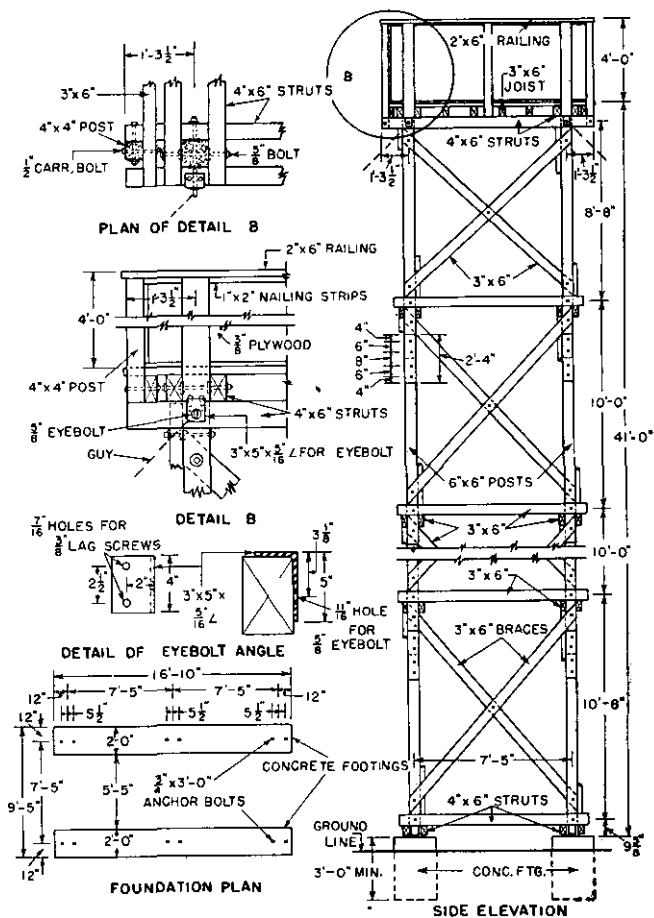

② Side elevation and details.

Figure 114—Continued.

TABLE XXVII. Bill of materials for director tower
Lumber cutting list

Description	Size	Length	Make	Cut from—	Order	Board feet
Posts, 1st length	6" x 6"	8' 10"	6	18' 0"	3	162
Posts, 2d and 3d length	do	10' 0"	12	10' 0"	12	360
Posts, 4th length	do	12' 0"	2	12' 0"	2	72
Do	do	15' 10 ³ / ₈ "	4	16' 0"	4	192
Brace filler blocks	do	0' 9"	28	12' 0"	2	72
Struts	4" x 6"	16' 0"	8	16' 0"	8	256
Do	do	9' 0"	6	18' 0"	3	96
Do	do	10' 0"	6	18' 0"	6	120
Posts, director platform	4' x 4"	4' 11 ¹ / ₄ "	8	10' 0"	4	54
Do	do	4' 6"	4	10' 0"	2	27
Braces, 1st panel	3' x 6"	12' 8"	14	14' 0"	14	294
Braces, 2d and 3d panel	do	12' 4"	28	14' 0"	28	588
Braces, 4th panel	do	12' 0"	14	12' 0"	14	216
Struts	do	16' 0"	12	16' 0"	12	288
Do	do	9' 0"	18	18' 0"	9	243
Do	do	16' 0"	6	16' 0"	6	144
Splice plates	do	2' 4"	36	14' 0"	6	126
Flooring, bridge	2' x 8"	3' 1"	6	10' 0"	2	27
Flooring, director platform	do	10' 0"	25	10' 0"	25	333
Flooring, generator platform	2' x 6'	4' 2"	12	14' 0"	4	56
Joists, generator platform	do	9' 0"	4	10' 0"	4	40
Joists, bridge	do	To cut	3	18' 0"	3	48

Rails, platform	do.	15' 6"	2	16' 0"	2	32
Do	do.	10' 1"	1	12' 0"	1	12
Do	do.	To cut.	2	8' 0"	1	8
Filler blocks, bridge platform	do.	0' 4"	2	Scrap		
Filler blocks, director platform	do.	0' 6"	4	do.		
Posts, bridge rail	2" x 4"	4' 4"	2	} 14' 0"	1	9
Rail, bridge	do.	2' 6"	2			
Do	do.	To cut.	2	6' 0"	1	4
Nailing strips	1" x 2"	do.	Strip	10' 0"	8	13
	3/8"	Plywood	—224 square feet.			

TABLE XXVII. *Bill of materials for director tower—Continued**Hardware list*

Item	Size	Quantity
Carriage bolts complete with nuts and washers.	$\frac{1}{2}$ " ϕ x 9" -----	12
Do.....	$\frac{1}{2}$ " ϕ x 8" -----	12
Do.....	$\frac{1}{2}$ " ϕ x 6" -----	4
Machine bolts with nuts	$\frac{5}{8}$ " ϕ x 1'3" -----	6
Do.....	$\frac{5}{8}$ " ϕ x 1'2" -----	12
Do.....	$\frac{5}{8}$ " ϕ x 12" -----	160
Do.....	$\frac{5}{8}$ " ϕ x 9 $\frac{1}{2}$ " -----	80
Eye bolts.....	$\frac{5}{8}$ " ϕ x 1'2" -----	6
Wire nails.....	6d -----	5 lb.
Do.....	16d -----	5 lb.
Anchor bolts.....	$\frac{3}{4}$ " ϕ x 3'0" -----	12
Angles.....	4' x 7' x $\frac{3}{8}$ " x 5' long -----	12
Do.....	3' x 5' x $\frac{5}{16}$ " x 4' long -----	4
Split ring connectors.....	2 $\frac{1}{2}$ " ϕ -----	360
Shear plate connectors.....	2 $\frac{5}{8}$ " -----	12
Plate washers (square or standard O. G.).	$\frac{3}{16}$ " ϕ x 3" -----	524
Guy clamps.....	$\frac{3}{8}$ " -----	24
Turnbuckles.....	$\frac{1}{2}$ " shackle ends -----	6
Thimbles.....	$\frac{3}{8}$ " -----	12
7-strand galvanized wire.....	$\frac{3}{8}$ " ϕ -----	360 ft.

Footings and deadmen materials list

Item	Quantity
Cement.....	10 barrels.
Sand.....	5 cubic yards.
Gravel (1 $\frac{1}{2}$ " maximum).....	6 cubic yards.
Reinforcing rods, $\frac{1}{2}$ " ϕ x 17' 6" (ftgs.).....	8.
Reinforcing rods, $\frac{1}{2}$ " ϕ x 5' 8" (deadmen).....	30.
Reinforcing ties, $\frac{1}{4}$ " ϕ x 3' 0" (deadmen).....	24.
Channels for deadmen, 3", 5-pound x 2' 0".....	6.
Galvanized eyebolts, $\frac{5}{8}$ " ϕ x 7' 6".....	6.

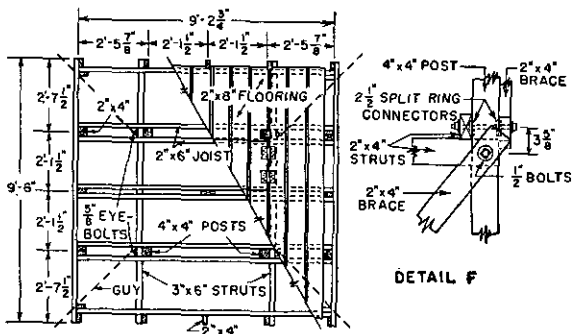

FRAMING PLAN OF PLATFORM

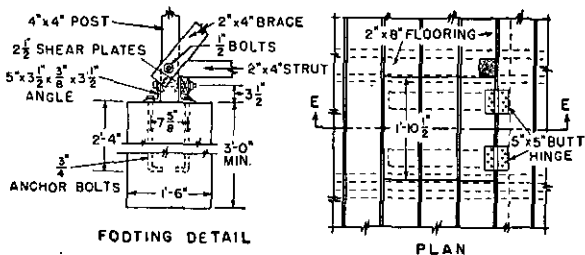

FOOTING DETAIL

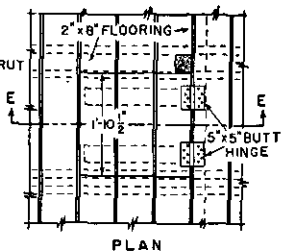

PLAN

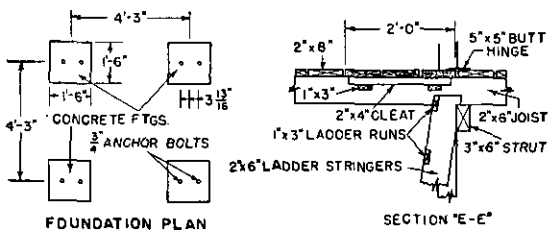

FOUNDATION PLAN

SECTION "E-E"

DETAILS OF TRAP DOOR

① Plan and details.

FIGURE 115. Thirty-one-foot observation tower.

TABLE XXVIII. Bill of materials for observation tower
Lumber cutting list

Size	Length	Make	Cut from—	Or- der	Board feet	Description
4" x 4"	15' 7 $\frac{1}{2}$ "	4	16' 0"	4	86	Post (first length).
Do	12' 0"	4	12' 0"	4	64	Post (second length).
Do	10' 7 $\frac{1}{8}$ "	4	12' 0"	4	64	Post (third length).
3" x 6"	9' 6"	2	10' 0"	2	30	Strut, platform.
2" x 4"	4' 6"	29	14' 0"	10	94	Struts.
Do	8' 0"	16	16' 0"	8	86	Braces, first, second, third, and fourth panels.
Do	7' 3"	4	16' 0"	2	22	Braces, fifth panel.
Do	2' 4"	16	10' 0"	4	27	Splice plates.
Do	4' 11 $\frac{1}{4}$ "	4	10' 0"	2	14	Rail posts.
Do	4' 5 $\frac{1}{2}$ "	12	14' 0"	4	38	Do.
Do	9' 8 $\frac{3}{4}$ "	8	10' 0"	8	54	Ceiling joist, platform cover.
Do	1' 10"	2	12' 0"	1	8	{Cleats, for trap door.
Do	0' 6"	4				{Filler blocks, rail post.
Do	2' 10"	1	12' 0"	1	8	{Railing.
Do	0' 7"	4				{Scabs, platform rail.
Do	9' 8 $\frac{3}{4}$ "	2	10' 0"	2	14	Joist headers, platform cover.
2" x 6"	9' 2 $\frac{3}{4}$ "	8	10' 0"	8	80	Joist, platform.
Do	9' 6"	2	10' 0"	2	20	{Joist headers, platform.
Do	0' 6"	1				{Filler block, platform joist.
Do	10' 0"	2	10' 0"	2	20	Struts, platform cover.
Do	12' 0"	2	12' 0"	2	24	Stringers, ladder to second landing.

TABLE XXVIII. Bill of materials for observation tower—Continued

Lumber cutting list—Continued

Size	Length	Make	Cut from—	Order	Board feet	Description
2" x 6"	18' 0"	2	18' 0"	2	36	Stringers, ladder to platform.
Do	9' 6"	2	10' 0"	2	20	
Do	8' 9"	2	10' 0"	2	20	Railing, platform.
2" x 8"	8' 10 ³ / ₄ "	13	18' 0"	7	164	Do.
Do	4' 0"	3	12' 0"	1	16	Flooring, platform.
Do	2' 2"	3	8' 0"	1	11	Flooring, first landing.
1" x 6"	10' 0"	22	10' 0"	22	110	Flooring, second landing.
1" x 3"	1' 7 ⁵ / ₈ "	34	10' 0"	22	110	Roofing, platform cover.
1" x 3"	1' 6"	2	10' 0"			6
3/8"	Plywood—144 square feet.					

TABLE XXVIII. *Bill of materials for observation tower—Con.**Hardware list*

Item	Size	Quantity
Carriage bolts complete w/nuts and washers.	$\frac{1}{2}$ " ϕ x $6\frac{1}{2}$ "	4
Do.....	$\frac{1}{2}$ " ϕ x 6 "	6
Do.....	$\frac{1}{2}$ " ϕ x $5\frac{1}{2}$ "	8
Do.....	$\frac{3}{4}$ " ϕ x $4\frac{1}{2}$ "	16
Do.....	$\frac{1}{4}$ " ϕ x 7 "	4
Machine bolts complete w/nuts and washers.	$\frac{3}{4}$ " ϕ x 9 "	2
Do.....	$\frac{3}{4}$ " ϕ x $7\frac{1}{2}$ "	2
Do.....	$\frac{1}{2}$ " ϕ x 8 "	74
Do.....	$\frac{1}{2}$ " ϕ x $6\frac{1}{2}$ "	6
Anchor bolts.....	$\frac{3}{4}$ " ϕ x $2'8"$	8
Eyebolts.....	$\frac{5}{8}$ " ϕ x 8 "	4
Split rings.....	$2\frac{1}{2}$ " ϕ	150
Shear plates.....	$2\frac{5}{8}$ "	14
Angles.....	$3\frac{1}{2}$ " x 5 " x $\frac{3}{8}$ " x $3\frac{1}{2}$ " long.	8
Do.....	$3\frac{1}{2}$ " x 5 " x $\frac{3}{8}$ " x 4 " long.	4
Butt hinges.....	5 " x 5 "	2
Roll roofing.....	36 " wide/108 square feet.	1 roll
Lag screws.....	$\frac{1}{4}$ " ϕ x 3 "	8
Nails.....	$16d$	10 lb.
Do.....	$10d$	10 lb.
Do.....	$8d$	5 lb.
Roof tacks.....	5-pound box	1 box
Turnbuckles.....	$\frac{1}{2}$ " shackle ends	4
Thimbles.....	$\frac{5}{16}$ "	8
Wire clips.....	$\frac{3}{16}$ "	16
7-strand galvanized wire.....	$\frac{3}{8}$ " ϕ	180 ft.

Footing and deadmen materials list

Item	Quantity
Cement.....	0.74 barrel.
Sand.....	0.23 cubic yard.
Gravel ($1\frac{1}{2}$ " maximum).....	0.45 cubic yard.
Reinforcing rods, $\frac{1}{2}$ " ϕ x $5'8"$, deadmen.....	20.
Reinforcing ties, $\frac{1}{4}$ " ϕ x $3'0"$, deadmen.....	16.
Channels for deadmen, $3'5$ pounds x $2'0"$	4.
Galvanized eyebolts, $\frac{5}{8}$ " ϕ x $7'6"$	4.

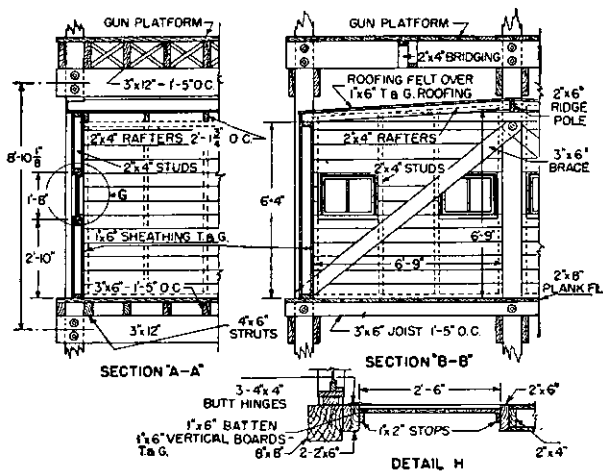
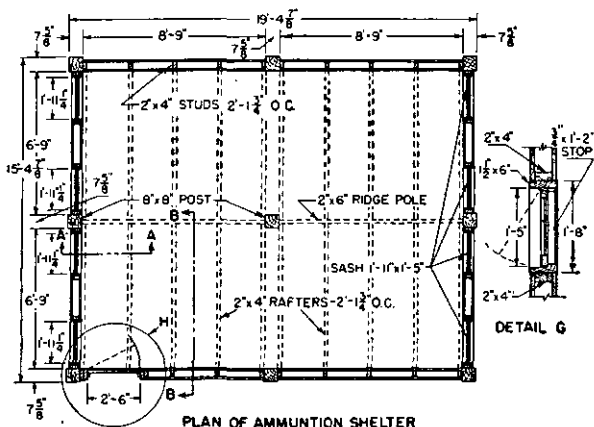

FIGURE 116. Permanent ammunition shelter for 40-mm antiaircraft gun tower.

TABLE XXIX. Bill of materials for permanent ammunition shelter
Lumber cutting list

Size	Length	Make	Cut from—	Order	Board feet	Description
2" x 8"	18' 9"	28	20' 0"	28	728	Flooring.
2" x 6"	0' 7½"	2	} 10' 0"	2	20	{ Blocks at center post.
Do	8' 9⅞"	2		Do	40	{ Ridge board.
Do	2' 2½"	16	10' 0"	4	24	Door lintel.
Do	6' 0¾"	3	8' 0"	3	48	Door jambs.
2" by 4"	8' 9"	8	18' 0"	4	37	Plates, floor.
Do	6' 9"	8	14' 0"	4	92	Do.
Do	6' 0¾"	19	14' 0"	10	19	Studs, am. shelter.
Do	6' 6"	4	14' 0"	2	19	End studs, am. shelter.
Do	6' 8½"	4	14' 0"	2	19	Do.
Do	6' 9½"	4	14' 0"	2	37	Do.
Do	6' 11¼"	8	14' 0"	4	24	Roof rafter braces.
Do	2' 0¼"	16	18' 0"	2	12	Window headers.
Do	2' 2½"	8	18' 0"	1	107	Rafters.
Do	7' 6"	20	16' 0"	10	340	Roof sheathing.
1" x 6"	19' 1"	34	20' 0"	34	726	
1" x 6"	T. & G				10	Ties.
1" x 4"	14' 0"	2	14' 0"	2	21	Door sheathing.
1" x 6"	6' 0¼"	6	14' 0"	3	5	Bracing and crosspieces.
1" x 4"	To cut		14' 0"	1	14	Door and rebate stops.
1" x 2"	do		10' 0"	8		

1" x 6" Tongue and groove sheathing—726 board feet.
8-std. 2-light sash, 9" x 12" glass (1' 5" x 1' 11").

TABLE XXIX. *Bill of materials for permanent ammunition shelter—Continued*

Hardware list

Item	Size	Quantity
Butt hinges	3'' x 3''	16
Do	4'' x 4''	3
Galvanized roofing nails		5 lb.
Nails	20d	10 lb.
Do	16d	10 lb.
Do	8d	20 lb.
Thumb latch	5½''	1
Galvanized hooks and eyes	2½'' screw type	16
Roofing felt, 45-pound	36'' rolls	4 rolls

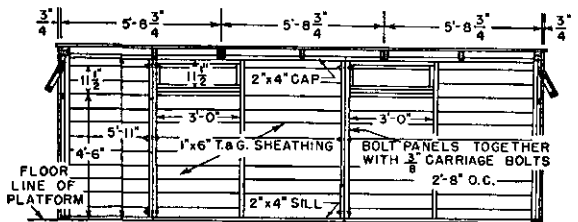

SECTION "A-A"

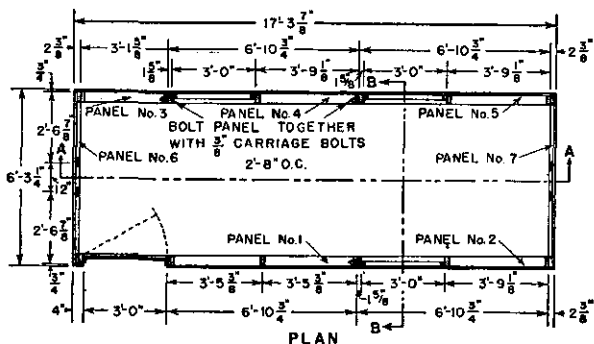

PLAN

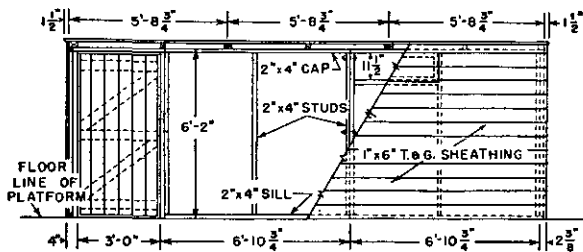

FRONT ELEVATION

① Plan, front elevation, and section

Figure 117. Alternative ammunition shelter for 40-mm anti-aircraft gun tower.

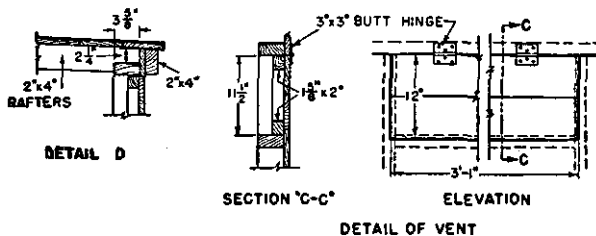
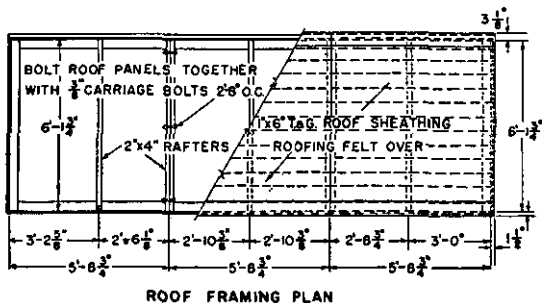
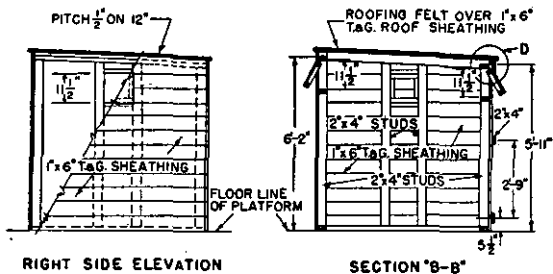

② Side elevation, roof-framing plan, and details

Figure 117—Continued.

TABLE XXX. Bill of material for alternative ammunition shelter
Lumber cutting list

Size	Length	Quantity	Cut from—	Order	Board feet	Description
2" x 4"	17' 3"	3	18' 0"	3	36	Bolting strips.
Do	6' 0"	2	12' 0"	1	8	Door jambs.
Do	5' 10 ³ / ₄ "	6	12' 0"	3	24	Studs, panels Nos. 1 and 2.
Do	To cut	8	12' 0"	4	32	Studs, panels Nos. 6 and 7 to ft.
Do	5' 7 ¹ / ₄ "	8	12' 0"	4	32	Studs, panels Nos. 3, 4, 5.
Do	6' 10 ³ / ₄ "	8	14' 0"	4	38	Caps and sills, panels Nos. 1, 2, 4, 5.
Do	3' 1 ³ / ₈ "	2	8' 0"	1	6	Caps and sills, panel No. 3.
Do	6' 1 ³ / ₄ "	2	14' 0"	1	9	Sills, panels Nos. 6 and 7.
Do	To cut	2	14' 0"	1	9	Caps, panels Nos. 6 and 7.
Do	3' 3 ¹ / ₄ "	1	14' 0"	1	9	{ Door lintel.
Do	3' 0"	3	14' 0"	1	9	{ Rough vent sills.
Do	6' 1 ³ / ₄ "	9	8' 0"	9	48	Rafters, roof panels Nos. 8, 9, 10.
1" x 6"	6' 10 ³ / ₄ "	28	14' 0"	14	98	T & G side sheathing, panels Nos. 1 and 4.
Do	7' 1 ⁷ / ₈ "	28	16' 0"	14	112	T & G side sheathing, panels Nos. 2 and 5.
Do	3' 4 ³ / ₈ "	14	8' 0"	7	28	T & G side sheathing, panel No. 3.
Do	6' 1 ³ / ₄ "	28	14' 0"	14	98	T & G side sheathing, panels Nos. 6 and 7.
Do	5' 9 ¹ / ₈ "	28	12' 0"	14	84	T & G roof sheathing, panels Nos. 8 and 10.
Do	5' 8 ³ / ₈ "	14	12' 0"	7	42	T & G roof sheathing, panels Nos. 8 and 10.
Do	6' 0"	7	6' 0"	7	21	T & G door sheathing, panel No. 9.
Do	3' 0"	3	9' 0"	1	5	Door battens.
Do	To cut	2	10' 0"	1	5	Door braces.
2" x 2"	1' 0"	4	18' 0"	2	12	{ Rough vent sills and headers.
Do	1' 0"	4	18' 0"	2	12	{ Vent, frames, side windows.
Do	0' 7 ¹ / ₂ "	4	18' 0"	2	12	{ Do.
Do	3' 0"	6	18' 0"	2	12	{ Vent, frames, front and rear windows.
Do	0' 7 ¹ / ₂ "	6	18' 0"	2	12	{ Do.
1" x 2"	5' 11"	2	16' 0"	1	3	{ Door stops.
Do	3' 0"	1	16' 0"	1	3	{ Do.

TABLE XXX. *Bill of material for alternative ammunition shelter—Continued*

Hardware list

Item	Size	Quantity
Carriage bolts complete w/nuts and washers.	$\frac{1}{4}$ ϕ x $3\frac{3}{4}$ "	36
Do	$\frac{3}{8}$ " ϕ x $6\frac{1}{2}$ "	24
Roof nails, galvanized	Standard	5 lb.
Nails	20d	5 lb.
Do	16d	10 lb.
Do	8d	10 lb.
Butt hinge	3" x 3"	10
Do	4" x 4"	3
Thumb latch and handle	$5\frac{1}{2}$ "	5 rolls
Roofing felt, 45-pound per roll.	36" roll	5 rolls

INDEX

	Paragraph	Page
Aids to the study of terrain-----	10, 11	7
Antiaircraft tower 40-MM-----	App. IV	236
Approach-----	83	199
Bombs and projectiles, effects of-----	App. II	224
Breastworks and parapets-----	26	44
Camouflage-----	21	34
Cave shelters, types-----	78	183
Chambers-----	89	218
Classification-----	2, 67, 79	1, 126, 196
Considerations and requirements :		
Tactical-----	68	128
Technical-----	69	131
Considerations, limiting-----	13	23
Construction :		
Materials standard-----	72	147
Types of-----	74, 76	157, 165
Corridors-----	9	6
Cover, overhead-----	71	142
Critical terrain features-----	16	24
Definitions :		
Glossary-----	App. I	221
Terrain-----	4	3
Terrain evaluation-----	4	3
Direction, changing horizontally-----	88	215
Disposal of spoil-----	23	36
Drainage-----	24	37
Emplacements :		
Antiaircraft-----	53	89
Antiaircraft Artillery :		
Fire unit-----	62	115
Gun battery-----	61	104
Machine guns-----	64	121
Miscellaneous-----	65	121
Requirements-----	59	102
Searchlight section-----	63	119
Shelters-----	60	103

Emplacements—Continued.

	Paragraph	Page
Antitank gun :		
37-MM-----	44	75
57-MM-----	45	76
Field Artillery-----	49-57	86
Gun :		
4.5-inch-----	54	89
155-MM-----	55	96
Howitzer :		
105-MM-----	46, 54	81, 89
155-MM-----	54	89
Machine-gun emplacement, concrete-----	App. III	229
Mortar :		
60-MM-----	41	66
81-MM-----	42	69
Employment-----	28	47
Entrances-----	82	197
Entrenchments and emplacements-----	28-65	47
Excavation-----	22, 81	35, 196
Factors, terrain-----	6	4
Features of military importance-----	11	7
Fire, clearing fields-----	20	28
Foxholes-----	31-33	48, 49, 52
Gallery, driving-----	86	206
Gasproofing-----	70	135
Glossary-----	App. I	221
Grades-----	90	218
Guns, machine, caliber .30-----	39, 40	58, 62
Incline, driving with cases-----	84	199
Infantry entrenchments for hasty fortifications-----	30-36	48
Infantry weapon emplacements-----	37-46	58
Influence of terrain-----	5	3
Lay-out-----	91	219
Line-----	90	218
Machine-gun emplacement, concrete-----	App. III	299
Maps and reconnaissance-----	8	6
Materials :		
Construction-----	72	147
Fortification-----	19	28

	Paragraph	Page
Military aspects of terrain.....	15	24
Objectives.....	7	6
Observation posts.....	36	55
Plans.....	91	219
Priority of construction.....	50	87
Projectiles, effects of bombs.....	App. II	224
Protection:		
Against tanks.....	27	45
Personnel.....	51	87
Purpose.....	3, 12	3, 23
Requirements.....	29, 80	47, 196
Revetments.....	25	39
Rifle, automatic.....	38	58
Rocket launcher.....	43	69
Scope.....	66	126
Shaft, sinking.....	85	203
Shelter:		
Ammunition.....	52	88
Cave.....	77-92	181
Cut-and-cover.....	75-76	165
General.....	66-72	126
Individual prone.....	34	53
Surface.....	73-74	156
Slope, change.....	87	214
Tactical study of terrain.....	12-17	23
Technique, general fortification.....	18-27	26
Terrain evaluation.....	3-17	3
Tools.....	18	26
Topography, general.....	14	23
Tower, antiaircraft 40-MM.....	App. IV	236
Trenches:		
Connecting.....	35	53
Special.....	47	81
Standard.....	48	82
Weapon emplacement, infantry.....	37-46	58
Weapons platform.....	57	101
Work, rate of.....	92	219