

FM 10-5

EED, JR.

C

MHI
Copy 3

WAR DEPARTMENT

QUARTERMASTER FIELD MANUAL

**QUARTERMASTER
OPERATIONS**

April 29, 1943

FM 10-5

QUARTERMASTER
FIELD MANUAL



QUARTERMASTER OPERATIONS



UNITED STATES
GOVERNMENT PRINTING OFFICE
WASHINGTON : 1943

For sale by the Superintendent of Documents, U. S. Government Printing Office
Washington, D. C.

WAR DEPARTMENT,
WASHINGTON, April 29, 1943.

FM 10-5, Quartermaster Field Manual, Quartermaster Operations, is published for the information and guidance of all concerned.

[A. G. 062.11 (3-10-43).]

BY ORDER OF THE SECRETARY OF WAR:

G. C. MARSHALL,
Chief of Staff.

OFFICIAL:

J. A. ULIO,
Major General,
The Adjutant General.

DISTRIBUTION: Bn and H (2); R and L 10 (5).

(For explanation of symbols see FM 21-6.)

TABLE OF CONTENTS

	Paragraphs	Page
CHAPTER 1. General.		
SECTION I. Mission and functions.....	1-2	1
II. Relation of Quartermaster Corps to other agencies.....	3-5	2
CHAPTER 2. Organization and training.		
SECTION I. Organization.....	6-7	7
II. Training.....	8-14	10
CHAPTER 3. Supply.		
SECTION I. General.....	15-16	13
II. Procurement.....	17-30	16
III. Storage, distribution, and issue.....	31-33	24
IV. Warehousing.....	34-40	43
V. Subsistence.....	41-48	46
VI. Salvage.....	49-51	52
VII. Remount Service.....	52-55	57
CHAPTER 4. Transportation.		
SECTION I. Motor.....	56-62	61
II. Animal.....	63-67	65
CHAPTER 5. Quartermaster service in divisions and higher units.		
SECTION I. General.....	68-70	70
II. Infantry division.....	71-73	72
III. Cavalry division (horse).....	74-75	87
IV. Armored division.....	76-79	91
V. Mountain division.....	80-81	95
VI. Motorized division.....	82-83	98
VII. The corps.....	84-89	99
VIII. The army.....	90-94	101
IX. The air force.....	95-97	108
X. Theater headquarters.....	98-101	110

QUARTERMASTER FIELD MANUAL

QUARTERMASTER OPERATIONS

(This manual supersedes FM 10-5, March 10, 1941, including C1, July 16, 1941.)

CHAPTER 1

GENERAL

	Paragraphs
SECTION I. Mission and functions.....	1-2
II. Relation of Quartermaster Corps to other agencies..	3-5

SECTION I

MISSION AND FUNCTIONS

■ 1. MISSION.—The mission of the Quartermaster Corps is to assure the successful operation of the Army of the United States by efficiently and economically providing food, clothing, equipment, motor and animal-drawn transportation, and similar services assigned to the Corps by law or regulation.

■ 2. FUNCTIONS.—*a.* Under authority of Title I, First War Powers Act, 1941 (Public Law 354), the Quartermaster Corps, by executive order, is now organized as a Supply Service of the War Department, Army Service Forces. It consists of The Quartermaster General, two Deputy Quartermaster Generals, an Administrative and Advisory Staff, and various operating divisions. The Quartermaster General is the responsible head of the Quartermaster Corps under authority of the Commanding General, Army Service Forces. In the zone of the interior he is charged with—

(1) Purchase and procurement for the Army of all supplies of standard manufacture and of all supplies common to two or more arms or services, but not with the purchase or procurement of special or technical articles to be used or issued exclusively by other supply arms or services.

(2) Storage and issue of supplies.

(3) Motor and animal-drawn transportation of the Army, including troops and supplies.

b. The Quartermaster General is not charged with responsibility for—

(1) Rail, water, or air transportation.

(2) The research, design, development, procurement, storage and distribution of motor vehicles, including accessories and equipment.

(3) Motor maintenance other than second echelon maintenance of vehicles assigned to Quartermaster units and installations.

(4) Exceptions prescribed under special wartime procedure announced by competent authority.

c. Revised Statutes 1141 assigns the Quartermaster Corps the specific duty of purchasing and issuing to the Army the supplies which compose the ration.

d. AR 30-5 specifies that The Quartermaster General has charge of certain national cemeteries, national monuments, and national parks, and the records pertaining thereto.

e. Necessarily, all of the above functions were originally stated in general terms, and most of them subsequently have been the subject of numerous interpretations or exceptions. Their current status and the details of administration and procedure involved must be sought in current War Department directives such as Army Regulations, Field and Technical Manuals, War Department circulars, and Mobilization Regulations. In addition, current directives, such as circulars, orders, letters and other communications are issued by the Commanding General, Army Service Forces.

SECTION II

RELATION OF QUARTERMASTER CORPS TO OTHER AGENCIES

■ 3. GENERAL.—The general functions of clothing, equipping, feeding, and transporting the Army by motor and animal-drawn means bring the Quartermaster Corps, through the Commanding General, Army Service Forces, into close relationship with practically every agency in the Army, including the arms, services, the Office of the Under Secretary of War, the War Department General Staff, and the Special Staff.

■ 4. ARMS AND SERVICES.—Quartermaster supplies cover a wide range of commodities, and include everything required by the Army except certain special supplies which are assigned to other services for procurement, storage, and issue.

Quartermaster supplies include subsistence, forage, fuel, clothing, equipage, animals, animal-drawn vehicles, harness and saddlery, hardware, machine and hand tools, machinery, stationery and office supplies, electrical supplies and equipment other than those used in construction and utilities, and such other supplies of a miscellaneous nature as may be required by the Army. The Commanding General, Army Service Forces, communicates to the Quartermaster Corps the requirements of the several arms and services. When determining the types of supplies needed and how they should be classified and standardized, coordination is accomplished through the activities of the various technical committees of the Quartermaster Corps which have member representatives from all interested arms and services.

■ 5. GENERAL AND SPECIAL STAFFS.—*a. In zone of the interior.*—(1) The War Department General Staff, under the direction of the Chief of Staff, is charged with coordination of the development of the armed forces of the United States to insure the formation and maintenance of a well-balanced and efficient military team. It is specifically charged with the duty of providing such broad, basic plans as will enable the Commanding General, Army Service Forces, to execute his mission of providing services and supplies to meet the military requirements of the Army (with the exception of those peculiar to the Army Air Forces). Through cooperation, coordination, and consultation with technical committees and the arms and services, the Commanding General, Army Service Forces, determines the requirements for supplies and services procured, stored, and issued by the Quartermaster Corps, and where and when they will be needed. The Quartermaster Corps, under the supervision of the Commanding General, Army Service Forces, determines how and where they will be procured, stored, and issued.

(2) Briefly stated, as far as the Quartermaster Corps is concerned, the Commanding General, Army Service Forces determines the requirements of supplies and services. The requirements that pertain to the Quartermaster Corps are then computed by The Quartermaster General, who procures, stores, and issues them.

b. In theater of operations.—(1) One of the principal responsibilities of the commander of a theater of operations is the organization and administration of a system of supply for the maintenance of all the forces of his command. Control over the system of supply is centralized at headquarters, theater of operations, but supply operations are conducted under the supervision of subordinate commanders. The commander of the theater formulates the general plan for organization and administration of the system of supply and promulgates it in the form of general or specific directives to the operating agencies. When formulating his general plans, the commander of the theater of operations is assisted by his general and special staffs, which include his chiefs of supply services.

(a) The quartermaster, theater of operations, is the principal officer of the Quartermaster Corps on the staff of the commander of the theater of operations. He is responsible to the commander for the efficiency of the entire quartermaster system of supply and transportation. He carries out this responsibility by keeping the commander of the theater (and the general and special staffs) informed at all times of the capabilities of the Quartermaster Corps in the theater, and by preparing plans and programs for Quartermaster Corps operations which when approved by the commander of the theater and embodied in orders or instructions through the usual channels of command, become directives to subordinate commanders. He exercises constant supervision of all quartermaster activities in the theater through inspections, and systems of routine and special reports; and he maintains close liaison with the quartermasters of subordinate commands such as the quartermaster of the communications zone, army quartermasters, and the quartermaster supply officers at regulating stations.

(b) The parts of the general plan for which the quartermaster, theater of operations, will be required to submit recommendations or plans are those which relate principally to the following:

1. Procurement, storage, and distribution of quartermaster supplies, including animals and animal-drawn transportation.

2. Establishment and operation of the graves registration service.
3. Establishment and operation of the salvage service.
4. Transportation of troops and supplies except those allocated to another service for transportation.
5. Regulations for operation and inspection of motor and animal transportation.

(2) *Special staffs.*—(a) In divisions and higher units, a quartermaster staff officer is a member of the commander's special staff. This staff includes the heads of the technical, supply, and administrative services and certain technical specialists. As a special staff officer, the quartermaster supervises the quartermaster activities throughout the command, and in most instances also commands his quartermaster unit and attachments. These two functions of staff and command, although vested in a single individual, have separate and different responsibilities and duties, and the exercise of one should not be confused with or be permitted to interfere with the exercise of the other. This dual function has many advantages in facilitating the proper discharge of both staff and command duties. His prescribed duties and responsibilities are:

1. Adviser to the commander and staff on quartermaster matters.
2. Determination of requirements; procurement, storage, and distribution of quartermaster equipment and supplies.
3. Operation of remount service; general service pool of labor; salvage service; graves registration service; quartermaster motor transportation, including first and second echelon motor maintenance.
4. Technical inspection of motor and animal transportation in subordinate units within limits prescribed by the commander.
5. Examination of captured quartermaster equipment.

(b) The quartermaster is given a mission in the form of approved plans and administrative orders. Within the scope of these plans and orders and within the limits of the resources at his disposal, he has complete freedom of action in

order to insure the best possible performance of his mission. Matters concerning routine and technical details are usually handled by personal conference or correspondence with the quartermaster staff officers of the next higher or lower echelons. All other instructions must be issued through the proper command channels. Each unit quartermaster is responsible for seeing that his superiors are fully informed, through proper channels, of the situation of his unit.

(c) Cooperation within the special staff is necessary to insure proper staff teamwork; and staff teamwork is necessary to successful execution of the commander's plans, including the quartermaster plan. The use of tact and the maintenance of cordial relations between special staff officers promote cooperation.

(d) A quartermaster's relations with quartermasters and supply officers of subordinate units are those of a special staff officer of the higher unit commander. He does not exercise his command function in such dealings.

c. Peacetime relationship.—In peacetime, the Quartermaster Corps relation to other agencies is similar to that in the zone of the interior in wartime. Much of the work is the same in peace as in war. Differences or variations between peacetime and wartime operating policies are indicated throughout this manual.

CHAPTER 2

ORGANIZATION AND TRAINING

	Paragraphs
SECTION I. Organization.....	6-7
II. Training.....	8-14

SECTION I

ORGANIZATION

■ 6. GENERAL.—*a.* The Quartermaster Corps is a supply service of the War Department Army Service Forces. The Quartermaster General directs the activities of the Quartermaster Corps. He is directly responsible to the Commanding General, Army Service Forces, for the efficient performance of the functions assigned to the Corps and reports to him on all matters affecting it.

b. There are two Deputy Quartermaster Generals. One directs supply planning and operations, the other directs administration and management. They act for and in the name of The Quartermaster General, and supervise and coordinate the functions related to administration, management, planning and supply operations in the Quartermaster Corps.

c. The operating divisions of the Quartermaster Corps are organized to carry out effectively the mission, duties, and functions assigned to the Corps. The officer in charge of each operating division is known as the Director of the Division.

d. The operations of the Quartermaster Corps require a logical functional organization of three main divisions: administration, supply, and transportation. These main divisions are broken down into the organization described above, and are indicated in figure 1. Every function and activity of the Corps is administered in the office of The Quartermaster General. Field offices and installations conform, in general, to the organization of the office of The Quartermaster General.

■ 7. QUARTERMASTER UNITS.—*a.* Quartermaster troops and personnel are classified according to the function for which they are primarily designed. According to assignment or attachment, quartermaster units are either divisional or nondivisional. The following are the organic divisional quartermaster units:

- (1) Quartermaster companies of infantry divisions.
- (2) Quartermaster squadrons of cavalry divisions.
- (3) Supply battalions of armored divisions.
- (4) Quartermaster battalions of motorized divisions.
- (5) Quartermaster battalions of mountain divisions.
- (6) Quartermaster companies of airborne divisions.
- (7) Quartermaster battalions of engineer amphibian brigades.

b. All other quartermaster troops are nondivisional and may be classified in the following groups:

(1) *General service.*—These include companies and battalions designed to provide a general labor pool and to furnish the unskilled labor required for all quartermaster service operations.

(2) *Supply.*—These include railhead companies, depot companies, sales companies, bakery companies, and refrigeration companies; supply base (aviation) platoons, service group (aviation) companies; depot companies, class III (aviation); and depot companies, subsistence (aviation).

(3) *Motor transport.*—The units in this group may be classified as follows:

(*a*) *Operating.*—These include companies and platoons, aviation; companies, battalions, and regiments, truck; and companies, car.

(*b*) *Supply.*—These include gasoline supply companies and battalions.

(4) *Animal transport.*—These include wagon companies, pack troops, remount troops, and squadrons.

(5) *Miscellaneous.*—In this group are placed the so-called utility units, such as sterilization companies, salvage collecting companies, salvage repair companies, laundry companies, laundry platoons, hospital, graves registration companies, and headquarters, quartermaster salvage depots.

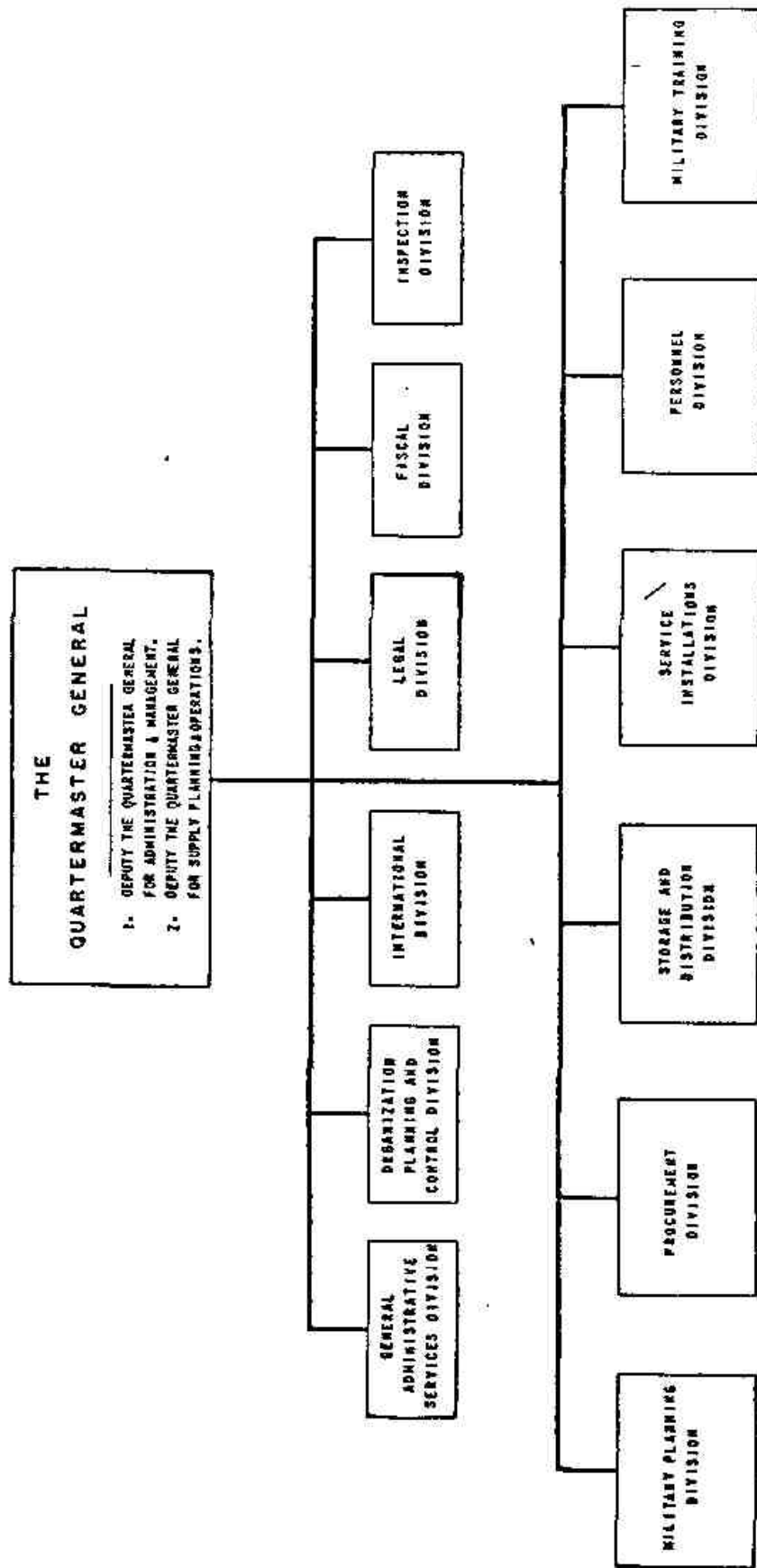

FIGURE 1.—Organization chart, office of The Quartermaster General.

(6) *Detachments.*—In addition to the above units, there are quartermaster detachments of various compositions at posts, camps, and stations throughout the Army which carry on the routine duties of supply, motor and animal transportation, and other activities assigned to the Quartermaster Corps. These detachments utilize a large portion of the personnel of the Corps.

c. Although the work of most of the quartermaster units is of a technical nature, they are nevertheless military units subject to similar field conditions as other units of the military force. They are organized along military lines for discipline, for military administration, and for their own defense.

d. The technical organization is along functional lines. The units are divided into appropriate subdivisions, each subdivision being charged with the supervision and operation of some technical activity.

SECTION II

TRAINING

■ 8. **MISSION.**—The training mission of the Quartermaster Corps is to train its personnel and units to carry out their assigned duties in such a manner as to increase the combat efficiency of the Army as a whole.

■ 9. **ESSENTIAL SUBJECTS.**—In the training of troops it will be found that the essential subjects may be classified under four groups: basic, technical, tactical, and administrative.

■ 10. **BASIC TRAINING.**—*a.* Troops of the Quartermaster Corps must be proficient in the following:

(1) The basic training of a soldier as outlined in mobilization training programs.

(2) Administration.

(3) Protective measures against chemical agents, aircraft, and mechanized attack.

(4) Care and use of applicable weapons, equipment, and transportation.

(5) Technical service of quartermaster technical units.

(6) Tactics and technique of the Quartermaster Corps.

(7) Cooperative duties as part of the tactical team.

b. The basic training includes the general military qualifications required of all troops plus some specialties particularly applicable to the Quartermaster Corps. Each unit must have sufficient military training to provide for its administration, protection, subsistence, clothing, transportation, and discipline.

■ 11. TECHNICAL TRAINING.—This group includes technical qualifications necessary for the operation of quartermaster specialties. These are special subjects in the following categories: military, administrative, supply, and motor and animal transportation. To carry on the technical operations, various specialists must be trained in the units to which they are assigned, in schools or in replacement and training centers. Personnel with experience in related civilian occupations are more readily trained, and should be obtained when possible.

■ 12. TACTICAL AND ADMINISTRATIVE TRAINING.—This group includes qualifications in road discipline and field exercises, embracing loading and distribution of supplies, troop movements and convoy operations, communication, concealment, protection, and encampments and general field duties as part of a tactical organization. All quartermaster commanders of units in a tactical organization must be familiar with tactics. Sound judgment should be developed by applying fundamental tactical considerations in the solution of field exercises, beginning with simple situations that might confront platoon and company commanders. Such situations can be incidents in the problems of battalion or higher commanders, thus enabling each commander to become better acquainted with the part he is to play in tactical operations. The fact that quartermaster organizations have certain routine duties must not be permitted to interfere with the carrying out of a definite training program. A certain part of every working day must be set aside for training.

■ 13. PROGRESSIVE TRAINING.—a. All training should progress from the elementary to the more advanced. Individuals and small units should be trained first. Subsequent training will

proceed to larger and larger subdivisions until the training of the unit as a whole is accomplished. A progressive program gives opportunity for training subordinate leaders in the responsible exercise of command. Concurrent training of higher and lower units gives to all an appreciation of the part each subdivision must play in the unit team. Refresher training must be carried out to the extent necessary to maintain standards once they are attained.

b. During mobilization, it is necessary to change the emphasis from progressive training to balanced training to insure the ability to break off training before the mobilization training period is completed and move to the theater of operations, and to operate as a unit or part of a larger force.

■ 14. **APPLICATORY SYSTEM.**—The applicatory system of training should be employed wherever possible. It requires the individual or unit under instruction to apply methods (being taught) to an assumed or outlined situation simulating war conditions. It involves the following steps, which should be understood and applied to all training: preparation of subject matter and assembling of equipment, training aids, etc., by the instructor; explanation, demonstration, or illustration; application, or practice to acquire skill in execution; examination or test to determine state of proficiency; and discussion or critique and “follow up” exercises to point out correct and incorrect methods of execution.

CHAPTER 3

SUPPLY

	Paragraphs
SECTION I. General	15-16
II. Procurement	17-30
III. Storage, distribution, and issue	31-33
IV. Warehousing	34-40
V. Subsistence	41-48
VI. Salvage	49-51
VII. Remount Service	52-55

SECTION I

GENERAL

■ 15. **FUNDAMENTAL PROCEDURES.**—Fundamental procedures of supply are carefully calculated rules of action designed to carry out, in the most expeditious and efficient manner, the functions which are a part of the supply mission of the Quartermaster Corps. Certain of these rules as outlined below apply to any type of supply mission.

a. Troops should not be burdened with a greater quantity of supplies than is necessary to insure their well-being, their proper training, or their readiness for action.

b. Supply details should not divert the attention of combat troops from their training for or engagement in their fundamental mission, which is to defeat the enemy.

c. Supply systems should have continuity, flexibility, elasticity, mobility, and simplicity.

d. The impetus of supply should be from the rear toward the point of consumption.

■ 16. **APPLICATION.**—*a. General.*—(1) The fundamentals of supply are applicable under all conditions of operation, but the degree of application for any one rule will vary according to the needs of the particular situation.

(2) The greatest limit of variation under which these fundamentals are applied is that between the operating conditions of peace and war. Other variations are found between the zone of the interior and the theater of operations, and between the communications zone and the combat zone.

(3) In the interest of administrative and operating efficiency, supply is divided into various functions, such as procurement, storage, issue, salvage, accounting, and distribution. All of these functions contribute to the application of the fundamentals of supply, and taken together they comprise the machinery with which the supply mission is carried out.

(4) The rules listed in paragraph 15 are applied by means of planned arrangements of administration and operation and by physical mechanisms such as depots, dumps, and other supply installations. There is no clear-cut dividing line between the results obtained by the application of one fundamental, and the application of one rule will often bring another into operation. The entire supply mission is thus carried out by an interweaving and overlapping of applied fundamentals.

b. Continuity.—Continuity of supply is achieved by organization; first, to secure the supplies promptly, and second, to maintain their flow from point of origin to point of consumption. To aid in maintaining this flow during periods of irregularity or interruption, reserves are created in various places, amounts, and types.

c. Flexibility.—A supply system must have the quality of flexibility in order to conform to the requirements of the tactical or strategical situation, thus leaving the commander full freedom of maneuver and physical flexibility in his supply system. The rule of flexibility is applied by injecting into the supply system such arrangements as will permit it to adjust itself, without disruption, to unusual demands, changing situations, and sudden diversions of the flow into new and unusual channels. Practically, this quality is attained by decentralization of operation, efficient administrative control, and careful selection of locations for installations.

d. Elasticity.—This quality in a supply system requires characteristics which will permit it to expand, contract, or be distorted, and return to normal after such distortion without break-down or fatal loss of efficiency. Since there is no real "normal" in war, it is considered a normal situation when the campaign progresses according to plan, the

supply system being based on that plan. The rule of elasticity is introduced into the supply system in operation when it is planned to meet not only "normal" situations, but also the probable expansion and contraction which may develop. This rule is applied by planning for the expansion and contraction of stock levels, for the expansion and contraction of the facilities for handling supplies, and for the manipulation of the supplies to conform to whatever tactical plan is put into operation.

e. Mobility.—Stored supplies are only a potential asset. Until they are given movement, they are not a real asset to the consumer. The simplest form of mobility is that in which the individual carries on his person a supply sufficient for his own needs for several days. The more the individual soldier is burdened with supplies the less mobile he becomes. The same is true of a supply system as a whole; that is, the more the unit is burdened with supply, the lower is its tactical mobility. Hence, a compromise must be made in order to attain both reasonable certainty of supply and necessary tactical mobility. This is done by carrying certain supplies, called "prescribed loads", in unit transportation. The designated limits in the size of the loads are the limits of compromise between certainty of supply and the optimum of mobility. In places other than the combat zone, mobility is achieved by proper echelonment, territorial distribution, regulation of size of storage places, location of stocks on or near good rail and road connections, and maintaining sufficient transport and labor to assure that supplies can be moved where and when needed.

f. Impetus.—Supply is a function of command, and it is the duty of every commander to assure adequate supply for his command. The statement that the impetus of supply is from the rear implies that it is the duty of each higher commander to furnish supplies at a point within reach of his subordinate commanders. In many cases, trains of subordinate units must go to the rear a certain distance to pick up their own supplies. The impetus, therefore, should come from the rear only so far as subordinate commanders cannot assist themselves. It is still the duty of these subordinate commanders to assure supply for their units by all means

at their disposal. To do this, every subordinate commander has the definite responsibility of keeping his next higher commander informed of his supply needs in sufficient time to permit furnishing these supplies by normal methods. The term, "within reach", is relative, and the definite distance involved in any particular case depends upon the type and amount of transportation available, the location and condition of the road and rail net, and other similar factors. When a division commander designates a distributing point a comparatively short distance behind the front line, he adheres to this rule just as fully as he does when he requires the artillery ammunition trains to go to designated ammunition supply points which may be many miles to the rear.

SECTION II

PROCUREMENT

■ 17. **RESPONSIBILITY.**—The Quartermaster General is charged by statute with the procurement of all supplies of standard manufacture and all supplies common to two or more arms and services, with certain exceptions. He carries out this statutory responsibility through the procuring agencies outlined in paragraph 18.

■ 18. **PROCURING AGENCIES.**—*a. Manufacturing facilities.*—(1) The Jeffersonville Quartermaster Depot produces tentage, leather, metal, and wood products, and canvas articles and equipment.

(2) The Philadelphia Quartermaster Depot manufactures textile products such as various types of flags, breeches, trousers, and shirts.

(3) All orders for the articles manufactured in these factories are placed through The Quartermaster General.

b. Procuring depots.—A large portion of quartermaster items is procured by contract from commercial sources. This type of procurement is effected by quartermaster depots. In locating these depots, consideration is given to both procurement and distribution functions.

c. Post, camp, and station quartermasters.—For certain articles, local purchase by post, camp, and station quartermasters is authorized. (See par. 22c.)

d. Interdepartmental procurement.—Other governmental agencies are important in the procurement of supplies for the War Department. The principal agencies in this category are the Procurement Division of the Treasury Department, the Navy Department, the Post Office Department, the Federal Prison Industries, Inc., and the Government Printing Office. Advantages of procurement through these governmental agencies include assured quality of product through standardization of items, reduction in administrative procedure, and reduced costs through quantity purchase.

■ 19. CLASSIFICATION OF SUPPLIES.—*a.* The term “supplies” includes both materials and nonpersonal services. Material supplies are classed as general or special. The Quartermaster Corps, principally, procures the general supplies common to two or more arms and services.

b. To facilitate procurement, all supplies are divided into commodity groups as shown in section III of the Federal Standard Stock Catalog. These commodity groupings are used in procurement activities and for procurement planning.

■ 20. REQUIREMENTS.—The type and quantity of items required are covered in approved Tables of Basic Allowances, Tables of Equipment, and Tables of Allowances. Great care is exercised in the preparation of these tables by the using arm or service concerned. The Tables of Allowances for posts, camps, and stations are dependent upon appropriations, and are prepared by The Quartermaster General as specifically directed by the Secretary of War.

■ 21. FUNDS.—Funds for the procurement of supplies and services are allotted annually in time of peace by the Congress to the various supply arms and services in accordance with approved needs as set forth in the annual budget estimates. In time of war, they are allotted as needed without regard to the estimates set forth in annual budgets.

■ 22. METHODS.—Under its system of centralized control and decentralized operation, the Quartermaster Corps utilizes four methods of procurement:

a. Centralized.—Those items for which the requirements of the entire Army can be consolidated for long periods of

time and which can be advantageously purchased by one office are purchased and distributed by certain designated depots only.

b. Procurement districts.—To further the decentralization and coordination of procurement activities, each of the fifteen distributing depots is assigned a procurement district which is also its distributing area. Each procurement district is designated by the name of its depot, such as Boston Quartermaster Procurement District, etc. The supervision of procurement functions which may be delegated to the chief of a procurement district either by The Quartermaster General, by another procurement district, or by the Philadelphia Depot is—

(1) Surveying facilities to determine the justification for an award.

(2) To receive and forward bids or to open bids and forward results.

(3) To negotiate contracts.

(4) To investigate delinquent contracts.

(5) To expedite contracts.

(6) To give out information concerning other depot purchases and assist facilities in bidding.

(7) To furnish inspectors and check on them.

(8) Such other functions as can be centralized.

c. Local.—Perishable articles grown locally and not procured by market centers, and articles not carried in stock by distributing depots or assigned to special supply points for purchase and distribution, which are more readily and economically obtained locally, are purchased by post, camp, and station quartermasters.

(1) Funds for the local procurement of supplies and services are allotted by The Quartermaster General to depots for distribution to posts, camps, and stations. Within the continental United States, excluding Alaska, the distribution of quartermaster funds for the local procurement of supplies and services is made by depots to all posts, camps, and stations within their respective areas of distribution, except that commanders of service commands will distribute funds to posts, camps, and stations within their respective service commands when used exclusively for the employment of

civilian personnel, and for the care and maintenance of national cemeteries. Ports of embarkation will receive direct allotments from The Quartermaster General. Funds for the local procurement of gasoline and lubricants will be distributed by the proper depots within their respective distribution areas to posts, camps, and stations, including ports of embarkation. Each distributing depot will submit to The Quartermaster General's Office a quarterly estimate of the funds required for distribution to posts, camps, and stations within its area of distribution.

(2) When requisitions are received at a depot for supplies not carried in stock, and the quantities are small or of such a nature that local purchase is justified, such requisitions are returned through channels with recommendation for local purchase. This procedure will not be followed in relation to the prescribed list of restricted items. If these items are not available in stock, the depot will submit extract requisitions to the office of The Quartermaster General for administrative action.

d. Restricted.—Procurement of certain supplies must be controlled closely due to limited funds, infrequent use, or rigid specifications. Such items are listed in circulars of the office of The Quartermaster General, and all requisitions for these items must be forwarded by the depots after editing to The Quartermaster General. The quartermaster agency best suited to purchase such items is designated as the procuring agency.

■ 23. CONTRACTING OFFICERS.—*a.* Purchases are made only by officers who have been designated as contracting officers by the chief of the supply arm, service, or bureau concerned. This designation may be accomplished by either general or special instructions.

b. In definite quantity purchases, the officer who signs the agreement makes the purchase. In indefinite quantity agreements, the purchase is made by the officer who signs the instrument bearing the statement as to the specific funds chargeable and the sufficiency thereof.

■ 24. ADVERTISING.—*a.* In order to expedite the procurement of supplies, all supply contracts will be placed without formal

advertising. Supply contracts are contracts for supplies, equipment, and nonpersonal services.

b. If, in a particular case, a contracting officer deems it to be in the interest of the United States to secure bids by formal advertising, he will submit a request therefor to the Director of the Procurement Division, Office of The Quartermaster General. Such requests will state in detail the reasons therefor; approval for such procedure must be obtained from the Office of The Quartermaster General.

■ 25. CONTRACTS.—*a.* All transactions which involve the expenditure of funds for the procurement of supplies must be evidenced by a prescribed written record.

b. A contract once entered into cannot be modified except for the benefit of the United States. Standard contract forms provide for changes to be made by the contracting officer in the form of "change orders." Change orders are mailed to the contractor in the form of a letter. If such changes are accepted by the contractor, the contract stands as modified.

■ 26. NEGOTIATED PURCHASES.—*a.* Under authority of the Act of December 18, 1941, all supply contracts will be negotiated or placed without formal advertising. All contracts will be made by one of the following methods:

(1) By soliciting telephonic, telegraphic, letter, or other forms of informal quotations from as many qualified bidders as practicable.

(2) By soliciting quotations on Quartermaster Corps Form of Request for Informal Bids. This method will be used by purchasing depots only.

(3) By direct negotiation.

b. Supply contracts are negotiated to expedite the procurement of supplies and to eliminate delays occasioned by formal bidding. This method assures that contracts will be awarded to those contractors having financial responsibility, competent management, necessary machinery, and satisfactory records of performance.

c. Awards of contracts or changes therein amounting to less than \$5,000,000 (or when the estimated amount in the case of cost-plus-a-fixed-fee contracts, or changes therein.

is less than \$5,000,000) may be made by the contracting officer without the approval of higher authority. When an award amounts to \$5,000,000 or more, it must be forwarded for approval to the Director of the Procurement Division, Office of The Quartermaster General.

d. All negotiated contracts will contain the statement: "Negotiated under authority of First War Powers Act, 1941, and Executive Order No. 9001, December 27, 1941."

e. While price is always an important consideration, it may be necessary to purchase at other than the lowest prices offered. All prospective contractors will, in advance of award, be informed of the essential terms and conditions of the contract.

f. Awards, however, should not be made in order to keep a firm in production to the exclusion of another firm which tenders a lower price, and which has adequate facilities and unquestioned ability to produce satisfactorily. Contracting officers should use their own good judgment in determining the method which results in the best production and at the same time is fair to all capable producers.

■ 27. LIMITATIONS AND RESTRICTIONS.—a. Procurement officers, as authorized agents of the Government, are limited and restricted by—

- (1) Statutory laws.
- (2) Acts of Congress.
- (3) Executive orders.
- (4) Decisions of the Comptroller General.

b. These laws and regulations are covered generally in Procurement Regulations. Prohibitions relative to certain acts of contracting officers include—

- (1) Entering into contracts without first securing definite appropriations to cover payment for supplies or services.
- (2) Contracts and expenditures in excess of allocations or allotments.
- (3) Advances of public money before services or supplies are obtained; however, advance payments will be made to contractors in cases where such action will facilitate the war effort, provided the United States is adequately protected.
- (4) Acceptance of voluntary services.

c. Other laws and regulations require or authorize—

(1) Compliance with laws relative to wages and hours of employees of contractors (Walsh-Healey Act).

(2) Performance of certain work at Government-owned arsenals.

■ 28. INSPECTION BEFORE ACCEPTANCE.—a. Before supplies are accepted, they must be inspected either at manufacturers' or dealers' plants or at the point of delivery; only articles that conform to specifications, description, or sample will be accepted. The contracting officer or the officer in charge of inspection and delivery (if one is designated) provides the necessary inspecting personnel, and issues such instructions as may be required in cases where inspection at point of origin is required.

b. Post, camp, and station quartermasters are responsible for complete inspection of supplies procured locally. Where facilities for local inspection are lacking, such supplies are inspected by personnel from the proper supply depot.

c. Depots which are designated as central procurement agencies for specific items also provide the necessary inspectors for such items.

d. The facilities of the Bureau of Standards are extensively used in connection with experimental testing, inspection, and development work. This type of inspection must be directly authorized by The Quartermaster General, who allots funds to cover necessary costs.

■ 29. REPORTS.—The following reports on procurement activities are required to be submitted:

a. Chiefs of arms, services, and the National Guard Bureau submit reports and recommendations to the Director of Procurement Headquarters, Army Service Forces, where the procurement of supplies from another supply arm or service, or from Government-owned manufacturing establishments under control of the War Department, has proved uneconomical or undesirable.

b. A report of every original purchase action which exceeds \$10,000.00 (actual or estimated) in amount will be made on a prescribed form and forwarded through The Quartermaster General to the Statistics and Progress Branch, Control Divi-

sion, Headquarters, Army Service Forces, in time to be received by the fifth day of the month following the purchase action.

c. A summary of all purchase actions will be rendered for each calendar month as of the last day thereof on a prescribed form and forwarded through The Quartermaster General to the Statistics and Progress Branch, Control Division, Headquarters, Army Service Forces, in time to be received by the fifth day of the month following. In case no activity is shown for a particular month, a negative report will be submitted.

■ 30. IN THEATER OF OPERATIONS.—*a.* Supplies are obtained in the theater of operations by prearranged schedules of shipments from or by requisitions on the zone of the interior; by exploitation of local resources, including captured material, and by salvage of equipment partly worn out or abandoned. It is fundamental that all supplies and local resources available in the theater of operations should be utilized to the utmost. The utilization of supplies such as food, forage, and fuel is important. Supplies are sometimes furnished without a request as a result of an estimate of existing needs made by a supply service. Initial stocking of a depot may be made in this manner. Supplies such as rations, whose rate of consumption is constant, are forwarded on information furnished by strength reports. Supplies may be furnished as a result of a requisition on a supply agency or a request in writing. They are usually made on a form provided for the purpose. Approval of a requisition by an office higher than the office of origin is usually required. Credits may be established. In this case a designated amount of stated classes is made available to the consumer at a specified place. In an emergency, supplies may be furnished on an informal request, either oral or written. (See FM 100-10.)

b. Each commanding general in charge of a theater of operations outside the continental United States and its territories or possessions, except as limited by any special restrictions contained in his instructions in a particular case, will have full power to do any acts or things within such theater of operations in connection with the procurement of arms, munitions, materials, supplies, quarters, services, works, and

facilities which he may deem necessary or desirable to facilitate the prosecution of the war and to accomplish the mission confided to him, or to protect the health, safety, and welfare of the forces under his command, including the power to do any acts and things relating to the making, amendment, modification, or performance of contracts which he may deem necessary or appropriate.

c. If the commanding general deems it necessary, the power and authority conferred may be exercised notwithstanding any provision of Army Regulations, Procurement Regulations, or other regulations, circulars, or instructions, and notwithstanding any provisions or restrictions of the laws of the United States which may be applicable within the United States or any territory or possession thereof; and may make contracts in any form and containing such provisions as he may deem necessary or appropriate, and may omit from any contract or agreement made and to be performed outside the continental United States and its territories and possessions any provisions customarily used or required within the United States or any territory or possession thereof, which may seem inappropriate, unnecessary, or inexpedient in connection with such contract by reason of local conditions or otherwise.

d. Any such commanding general may delegate, with power of sub-delegation, by order, written instruction, or otherwise, any power, discretion, or authority which he may be empowered to exercise under these instructions. Such delegation may be made in such manner, upon such terms and conditions, and to such military or civilian personnel under his command as he may deem proper. Such commanding general may designate one or more officers as contracting officers and may revoke or modify such designations at will, and may from time to time authorize such contracting officers of the United States whether or not under the command of such commanding general.

SECTION III

STORAGE, DISTRIBUTION, AND ISSUE

■ 31. GENERAL.—Supplies, having been procured as described in section II, must be stored, distributed, and issued to troops

as required. Operation of this phase of the supply service in the zone of the interior and in the theater of operations is described in the paragraphs below.

■ **32. ZONE OF THE INTERIOR.**—*a.* Depots are the backbone of the system of supply. They are the means through which the flexibility of supply operations is assured. Depots of the zone of the interior are classified as depots (other than branch depots) which have been placed under one supply service for administration and in which space is assigned to two or more supply services, and branch depots, being those depots assigned for the exclusive use of one supply service.

(1) Depots jointly occupied by other supply services are operated by The Quartermaster General under the direction and supervision of the Commanding General, Army Service Forces. They are designated quartermaster depots. At these depots, The Quartermaster General is charged with the application of War Department storage policies. These policies are the installation of modern commercial methods of materials-handling; modern warehousing and space conservation; efficient utilization of all common labor; and the preparation of specifications for, and the purchasing of all materials-handling equipment. Funds for necessary overhead will be provided by The Quartermaster General.

(2) At depots jointly occupied by other supply services, The Quartermaster General will allocate all storage and office space. Applications of the various supply services for additional space or for reassignment of space will be made to The Quartermaster General. He will act on these applications in accordance with the policies and instructions of the Commanding General, Army Service Forces. When the quartermaster cannot supply the storage space required by any supply service, he will refer the matter to the Assistant Chief of Staff for Operations, Army Service Forces, who will make the necessary arrangements therefor.

(3) The supply officers of the several supply services will operate, at the depots, directly under their respective chiefs of services on all technical matters pertaining to their service. These matters include assignments, transfers, promotion, and training of military and civilian personnel; and the procurement, storage, and distribution of the supplies

pertaining to the particular supply service. These supply officers will be responsible to the depot commanders on all matters pertaining to general depot administration and discipline.

(4) The commanding officers of the quartermaster depots jointly occupied by the other supply services are designated by The Quartermaster General and are assigned by the Secretary of War. They are responsible for general post administration, including guard, fire protection, general police, and utilities. They are in charge of all transportation facilities, including motor and rail. They are responsible for providing medical facilities at the depot, and for the application of all War Department storage policies.

(5) The Quartermaster General is responsible for the organization and administration of quartermaster branch depots which are assigned for the exclusive use of the Quartermaster Corps. Commanding officers of these depots are Quartermaster Corps officers.

b. Distribution.—(1) *Service commands.*—All War Department supply activities within the territorial limits of service commands are assigned to depots as shown in Circular 1-4, OQMG.

(2) *Oversea department.*—(a) The general plan for the supply of oversea commands is shown in figure 2. Oversea commands are supplied by designated ports of embarkation; class I and III supplies are furnished automatically; class II and IV supplies upon requisition; and class V supplies upon direction of the Commanding General, Army Service Forces and the Commanding General, Army Air Forces. The supply of motor parts is handled as class II supplies.

(b) The War Department determines for each oversea command—

1. Level of supplies to be maintained.
2. Intertheater priorities.
3. A basis of supply for class V supplies (ammunition) when the situation dictates.

(c) The Commanding General, Army Service Forces, performs the following functions:

1. Designation of a port of embarkation responsible for the supply of each oversea command.

2. Determination of reserves to be held in each port of embarkation for other than Army Air Forces technical supplies and designation of credits for each port in zone of the interior depots.
3. Assignment of a representative from each supply service to each port of embarkation for duty in connection with oversea supply.
4. Provision of required water transportation for each port of embarkation.
5. Announcement of policies for handling requisitions by port commanders.
6. Direction of all shipping under Army control other than air.
7. Direction of duplication of shipments of supplies lost at sea.
8. Distribution to an appropriate service of supply activities with troop basis for all oversea bases furnished periodically by the War Department.

(d) The Commanding General, Army Air Forces, furnishes munitions and matériel of exclusive interest to the Army Air Forces; assigns a representative to each port of embarkation for duty in connection with oversea supply; provides required air transportation; and notifies the commander the appropriate port of embarkation of each shipment of air supplies or equipment forwarded to Army Air Forces transit depots for water shipment.

(e) Oversea department, theater, and separate base commanders effect distribution of supplies within their commands; submit requisitions to responsible port commanders for class II and IV supplies (except Army Air Forces technical supplies and Army Air Forces approved T/BA equipment which will be submitted direct to the commanding general, air service command); indicate to responsible commander shipping priorities desired including those for Army Air Forces supplies; report shortages, status of supplies (especially class V supplies); storage space available, and deficiencies in supply procedures; recommend port of entry; develop local resources; recommend levels and locations of strategic reserves.

(f) Port commanders control the flow of supplies through the port and staging areas assigned thereto; maintain required levels of supplies designated as automatic at the oversea command; furnish class II and IV supplies (other than munitions and matériel of specific interest to the Army Air Forces) in sufficient quantity in accordance with requisitions by oversea commanders; submit recommendations to the Commanding General, Army Service Forces, regarding minimum port reserves and zone of the interior depot credits deemed necessary, etc. Port commanders will also submit to the Chief of Transportation requirements for additional storage space and recommendations for required shipping plus maintenance facilities and/or funds necessary.

(g) The Quartermaster General and the other chiefs of supply services designate the depots to serve ports of embarkation and notify the commanders concerned; keep zone of the interior depots stocked to maintain oversea supplies; compute requirements for maintenance supplies to accompany troops overseas and arrange for the timely shipment of these supplies; keep commanders of ports of embarkation informed of any special supplies or equipment set up by the chiefs of supply services as directed by higher headquarters; and furnish automatically to ports of embarkation for shipping to oversea units initial allowances of controlled items of equipment in accordance with established priorities.

(h) Zone of the interior depots supply ports in accordance with instructions received from the Commanding General, Army Service Forces and the Commanding General, Army Air Forces; and report immediately to the chiefs of supply services all request from port commanders which cannot be met. (See W. D. Memo. No. W 700-8-42, Oct. 10, 1942, or subsequent revision thereof.)

c. Classification.—The Federal Government has adopted 74 classes for the storage and issue of supplies. Use of this classification, so far as applicable, is prescribed for the Quartermaster Corps. It is used for all purposes of storage, issue, property record accounting, stock reports, and for the requisitioning of property. All items of standard stock have been or will be listed in the Quartermaster Corps Supplement to the Federal Stock Catalog. Their correct nomenclature is

given. All are classified properly, and information relative to their procurement, storage, and issue is listed. Articles not included in the supplement are classified as nonstandard stock and are to be procured locally as required.

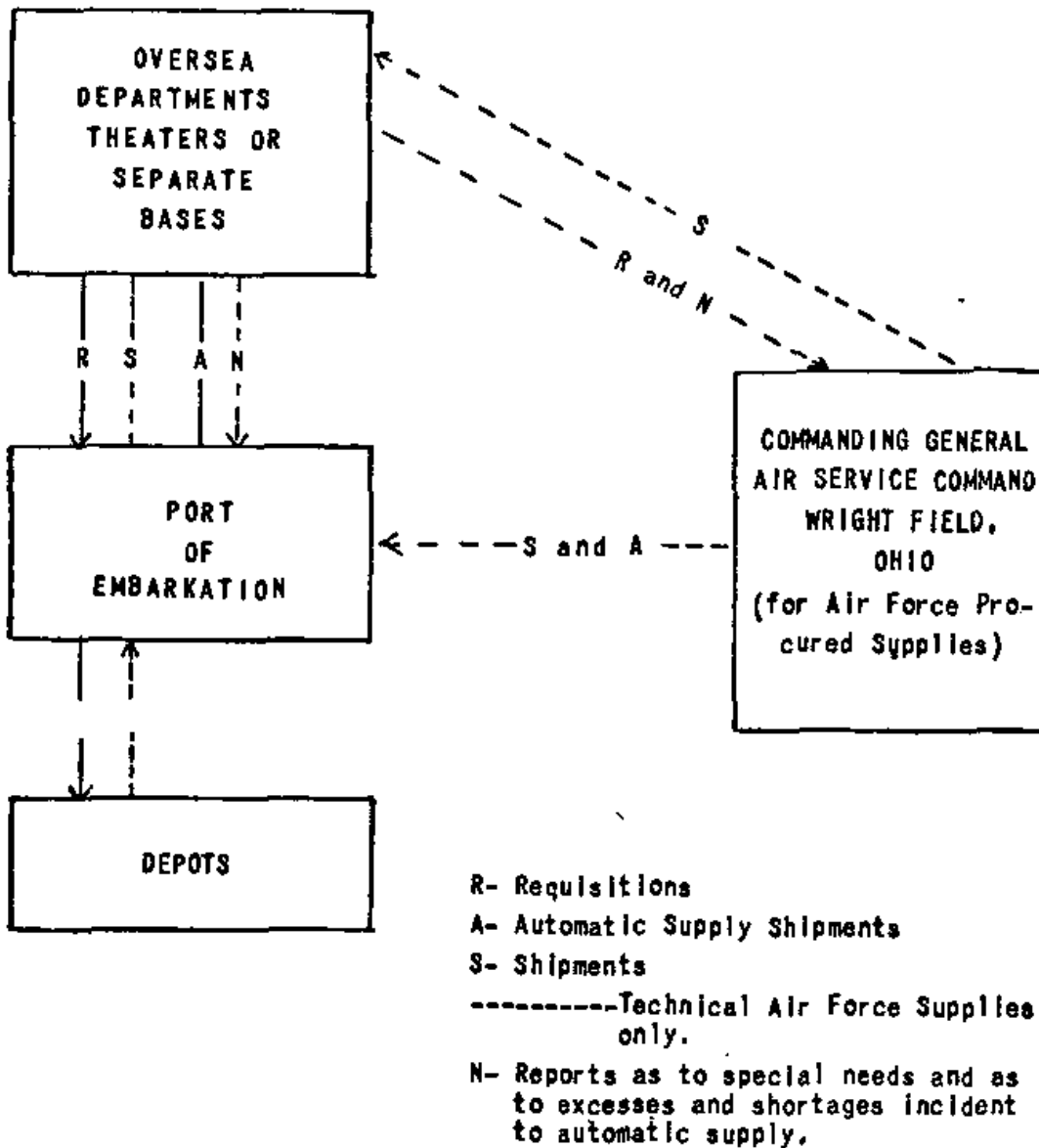

FIGURE 2.—Supply for overseas bases—schematic diagram.

d. Inventories.—Complete, detailed, and accurate inventories of property and supplies on hand in storage must be made by accountable officers at least once each fiscal year. They will also be made at such other times as circumstances may require. Inventories are made for one or more of the following reasons:

- (1) To ascertain exact quantities of supplies on hand.

(2) To permit appropriate adjustment of quantities on hand so as to maintain stocks of supplies in "balanced" or proportionate quantities to meet the needs of the troops.

(3) To inform higher administrative agencies of the status and level of supplies held in storage at supply points under their jurisdiction.

e. Allowances of supplies.—Allowances of quartermaster supplies are prescribed by the War Department. They are published for the Army in Tables of Organization, Tables of Basic Allowances, Tables of Equipment, and Tables of Allowances for Posts, Camps, and Stations. Various Army Regulations cover supply for auxiliaries and for special articles, such as forage.

(1) Tables of Organization prescribe the organic structure of tactical military units, including subdivisions and personnel with qualifications thereof. They show for information purposes only the authorized allowances of weapons, transportation, and principal items of equipment.

(2) Tables of Basic Allowances prescribe the basis for the determination of the authorized allowances of equipment (other than that required for temporary use and for special purposes). These allowances are for the authorized field equipment of individuals and organizations as distinguished from training equipment and that furnished by posts, camps, or stations for use thereat by individuals and organizations. The tables are used for planning purposes by the Commanding Generals, Army Ground Forces, Army Air Forces, and Army Service Forces for activities of their respective commands. In general, distribution will not be made below air force, division, or service command levels. A separate table is published for each arm or service. It includes the allowances for the personnel assigned or attached to the units included in the table.

(3) Equipment authorized by Tables of Allowances is in addition to that authorized in Tables of Equipment. It is not ordinarily taken with a unit into the field or on change of station unless authorized by the War Department. Tables of Allowances prescribe allowances of equipment authorized for—

(a) Posts, camps, and stations.

- (b) General and special service schools.
- (c) United States Military Academy.
- (d) Replacement training centers.
- (e) Disciplinary units.
- (f) Auxiliaries.
- (g) Special activities.

(4) Tables of Equipment prescribe the authorized allowances of equipment for units at their Table of Organization strength (except equipment required for temporary use for special purposes) items of clothing and individual equipment, component parts, spare parts, and expendable items.

(5) Table of Clothing and Individual Equipment prescribes allowances of clothing and individual equipment for individuals of all arms and services, including individuals in installations not organized under Tables of Organization.

f. Maintenance of stocks.—The fundamental principle of stock maintenance is that there shall always be on hand a sufficient quantity of any item which will be required up to the time replenishment of such items can be made. This principle is applicable to stock maintenance at depots, posts, camps, and stations.

(1) The maximum stock requirements of depots are based on issues actually made during a past period which should not exceed 1 year. The troop strength of the distribution area assigned to the depot should be taken into consideration. The quantities established as maximum stock will be revised whenever a considerable change in troop strength occurs. The commanding officers of depots are responsible, within funds allotted, for the maintenance of balanced stocks in sufficient quantities to meet their requirements. They will maintain records of excess stock at posts, camps, and stations within their distribution areas. Control of this stock is vested in the appropriate depot commander. It may be shipped direct to other posts, camps, and stations, or may be returned to depot stock if the depot commander deems it advisable in the interest of orderly stock control and distribution.

(2) The maximum stock of supplies on hand at posts, camps, and stations within the continental United States should not exceed a 60-day level of supply. Level of supply

is defined as "the minimum amount of supplies to be held at a given supply point." It should be held as a reserve to be drawn against only in case of an emergency.

(3) Quartermaster equipment and stocks pertaining to the appropriation "Regular supplies" will not, in the United States, exceed the requirements of a post, camp, or station for a period of 60 days. Requisitions will be submitted monthly in time to reach the designated supply depot 30 days prior to the date delivery is required.

(4) The procurement of supplies (including experimentation, purchasing, and manufacturing) is the responsibility of the chiefs of the individual supply services.

(5) The service commanders, within their respective geographical areas, are responsible for the supervision of supply functions, including the storage, issue, distribution, maintenance, repair, and salvage of supplies and equipment. They supervise and coordinate the activities of posts commanders regarding the storage, distribution, issue, maintenance, repair, and replacement of all items of equipment for newly activated units, units ordered overseas, and other troops stationed within the service command, including Reserve Officers' Training Corps, National Guard, and State Guard units. Supplies to all organizations alerted for movement overseas are furnished by the service commands through the post commanders concerned. They follow up through the post commanders the status of supply of services of supply units located within their service commands.

g. Requisitions.—(1) Supplies are divided for requisition purposes into storage classes. These classes are listed in the Quartermaster Supplement to the Federal Stock Catalog. Supplies are issued to the Army on approved requisitions within the prescribed allowances. Post and station quartermasters secure supplies for issue and replenishment of stock on requisitions submitted directly to the appropriate depot. Separate requisitions are prepared for each supply point. Separate sheets are used for each storage class. Separate requisitions are prepared for items of standard stock and nonstandard stock.

(2) Requisitions for public animals (horses and mules) are routed directly to the Quartermaster General.

(3) Requisitions for "Restricted" items of equipment will be forwarded to The Quartermaster General by depots after edit.

(4) Requisitions for supplies for auxiliaries such as Reserve Officers' Training Corps or Citizens' Military Training Corps are prepared and routed in accordance with the special procedure prescribed for the particular auxiliary.

h. Issue of supplies.—(1) Articles of a nonexpendable nature authorized for issue by the terms of Table of Allowances for posts, camps, or stations are loaned to organizations and individuals upon memorandum receipt signed by the organization commander, individual, or custodial officer, as the case may be. There is a transfer of responsibility, but not of accountability, to the person signing the memorandum receipt. However, when the War Department orders this class of property to be taken by a unit proceeding to theaters of operation, or upon change of station, the accountable officer will consign it on W. D., Q. M. C. Form No. 434 (Shipping Tickets) to the unit commander. This officer will take up such property in his Property Book and thereafter account for it in the manner prescribed for accounting for Tables of Equipment property. Accountability for this property may also be transferred in the case where it is authorized to be taken by an enlisted man on change of station.

(2) Articles of a nonexpendable nature authorized for issue by the terms of Tables of Equipment will be dropped from accountability by post, camp, and station property officers when so issued. Formal accounting will terminate upon issue of this property to organizations or detachments.

(3) Articles of an expendable nature issued to organizations or individuals are dropped from accountability upon issue.

(4) Expendable articles consumed in the maintenance and operation of regular post activities are issued on receipted delivery slips. They are dropped from accountability monthly on the certificate of the quartermaster approved by the commanding officer.

(5) In general, the issue of articles of individual clothing and equipment is similar to Tables of Equipment property. They are dropped from accountability by the post, camp, or

station property officer when so issued. Direct responsibility for the care and preservation of this property is transferred to the enlisted man who receives the property. No record of such property is kept in the Company Property Book. It is listed on the Individual Clothing and Equipment Record (W. D., A. G. O. Form No. 32) of the enlisted man. Articles classed as organizational clothing and equipment are loaned by organization commanders to members of their units, and a record is kept of these loans. Such articles will not be dropped from the Company Property Book because they are organizational property. The commanding officer of any organization is pecuniarily liable for all of the property listed in his Company Property Book. He will in turn hold the individual, who has possession of such property, responsible for its proper care and preservation.

i. Issue of equipment to newly activated units.—(1) Controlled items of equipment will be supplied without requisition in accordance with prescribed priorities.

(2) In connection with equipment other than that which is controlled, timely action must be taken by all concerned to insure prompt initial supply of all authorized articles of individual and organizational supplies and equipment with the minimum of action on the part of the units to be equipped. For all types of divisions, equipment and supplies will be shipped so as to arrive at the proper post, camp, or station not less than 45 days prior to the date of activation for such items as duplicating machine, field safes, commissary chests, tool sets and kits, typewriters, stationery, and blank forms. All other equipment authorized for issue at the date of activation should arrive 30 days prior to the date of activation. For nondivisional units, etc., all equipment and supplies authorized at the date of activation is issued as soon as practicable but not earlier than 30 days or later than 10 days prior to such activation. Requisitions for equipment of newly activated units will not include those items of clothing and individual equipment which are issued to the soldier at the reception centers. Upon receipt of orders directing the activation of units, The Quartermaster General will prepare six copies of the combination equipment charts and requisitions marked to show the specific units to be activated, the date

and place of activation, authority for activation, applicable Tables of Organization and Tables of Allowances and forward all copies to the commanding general of the appropriate service command. These are edited by the service commander and noted with respect to the initial issue of discretionary items after which they are forwarded to the post quartermaster supply officer of the post, camp, or station.

(3) The post quartermaster supply officer will—

(a) Fill in all data indicated under heading "Action by the Post Quartermaster Supply Officer."

(b) Complete column "Supplied by Post Quartermaster Supply Officer" to show the quantity of each item of individual and organizational equipment which will be furnished from post stock.

(c) Complete column "To be Supplied by Depot."

(d) Distribute equipment charts as follows:

1. One copy to unit commander.
2. Four copies to the appropriate quartermaster depot.
3. One copy to be retained for file.

(4) Quartermaster depots will supply from stock as far as possible items listed in column "To be Supplied by Depot."

■ 33. THEATER OF OPERATIONS.—In general, the procedures of storage, distribution, and issue as practiced in the zone of the interior, apply equally to the theater of operations. The mission of each phase of the supply system is to accumulate supplies for the military forces and to issue these supplies as required. The mission in the zone of the interior is continuous during both peace and war, while that in the theater of operations is carried on only during time of war.

a. *Depots* (FM 100-10).—It is the function of the communications zone to provide for the necessary flexibility of supply to the combat zone. Such flexibility can be achieved by the establishment of an adequate echelonment of supply depots from the base, where supplies are received from the zone of the interior, to the combat zone where supplies are consumed by the troops engaged in combat. Depots of the communications zone are organized as "general" depots or arm or service depots in the same manner as in the zone of the interior. Depots in the theater of operations are designated as follows:

(1) *Base depot*.—A general or an arm or service depot, designated as such by the commander of the theater of operations, is located in the base section of the communications zone. These depots are used for the reception and storage of supplies received from the zone of the interior or procured in the base section. Base depots must always be located away from the docks or other heavy traffic centers, or they will soon become so congested that they will be unable to operate. Nothing must be stored in shipping or transit areas. Space must be kept clear for loading and unloading. In these depots, supplies are stored in bulk. Base depots are wholesale establishments and should be organized and function as such.

(2) *Intermediate depots*.—Intermediate depots are used for the reception, storage, and distribution of balanced stocks forwarded from base depots or procured in the intermediate section. They are established only when the depth of the communications zone is such that it is essential to provide an additional echelon in the distribution of supplies. They also provide additional storage space for supplies from the base ports, thus reducing the congestion in base depots. These depots provide the first echelon for classified and balanced stocks, as they must provide storage for supplies in the manner that they are to be consumed. Intermediate depots may be called upon at a moment's notice to function as advance depots.

(3) *Advance depots*.—Advance depots are used for the storage and distribution of supplies of balanced stocks classified as to issue. Supplies stored in advance depots are reduced in quantity below that maintained in base and intermediate depots. This procedure prevents rigidity in the supply system in the vicinity of the combat zone. Stocks are maintained at the prescribed level necessary to meet the requirements for a comparatively short period of time.

b. *Regulating stations* (FM 100-10).—(1) A regulating station is a traffic control agency established on the lines of communication. Through this station, the commander of the theater of operations directs and controls movements to and from the combat zone. Regulating stations are provided, usually, at the rate of one for each army or similar command.

The principal function of the regulating station is to prevent congestion of supply lines into the combat zone by forwarding only the desired supplies and personnel to the front, and by evacuating personnel and material to the rear in accordance with the policy and directives of the commanding general of the theater of operations.

(2) A station quartermaster serves on the station staff of the regulating officer. He performs the usual station quartermaster functions, including that of supply for the regulating station installation.

(3) A quartermaster supply section is organized at each regulating station. This section receives requests from the army, passes them on to the advance depots, transmits tonnage, car, or train requirements to the transportation section, follows up the arrangements made for shipping, and notifies the army when shipments may be expected.

c. Army quartermaster depots.—These are located as far to the front as practicable, but out of hostile artillery range. They are established for the reception and temporary storage of supplies which, because of the situation, must be kept closer to the army than the advance section of the communications zone. The level of supplies of the several classes to be established and maintained in the army service area will be determined by the army commander. His judgment is based on many considerations, such as status of credits; length, vulnerability, and capacity of lines of communication; tactical (strategical) lines of action under consideration; and status of supply within subordinate units. The minimum stockage will consist of sufficient motor fuel and lubricants to resupply all vehicles for one day's maximum activity (class III). Items of essential combat supplies of classes II and IV usually will be stocked in quantities sufficient to replace expenditures for 1 or 2 days of operations. In locating army depots it should be borne in mind, that when an army advances, its depot of today may become an advance depot of the communications zone tomorrow.

d. Storage space in the communications zone.—(1) Storage space in the communications zone is allotted to the services by the commander of the communications zone, who also

determines the location of depots, repair establishments, and other supply establishments pertaining to each service.

(2) The quartermaster of the communications zone keeps adequate records of all storage space, including its disposition and utilization, occupied by establishments of the Quartermaster Corps. He makes application and recommendation from time to time for any additional storage space or depots that may be required in discharging his responsibilities.

(3) Covered storage must be kept down to bare necessity. Approximately 40 percent of the rations and a large proportion of other stores can be stored outside for periods of 2 or 3 months without any appreciable loss. Experience has indicated that about 4 square feet of covered storage per man is necessary for a 45-day reserve. Hay, canned goods, and many other items can be placed in the open if covered with paulins. The amount of open storage space required is generally about three times that of covered storage.

e. Depot lay-out and construction.—The following fundamentals govern the lay-out and construction of quartermaster depots in the communications zone:

(1) The ground space, if at a general depot, should be laid out in the necessary proportions in separate areas for each supply arm or service represented at the depot. Construction should proceed so that the Quartermaster Corps can begin storing supplies, and at the same time, or later, can expand without mixing its supplies with those of other services.

(2) Each storehouse area is laid out in sections, each section having a ladder track on each side connected by house tracks about 1,700 feet long, there being one for each three warehouses. These tracks should be about 150 feet apart, giving space enough for open storage on the side of the track opposite the warehouses, and at the same time providing a fire break.

(3) There should be no dead end in the track system, except where particularly desired for unloading vehicles, so that cars can be moved with the greatest facility.

(4) Provision must be made for unloading incoming cars and loading outgoing cars at the same time with the same commodity. These operations can be performed best if each commodity warehouse is served by two railroad tracks. The

track on one side of the warehouse is to be used for loading, and the track on the opposite side for unloading supplies. If separate tracks cannot be provided, a portion of one track must be designated for loading and another portion for unloading supplies.

(5) Size of storehouses should be such as to require the minimum amount of labor in handling stores, usually 60 feet by 400 to 500 feet, a size generally considered the most economical from the standpoint of both operation and construction.

(6) When time and available labor and material permit (which is seldom the case), the floor of the storehouse should be built on a level with the floor of the average freight car in order to facilitate loading and unloading operations. However, it may be necessary, due to lack of material, to construct many storehouses without floors and to place perishable supplies (such as flour and sugar) on dunnage.

(7) Storehouses (or open storage) from which shipments are made by truck should be on a flank of the depot in order to avoid the congestion and delay caused by crossing railroad tracks. These storehouses should be located, wherever practicable, on existing roads.

(8) No existing roads should be closed by storehouses. It takes more time to construct new roads than to select new sites for storehouses. Moreover, it is often difficult to obtain material for road construction.

(9) Receiving, classification, and departure yards are essential features of all large depots.

(10) Ammunition depots should be separate and distinct from all other depots, and chemical warfare supplies and gasoline should be stored at a safe distance from the remaining lay-out.

(11) The building program must be carried out so that expansion is feasible and that each unit is completed progressively and in succession in such a way that it can be used immediately. For example, it is wrong to start construction on a number of storehouses when only one is needed at once. It is wrong to lay ten railroad tracks in a yard before alining and ballasting any, when perhaps only three tracks are needed immediately. The loss of efficiency caused by using

small units is insignificant compared to the importance of fulfilling the requirements of the military situation.

f. Classification of supplies.—All efforts should be made to simplify supply. Supply service in the theater of operations must become as automatic as possible. This includes the classification of supplies in a manner which will expedite supply and effect convenience in administration; hence supplies for the theater of operations are divided into five classes. (See FM 100-10.)

(1) *Class I.*—Those articles which are consumed at an approximately uniform daily rate irrespective of combat operations or terrain and which do not necessitate special adaptation to meet individual requirements, such as rations and forage.

(2) *Class II.*—Those authorized articles for which allowances are established by Tables of Basic Allowances and Tables of Allowances, such as clothing, arms, gas masks, trunks, radio sets, tools and instruments which are consumed at an approximately uniform rate.

(3) *Class III.*—Engine fuels and lubricants including gasoline for all vehicles and aircraft, Diesel oil, fuel oil, and coal.

(4) *Class IV.*—Those articles of supply which are not covered in Tables of Basic Allowances and the demands for which are directly related to the operations contemplated or in progress (except for articles in class III and V), such as fortification materials, construction materials, and machinery.

(5) *Class V.*—Ammunition, pyrotechnics, antitank mines, and chemicals.

g. Issue of supplies.—Combat troops should be constantly supplied with their current needs but should not be burdened with excess supplies. To assure an efficient state of supply, the following methods of issue are prescribed:

(1) Class I and class III supplies are usually provided on an automatic daily basis. Calls for class I and class III supplies are made by means of the daily telegram. (See par. 73.)

(2) Class II supplies are usually made available in the form of credits in designated depots. When credits are established for an army in communications zone depots, the army supply service concerned makes the necessary calls

direct on the proper communications zone depot or through the corresponding supply officer at the regulating station. If calls are made direct to the communications zone depot, a copy is sent to the regulating officer. Shipments are made up at the depots and dispatched through the regulating station to the proper army supply establishment. The army may send motor transportation to the depot to draw the supplies whenever the situation warrants such action. The army may further reallocate to the division and corps troops such credits of these classes as may have been set up for the army. When credits are so established, division and corps troops may make the required calls direct to the proper communications zone depot through the division or corps quartermaster service. In addition, the army may establish credits for the division and corps troops in army depots. Calls may be made by division and corps quartermaster services in the same manner as outlined above for communications zone credits. In either instance, division and corps transportation may be sent direct to the depot for the desired supplies, in which case they do not pass through the regulating station. If credits have not been established, supply is on a requisition basis. Under these circumstances, supply officers for division and corps troops submit requisitions approved by their unit commanders direct to the army quartermaster, where the requisitions are filled either from available stocks in army quartermaster depots or extracted to the communications zone depots.

(3) Class IV supplies are furnished on requisitions. Articles of supplies of class II may, by reason of special stringency, be transferred to class IV pending the reestablishment of normal status of supply in these articles. Requisitions for class IV supplies must bear the approval of the commander of the theater of operations.

(4) Class V supplies are normally made available in the form of credits at designated supply points for a stated period or operation. The quartermaster is concerned with class V supplies only because the quartermaster service may frequently be called upon to furnish transportation for ammunition.

h. Replenishment of stocks from the zone of the interior.—

(1) Supplies for a theater of operations are obtained from three sources:

(a) Exploitation of resources of the theater.

(b) Captured material.

(c) Replenishment of stocks from the zone of the interior.

An initial supply for each theater of operations must be worked out in advance and shown in the original plan or its appendices. The maintenance of stock then becomes a matter of replenishment.

(2) Under the general instructions as to the requirements of the theater and the policy as to priorities as determined by the commander of the field forces, the computation of detailed requirements and the replenishment of quartermaster supplies from the zone of the interior becomes a responsibility of the chief quartermaster on the staff of the commanding general of the communications zone.

(3) Replenishment requests or requisitions will take the form of a draft upon a designated port of embarkation within the zone of the interior, or will be made by direct requisition on the War Department.

(4) Normally, the War Department will establish credits in zone of interior depots for each port of embarkation for the exclusive use of a particular theater of operations, and upon which the commander of the forces may make direct calls. When such credits are established, they expedite supply, leaving the War Department free to handle the important matters of procurement in the zone of the interior and the broad matters concerning the administration of supply.

(5) The purpose of establishing credits is to eliminate unnecessary administrative procedure and thus to expedite the supply of articles in any class. Supplies earmarked as credits are considered in certain zone of interior depots at the disposal of the commanding general of the theater of operations for a definite period of time. These supplies are therefore subject to draft on demand direct from the commanding general of the theater of operations through his authorized representative, the commanding general, communications zone. This system assures a definite amount

of supplies for the period stated and at the same time tends to relieve the communications zone from the necessity of storing vast quantities of supplies in communications zone depots. At the end of the period stated in the credit grant, all undrawn balances revert to depot stock or, upon request from the commander of the theater of operations or his representative, a new credit may be arranged for a succeeding period. A copy of each credit set up is furnished the commanding general, theater of operations. The commanding general, communications zone, in turn furnishes the chief quartermaster on his staff with copies of credits pertaining to the Quartermaster Corps.

SECTION IV

WAREHOUSING

■ 34. GENERAL.—The details of warehousing are dependent to a large degree on the kind and amount of supplies and local warehouse conditions. Each situation constitutes a separate problem to be worked out locally in detail. It is essential that warehouse officers be capable of warehousing goods efficiently. They are the ones who are responsible for the conservation of space and manpower and for the speed of handling property.

■ 35. WAREHOUSE OFFICER.—*a.* This officer, who is in full charge of the warehouse, is an operations man and should not be burdened with administrative details. He should be aggressive, cooperative, and possess the necessary experience and background in warehouse operations. He is a vital link in the chain to move supplies to the field. He has the following responsibilities:

(1) To arrange for the proper storage, receipt and issue, packing, crating, inspection, and shipping of all property stored in the quartermaster warehouse.

(2) To plan warehouse lay-outs and allocation of space.

(3) To see that the transportation officer is furnished necessary information, in order that he may clear the carrier on incoming shipments and prepare bills of lading for all outgoing shipments.

(4) To see that accurate receiving and shipping records are prepared and furnished to the supply officer so that adequate stock records may be maintained.

(5) To exercise close supervision over the work of the entire organization.

(6) To plan well in advance so that all personnel concerned can become acquainted with the duties of a job before it presents itself.

(7) To organize and instruct his personnel. This is a continuous responsibility, and is so important that much effort should be given this assignment.

(8) To maintain constant vigil against loss of Government property by theft; plan and organize a fire fighting detail which will be constantly on the alert; and insist upon the removal of all fire hazards.

(9) To keep the warehouse neat and clean.

b. Arrangement of stock.—In warehousing supplies, arrangement should be such that—

(1) Supplies are reasonably secure against theft and protected from the deteriorating effects of weather, heat, light, moisture, and destructive effects of vermin.

(2) They may be readily removed for issue or shipment, and labor of handling is reduced to the minimum.

(3) They may be readily inspected and checked for inventory purposes.

(4) Waste space is reduced to the minimum consistent with efficient and economical operation.

(5) Maximum permissible floor load is not exceeded.

(6) Arrangement does not interfere with the free use of fire extinguishers and other fire fighting apparatus.

(7) Supplies are segregated by item and any subdivision of items, such as sizes, lots, or grades which may affect the proper conduct of an issue or inventory. The importance of carefully worked-out storage plans for storage areas cannot be overestimated. Intelligent planning ahead avoids subsequent inefficient operation due to poor utilization of space and avoids future rearrangement of stocks.

(8) Inflammable materials are segregated.

■ 36. MATERIALS-HANDLING.—Materials-handling is closely associated with space utilization and conservation and affect

each other. Handling methods should be carefully planned with consideration given to the type and amount of property, the space to be filled, the distance supplies are to be transported, and the mechanical equipment available. Available labor and equipment must be utilized in the best possible way. The warehouse officer must know the methods and application of each type of available mechanical equipment and know how to use it efficiently. The equipment can function properly only if well cared for. A well-equipped maintenance department is necessary to furnish frequent systematic inspection of the equipment and give it proper lubrication and repair. An equipment pool should be established for inactive equipment, that is, equipment in excess of that required for the average flow of work but which can be utilized in the event of an abnormal flow in any section or sections of the warehouse.

■ 37. LABOR POOL.—Because activity in each section of a warehouse is not the same from day to day, only enough skilled workers and laborers should be assigned to a section to handle its average flow of work. Excess labor should be assigned to the labor pool to be used in other sections having extra activities. Morale and spirit of the workmen are important. Unnecessary inconveniences to them should be avoided.

■ 38. RECORDS.—Too much stress cannot be laid on the importance of the original receiving records. The accuracy and reliability of the check against purchase orders, delivery tickets, and shipping tickets covering the property concerned have a direct bearing on the stock record account. To assure the accuracy of the record of stock received and shipped, a uniform system of checking and tallying has been adopted. As a result, accurate records are available to provide a means for the settlement of claims and the adjustment of any discrepancies that may appear.

■ 39. INVENTORY.—Inventories of the warehouse are necessary to correct the perpetual stock inventories kept by the stock control office. To facilitate inventories, similar types of merchandise should always be stacked in the same way

wherever possible. Odd cases or packages which do not fit into the standard stack should always be in the front of the pile. Deliveries should always be made from the front aisle end of the row.

■ 40. MISCELLANEOUS.—Other important functions for which the warehouse officer is responsible are—

- a. Systematic stowing of supplies.
- b. Proper piling.
- c. Proper aisle arrangement of main aisles, lateral stock aisles, fire aisles, connecting aisles, checking aisles, and blind aisles.

SECTION V

SUBSISTENCE

■ 41. ORGANIZATION.—Subsistence stores at posts, camps, and stations are handled through a sales commissary which normally functions under the direct supervision of a sales officer. His duties are prescribed in War Department regulations. Usually there are five branches in the commissary organizations: administrative, sales store, nonperishable warehouse, perishable warehouse, and bakery.

■ 42. REQUISITIONS.—Requisitions for subsistence stores are submitted to the depot designated for the supply of the post, camp, or station concerned.

■ 43. PROCUREMENT.—Procurement of subsistence supplies is made in accordance with the provisions of regulations. Further information with reference to procurement of supplies in general is given in section III.

■ 44. INSPECTION.—a. A proper inspection of subsistence stores requires a thorough knowledge of the authorized food articles. Federal and U. S. Army specifications and trade names or terms should be thoroughly understood.

b. The inspection of meat and dairy products is made under the supervision of veterinary personnel in accordance with instructions in Army Regulations.

■ 45. STORAGE AND ISSUE.—a. The officer charged with responsibility for subsistence supplies should have knowledge

of items requiring cool, dry or other favorable storage conditions, and of those which can stand less favorable storage facilities. Good warehousing is the systematic handling of supplies with a minimum amount of time and effort. Details will depend to a large degree on the kind and amount of supplies and local warehousing conditions. Each situation constitutes a separate problem to be worked out locally.

b. Subsistence stores in storage should be inspected frequently by the accountable officer for the purpose of determining their condition. Stores longest on hand should be issued, sold, or shipped first.

■ 46. SALES AND ISSUES.—*a. Classification of subsistence stores.*—Subsistence stores are classified as ration articles which are components of the ration. These and their substitutes are prescribed in Army Regulations for the subsistence of troops. Sales articles, which are articles authorized for sale in addition to ration articles, and exceptional articles, classified as confections, groceries, etc. (not component articles of the garrison or field ration and not shown on the authorized sales list) are also a part of the classification.

b. *Cash sales.*—Cash sales are made to individuals who are entitled to purchase in accordance with existing regulations. Charge sales are not made to individuals.

c. *Charge sales.*—Charge sales as well as cash sales are made to organizations entitled to purchase in accordance with existing regulations. A sales book register must be properly kept, the accounting for all books being made by serial number. A trial balance of all charge accounts must be made three times a month.

d. *Post bakeries.*—Post bakeries are operated by the quartermaster, usually under the supervision of the sales officer, and furnish the fresh bread for troops in garrison. The records kept at the bakery must be inspected and audited in accordance with regulations.

e. *Handling proceeds of sales.*—Sales officers must deposit funds with the disbursing officer in accordance with regulations. They must be deposited by the sales officer, a report of sales being prepared and delivered to the disbursing officer with the funds.

f. Rations.—A ration is the allowance of food for the subsistence of one person for 1 day.

(1) *Garrison ration.*—(a) The garrison ration is prescribed in peacetime for all persons entitled to a ration, except under specific conditions for which other rations are prescribed.

(b) The garrison ration is issued to troops in the form of a money allowance based on the current sales prices of the component articles of the garrison ration. Ration returns will be submitted on the first day of each calendar month for the preceding calendar month and at such other times and for such other periods as may be necessary.

(c) When troops are on a ration savings basis and are drawing a garrison ration, sales of subsistence stores are made to organizations. Subsistence supplies are normally drawn on a daily basis in accordance with requisitions submitted by each organization. The organization is not restricted to the purchase of articles of the ration.

(2) *Filipino ration.*—The Filipino ration is that prescribed in time of peace for Philippine Scouts.

(3) *Field ration.*—The field ration is prescribed for use only in time of war or national emergency, when the garrison ration is not used. It is issued in kind and no ration savings are allowed. Its components and substitutes are prescribed by the War Department or the commander of the field forces, and consist of the following:

(a) "Field ration A" corresponds in general to the peacetime garrison ration, and is generally perishable; it is not suitable as a reserve ration.

(b) "Field ration B" is the same as "Field ration A", except that nonperishable substitutes replace perishable items. This ration is suitable for reserve purposes.

(c) "Field ration C" is a cooked balanced ration in cans. Each ration consists of three cans of prepared meats and vegetables, and three cans of crackers, a confection, sugar, and soluble coffee. As this ration is not perishable, it is suitable for use as a unit reserve or as an individual reserve.

(d) "Field ration D" consists of three 4-ounce chocolate bars per ration. It is a nonperishable ration and is suitable for use as an individual reserve.

(e) "Field ration K" consists of three units, each containing one meal, packed in a rectangular container. This ration may be used to replace the C ration for special purposes.

g. Sales.—(1) Sales commissaries are stocked, in reasonable quantities, with such authorized articles of subsistence supplies as it may be practicable to keep on hand for sale to those entitled to purchase them.

(2) On the first day of each month, or whenever necessary, the sales officer computes a price list which is used in making all sales of subsistence supplies during the current month.

(3) At the close of business each day, the amount of charge and cash sales pertaining to each section of the store is determined.

(4) The sales officer must maintain a charge and cash sales register.

■ 47. PROPERTY ACCOUNTABILITY AND RESPONSIBILITY.—*a. Sales officer.*—The sales officer has charge of all subsistence stores (except stock at depots), and is accountable and responsible for all such stores. The accountability is kept by money value only, and is entirely distinct from the accountability of the quartermaster as evidenced by items listed on W. D., Q. M. C. Form No. 423 (Stock Record Cards). The sales officer functions under the direct supervision of the quartermaster.

b. Commanding officer.—The commanding officer is responsible and pecuniarily liable with the sales officer that the regulations in regard to the preservation, use, and issue of property are observed.

c. Inventories.—Two separate and distinct monthly inventories are made, reconciled, and recorded; one is made by the sales officer, and the other by a disinterested officer designated by the commanding officer.

d. Lost, destroyed, or damaged property.—This property will be accounted for in accordance with the provisions of Army Regulations.

e. Consumption record.—The consumption record is used in the preparation of annual and quarterly requisitions. A loose-leaf Stock Record form can be used for maintaining a record of consumption for all items carried in annual and quarterly stocks.

f. Accounting procedure.—The basic rule governing accounting for subsistence supplies in terms of money value requires that debits and credits be entered at current sales price. Where a change in sales price occurs (as in subsistence stores over the month end), the increases and decreases, multiplied by the items on hand at the time of such change, are reflected respectively as debits and credits. The inventory value of supplies determined prior to a price change, therefore, must be adjusted. Such adjustment is required for subsistence stores at the beginning of each month.

(1) *Sections of the account.*—(a) The account is divided into such sections as are required to meet local conditions and to avoid dual responsibility.

(b) A separate section is established for each appropriation or procurement authority. Supplies and services are accounted for in separate sections even though the same appropriation or procurement authority is involved. When instructions require allocation by purpose numbers of funds pertaining to the same appropriation or procurement authority, subsections are established to agree with the allocations.

(2) *Bakery account.*—Where a bakery is operated, a subsection is established under the subsistence account to cover that activity. At the end of the month, the account is balanced and the sales price of bread for the succeeding month is determined in accordance with regulations.

(3) *Articles used for care and preservation.*—Ice, twine, paper bags, wrapping paper, and charge and cash sales books which are consumed in connection with the care, issue, and sale of subsistence stores are dropped by money value on a certificate of expenditure signed by the sales officer and approved by the commanding officer.

g. Preparation of the account.—(1) The account is prepared each month by making debit and credit entries as follows:

(a) *Debit entries.*—Debit entries include the total money value of the inventory from the preceding month, inventory adjustment sales account (debit), supplies received by local purchase or by shipment from depots or other stations, and cash and charge sales accounts transferred from another

sales officer or from the quartermaster as a result of the sale of supplies and services.

(b) *Credit entries.*—Credit entries include inventory adjustment sales account (credit), shipments to other stations, vouchers for coffee lost in grinding, surveys, and issues; cash and charge sales (including accounts of supplies and services transferred to the sales officer), inventory of supplies on hand at date of inventory, and deductions under allowances of $\frac{3}{10}$ of 1 percent, or surveys where total loss exceeds $\frac{3}{10}$ of 1 percent.

(2) Each voucher is entered in terms of total money value computed at the current sales price.

h. Control of account.—In addition to the account and supporting vouchers forwarded to the finance officer for audit, each sales officer maintains the following records which are not forwarded but are filed with and form a part of each month's records.

(1) *Daily record of sales.*—This record shows for each day on which sales were made, the date, the section or subsection and the amount of charge and/or cash sales. Cash collections made during the first 10 days of the month for charge sales made during the preceding month are also recorded. The entries are made at the close of each day's business by the sales officer *in person*, who retains the record in his possession at all times.

(2) *Voucher register and general control.*—(a) This record shows the date, voucher number, brief description of each voucher, section or subsection to which it pertains, and the money value entered as required, either in the debit or credit column or both.

(b) At the end of the month's business, the sum of the debits and credits (taken separately) as they appear on the voucher register and general control should equal the total of the debits and credits (taken separately) of the individual section accounts computed before any balancing (gain or loss) entries are made. This affords a check on the month's work as a whole. Entries in this record are made by the sales officer or his principal assistant. When the record is maintained by the principal assistant, the sales officer indi-

cates verification of each entry by his initials at the time the supporting voucher is authenticated.

(3) *Record of procurements.*—A blotter record of procurements is maintained by the sales officer or an assistant. The entries in this record are verified and initialed at the time the sales officer signs each purchase order and receiving report. At the close of the month, the sales officer checks this record to see that a formal purchase instrument has been issued to cover all supplies ordered informally, and that receiving reports have been prepared for all supplies received. The record of any transaction not completed by the receipt of the supplies and the preparation of a receiving report is transferred to the record of procurements pertaining to the succeeding month.

■ 48. **QUARTERMASTER SALES COMPANY.**—The quartermaster sales company is designed to sell designated items of merchandise, such as cigars, cigarettes, razor blades, shaving cream, etc., to troops in theaters of operations. They are small articles not normally supplied from other sources and, although not a necessity, are vital to the welfare and morale of the troops. The company consists of three platoons of four sections each. The section is the basic operating unit and is equipped with two 2½-ton cargo trucks and two 1-ton two-wheel trailers. Each section has enough sales capacity to serve 10,000 men a day. Sections are normally assigned to combat divisions and will operate mobile sales stores in rest areas and areas occupied by corps and army troops. When so attached or in operation, their activities are controlled by the quartermaster or commander of the unit to which they are attached, or in whose area they are operating.

SECTION VI

SALVAGE

■ 49. **GENERAL.**—*a.* The administrative details governing salvage activities in the zone of the interior are contained in Army Regulations and other publications issued by the War Department.

b. Salvaged materials may consist of condemned property and waste materials accumulating within the Army or they

may consist of materials found on the battlefield, captured from the enemy, or abandoned by our own troops.

c. Salvage activities are functions of the Quartermaster Corps. They are performed under the supervision of officers of the quartermaster service detailed as salvage officers.

d. The object of salvage reclamation is to effect economy in tonnage of shipments from the zone of the interior and to conserve raw materials. This will result in the conservation of military resources.

e. In the disposition of salvaged property, the first consideration is utilization within the Army. Property which is condemned as unserviceable by one arm or service may often be used to advantage by another arm or service. Also, many items may be repaired economically in quartermaster shops and returned to stock for reissue; or the basic materials may be used to manufacture other needed articles in quartermaster shops provided for that purpose. Some of the accumulation may be sold, and that which has no reclamation value will be destroyed.

■ 50. ORGANIZATION.—The following military units are provided: a salvage collecting company, a quartermaster salvage repair battalion, semimobile, and a headquarters, quartermaster salvage depot.

a. *Salvage collecting company.*—The salvage collecting company is organized with a company headquarters and three platoons of two sections each. The company headquarters perform the usual military, administrative, supply, and messing duties, and supervises the technical operations of the company as a whole. Each platoon has sufficient personnel to sort and classify salvage from a combat force of 25,000 men; the company can serve a force of 75,000 men. Additional labor, if required, is furnished by quartermaster service units. Attached to the company are seven enlisted men each from the Ordnance Department, Chemical Warfare Service, and Signal Corps, who function in an advisory and technical capacity for salvage matters which pertain to their respective services.

b. *Quartermaster salvage repair battalion, semimobile.*—The quartermaster salvage repair battalion, semimobile, is composed of a battalion headquarters, a quartermaster sal-

vage repair company, semimobile, a laundry company, semimobile, and a sterilization company.

c. *Headquarters, quartermaster salvage depot.*—The headquarters, quartermaster salvage depot, provides the administrative, mess, technical and other overhead personnel required for operation of the salvage depot. It consists of the following divisions:

- (1) Depot headquarters.
- (2) Company headquarters.
- (3) Administrative and supply division.
- (4) Receiving and regulating division.
- (5) Clothing repair division.
- (6) Shoe, leather, and rubber repair division.
- (7) Laundry and sterilization division.
- (8) Canvas and webbing repair division.
- (9) Machinery and metal repair division.
- (10) Waste disposal division.
- (11) Storage and shipping division.

■ 51. OPERATION.—Quartermaster salvage operations include the collection, evacuation, classification, and disposition of all waste materials, abandoned property, condemned property, and unserviceable supplies. Explosives, ammunition, or component parts thereof containing explosives, and such other supplies as are exempted by the commander, are not included in quartermaster salvage operations. Field salvage operations are directed by the salvage officer of the command, under the quartermaster.

a. *Salvage collecting company.*—(1) The mission of the salvage collecting company, semimobile, is the receipt, collection, and basic classification of all classes of salvage at collecting points, dumps, and railheads. The salvage is then evacuated to quartermaster repair shops and depots, or to the dumps, depots, and repair shops of the other arms and services. All salvage handled by the company (including serviceable items) will be returned to quartermaster repair companies, quartermaster salvage depots, quartermaster depots, or to depots of the other arms and services, depending upon the nature of the salvage. The company will not reissue any articles of salvage.

(2) Troop commanders are responsible for the collection of salvage from the battlefield and occupied areas, and for its delivery to designated points (usually the supply point for class I supplies). From the collecting points, the salvage is then gathered by the salvage collecting unit and evacuated to the rear.

(3) Salvage evacuated from the combat zone is sent to salvage depots in the communication zone where it is sorted, classified, and reclaimed by repair. The articles beyond repair are classified for reclamation as raw materials for reuse in manufacturing.

b. *Quartermaster salvage repair battalion, semimobile.*—The quartermaster salvage repair battalion, semimobile, sterilizes, cleans, repairs and sends salvaged clothing, shoes, textiles, canvas, rubber, and other quartermaster articles to issuing depots. It will not perform these functions for individuals. The battalion can handle the salvage expectancy of a force of 50,000 troops. Articles that are repaired will be sent to a quartermaster depot for reissue. Irreparable articles and waste materials will be sent to a salvage depot or to the base quartermaster for proper disposition. The component parts of the battalion are as follows:

(1) *Quartermaster salvage repair battalion, headquarters detachment.*—The battalion headquarters detachment coordinates and directs the activities of the three companies that make up the battalion. It performs the general administrative duties of a battalion headquarters.

(2) *Quartermaster sterilization company.*—The sterilization company when operating as a part of the salvage repair battalion, semimobile, sterilizes the salvage received by the battalion. It will not sterilize clothing or equipment for return to individuals. The company consists of a company headquarters, a supply and salvage section, and two platoons. Each platoon contains a platoon headquarters and two sterilizer sections.

(3) *Quartermaster company, laundry, semimobile.*—The laundry company, semimobile, when operating as a part of the salvage repair battalion, washes the salvage received by the battalion. It will not perform laundry work for individuals. The company consists of a company headquarters

and four platoons. Each platoon contains a platoon headquarters and two laundry sections.

(4) *Quartermaster salvage repair company, semimobile.*—The salvage repair company repairs and reclaims for reissue clothing, shoes, webbing, canvas, textiles, rubber and such other equipment as the facilities of the company will permit. The company consists of a company headquarters and two platoons. Each platoon contains a platoon headquarters, and shoe, clothing, and textile repair sections.

c. *Quartermaster salvage depot.*—The quartermaster salvage depot in the theater of operations reclaims all property not reclaimed by other services. It generally is located in the base section of the communications zone. The military personnel required for the operation of the salvage depot is provided by headquarters, quartermaster salvage depot. The headquarters is divided into the following, the first three divisions being administrative:

(1) *Depot headquarters.*—The quartermaster salvage depot is headed by a commanding officer of the depot, who coordinates the activities of the several divisions of the depot. He executes the instructions of higher command on matters relating to the depot. He is assisted by an executive officer, an adjutant, and a chief clerk.

(2) *Company headquarters.*—The company headquarters at the depot is responsible for the records, mess, supply, and transportation for the depot.

(3) *Administrative and supply division.*—The administrative and supply division maintains the records and performs the military and technical paper work incident to the operation of the depot and its personnel. It is responsible for receiving, storing and shipping, and requisitioning and accounting for all operating supplies used in reclamation and depot maintenance. It maintains the buildings, grounds, and machinery, and operates the power and heating plant at the depot.

(4) *Receiving and regulating division.*—The receiving and regulating division receives, classifies, and distributes to the various repair branches all quartermaster clothing and equipment received at the depot.

(5) *Clothing repair division.*—The clothing repair division repairs all textiles with the exception of canvas and webbing.

(6) *Shoe, leather, and rubber repair division.*—The shoe, leather, and rubber repair division reclaims for reissue rubber boots, arctics, raincoats, and all items of leather.

(7) *Laundry and sterilization division.*—The laundry and sterilization division sterilizes and launders all items of salvage requiring such treatment, and routes them to the appropriate division for repair.

(8) *Canvas and webbing repair division.*—The canvas and webbing repair division reclaims tentage, paulins, leggings and other canvas items of webbing equipment, and raincoats.

(9) *Machinery and metal repair division.*—The machinery and metal repair division repairs mechanical equipment, animal-drawn transportation, tools, laundry and bakery equipment, and other supplies fabricated from metal.

(10) *Waste disposal division.*—The waste disposal division disposes of waste materials and irreparable items.

(11) *Storage and shipping division.*—The storage and shipping division receipts for all repaired articles from the repair divisions, and is in charge of their storage and shipment to depots for reissue.

SECTION VII

REMOUNT SERVICE

■ 52. **GENERAL.**—The mission of the Remount Service is to insure the supply of a sufficient number of horses, mules, and dogs suitable for military use. It purchases horses, mules, dogs, and the forage and feed required to condition and train them; and issues conditioned and trained animals to the using arms as they may be required. The animals procurable upon mobilization must have been bred in time of peace; for this reason, and because the wartime organization is similar to that in time of peace, the peacetime organization and operation of the remount service is outlined in connection with its organization and functions in time of war.

■ 53. **ORGANIZATION.**—The remount organization consists of the Remount Service, Office of The Quartermaster General, and of remount areas and depots.

a. Remount Service.—The Remount Service of the Office of The Quartermaster General supervises all remount operations.

b. Remount areas.—Geographically, the United States is divided into seven remount areas. Each area has a headquarters office at a suitable location within the area. In time of peace, the personnel of a remount area headquarters consists of an officer in charge, a headquarters veterinarian, a chief clerk, a stenographer, and a groom. In time of war, the personnel is enlarged in order to cope with the increased demand for animals. At such time, the area headquarters will have a quartermaster. The officer selected for the position of quartermaster should preferably be an experienced horseman, or one of adaptability and enthusiasm for remount work. With such qualifications he can be further trained in theory and practice for the purpose of assisting the officer in charge, later taking over the duties of this officer. Assigned to the several remount area headquarters are purchasing boards. The officer in charge of each board will be an experienced horseman. Each purchasing board will consist of one officer, Quartermaster Corps; one officer, Veterinary Corps; one clerk, and one messenger-chauffeur. Activities will be expanded in time of war to meet the increased demands. The officer in charge of each remount area is responsible for the economical administration of the Army horse-breeding plan and for the procurement of animals in his area.

c. Supervision of Army horse-breeding plan.—The supervision of the Army horse-breeding plan includes—

(1) Inspecting applicants who wish to act as agents in caring for stallions to determine whether or not the applicants have proper facilities and are reputable citizens in their communities.

(2) Obtaining information as to the type of stallion desired and the number and type of mares to be bred.

(3) Placing stallions with agents.

(4) Inspecting stallions assigned to agents to determine their care and condition, suitability of their offspring, and to give necessary instructions to agents and owners of mares with reference to the best technique and practices in horse breeding, and care and development of foals up to 4 years of age.

d. Procurement.—It is the policy of the remount service in peacetime to purchase animals direct from breeders. This

eliminates the broker, and allows the breeder to get a better price for his stock. This also encourages him to breed better animals, and gives the purchasing officer first-hand information of horse conditions in his area. In time of emergency, animals will also be purchased from dealers to such an extent as may be necessary:

e. Remount depots.—The general functions of a remount depot are to provide—

(1) Places where newly purchased animals can be sent and economically maintained while being trained and conditioned for issue.

(2) For economical holding of private mounts of officers who are on foreign service, or when authorized by competent authority.

(3) Places for holding stallions during the nonbreeding season, for testing and training stallions before placing them in public service, and for breeding a limited number of horses to—

(a) Demonstrate to breeders the type of riding horses the Army requires and how they are produced.

(b) Instruct personnel in breeding technique to provide a background in horse breeding for officers on duty with remount service.

(c) Produce stallion and brood mare replacements.

(d) Produce a few high-class horses for special purposes.

(e) Conduct research in horse and mule diseases and preventive veterinary medicine.

(f) Experiment with and perfect feeds, substitute feeds, and methods of feeding.

(4) The purchase of animals, when specially authorized.

(5) Train remount officers in animal administration duties in the remount breeding scheme.

■ 54. EXPANSION AND OPERATIONS UPON MOBILIZATION.—*a. General.*—In event of an emergency the number of remount areas remains the same, but additional purchasing boards are set up in each area as conditions may demand.

b. Depots.—The three peacetime remount depots continue normal peacetime operations and expand to take care of a proportion of the additional animals purchased. In addition, schools are conducted for training of remount personnel.

(1) *Additional depots.*—Additional remount depots as required will be established at suitable locations. These remount depots will conduct no breeding, but will receive, condition, and issue animals that have been purchased.

(2) *Issue of animals.*—The issue of animals from these remount depots will be direct to troops or to other remount depots in the zone of the interior, and to field remount depots established in the theater of operations. They will be issued only upon properly approved requisitions. Selection of animals to be issued will be made by the depot commander or his authorized representative. Great care will be exercised that none but fit, sound, and suitable animals are issued. Before issue all animals will be given a physical examination by the depot veterinarian.

(3) *Control in zone of the interior.*—The control of animals by the remount service in the zone of the interior ceases when they are issued to troops or to remount depots in the theater of operations. The control of remount activities by The Quartermaster General through the remount division is confined to the zone of the interior.

(4) *Operation in zone of the interior.*—Remount depots in the zone of the interior will be operated by remount troops and such civilian personnel as may be required.

■ 55. THEATER OF OPERATIONS.—*a.* Remount depots in the theater of operations are branch depots and will be controlled in the same manner as other quartermaster depots. When the location and depth of the theater of operations warrant it, there will be established in the communications zone necessary debarkation remount depots, base remount depots, and advance remount depots. Within the combat zone, there will be established remount depots in the army or in the corps as required. All remount depots in the theater of operations will be operated by remount troops.

b. The functions of remount depots in the theater of operations are to receive animals from the zone of the interior and issue them to the using arms, and to receive evacuated animals for reconditioning or for further evacuation to remount depots in the zone of the interior. (See FM 25-5.)

CHAPTER 4
TRANSPORTATION

	Paragraphs
SECTION I. Motor	56-62
II. Animal	63-67

SECTION I

MOTOR

■ 56. GENERAL.—Motor transport is an important part of an organized transportation system. It is made available to a commander to afford freedom of action in accomplishing the required movement of supplies and in affording means of rapid maneuver of combat elements. Of all methods of transportation capable of handling the large quantities of supplies involved, motor transport is the most flexible. It permits the maneuver of troops and supplies in any direction at the will of the commander. But wherever possible, motor transport should be used as an aid to rail and water transportation, supplementing rather than replacing them, as there are many disadvantages in the use of motor transport. Continuous operation of motor transport requires well-constructed roads, and yet is very destructive to those roads. This materially increases the labor and materials required for road construction and maintenance. Personnel required for motor transport operation, on a ton-mile basis, is many times that required in rail operation. Motor transport cannot be operated efficiently at the low speed of marching troops. It must either use parallel routes or be restricted to specified periods of time on congested roads. The adoption and availability of all-wheel and multiple-wheel-drive vehicles have provided motor transport capable of cross-country mobility. The limitations imposed on speed and performance and the great wear and tear resulting to equipment under these conditions must be carefully considered by commanders before extensive cross-country operations are di-

rected. Continual operation must be supported by adequate maintenance and comprehensive inspection.

■ 57. **EMPLOYMENT.**—Two methods of using motor vehicles are generally practiced. They are as follows:

a. Assignment.—This method assigns a vehicle or a group of vehicles to one user, and as a result they are not available to others during the entire period of such assignment. Assignment is used primarily for organic transport and combat vehicles of organizations, and is the normal method of employment applicable to units such as a company, battery, or troop. This method is also used when the work to be performed requires special vehicle characteristics.

b. Pooling.—In this method, a central agency is created through which motor vehicles are dispatched to perform a designated task or tasks. It permits the working of one or more vehicles on one or more jobs. By proper planning, it provides maximum loads and economizes hauling mileage, thereby avoiding wasted effort. It is applicable to command groups which require services of motor transport beyond the capacity of organic equipment in the hands of individual units. It is also particularly useful in the operation of general purpose transport.

■ 58. **ORGANIZATION.**—Motor transport is a utility available for meeting the service needs of all arms. Economy of available motor equipment demands that organically assigned general purpose vehicle equipment, as distinguished from combat vehicles, be limited in lower echelons of command to the least required for normal "housekeeping" purposes, with such additional vehicles as are determined to be necessary by command decision to meet a general situation operated in pools to meet peak demands or perform special missions. The actual need of a unit for motor transport services above its normal requirements is dependent on many factors. These include the mission of the command, the length of haul, the kind and condition of the road net, and expected developments in the tactical or strategical situation. No situation can be considered an average situation, and usually no two situations have the same requirements, but each must be provided for by command action. The organization of

motor transport, therefore, must be flexible and adaptable to operation in a vast variety of unit combinations. The successful accomplishment of the mission of motor transport depends on proper vehicle performance.

■ 59. PERFORMANCE.—The combination of the operator's ability and the mechanical condition of the individual vehicle are important factors in a mass motor movement. The operating officer must know the actual limitations of his personnel and vehicles. Inexperienced, careless, or poorly trained operators, or poor condition of vehicles resulting from age or deferred maintenance, or a combination of these factors, can upset all plans for successful completion of an assigned task. Personnel performance depends on degree of mechanical skill, health, fatigue, and morale. Vehicle performance differs considerably under varying conditions of actual field operations. Speed, types of fuel and oil, overloading, terrain and climatic conditions, all effect performance.

■ 60. ADMINISTRATION.—The functions of the administrative echelon include direction of the tactical employment of the operating units and the management of the actual operations. In any command group, the commanding officer is the authority who directs the character of load, time and place of loading, destination, and priority of the movement. The commander of the motor transport units to which the mission is assigned is responsible for the actions required to carry out the transport services directed. Technical considerations dictate that a minimum of limitations be placed on the manner in which the motor transport commander disposes of the equipment available to him in performing the mission.

■ 61. OPERATION.—The motor transport pool within a command group need not be grouped physically in one place. Pooling is effected by placing motor transport elements under the control and direction of a single authority usually in the administrative echelon referred to in paragraph 60. The various elements should be dispersed throughout the area in accordance with the necessity for their use. Billeting of operating units should place them in proximity to the area

in which they are to be used. Adequate communication must be provided, preferably by telephone, between control and subordinate elements. The means provided for the control and use of motor transport must insure sufficient elasticity to meet any situation. Normally, the pool will function in its sector as a utility in the movement of specific troop units and cargo tonnage between stated terminals and under priorities determined each day by the proper commander. Occasionally, when the situation affecting a subordinate unit cannot be foreseen, especially during an advance, motor transport units may be attached temporarily to the unit for the duration of a specific operation. Under special conditions, it may become necessary for motor transport to assume the characteristics of rail transport, operating over fixed routes on prearranged schedules for extended periods of time. This type of operation requires rigid technical administrative control.

■ 62. MAINTENANCE.—*a.* The Quartermaster Corps is responsible for the transportation of the Army by motor. This includes the transportation of troops and supplies. To accomplish this mission, the Quartermaster Corps has assigned to it truck companies and regiments. Successful and efficient operation depends upon the care and maintenance given each motor vehicle. This is very important and should never be overlooked. It is absolutely necessary that commanding officers of operating organizations and their personnel know and understand the requirements and problems involved in motor maintenance. Maintenance must start with the individual driver. Driver maintenance must be subjected to supervisory inspection in order to determine the need for any further corrective measures. Drivers and assistant drivers must be alert, careful, and thoroughly schooled in the basic rules of driver training and preventive maintenance. Motor maintenance is divided into echelons. Each echelon is differentiated by its functions. Repairs will be performed in the lowest echelon consistent with the availability of tools, parts, time, the capabilities of mechanics, and the tactical situation.

b. Organizations and individuals are responsible for organizational maintenance. This term is used to fix the re-

sponsibilities for certain maintenance functions on organizations and individuals charged with the operation and driving of motor vehicles. All operating units and organizations are equipped with the necessary tools and supplied with the necessary mechanics and motor parts suitable to perform the motor maintenance functions required of them. Organizational maintenance and the responsibility therefor is divided into the following:

(1) *Driver maintenance (first echelon)*.—This echelon performs preventive maintenance functions, and is the principal factor upon which the life of motor vehicles depends. The driver and assistant driver are charged with the performance of the duties and tasks included in this echelon. These include servicing, lubricating, cleaning, tightening, care of tools, equipment, tires and battery, and the making of emergency repairs. These are the minimum responsibilities charged to this echelon. The company or detachment commander is responsible for their efficient performance. (See FM 25-10.)

(2) *Company maintenance (second echelon)*.—Companies and detachments perform preventive maintenance functions. They are charged with performing the scheduled maintenance services described in FM 25-10, and include as a minimum the making of minor repairs, minor unit replacements, and lubrication. Responsibility lies with the company or detachment commanders to which the vehicles are assigned.

(3) *Battalions and regiments, detachments and separate companies (second echelon)*.—These organizations are charged with the maintenance functions set forth above but not performed by the company. They are responsible for the performance of the scheduled maintenance services described in FM 25-10, limited unit replacement, supply, battlefield recovery, and evacuation to higher echelons. The responsibility lies with the appropriate organization commander to which the vehicles are assigned.

SECTION II

ANIMAL

■ 63. GENERAL.—Animal transportation is divided into wagon and pack. It will be used only in situations where motor

transportation is impracticable or less economical. Wagon service is furnished by Quartermaster Wagon Company, T/O 10-127, and the Quartermaster Wagon Battalion, T/O 10-125. Pack service is furnished by the Quartermaster Pack Troop (Company), T/O 10-118.

■ 64. WAGON TRANSPORTATION.—*a. Advantages.*—Wagon transportation has the following advantages:

(1) It can travel over terrain impracticable for motor transportation.

(2) The capacity of a wagon is comparable to that of a light truck and equal to the pay loads that can be transported on at least 12 pack animals.

(3) The maintenance of a wagon is relatively simple.

(4) The required animals can sometimes live off the country.

b. Disadvantages.—The following disadvantages restrict the use of wagon transportation:

(1) It is slow, moving at $3\frac{1}{2}$ miles per hour, or slower.

(2) Its daily marches are limited to about one-eighth of the distance which motor transportation can travel.

(3) The forage requirements of its animals (amounting to about 100 pounds daily for the four animals per wagon) when carried on vehicles, materially reduce the pay load (other cargo), especially on trips extending several days' distance from the supply base.

(4) Forage requirements, when grazing is impracticable, necessitate voluminous and frequent replenishments, and the animals require laborious care even when the transportation is idle.

(5) During an active campaign, animals soon became un-serviceable as a result of one or a combination of the following: insufficient water or forage, excessive marching, or neglect due to inexperienced or careless personnel.

c. Employment.—Wagon transportation will be employed only to meet the needs of special situations, some of which are listed below.

(1) Over terrain affording few or no roads suitable for motor transportation, including—

(*a*) Long distances entirely impracticable for motor transportation.

(b) Short distances in extension of routes practicable for motor transportation.

(c) Short distances paralleling and supplementing routes being used to capacity by motor transportation; for example, in a concentrated area where mass motor movements of troops and supplies in preparation for an offensive are in progress on all available motor roads.

(2) Over terrain temporarily impassable for motor transportation as a result of—

(a) Rainy weather.

(b) Artillery shell holes, aerial bomb pits, etc.

(3) In theaters of operations where the use of wagon transportation would be more economical than the use of motor transportation, because of—

(a) Abundant local resources of animals, wagons, and forage.

(b) Hostile interference by sea, air, or land, making replenishment of motor fuel and parts difficult.

(4) In other situations where motor transportation is not available and idle wagon transportation can accomplish the tasks.

(5) At remount depots.

■ 65. PACK TRANSPORTATION.—*a. Advantages.*—(1) The principal advantage of pack transportation, and usually the sole reason for its existence, is that it can traverse terrain impassable for motor and wagon transportation.

(2) Animals sometimes can obtain forage by grazing.

(3) In certain situations, because of the small silhouette of its animals and the dispersive capabilities of its organization, pack transportation is less vulnerable than vehicular transportation.

b. Disadvantages.—(1) The forage requirements of its animals, when forage must be carried by the animals, reduces the pay loads of other cargo so much that it makes pack transportation very uneconomical.

(2) It is slow, moving $4\frac{1}{2}$ to 5 miles per hour.

(3) It has other disadvantages inherent in animal transportation as mentioned in paragraph 61.

c. Employment.—(1) Pack transportation should be employed in situations where the use of vehicular transport is impracticable, some examples of which are listed below:

(a) In mountain or jungle country, and on narrow trails.

(b) In connection with the cross-country supply of troops in combat, especially over shell-torn or difficult terrain impassable for vehicular transportation.

(c) Over terrain temporarily impassable for vehicular transportation as a result of rainy weather.

(2) The employment of pack transportation usually is a recognition of the dire need for supplies by troops who cannot be reached by any other means of transportation. In such cases, excessive distances, night travel, extreme privation, and any other difficulties that can be overcome by determined effort should not be permitted to deter pack transportation from reaching its march objective by the time specified. The most economical use of pack transportation is for short distances beyond the routes practicable for vehicular transportation, where the round trip for the pack animals is not over a day's march.

■ **66. ANIMAL CASUALTIES.**—*a. Treatment.*—In camp, animal casualties are examined and treated at veterinary dispensaries. On the march, veterinary personnel are distributed throughout the column so that they can promptly detect and examine casualties, give them necessary treatment, and determine the disposition to be made of them.

b. Evacuation.—Severe casualties which are unable to walk are collected in ambulances and evacuated to the nearest evacuation hospital. Other casualties which are able to walk are evacuated by marching or by rail in the stock cars used to bring animal replacements forward.

■ **67. ANIMAL REPLACEMENT.**—*a.* The system of animal replacement must insure the timely arrival of animals where they are needed.

b. Establishments for handling animal replacements are echeloned in depth. They include the corps remount depot when the corps is acting independently, and Army remount

depots, and such other base and advanced remount depots in the communications zone as may be necessary.

c. Animal replacements are forwarded to units by rail, motor, or water transportation, or by marching; movement beyond railheads normally is executed by marching. (See FM 25-5.)

CHAPTER 5

QUARTERMASTER SERVICE IN DIVISIONS AND HIGHER
UNITS

	Paragraphs
SECTION I. General.....	68-70
II. Infantry division.....	71-73
III. Cavalry division (horse).....	74-75
IV. Armored division.....	76-79
V. Mountain division.....	80-81
VI. Motorized division.....	82-83
VII. The corps.....	84-89
VIII. The army.....	90-94
IX. The air force.....	95-97
X. Theater headquarters.....	98-101

SECTION I

GENERAL

■ 68. GENERAL.—*a.* In the theater of operations, the function of the Quartermaster Corps is to supply the services essential to the well-being of the unit concerned. These services closely parallel those enumerated in chapter 1.

b. The strength and composition of the quartermaster service of a theater of operations and within each subordinate command depends on the organization of the theater of operations and the functions and missions of each subordinate command. Deficiencies in any subordinate unit are met by the assignment of quartermaster personnel and units from higher headquarters.

■ 69. DEFINITIONS.—See FM 100-10.

■ 70. CLASSIFICATION OF QUARTERMASTER UNITS.—*a.* Quartermaster units include companies, troops, battalions, squadrons, and regiments. The composition, strength, and mission of the command to be served determines the number of each type of units that should be assigned.

b. Units required to perform the quartermaster mission in the theater of operations are classed as supply, transportation, and service.

- (1) The supply group consists of the following units:
 - (a) Quartermaster companies, infantry divisions (T/O 10-17).
 - (b) Headquarters troops cavalry (horse), quartermaster squadrons (T/O 10-116).
 - (c) Depot companies, supply (T/O 10-227).
 - (d) Bakery battalions and companies (T/O 10-145 and 10-147).
 - (e) Headquarters companies, supply battalions, armored divisions (T/O 10-36).
 - (f) Supply battalions, armored divisions (T/O 10-35).
 - (g) Refrigeration companies (T/O 10-217).
 - (h) Refrigeration companies, mobile (T/O 10-247).
 - (i) Remount squadrons and troops (T/O 10-95 and 10-97).
 - (j) Sales companies (T/O 10-157).
 - (k) Headquarters companies, mountain, quartermaster battalions (T/O 10-336).
 - (l) Quartermaster battalions, mountain divisions (T/O 10-335).
 - (m) Headquarters companies, motorized, quartermaster battalions (T/O 10-316).
 - (n) Quartermaster battalions, motorized divisions (T/O 10-315).
 - (o) Quartermaster companies, air base (T/O 10-357).
 - (p) Quartermaster platoons, supply base (aviation) (T/O 10-417).
 - (q) Quartermaster companies, service group, aviation (T/O 10-437 RS).
 - (r) Quartermaster depot companies, class III aviation (T/O 10-467).
 - (s) Quartermaster platoon, air depot group (T/O 10-427).
 - (t) Quartermaster depot subsistence companies, aviation (T/O 10-477).
 - (u) Gasoline supply battalions and companies (T/O 10-75 and 10-77).
 - (v) Airborne quartermaster companies (T/O 10-327).
 - (w) Headquarters companies, quartermaster battalions, engineer amphibian brigades (T/O 10-276).
 - (x) Quartermaster battalions, engineer amphibian brigades (T/O 10-275).

- (y) Railhead companies (T/O 10-197).
 - (2) The transportation group comprises—
 - (a) Truck regiments, battalions, and companies or troops (T/O 10-51, 10-55, 10-37 and 10-57).
 - (b) Truck companies and platoons, aviation (T/O 10-517 and 10-518).
 - (c) Car companies (T/O 10-87).
 - (d) Pack troops (T/O 10-118).
 - (e) Wagon battalions and companies (T/O 10-125 and 10-127).
 - (3) The service group comprises—
 - (a) Graves registration companies (T/O 10-297).
 - (b) Laundry battalions and companies, semimobile (T/O 10-165 and 10-167).
 - (c) Laundry platoons, hospital (T/O 10-287).
 - (d) Salvage collecting companies (T/O 10-187).
 - (e) Service battalions and companies (T/O 10-65 and 10-67).
 - (f) Sterilization battalions and companies (T/O 10-175 and 10-177).
 - (g) Quartermaster salvage repair companies, semimobile (T/O 10-237).
 - (h) Quartermaster headquarters, salvage repair battalions, semimobile (T/O 10-236).
 - (i) Headquarters, quartermaster salvage depots (T/O 10-250).
- c. The details as to assignments of personnel, major items of transportation, weapons, and animals of quartermaster units are indicated in Tables of Organization for the various units.

SECTION II

INFANTRY DIVISION

■ 71. GENERAL.—Certain service organizations have been assigned to the infantry division to relieve the combat troops of the responsibility for administrative details. The quartermaster company is one of these units. It is designed to accomplish the quartermaster services necessary to the infantry division. A quartermaster airborne company performs these services for the airborne division. A battalion

performs these services for the armored division, the mountain division, the motorized division, and the engineer amphibian brigade. Personnel and units trained in the technique of quartermaster administration, supply, transportation, and other assigned activities are furnished by the unit concerned.

■ **72. QUARTERMASTER COMPANY, INFANTRY DIVISION.**—This company consists of the office of division quartermaster, a company headquarters, a service platoon, and three truck platoons. The company headquarters performs the normal housekeeping duties of a company headquarters including administration, mess, and second echelon motor maintenance. The service platoon furnishes the labor for handling supplies, and is the nucleus of the division labor pool. The three truck platoons furnish the transportation necessary to carry the authorized division supply reserve. It also provides transportation for the movement of supplies and troops, and forms the nucleus of the division motor pool.

a. Division quartermaster.—The division quartermaster supervises the training and operations of the company. He is a staff officer on the special staff of the division commander. As division quartermaster, he is responsible for the efficient operation of quartermaster service of the division in accordance with policies and decisions of the division commander. As a division special staff officer, he performs those duties enumerated in chapter 1.

b. Assistant division quartermaster.—The duties of the assistant division quartermaster are determined by the division quartermaster.

c. Company commander.—The company commander performs the normal duties of the commander of a company. He is responsible for the administration of the company and its efficient operation in accordance with the policies and decisions of the division quartermaster.

d. Division quartermaster's office.—The office of the division quartermaster is organized to facilitate the direction, administration, and operation of quartermaster activities for the division as a whole. There is no prescribed organization of a division quartermaster's office, and any organization

that adequately serves the needs of the company and the division will be satisfactory. It has been found workable to group all duties under three divisions: administrative, supply, and transportation.

(1) *Administrative division.*—The principal functions of the administrative division are:

(a) Preparation of plans and orders for the quartermaster service of the division.

(b) Coordination of the execution of such plans and orders.

(c) Maintenance of the office of record for the division quartermaster as a special staff office.

(d) Quartermaster Journal.

(e) Collection of historical data and the preparation of operation reports.

(f) Preparation of estimates for funds.

(g) Control of the allotment of funds.

(h) Accounting for funds.

(i) Administration of quartermaster service of the division graves registration.

(j) Control of the labor pool (employment of service company and any attached service troops).

(2) *Supply division.*—This division operates under the division quartermaster supply officer. The supply division—

(a) Provides and plans for the distribution of all quartermaster supplies and remounts within the division.

(b) Directs the operation of attached supply units, such as salvage, sterilization, sales, bakery, etc.

(c) Maintains essential statistics of quartermaster supply operations.

(d) Supervises the collection and disposition of salvage materials.

(3) *Transportation division.*—This division operates under the division transportation officer, who is also the purchasing and contracting officer. The principal functions of this division are to—

(a) Provide for the transportation of troops and supplies, including the necessary arrangements therefor.

(b) Direct and supervise the employment of the transportation of the quartermaster company.

(c) Provide technical advice and assistance to the division quartermaster on all matters relating to the operation of motor and animal transportation within the division, including training of personnel in such matters.

(d) Provide dispatching service for the division transportation pool when established.

■ 73. QUARTERMASTER OPERATIONS, INFANTRY DIVISION.—*a. Basis of supply.*—In a division whose trains are motorized, supply operations for all classes are based on these supplies being hauled either in regimental or in divisional transportation from army supply points to the using troops. Normally, they are not transferred to other trucks or placed in dumps from the time they are received from the army supply points until they are delivered to the using troops. Basing his decision on consideration of the tactical situation, reserves carried, probable expenditure rate, distances involved, routes available, and restrictions imposed by higher authority, the division commander determines the degree of responsibility that will be placed on subordinate commanders for effecting resupply with their own transportation. The division commander must be sure that the requirements placed on subordinate units for the utilization of their transportation in effecting resupply are not excessive. On the other hand, the vehicles of the division quartermaster unit constitute the division reserve of vehicles, which is inadequate to meet in full the requirements for resupply of the division during a protracted period.

b. Class I supply.—An important duty of the quartermaster company is the distribution of class I supplies. These supplies consist of rations for men and animals, and other supplies consumed at a uniform daily rate. In order to relieve the combat troops of anxiety and to insure an uninterrupted flow of class I supplies, the delivery of these items is usually on an automatic basis. Their delivery should never be suspended unless the situation clearly demands it, and then only upon the order of the division commander.

c. Daily telegram.—Ration requirements are based upon the strength of the division in men and animals; gasoline and oil needs are based upon consumption rates. The strength reports of regiments and similar units are consol-

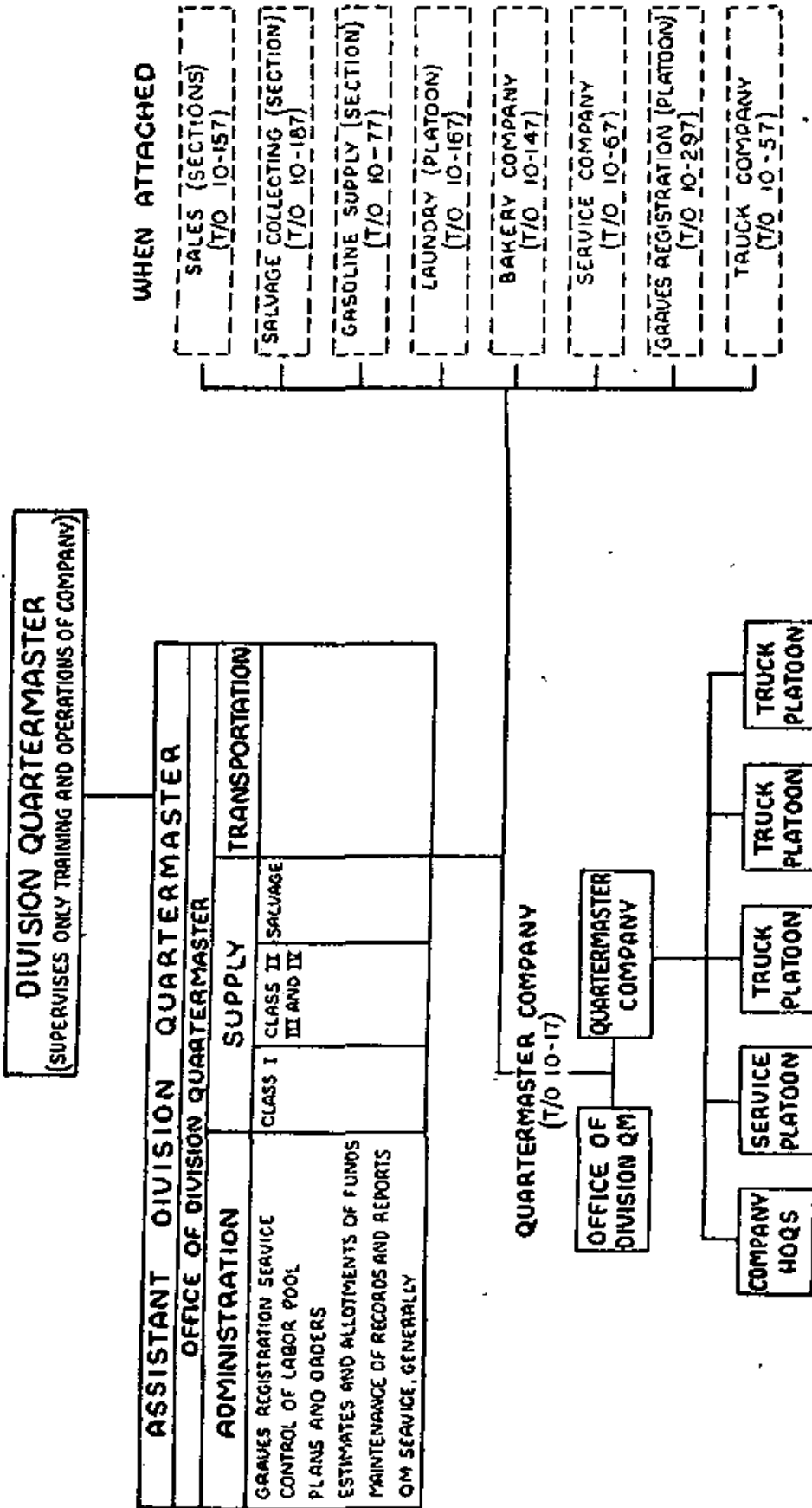

FIGURE 3.—Quartermaster service infantry division (T/O 10-17).

idated by the division adjutant who forwards the information to the division quartermaster. The unit supply officers report to the quartermaster the amount of gasoline and oil consumed in the preceding 24 hours. Based upon these figures, the quartermaster supply officer prepares the daily telegram, which is dispatched by the division quartermaster to the army quartermaster, a copy being furnished to the division G-4; for example, "Strength 12,960; animals 450; gasoline 26,300; oil 700. Div. QM 3d Division railhead." It is preferable to send the daily "telegram" by telegraph, but it may be a telephone message or a report delivered by messenger. The army quartermaster consolidates the telegrams from all units of the army, and transmits the division requirements to the regulating officer. He calls upon the communications zone depots for the supplies which are then dispatched on the daily train to the division area.

d. Daily train.—One unit section of the daily train carries the supplies for one division or similar unit. Each daily train consists of one to three unit sections, each unit section being left for unloading at its respective railhead. (See FM 10-10.)

e. Class I supply railhead.—(1) The class I supply railhead is a point on a railroad which provides rail accommodations for the supply of troops it is designated to serve. Class I railheads or truckheads will be established in practically every tactical situation. Generally not more than two divisions, or one division and corps troops, should be served from one railhead. The railhead should be in a location convenient to the troops it serves, but beyond the maximum effective range of hostile artillery and in an area protected from mechanized attack. It should have sufficient siding capacity to take care of the cars arriving at that railhead, together with adequate switching facilities; closed and open storage for supplies received; and sufficient space for sorting. A good road net, providing adequate turn-around facilities, is a prime requisite. Adequate office space together with shelter for the men should be provided and, if a reserve is to be kept at the railhead, sufficient storage facilities must be provided.

(2) The railhead is an agency of the regulating officer and is operated by a railhead platoon or company. The platoon or company commander is the railhead officer. As soon as he arrives at the railhead, he formulates his plan of operation, completes the necessary preliminary arrangements, then opens the railhead for operations. The time of opening is usually in advance of the arrival of the daily train, and during this time the railhead is ready to make issues from the railhead reserve (if there is one), to receive prisoners of war, soldiers on furlough, and salvage.

(3) When the field forces are operating in the presence of the enemy, the daily train should arrive at the railhead during the hours of darkness, preferably before midnight, in order to permit distribution before daylight. However, if the situation warrants, it may arrive during daylight. In other zones, it may arrive at any time the situation permits.

f. Class I railhead reserves.—A class I railhead reserve consists of items of class I supplies held in reserve at the railhead. In stabilized situations, a railhead reserve will usually be maintained. In mobile situations, the tactical situation, type of combat, facilities available, the terrain, and the danger of interruption of the lines of communication will influence the commander's decision as to the type and quantity of reserves. Whether a railhead reserve is to be maintained, and what the level of the reserve should be, is determined by the commander of the division or higher unit. In some situations, this reserve may be kept mobile on railroad cars. Overages due to time-lag between the sending of the daily telegram and the arrival of the daily train are placed in the railhead reserve, while shortages may be made up from this source. (See FM 100-10 and 10-10.)

g. Receipt by railhead officer.—Prior to the arrival of the daily train, the quartermaster supply officer secures the strength report for that day from the unit supply officers. The method of distribution to the troops having been determined, the quartermaster notifies the railhead officer of the number of rations required by each unit for that day and the method of distribution.

h. Distribution by the quartermaster.—(1) The method of distribution of class I supplies will be prescribed by the

division commander. There are three methods of distribution by the quartermaster to the troops: unit, railhead, and distribution to division distributing points or dumps.

(a) *Unit distribution.*—Unit distribution is that method by which the quartermaster distributes supplies to various elements of the division at the unit distributing point or kitchen area of each regiment or separate unit. Each unit supply officer furnishes the labor required for unloading trucks. The groups of quartermaster trucks necessary to transport the supplies for each unit are loaded at the railhead by labor furnished by the division quartermaster. Each group proceeds independently of other truck groups to the proper unit area. When there is danger of attack, the groups may be combined into a convoy. A detailed schedule for the operation of the quartermaster trucks should be incorporated in the quartermaster field order. Whenever unit distribution is contemplated, class I control points should be established where unit guides meet the quartermaster trucks, or regiments should send guides to the railhead. A class I control point is located at or near a well-defined terrain feature on the route between the railhead and the unit distributing point. The guides from the unit being served meet the quartermaster trucks here and guide them to the unit area of distribution. These class I control points should be designated in the administrative order of the division. Unit distribution is used when ample quartermaster transport is available, when time and space will permit, and when regimental transportation is not available.

(b) *Railhead distribution.*—In railhead distribution, regimental trucks of the various units draw their supplies at the railhead. They operate under quartermaster control while at the railhead. This method of distribution is used when the quartermaster transport is required elsewhere, when time is not a major consideration, when unit trains are within convenient operating distance of the railhead and when only one division is served at a railhead. Railhead distribution requires coordination between the quartermaster and the units being served. It is therefore vital that a schedule specifying the time when units come to the railhead appears in the division administrative order.

(c) *Division distributing points.*—(1) The division quartermaster may deliver class I supplies to each division distributing point or dump. This method may be used in certain retrograde movements where it is desirable to dump class I supplies at distributing points or dumps so that the unit kitchens may pick them up while moving toward the rear. It may be used when the distance or time involved is too great for either the quartermaster trains or unit trucks to make return trips during the allotted time. It may also be used where there is danger of an air attack and rapid dispersion of supplies becomes imperative. This method of distribution may be partial, some units having railhead or unit distribution while others are receiving their supplies at division distributing points or dumps. In either case, location of distributing points or dumps and time schedules for arrival of units thereat should be announced.

(2) In all methods of distribution, the vehicles traveling the greatest distance should be loaded first, except that in railhead distribution those vehicles bivouacked close to the railhead may be loaded first pending the arrival of the vehicles having a greater distance to travel.

(3) Due to circumstances beyond the control of the division quartermaster, it may be necessary to devise special methods of distribution or combinations of the methods described. These, however, should be held to a minimum. (See FM 100-10.)

i. Division reserve.—The quantity and type of rations to be carried in the quartermaster and kitchen trains will be announced from time to time by the division or higher commander. Probability of and type of combat, distance to army supply points, amount and type of transportation available, character and condition of road net, danger of interruption of lines of communication by hostile air and mechanized attack, terrain (defiles, etc.), and the probable relative urgency of need for class I supplies versus other supplies, will all influence the commander in making his decision as to quantity and types to be carried.

(1) Each kitchen will usually carry one "A" or "B" ration. As a general rule, the ration cycle will begin at supper. Rations delivered to the kitchens one night are for consumption

beginning with supper the next day. In special circumstances the cycle may begin with breakfast and the ration delivered one day will be for consumption beginning with breakfast the next day.

(2) Any ration prescribed by proper authority to be carried in the prescribed load of the quartermaster company will remain intact until such time as it is necessary to issue it, authority for its use being secured from the division commander. The supplies carried in the quartermaster company may be issued prior to the arrival of the daily train, provided the supplies arriving on the daily train are of the same type as those carried in the quartermaster train and the division commander has approved the issue. If this is done, the ration must be replaced in the quartermaster company as soon as practicable.

(3) The "A" ration may be issued daily from army class I railheads to all divisions and other units not actively engaged with the enemy. When the "A" ration arrives on the daily train, every effort should be made to issue it directly to the troops immediately upon receipt at the railheads. For this reason, whenever the "A" ration is received by the division, distribution of the ration carried in the quartermaster company or in the railhead reserve should be avoided.

j. Truckhead or navigationhead.—Supplies arriving at a truckhead or navigationhead will be distributed in a manner similar to that employed by the railhead. (Truckheads, navigationheads, and railheads are army supply points.)

k. Kitchens.—The meals are prepared at the bivouacs of the kitchens, grouped by regiments (or battalions). Immediately after dark, trucks are dispatched to locations from which the food can be carried to the line of contact.

l. Class I supply in varying situations.—(1) *On the march.*—When troops are on the march, distribution may be made to the new kitchen bivouacs after arrival thereat, or to the old kitchen bivouacs prior to the departure of the trucks.

(2) *Envelopment.*—In an envelopment, special attention must be given to the supply of the enveloping force and it may be necessary to attach some quartermaster trucks loaded with class I supplies to this force.

(3) *Attack*.—In the attack, the railhead and other quartermaster installations will probably be located relatively close to the combat area.

(4) *Pursuit*.—Special attention should be paid the encircling force, attaching to it the trucks loaded with class I supplies.

(5) *Defense*.—In the defense, the railhead and quartermaster installations will probably be located well to the rear.

m. Gasoline and oil supply.—(1) The army quartermaster will establish gasoline and oil supply points at railheads and depots, or at other convenient locations on the main supply routes, such as civilian gasoline filling stations, or mobile filling stations.

(2) So far as practicable, an initial distribution of gasoline in containers will be made to each motor vehicle.

(3) Vehicles sent to any army supply point will replenish their supply of gasoline and oil at the army supply point or at a convenient filling station en route to or from the army supply point.

(4) Vehicles remaining in the forward area (such as weapon carriers or prime movers) will be resupplied by exchanging empty containers for full ones brought forward from gasoline and oil supply points by regimental or divisional transportation. Distributing points may be established in the forward area in order to facilitate the supply of these vehicles. The location and time of operation of the division gasoline and oil distributing points should be included in the division administrative order.

(5) Drivers of vehicles will receipt for gasoline and oil received at filling stations and distributing points.

n. Class II and IV supplies.—Class II and IV supplies (except animals) are secured by the troops through the medium of requisition based upon the needs or estimated requirements of their organization. Unit supply officers submit periodic requisitions to the division quartermaster. These requisitions, when approved by the division commander, are forwarded by the division quartermaster to the army quartermaster. Requisitions are forwarded by army to communications zone (class II), and to theater headquarters (class IV) a copy being furnished the regulating officer. When ap-

proved, the army quartermaster makes the supplies available to the division in army depots. When there is sufficient motor transportation available in the division, the division quartermaster will draw the supplies from the army depots filling the requisitions. If there is insufficient division transportation available, the division quartermaster may request that the supplies be shipped on the daily train or by army motor transport to the division area. Upon receipt of the supplies, the quartermaster makes distribution to the units. Credits may be set up by a higher unit for subordinate units in various depots and may then be drawn by the division quartermaster or unit supply officer. This eliminates the formality of requisition and expedites delivery of these supplies to the troops.

o. Animal replacements.—Requisitions for animals are submitted by the division quartermaster in the same manner as for other class II and IV supplies. Animals are issued from army remount depots, but if sufficient animals are not available, the requisition is extracted to the communications zone remount depots. They are either shipped by rail or motor, or marched overland to the division area. When received there, they are delivered to the units in accordance with priorities established by the division commander.

p. Water.—(1) Each kitchen carries as a part of its normal load a limited supply of water for drinking and cooking. Resupply is effected either locally or by sending empty containers in unit or quartermaster regiment transportation to division supply points. These supply points are established by the division engineers when approved local supplies are not conveniently accessible to the kitchens.

(2) If 5-gallon containers are used, these are delivered to the unit supply officers in return for empty containers. These empty containers are then returned to the water supply points and refilled. If local resources are insufficient, army engineers will establish water supply points, using either tank trucks or railroad tank cars.

q. Employment of transport.—The truck platoons, under their respective platoon commanders, operate in accordance with orders issued by the division quartermaster. The types of motor vehicles with which the motor platoons are equipped

are designed for use over unimproved as well as improved roads. The truck platoons move supplies, transport troops, and such division reserve of class I supplies, small arms and field artillery ammunition as may be prescribed by the division commander. They also supplement ammunition carrying vehicles of units within the division. These platoons form the nucleus for the division motor pool. The quartermaster supply officer and unit supply officers cooperate closely in effecting economy of transportation in the distribution of all supplies.

r. Bivouacs.—(1) Owing to the danger of hostile air attacks, the various activities of the quartermaster company are dispersed. With present day communication and transportation, the division quartermaster and his staff can perform their duties and make such inspections as are necessary without having the division quartermaster office and company command post in close proximity to all elements of the company. The division quartermaster's office may be located in or near the rear echelon of division headquarters. The company headquarters is bivouacked in the general vicinity of the division quartermaster's office, and the service platoon is usually bivouacked near the railhead. The truck units may be located either near the railhead or the ammunition supply point. If these installations are widely separated, it may be advisable to bivouac one unit near each installation. Truck units are bivouacked so as to conceal their vehicles from air observation. This concealment can be secured by placing the trucks in garages of the cities and towns in which the units are bivouacked, or along city streets with a considerable number of shade trees, or they may be parked along country roads under trees supplemented by camouflage. Vehicles also may be bivouacked in or near edges of woods or patches of trees, and every effort is made to secure within each group of trucks as great a dispersion as possible. When placing vehicles under trees, every effort is made to conceal the vehicle not only from overhead observation and photography, but from oblique aerial observation and photography as well.

(2) Further protection may be had by the proper use of camouflage such as nets, branches of trees, and brush. By

changing the pattern to resemble other objects compatible with the surroundings, additional concealment can be secured. (See FM 5-20.)

(3) Tracks made through fields and in mud and snow by personnel and vehicles can be easily detected in aerial photographs. Therefore, the movement of personnel and vehicles should be so restricted as not to disclose the presence of camouflaged bivouacs unnecessarily.

s. Graves registration.—(1) In stabilized situations, graves registration and mortuary matters are functions of the division quartermaster. The graves registration section of the division quartermaster's office is responsible for the location of cemeteries and the registration of graves. This section is responsible for preparing sketches showing permanent landmarks, and for compiling data necessary to locate the cemeteries. It is responsible for identification and proper burial, and for keeping the number of single graves to a minimum. The inspection, collection, and disposition of personal effects of the dead are performed under supervision of this section. This section is also responsible for general supervision of all attached graves registration units. Their primary function is to perform clerical and supervisory work. The labor in connection with burial is performed either by labor from the service companies of quartermaster units or by troops. In a rapidly moving situation a "team" composed of graves registration troops, labor units, medical service, and truck units, formed by Army or GHQ to follow up and do this work, may be located at each of the collecting stations and at the division clearing stations; that is, at points where the greatest number of dead are to be found. The graves registration unit, assisted by a detachment from this team, makes a systematic search throughout the battlefield with particular attention to the unit first-aid stations. The transportation necessary for burial may be furnished by the motor units of the Quartermaster Corps.

(2) Cemeteries are located, if possible, near the expected bulk of casualties. If desirable sites are available, they are used to favor the main attack. Cemeteries are located, if possible, where the soil is well-drained and easy to dig. It

is preferable to establish them in existing local cemeteries or near churches. Where possible, they are concealed from hostile observation and protected from hostile artillery fire. (See FM 100-10.)

t. Protection.—The protection of the quartermaster train is a responsibility of the company commander. The company itself is equipped with rifles and automatic pistols and, if the situation warrants, the battalion commander should supplement these with a request for additional protection. The best protection of the motor trucks is their speed. Additional protection can be furnished by concealment and dispersion and the establishment of road blocks.

u. Ammunition.—Whenever unit trains must be assisted in hauling ammunition, the necessary quartermaster transportation is attached to the units for definite periods. When a division ammunition dump is to be established, the necessary quartermaster transportation is turned over to the division ordnance officer for this purpose.

v. Traffic and traffic control.—All personnel of the quartermaster company must thoroughly understand all regulations and orders for the control of traffic, including location of the light line or other restrictions concerning use of lights that may be imposed upon service and other elements of the division. It must be familiar with the direction of traffic on all roads and the operation of traffic control signals and officers' control stations. (See FM 25-10.) Normally, when on the march, the division quartermaster train marches under division control. Whenever it is necessary to operate the company to serve the division, the quartermaster should secure from G-4 authority for the release of as much of the organization as he needs.

w. Plans and orders.—(1) The division commander and his staff collect information and make an estimate of the supply situation. In making this estimate, they consider the effect that changes in the tactical situation will have upon the plan of supply. They consider the effect of weather, the location and character of bridges and defiles, and the effect that their destruction will have. They study the road net as well as the railroad net, and prepare to revise the plan of supply as required. Based upon the estimate of the supply

situation, the division quartermaster makes his plans to include—

- (a) Recommendation of railhead sites.
- (b) Location of all quartermaster establishments.
- (c) Employment of all quartermaster units.
- (d) Arrangements necessary for supply.
- (e) Replacement of animals.
- (f) Burial.
- (g) Bivouacs of kitchen trains of all units of the division.
- (h) Bivouacs and command posts of all quartermaster units.

(2) As soon as the plan is prepared, fragmentary orders are issued to put the plan into action. For record purposes and to insure proper understanding by the quartermaster company, fragmentary orders issued, together with other essential arrangements of the plan, may be repeated in a written field order or in an annex where applicable. (See FM 101-5.)

x. Reports.—The division quartermaster is also responsible for reports. A journal is maintained within the quartermaster company which contains all important instructions received or issued, together with the source and name of the person giving them; a résumé of all written and oral messages; and any situation or circulation maps which may have been published. Another requirement is a daily report which includes the strength of the company, the number of casualties, the number of stragglers, location of the quartermaster units and installations, a statement covering the supply and evacuation situation, and any other quartermaster activities. For staff records, maps, and reports, see FM 101-5.

SECTION III

CAVALRY DIVISION (HORSE)

■ 74. GENERAL.—*a.* The quartermaster service in the cavalry division provides the necessary personnel and units, organized into a quartermaster squadron, for quartermaster administration, supply transportation, and quartermaster special staff service within the cavalry division. The quartermaster squadron consists of squadron headquarters,

and headquarters troop, two troops (truck), one troop (pack), and attached medical. (See fig. 4.)

b. These elements of the quartermaster squadron, except the troop (pack), function in a manner similar to that of corresponding units of the quartermaster company, infantry division. The troop (pack) includes four platoons of 50 pack mules each. They are available for cargo purposes but are loaded only when necessary, for example, when combat is imminent or when supplies must be transported over terrain impracticable for motors. Each pack mule is able to carry a maximum pay load of 200 pounds.

■ 75. QUARTERMASTER OPERATIONS.—a. The general procedure governing quartermaster operations in the infantry division apply to the cavalry division and should be employed whenever practicable. Modifications, however, frequently are necessary. The wide fronts over which cavalry may operate, its probable distance from suitable rail facilities, and the difficulty of dispatching and guarding convoys may necessitate intermittent supply at 2- or 3-day intervals, in which case cavalry subsists on its reserve supplies, if available, or resorts to local procurement. When intermittent supply is necessary, replacement for the interval missed should be automatic unless otherwise recommended by the cavalry division. Often, owing to the lack of rail facilities accessible to motor elements of the quartermaster squadron, it will be necessary for the army to forward supplies by motor transport to truckheads which can serve the cavalry division. An alternative method is to attach to the division the trucks from the motor transport service which are loaded with essential supplies. These trucks may dump their initial loads, the dumps so established becoming supply points for the division or regiments. The motor transport trucks then haul between the army supply points and the dumps. It may be necessary to utilize the air transport service to carry essential supplies to certain units when extreme distance from the base or the presence of hostile troops precludes the use of motor transport.

b. Cavalry frequently may be directed to supply itself by purchase or requisition with certain items from the resources

of the country in which it is operating. The division quartermaster must exert every effort to accomplish the collection and distribution of such supplies without interfering with or delaying the tactical mission of the combat troops. Before entering a territory in which the command may be required to live off the country, the division quartermaster should obtain all available information concerning its resources. Upon entering the territory, systematic inspections of all parts of the locality should be made to verify previous reports and to gain additional information. Plans and preparations should be made for the collection and distribution of supplies to be purchased or requisitioned. Organizations, except in emergency or when especially authorized to do so, should not be permitted to seize supplies for their own use. When practicable, all supplies should be collected at specific points where they are taken over by the quartermaster and issued to the command in the usual manner. To simplify the exploitation of resources of a territory, full use should be made of local authorities. These authorities ordinarily know the amount of supplies available within their communities and the quantities that can be procured. In friendly territory, local transportation and labor may be hired. In hostile territory, they may be hired or impressed. In either case, local transportation and labor will be more difficult to handle than military, and should be employed only when necessary. Their most frequent use will be in the collection of supplies to convenient points where such supplies can be picked up by organic transport.

c. Gasoline and oil requirements increase the difficulty of completely supplying a cavalry division from local resources, especially in hostile territory. These commodities are easily destroyed. In friendly territory, procurement in sufficient quantities will be dependent upon the locality.

d. An adequate supply of forage is equally as important to cavalry as a full supply of rations. Horses quickly become unserviceable if deprived of adequate forage. There is insufficient transportation in the cavalry division to carry hay in addition to other loads. If hay is not otherwise available, the division quartermaster must be constantly on the lookout for some suitable substitute. Other grasses and nearly all

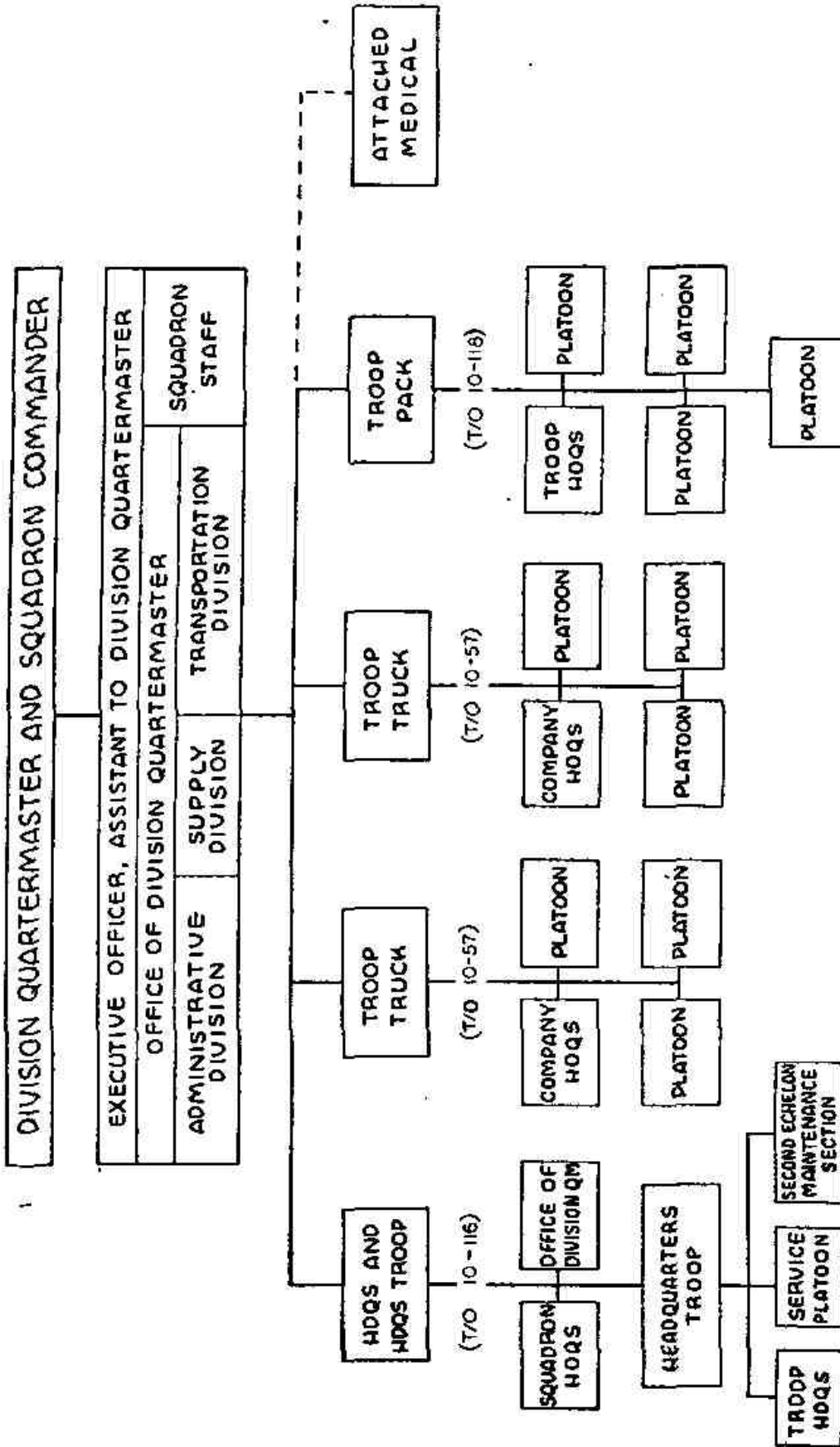

FIGURE 4.—Organization of quartermaster squadron, cavalry division (horse) (T/O 10-115).

growing crops may help to take the place of hay. Frequently substitutes for oats, such as corn, barley, wheat, rye, peas, beans, rice, or similar grains must be found. When procuring substitute forage, the quartermaster should consult the veterinarian to be sure that the contemplated forage will not be injurious to the animals for which it is procured.

e. Cavalry often must operate in a theater where the large requirements of water for its men, animals, and motors cannot be obtained locally. When sufficient water is not available in the area in which cavalry is operating, it may have to be brought in by rail, motor transport, or pipe line, and distributed to units at water distributing points. At these points, water sometimes is distributed to unit kitchen trucks by exchange of full 5-gallon containers for empties.

f. If local resources in gasoline, oil, forage, and water are not readily available, the amount of transportation to bring up these supplies from the rear is a large factor in determining the quantity of reinforcing transportation that must be made available both to the regiments and to the division as a whole.

g. In rapidly moving situations, there will be little opportunity to procure quartermaster class II, III, and IV supplies and remounts from the rear. In such cases, when the replenishment of these supplies or the replacement of remounts is urgent, the division quartermaster must resort to local procurement. Whenever class I supplies are shipped to the cavalry division through a railhead, it may be practicable to periodically attach additional cars of other quartermaster supplies including horseshoes, clothing, saddle equipment, and other urgently needed replenishments to the daily train. Ammunition, ordnance, and engineer supplies also may be shipped to the cavalry division railhead when conditions permit and when the cavalry is operating at considerable distances from the army depots. (See FM 10-10.)

SECTION IV

ARMORED DIVISION

■ 76. GENERAL.—Quartermaster service in the armored division is provided by the quartermaster section of the rear

echelon of division headquarters, and by the division quartermaster platoon, and the service platoon of headquarters company of the supply battalion (T/O 10-35).

■ 77. ORGANIZATION.—The supply battalion consists of a headquarters and headquarters company (T/O 10-36), two truck companies (T/O 10-37), and attached medical. The battalion headquarters is the administrative unit which controls operation of the battalion. The headquarters company is the general service unit of the battalion; it furnishes second echelon maintenance and provides for routine administration and messing of the battalion headquarters, the division quartermaster platoon, the service platoon, and the division ammunition section. The truck companies provide means for transporting the organic load carried by the supply battalion. The medical detachment provides medical service for the battalion.

a. Battalion headquarters.—Battalion headquarters consists of a headquarters section and a personnel section.

b. Headquarters company.—Headquarters company consists of a company headquarters, a service platoon, division quartermaster platoon, and a division ammunition section (attached ordnance).

(1) Company headquarters consists of—

(a) Command section.

(b) Maintenance section, which provides second echelon maintenance for the entire battalion.

(c) Administrative, supply, and mess section.

(2) The service platoon provides the labor to the division quartermaster for division ration and supply break-down, and labor for the division ordnance officer for handling the ammunition load of the supply battalion in its distribution within the division. While performing these functions, the personnel of this platoon are directly under the control of the division special staff officers concerned.

(3) The division quartermaster platoon consists of four sections: subsistence, transportation, fuel and lubrication, and supply. This platoon functions under control of the quartermaster but is administered, rationed, and trained in basic military subjects by the supply battalion commander,

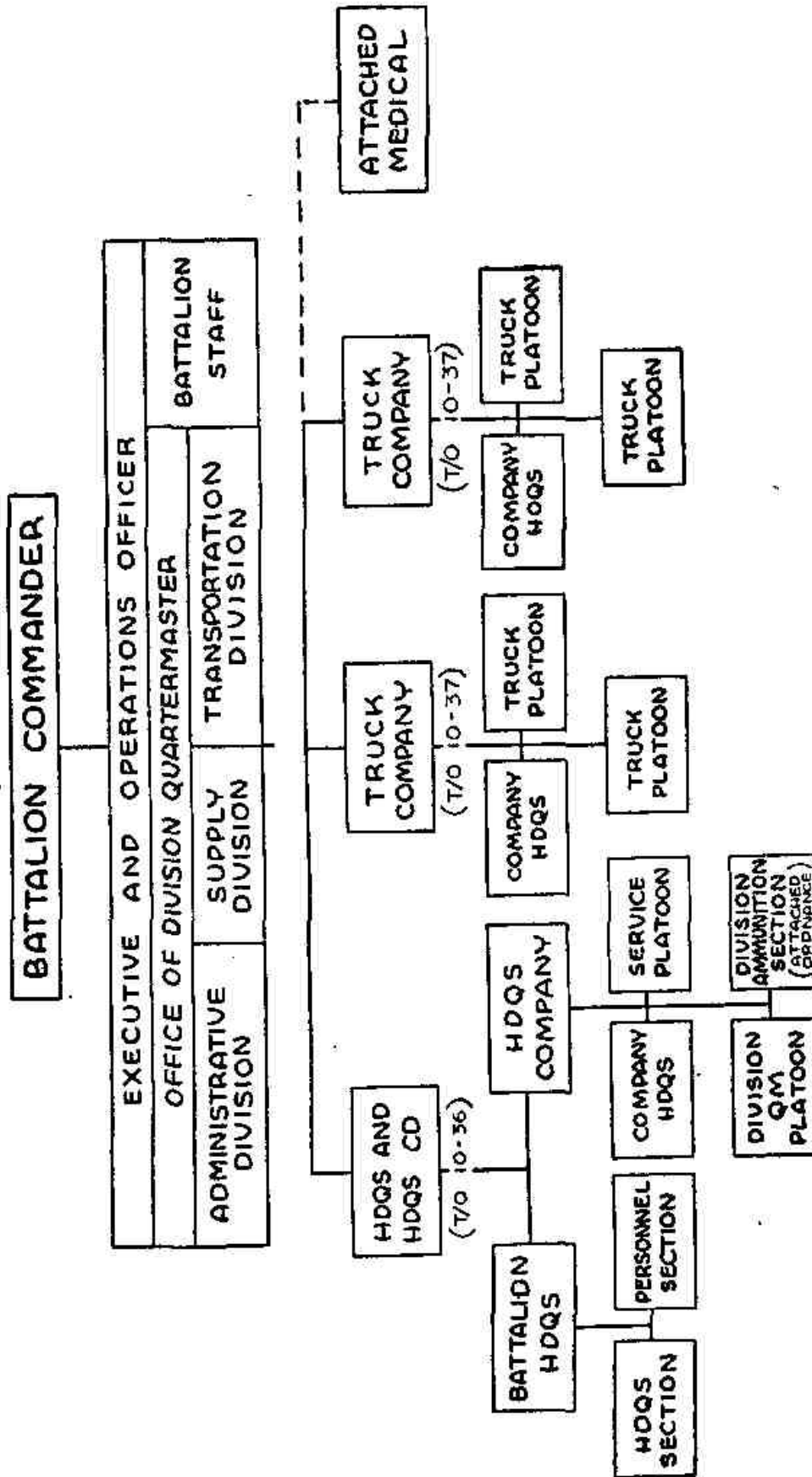

FIGURE 5.—Organization of supply battalion, armored division (T/O 10-35).

as directed by the division commander. (See FM 17-50 and 17-57.)

(4) The division ammunition section operates the division ammunition control point under the direct control of the division ordnance officer. Its relationship to the supply battalion is similar to that of the division quartermaster platoon.

(5) In the field, the personnel of the division quartermaster platoon, service platoon, and division ammunition section should be attached for rations to a unit nearest to the point where they can best perform their supply functions.

c. Truck companies.—Each truck company is divided into a company headquarters and two truck platoons. Each company is provided with 51 trucks (2½-ton) and 51 1-ton, 2-wheel trailers. Forty-eight of each of these trucks and trailers are available for transportation of class V supplies. The total cargo capacity of each truck company is 168 tons.

■ 78. OFFICE OF DIVISION QUARTERMASTER.—A normal organization of this office will be to divide it into an administrative, a supply, and a transportation division. The division quartermaster is only a staff officer on the division commander's special staff. He does not have command functions.

■ 79. OPERATIONS.—*a.* The absolute dependence of the armored division on adequate and timely supplies, particularly gasoline and lubricants, creates a supply problem which the quartermaster must be prepared to meet and solve. The distances covered by the armored division and the speed of its operations will necessitate advance planning by the quartermaster. The supply problems must be analyzed and solved before the tactical problems. The sustained mobility of armored units is dependent upon adequate and timely replenishment of supplies. This will often require elaborate measures for deception and surprise. It may often be necessary to have advance stockage of supplies concealed in areas where they may be readily obtained. Thus, the supply system must be flexible.

b. Class I supply.—Minimum reserves of class I supplies will be carried on the vehicles and in the trains of the division. The supply of armored units is based on the rule that

all units will carry enough class I supplies for 3 days' operation. Railhead or other army supply point distribution is normal. There is no truck transportation available to the division quartermaster for making unit distribution. The supply officer of the major combat unit in the combat command is responsible for drawing supplies for all units attached to the combat command.

c. Class III supply.—Minimum reserves of class III supplies will be carried on the vehicles and in the trains of the division. The method of distribution of gasoline and lubricants will be similar to that provided for class I supplies. There is no transportation available to the division quartermaster for making unit distribution. It is the direct responsibility of the division quartermaster that the army, corps, or other higher echelon place the required amount and kinds of class III supplies within convenient distance of the troops. This service by the higher echelon must include the reducing of bulk gasoline to 5-gallon cans and loading them upon the unit vehicles. A 2 days' supply of fuel (including the amount carried in the vehicle tanks) will be carried within the regiments and separate units. A day of operation is considered as 100 miles of movement for all vehicles.

d. Class II and Class IV supply.—The supply of these classes is normally accomplished during lulls in operations.

e. Class V supply.—The system of supply of ammunition is similar to that in other divisions. The primary function of the trucks and trailers furnished by the quartermaster truck companies is the transportation of ammunition, and only in exceptional cases will these trucks and trailers be used for the transportation of supplies other than those of class V.

SECTION V

MOUNTAIN DIVISION

■ 80. GENERAL.—Quartermaster service in the mountain division is provided by a quartermaster battalion (T/O 10-335). The quartermaster services in the mountain division are similar to those in the infantry division, with such modifica-

tions as are necessary to meet the needs peculiar to the mountain division. Mountainous roads, high altitudes, changeable weather conditions, difficulties of supply and communication, and the unusual wear upon quartermaster equipment and motor vehicles will develop special problems which the quartermaster must be prepared to overcome. Rail or truckhead distribution of supplies will generally be employed. Adequate preparation must be made for contingencies which will arise. Personnel must be thoroughly trained for their particular duties and must be familiar with traveling conditions in mountainous areas.

■ 81. ORGANIZATION.—The quartermaster battalion consists of a headquarters and headquarters company (T/O 10-336), two truck companies (T/O 10-57), four pack troops (T/O 10-118), and attached medical.

a. Office of division quartermaster.—This office has in it the battalion commander, the division quartermaster; the executive officer, second in command of the battalion and assistant division quartermaster; the division supply officer and the assistant division supply officer. This office will normally be divided into an administrative, supply, and transportation division similar to that in the infantry division. It is organized to facilitate the direction, administration, and operation of quartermaster activities for the division.

b. Battalion headquarters.—Battalion headquarters performs the normal functions of a battalion headquarters.

c. Headquarters company.—Headquarters company consists of a company headquarters, service platoon, and a second echelon maintenance section. Company headquarters performs the normal functions of a company headquarters. It has in it the company commander, and the second in command of the company, who is the company and battalion motor maintenance officer. The service platoon furnishes the necessary labor to handle supplies and is the nucleus for the division labor pool. The second echelon maintenance section performs second echelon motor maintenance for the battalion.

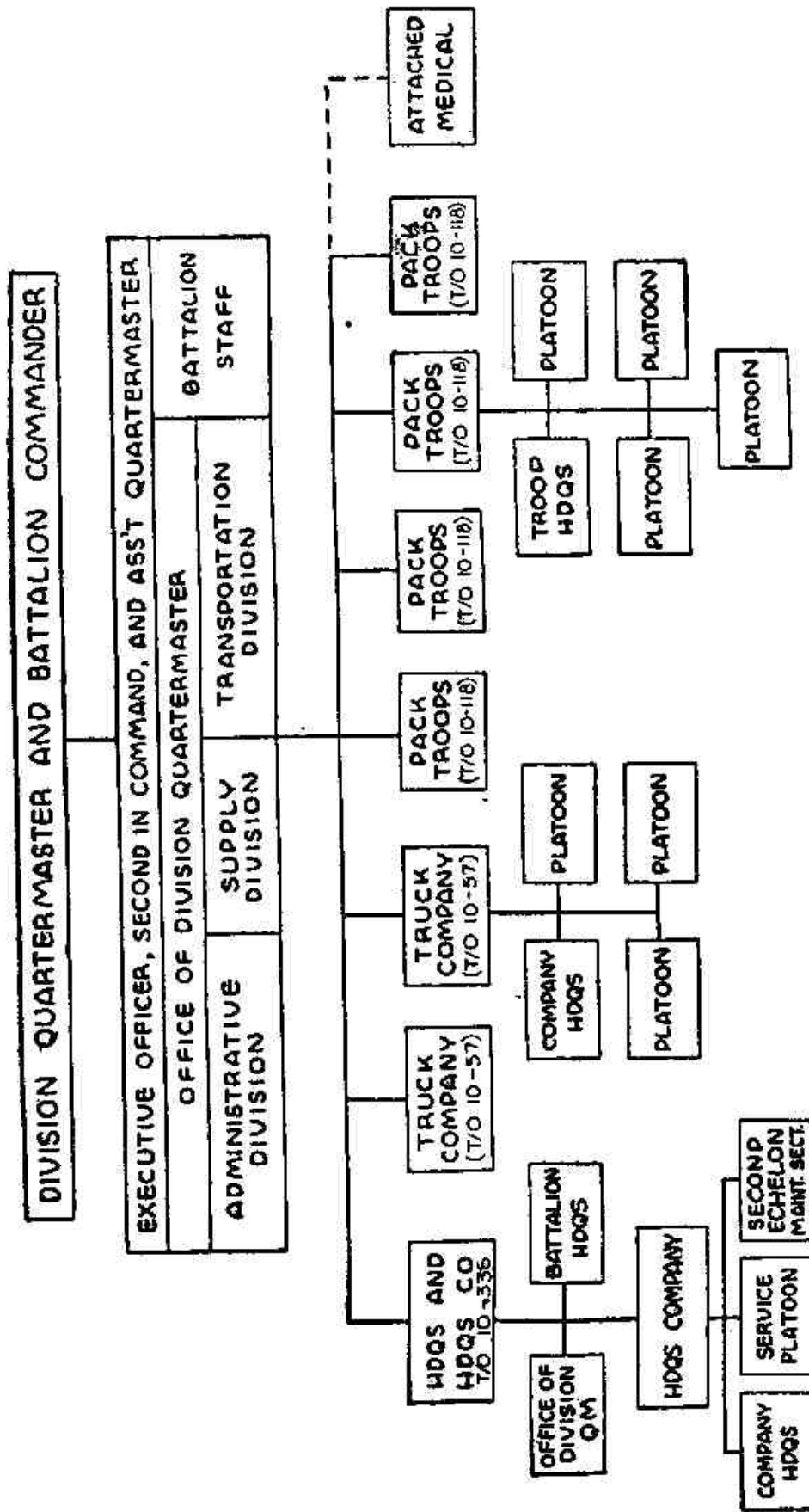

FIGURE 6.—Organization of quartermaster battalion, mountain division (T/O 10-335).

SECTION VI

MOTORIZED DIVISION

■ 82. ORGANIZATION.—Quartermaster service in the motorized division is provided by a quartermaster battalion (T/O 10-315). The battalion consists of headquarters and headquarters company (T/O 10-316), one truck company (T/O 10-57), one gasoline supply company (T/O 10-77), and attached medical.

a. *Battalion commander.*—The battalion commander is a staff officer (the division quartermaster) on the special staff of the division commander. As commander of the battalion he performs the normal duties of a commanding officer. As division quartermaster he is responsible for the efficient operation of the quartermaster service of the division in accordance with the policies and decisions of the division commander.

b. *Division quartermaster office.*—This office is headed by a battalion commander who is the division quartermaster. The executive officer, who is second in command, is assistant division quartermaster. In this office also are the supply officer and the assistant supply officer. This office is organized to facilitate the direction, administration, and operation of quartermaster activities for the division. The organization in general will be similar to that provided for in the supply battalion of the armored division, with such variations or modifications as are necessary to meet the needs of the motorized division.

c. *Headquarters company.*—Headquarters company consists of company headquarters, service platoon, and a second echelon maintenance section.

■ 83. OPERATIONS.—Quartermaster operations in the motorized division are analogous to those in the armored divisions in many respects. The missions of motorized divisions, their special equipment, and their speed and mobility will develop special problems which the quartermaster must be prepared to meet and overcome. All classes of supplies, with the exception of ammunition, will be provided by the quartermaster battalion. One of the principal functions of the battalion will be to supply gasoline and oil to the division. The method

of distribution will be prescribed by the division commander. The location of railheads, truckheads, gasoline distributing points, or other establishments where replenishment of supplies is received is important. The supply system must be flexible enough to meet the changing demands of the divisions.

SECTION VII

THE CORPS

■ 84. GENERAL.—*a.* The corps, being primarily a tactical unit, has but a few administrative responsibilities. The corps is responsible for the allocation to divisions, as well as to corps troops, of such supplies and credits as may be allocated to it by higher authority.

b. The corps quartermaster service under the corps quartermaster consists of the office of corps quartermaster; two quartermaster companies, truck (T/O 10-57); one quartermaster company, gasoline supply (T/O 10-77); and one quartermaster company, service (T/O 10-67). It is designed primarily to meet two requirements:

(1) The quartermaster service of the corps troops.

(2) The special staff functions of the corps quartermaster.

c. When a corps is operating independently and is charged with primary responsibility for its own supply and evacuation, it will be necessary to attach to it additional service troops in order to operate establishments similar to those prescribed for the army. These attachments normally will be one company, service; two companies, truck; one company, gasoline supply; and one company, car.

■ 85. SPECIAL FUNCTIONS.—*a.* The office of the corps quartermaster is the headquarters of the corps quartermaster service and is located at or near the rear echelon of corps headquarters. This office supervises and directs all quartermaster activities pertaining to the corps. It is divided into three operating divisions: administrative, supply, and transportation, as shown in figure 7.

b. When the corps is part of an army, the corps quartermaster operates the following establishments: corps motor parks, corps dumps, and distributing points for corps troops.

■ 86. **SUPPLY.**—*a.* The corps is responsible for the service of corps troops. It is also responsible for the allocation to the divisions and corps troops of such supplies as may be allotted to it by the army in the form of credits.

b. The corps is concerned with the supply of its divisions only to the extent that the supply is satisfactory. The normal chain of supply, except for allocations of ammunition and at times other classes of supplies which are subject to

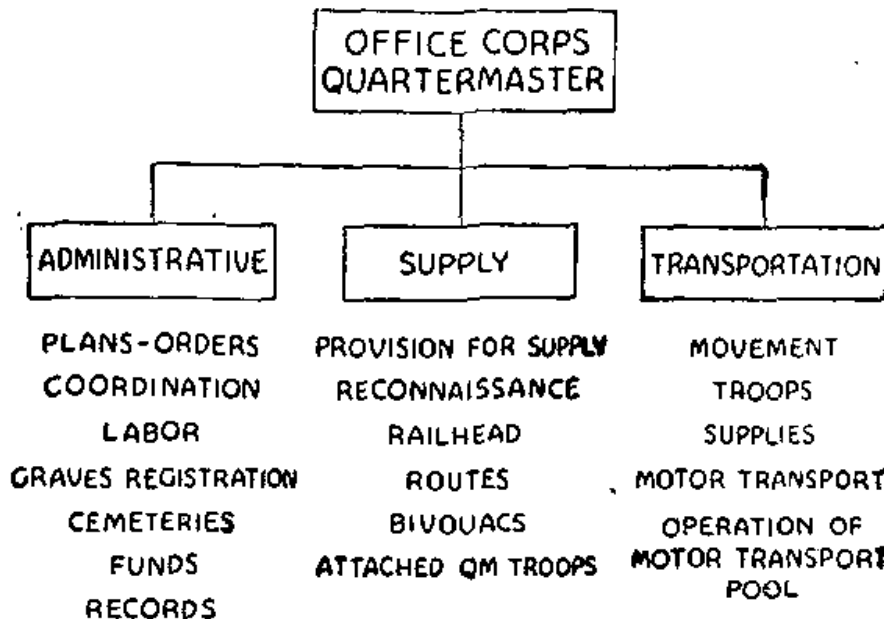

FIGURE 7.—Operating divisions, office of corps quartermaster.

allotment by corps to divisions, is direct between army and divisions. Animal replacements are supplied to divisions either through the corps or directly from the army remount depot. (See fig. 8.) (See also FM 100-10.)

■ 87. **TRANSPORTATION.**—*a.* The motor transport service, army corps, (excluding quartermaster section, corps headquarters) consists of two quartermaster companies, truck (T/O 10-57); and one quartermaster company, gasoline supply (T/O 10-77).

b. The independent corps, responsible for its own supply and functioning as a small army, requires the greatest of flexibility in the utilization of motor transportation. In open warfare, motor transportation may be used extensively in the maneuvering of divisions.

■ 88. **COMPARISON OF CORPS OF ANY ARMY AND INDEPENDENT CORPS.**—The difference in function and operation of the corps quartermaster service when the corps is part of a field army and when it is serving as an independent corps is illustrated in figures 9 and 10.

■ 89. **MISCELLANEOUS SERVICES.**—Miscellaneous services include mobile and portable establishments set up by attached units such as laundry companies, sterilization companies, and salvage collecting companies.

SECTION VIII

THE ARMY

■ 90. **FUNCTIONS.**—The quartermaster service in an army is charged in general with providing quartermaster service to the command as follows:

- a. Procurement and issue of all quartermaster supplies.
- b. Transportation of troops and supplies by motor and animal means.
- c. Operating labor service and motor pools.

■ 91. **ARMY QUARTERMASTER.**—The official designation of the officer responsible for quartermaster service is the army quartermaster, and his duties in general are—

a. *Staff.*—(1) Adviser to the commander and general staff on matters concerning quartermaster activities.

(2) Planning, including estimates of requirements in supplies, equipment, and personnel; recommendation of locations of railheads; locations of quartermaster establishments; employment of quartermaster units, supply arrangements; animal replacements; burials and bivouacs; exploiting local resources for supplies, motor and animal transportation, storage, and labor.

(3) Technical supervision and inspection, within the limits prescribed by his commander, of quartermaster activities in subordinate units.

(4) Examination of captured quartermaster equipment.

b. *Command.*—(1) Command of the quartermaster service of the field army.

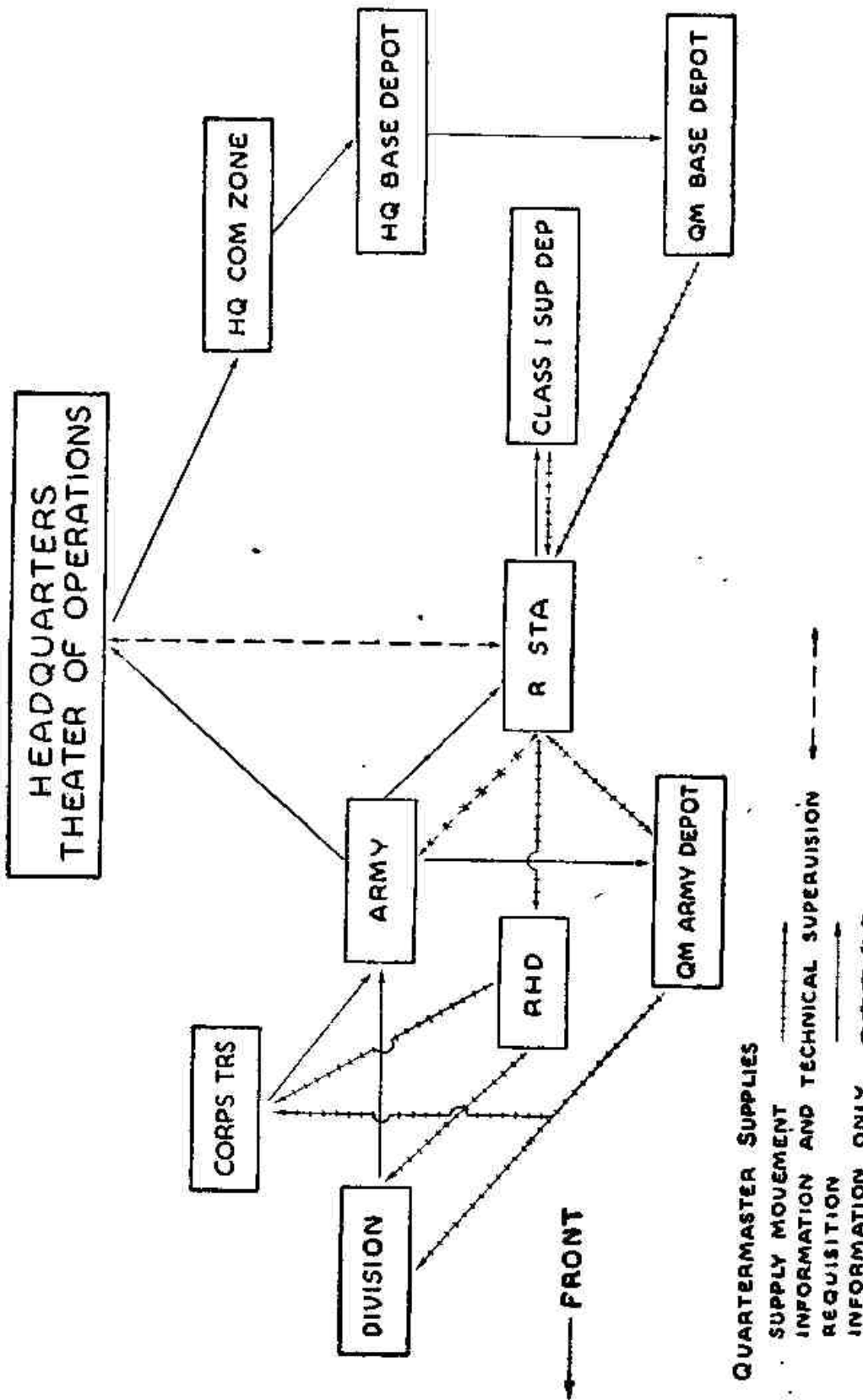
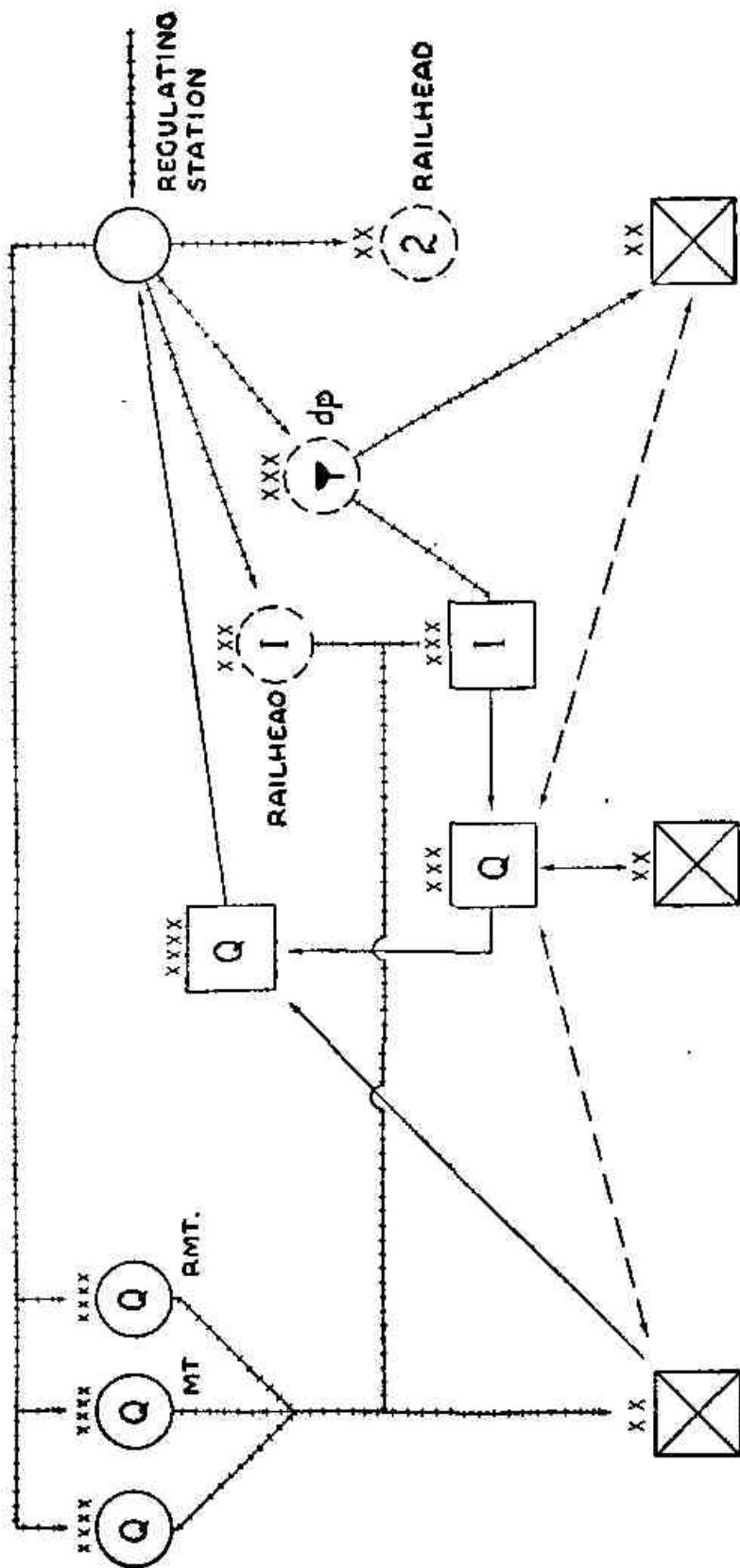

FIGURE 8.—Quartermaster service in the field of operations.



CORPS QUARTERMASTER SUPPLIES CORPS TROOPS ONLY

NOTE: REQUISITION

SUPPLY MOVEMENT

INFORMATION AND TECHNICAL SUPERVISION

Figure 9.—Corps quartermaster service as part of an army.

(2) The efficient operation of his service in accordance with policies, plans, and basic decisions of the army commander.

■ 92. ORGANIZATION.—The quartermaster service, field army, (excluding quartermaster section, army headquarters) consists of one quartermaster regiment, truck (T/O 10-51); one quartermaster battalion, gasoline supply (T/O 10-75); one quartermaster company, depot (supply) (T/O 10-227); one quartermaster company, car (T/O 10-87); six quartermaster battalions, service (T/O 10-65); and one quartermaster battalion, sterilization (T/O 10-175).

■ 93. ESTABLISHMENTS.—*a.* The army service area covers that territory between the rear boundaries of the corps and the rear boundary of the combat zone. Army quartermaster establishments and army quartermaster service troops are usually located in this area. The army in the combat zone is the basic supply unit. It is responsible for the timely supply of its component divisions, corps, and army troops. The corps, as a rule, has few supply responsibilities except for corps troops. The normal chain of quartermaster supply is direct between the army and the divisions. The army quartermaster assures flexibility of supply by maintenance of reserve stocks in quartermaster depots under his direct control. Army quartermaster depots are located on or are convenient to a railroad connecting with the communications zone where railroad siding facilities are adequate for the handling of supplies. The army quartermaster depot should be located beyond effective range of known enemy artillery, within practicable hauling distance of the trains of units to be supplied, and should have a good all-weather road net connecting units to be served. The locations of the army quartermaster depot is so selected and planned as to avoid frequent moves. Ordinarily it is not located in the vicinity of an ammunition depot. Depending on the military situation, the army may have quartermaster supply depots, field remount depots, sterilization establishments, salvage plants, laundries, bakeries, and sales companies. The army quartermaster maintains in his depots only such stocks that the

military situation demands be kept nearer the front than the depots of the **communications zone**. Decision as to the kinds and quantities of supplies to be maintained is a responsibility of command. Accumulations of excessive amounts of supplies in the combat zone should be avoided.

b. The army establishes gasoline and oil filling stations at supply points and on all main supply roads. These filling stations are operated by gasoline supply companies and battalions. A battle reserve of not less than one complete refill for all vehicles should be maintained in the area. There should also be kept as much more reserve as the plans for future operations may indicate as necessary. Expenditures are reported to the army in the daily telegram and are then checked against the report of issues from the various stations as a basis for the amount to be requisitioned.

■ **94. CAMOUFLAGE.**—*In general, camouflage work is executed by the troops of the activity or area being camouflaged. Major camouflage projects are executed by engineer troops. (See FM 5-20.)*

a. *Use.*—(1) Natural cover should be supplemented by camouflage, which, when successful, not only conceals the camouflaged objects but also disguises the fact that camouflage has been used. So far as practicable, the enemy must be kept in ignorance of any change in conditions, and work must be conducted so that it will not register in aerial photographs or be detected by enemy ground observers. Photographs frequently disclose things *not visible to an observer's unaided eye*. Organization commanders should, therefore, familiarize themselves with the basic considerations in camouflage; prevent the making of trails, tracks, or other betraying marks in the vicinity of any work; and instruct their personnel in the use of natural and artificial cover.

(2) Natural cover, or camouflage prepared from natural material, is usually more effective and economical than cover prepared from artificial material. Full advantage should always be taken of such cover. When natural material is used for camouflage, care should be taken to see that wilting does not destroy its effectiveness.

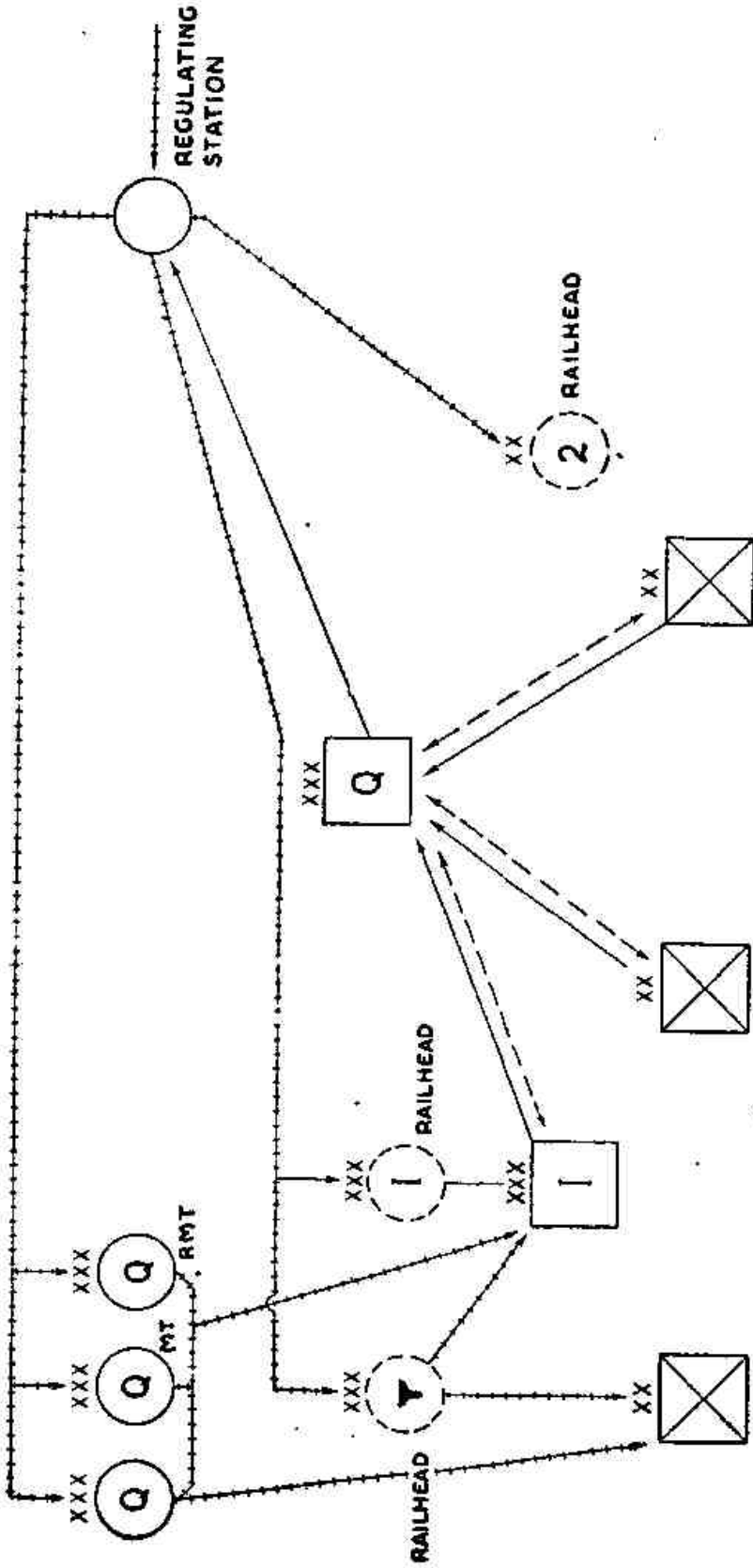

CORPS QUARTERMASTER SUPPLIES ALL TROOPS OF THE CORPS

NOTE: REQUISITION

SUPPLY MOVEMENT

INFORMATION AND TECHNICAL SUPERVISION

FIGURE 10.—Corps quartermaster service as an independent corps.

(3) In general, it is useless to attempt to camouflage a position where work has already begun and where the enemy has had an opportunity to observe and register the site.

(4) Even though it may be impossible to camouflage completely a military work or structure, its visibility should be reduced by disguising its outline and eliminating highlights and reflecting surfaces.

(5) Subsidiary military works or auxiliary structures, such as temporary kitchens or latrines, must be located and camouflaged carefully.

(6) There should be close cooperation among the intelligence sections, Army Air Forces, and camouflage officers in order that camouflage work may be properly executed. Whenever practicable, the counterintelligence plan should provide aerial photographs of our own positions to insure the proper surveillance of the camouflage effort. Camouflage officers should study these photographs in order to correct defective work.

(7) In order that they may perform their camouflage duties properly, responsible officers must acquire an intimate knowledge of the area in which they are to operate. They must learn the photographic values, textures, and character of the materials required, as well as the best means of adapting their work to the terrain. For detailed instructions concerning the use of camouflage, see FM 5-15 and 5-20.

b. Discipline.—The proper concealment of troops from hostile aviation depends in large measure on the understanding by all military personnel of what aerial photographs reveal, and on the degree of camouflage discipline prevailing within the command. Trained troops utilize to the maximum existing roads, trails, and paths before making new ones and avoid making any that are unnecessary.

c. Equipment.—(1) Individual and organizational equipment should be of neutral color material or should be treated with a neutral color flat paint. Metal parts should have a dull nonreflecting finish.

(2) All identification marks, such as divisional, regimental, or lower organizational designations or insignia on all classes of individual or organizational equipment, should be effectively obliterated prior to entry into the combat zone.

d. Cover.—Troops should make maximum use of the concealment afforded by terrain features such as woods, covered routes, and villages. Whenever possible, this should be supplemented by artificial concealment prepared from various materials, such as grass, leaves, or burlap.

e. Darkness.—(1) *Night marches.*—In general, troop movements in the combat zone should be made under cover of darkness with restrictions on the use of lights. The different degrees of restrictions on the use of lights will be defined in orders by the army or theater commander. When troops are being concentrated by night marches, daybreak should find them either in position or under cover in woods or villages.

(2) *Blackout.*—If the enemy possesses a powerful air force, a blackout system must be employed in the theatre of operations. The necessary instructions for this will be issued by the theater commander.

SECTION IX

THE AIR FORCE

■ 95. **GENERAL.**—The general procedures of quartermaster service for ground forces apply equally for air forces, but details of execution vary because of the high mobility of the air force, the rapidity of its concentration, and the wide dispersion of its squadrons. For the ground forces, the service of supply builds up behind the combat troops. For the air force, it must be completely established and in operation before the arrival of the combat squadrons.

■ 96. **MISSION.**—The mission of the Quartermaster Corps in the area or areas occupied by the air force is to furnish the necessary personnel and facilities for the proper quartermaster supply and maintenance of all troops of the air force in the field and the furnishing of Quartermaster Corps supplies and equipment adequate in quantity and quality at the places and times needed. For proper control of operation, the quartermaster service of each air base established in the theater of operations is organized on an area basis under the command of the air base commander concerned, and is operated by the air base quartermaster.

■ 97. DUTIES IN AIR BASE AREA.—*a.* The following general duties are performed by the quartermaster service in each air base area:

(1) Establishment, operation, and maintenance of all quartermaster facilities required by the air base commander.

(2) Procurement, storage, and issue of all classes of quartermaster supplies. Quantities to be procured and the levels to be maintained are determined by the air force commander. Places of issue or distributing points are determined by the air base commander.

(3) Collection and disposal of salvage.

(4) Operation of all means of transportation for the general movement of troops and supplies other than by air, water, and rail.

b. Distributing points are established by the air base commander for requisition and issue of all classes of supplies to air force troops. One distributing point is normally established per auxiliary airdrome within the air base area. One squadron is normally assigned to an airdrome. The distributing point is operated by a representative of the air base commander with a detail of service troops from the air base. Quartermaster personnel consisting of two or three enlisted men from the mobile field section of the air base service unit are assigned to this detail. Supplies are drawn from the distributing point by the squadron concerned.

c. The distribution of all classes of quartermaster supplies is made from the air base depot whenever convenient. In situations where quartermaster distributing agencies, other than those under air force command, and commercial distributing agencies are conveniently located for supply, the air force commander arranges with the responsible parties concerned for distribution and issue through these agencies. The detailed arrangements are completed by the air base quartermaster.

d. Quartermaster class I supplies are issued on a daily automatic basis. Appropriate reserves are stocked at each distributing point for troops served thereat.

e. Other classes of quartermaster supplies are procured by the air base commander by requisition, either formal or informal, on War Department or communications zone de-

pots. The air base quartermaster arranges for distribution of these supplies to troops from stocks in the air base depot, withdrawals against credits, or by requisition on depots not under air force command. In the case of class IV supplies, the requisition must receive the final approval of the air force commander. No stocks of these supplies are placed at distributing points.

SECTION X

THEATER HEADQUARTERS

■ 98. FUNCTIONS.—The Quartermaster Corps service with a theater or task force headquarters exercises general technical direction and control over the administrative, supply, and transportation divisions of the Quartermaster Corps within the command, and in general is charged with—

a. Procurement, storage, and issue of all quartermaster supplies.

b. Issue of remounts.

c. Transportation of troops and supplies, except such as may be allocated to another service.

d. Operation of a labor service and motor pools.

e. Operation of quartermaster service, including bakeries, cold storage and ice plants; gardens; laundries; baths; salvage plants; baggage collection depots; cemeteries; and shoe and textile repair shops.

f. Operation of graves registration service.

■ 99. THEATER QUARTERMASTER.—The official designation of the officer responsible for quartermaster service is theater or task force quartermaster, and his duties in general are outlined in FM 101-5.

■ 100. ORGANIZATION.—The type, strength, and organization of quartermaster units and personnel will be as prescribed by the War Department and published in orders or Tables of Organization.

■ 101. ESTABLISHMENTS.—The quartermaster service maintains personnel replacement depots and supply depots for quartermaster class I, II, III, and IV supplies. The class I

supply depots are organized and stocked to provide automatic supply. Quartermaster depots with balanced stocks of class II, III, and IV supplies are established to meet either immediate or future requirements of the troops. Supplies are usually made available in the form of credits in designated depots. When credits are established for an army in the communications zone depots, calls are made, as necessary, by the army supply service concerned, direct to the proper depot or through the corresponding supply officer at the regulating station. If a call is sent direct to the communications zone depot, a copy is sent to the regulating officer. Shipments are made up and dispatched either through the regulating station or direct to the requisitioning agency. In the latter case, the regulating officer is notified of the shipment.

INDEX

	Paragraph	Page
Accountability, property-----	47	49
Administrative training-----	12	11
Advertising-----	24	19
Air Force-----	95-97	108
Animal:		
Casualties-----	66	68
Replacement-----	67	68
Transportation-----	63-67	65
Applicatory system-----	14	12
Armored Division-----	76-79	91
Arms and Services, relationship-----	4	2
Army, The-----	90-94	101
Basic training-----	10	10
Camouflage-----	94	105
Cavalry Division (Horse)-----	74, 75	87
Classification:		
Supplies-----	19	17
Units-----	70	70
Contracting officers-----	23	19
Contracts-----	25	20
Corps, The-----	84-89	99
Definitions-----	69	70
Distribution-----	31-33	24
Employment, motor vehicles-----	57	62
Essential subjects-----	9	10
Expansion, mobilization-----	54	59
Functions-----	2	1
Fundamental procedures of supply-----	15, 16	13
Funds-----	21	17
General staff, relationship-----	5	3
Infantry Division-----	71-73	72

INDEX

	Paragraph	Page
Inspection:		
Subsistence stores-----	44	46
Supplies-----	28	22
Inventory warehouse-----	39	45
Issue:		
Subsistence stores-----	45	46
Supplies-----	31-33	24
Labor pool-----	37	45
Limitations-----	27	21
Maintenance-----	62	64
Materials-handling-----	36	44
Methods, procurement-----	22	17
Mission:		
QMC-----	1	1
Training-----	8	10
Mobilization-----	54	49
Motor transportation-----	56-62	61
Motorized Division-----	82, 83	98
Mountain Division-----	80, 81	95
Negotiated purchases-----	26	20
Operation:		
Mobilization-----	54	59
Motor transportation-----	61	63
Salvage companies-----	51	54
Organization:		
Motor transport-----	58	62
QMC-----	6-7	7
Remount service-----	53	57
Salvage companies-----	50	53
Subsistence stores-----	41	46
Pack transportation-----	65	67
Performance-----	59	63
Procurement-----	17-30, 43	16, 46
Progressive training-----	13	11
Property accountability and responsibility--	47	49
Purchases, negotiated-----	26	20

INDEX

	Paragraph	Page
Records, warehousing-----	38	45
Relation to other agencies-----	3-5	2
Remount service-----	52-55	57
Reports, procurement-----	29	22
Requirements-----	20	17
Requisitions, subsistence stores-----	42	46
Restrictions-----	27	21
Sales and issues, subsistence stores-----	46	47
Sales company-----	48	52
Salvage-----	49-51	52
Service in divisions and higher units-----	68-101	70
Special Staffs, relationship-----	5	3
Storage:		
Subsistence stores-----	45	46
Supplies-----	31-33	24
Subsistence-----	41-48	46
Supply-----	15-55	13
Tactical training-----	12	11
Technical training-----	11	11
Theater Headquarters-----	98-101	110
Theater of Operations:		
Procurement-----	30	23
Remount service-----	55	60
Storage, distribution, and issue-----	33	35
Training-----	8-14	7
Transportation:		
Animal-----	63-67	65
Motor-----	56-62	61
Units:		
Classification-----	70	70
Training-----	7	8
Wagon transportation-----	64	66
Warehouse officer-----	35	43
Warehousing-----	34-40	43
Zone of the Interior, supplies-----	32	25