

MHI
Copy 3

Dec. 44 / 10

FM 70-10

WAR DEPARTMENT FIELD MANUAL

MOUNTAIN OPERATIONS

THE ARMY LIBRARY
WASHINGTON, D. C.

WAR DEPARTMENT • DECEMBER 1944

WAR DEPARTMENT FIELD MANUAL
FM 70-10

MOUNTAIN OPERATIONS

THE ARMY LIBRARY
WASHINGTON, D. C.



WAR DEPARTMENT • DECEMBER 1944

United States Government Printing Office
Washington: 1944

B
/

WAR DEPARTMENT

Washington 25, D. C., 30 December 1944

FM 70-10, Mountain Operations, is published for the information and guidance of all concerned. This manual should be studied in conjunction with FM 100-5, Operations; FM 100-10, Administration; FM 25-5, Animal Transport; FM 25-7, Pack Transportation; FM 31-40, Supply of Ground Units by Air; and FM 70-15, Operations in Snow and Extreme Cold.

[AG 300.7 (6 Dec 44)]

BY ORDER OF THE SECRETARY OF WAR:

G. C. MARSHALL

Chief of Staff

OFFICIAL:

J. A. ULIO

Major General

The Adjutant General

DISTRIBUTION:

AAF(10); AGF(40); ASF(2); T of Opns(10);
Arm & Sv Bd(1); Tech Sv(2); SvC(2); Gen &
Sp Sv Sch(50) except Inf Sch(500); A(5);
CHQ(3); D(2) except D 1(0); B(1); R(1);
SBn(1); Bn(1); C(1).

For explanation of symbols, see FM 21-6.

CONTENTS

11760
11. 51
1944

MAR 29 1945

Property of U. S. G.

MIC-37-42

Paragraphs Page

CHAPTER 1. GENERAL CONSIDERATIONS 1-5 1

CHAPTER 2. OPERATIONS.

Section I. General 6,7 4

II. Troop movements and marches 8-18 5

III. Security 19-22 9

IV. Bivouacs 23-25 10

V. Offensive combat 26-34 13

VI. Defensive combat 35-40 20

CHAPTER 3. EMPLOYMENT OF THE ARMS AND SERVICES.

Section I. Infantry 41-45 25

II. Artillery 46-57 29

III. Cavalry 58, 59 34

IV. Armored and tank destroyer units 60-62 35

V. Antiaircraft artillery 63 36

VI. Air Forces 64, 65 36

VII. Engineers 66-72 37

VIII. Medical Corps 73-83 48

IX. Quartermaster Corps 84, 85 54

	<i>Paragraphs</i>	<i>Page</i>
CHAPTER 4. CONDITIONING AND ACCLIMATIZATION.		
<i>Section I.</i> General	86-88	56
<i>II.</i> Personal hygiene	89-92	58
<i>III.</i> Maladies	93-95	60
<i>IV.</i> Climate	96, 97	61
 CHAPTER 5. MILITARY ROCK- CLIMBING.		
<i>Section I.</i> General	98-101	63
<i>II.</i> Basic technique	102-108	64
<i>III.</i> Movement of trained personnel	109-111	97
<i>IV.</i> Mass troop movement	112-114	103
<i>V.</i> Movement of equipment	115	108
<i>VI.</i> Tactical employment of climbers	116-122	111
<i>VII.</i> Mountain stream crossings ...	123	116
<i>VIII.</i> Special clothing and equipment	124-126	120
<i>IX.</i> Climbing school	127-132	123
<i>X.</i> Supplementary training	133, 134	129
<i>XI.</i> Exercises in climbing	135-142	131
 CHAPTER 6. WEATHER.		
<i>Section I.</i> General	143-145	141
<i>II.</i> Weather determinants	146-148	143
<i>III.</i> Storms and weather types	149-151	146
<i>IV.</i> Weather prediction methods ..	152-155	148

CHAPTER 7. WINTER CHARACTERISTICS.

<i>Section I.</i>	General	156-158	156
	<i>II.</i> Classification of snow	159, 160	158
	<i>III.</i> Avalanches and cornices	161-165	164
	<i>IV.</i> Movement over snow and ice..	166, 167	174
	<i>V.</i> Dangers of glacial regions ...	168	177
	<i>VI.</i> Movement over glaciers	169-172	179
	<i>VII.</i> Special clothing and equipment	173	190

CHAPTER 8. ADMINISTRATION.

<i>Section I.</i>	Motor transportation	174-179	191
	<i>II.</i> Animal transport	180-183	196
	<i>III.</i> Supply	184-190	199
	<i>IV.</i> Evacuation	191-206	202

CHAPTER 9. COMMUNICATIONS 207-213 224

APPENDIX.	Glossary of mountain climbing terms		231
------------------	---	--	-----

INDEX			237
--------------------	--	--	-----

CHAPTER 1

GENERAL CONSIDERATIONS

1. GENERAL. a. Terrain and weather are important factors in the conduct of mountain operations.

b. Mountainous terrain is usually characterized by one or more of the following: exaggerated terrain features, heavy woods or jungle, rocky crags and glaciated peaks, compartmentation, routes of communication which are limited in extent and of poor quality, extreme weather conditions, or high altitudes. For terrain evaluation, see FM 5-15 and 100-5.

c. Mountain weather is characterized both in summer and winter by inclemency, or by large temperature differences between day and night, and by sudden and localized atmospheric disturbances such as violent rain and snowstorms.

2. ORGANIZATION. a. The organization of the standard infantry division is suitable for operations in low mountain terrain. Only minor modifications will be required to fit a specific situation. These usually take the form of addition of pack transportation and elimination of vehicles and weapons not suitable for the terrain. Complete reorganization and specialized technical train-

For military terms not defined in this manual, see TM 20-205.

ing, as well as the use of special clothing and equipment, will be required for operations in alpine terrain.

b. Tactical units may be organized especially to fit the different terrain compartments.

3. COMMAND. **a.** Decentralization of command is characteristic of mountain operations. All the combat troops, equipment, and services in a terrain compartment are placed under a single unified command.

b. Since the various echelons of the command are often isolated by the configuration of the terrain, by difficulties of communication, and by weather conditions, commanders of subordinate units must often assume more responsibility than in other terrain. All commanders must possess, to a high degree, character and initiative. Combat in *high* mountains demands great detail in planning and preparation.

4. TACTICS. The same tactical principles govern warfare in mountainous terrain as on any other terrain.

a. In rugged mountains there are definite limits to the employment of large forces. Deployment is greatly hindered and restricted. Often adjacent units cannot provide mutual support. Rapid employment and shifting of reserve are difficult in the more restricted positions. Small units have many occasions for sudden and bold action. Opportunities to deceive the enemy are many.

b. Small forces of mountain troops can prevent, impede, harass, or canalize the movements of the main enemy force so that when the decisive battle takes place his troops are dissipated and he is compelled to fight under unfavorable conditions.

c. Soldiers must be prepared to advance over narrow and twisting roads and paths, trackless terrain, steep and slippery slopes, ravines, and precipices.

d. Relatively unimportant rôles are played in mountain warfare by the tank. The employment of heavy infantry weapons and artillery is hampered by their bulk and weight, by the considerable dead space in their fields of fire; and by the difficulties of observation due to bad weather and intervening terrain features. It is the infantry, above all, that must bear the brunt of the battle. The importance of close combat increases as the efficiency of other methods of fighting decreases.

e. The focal points of mountain combat are the heights. Gun emplacements and observation posts on commanding heights can dominate the foreground. Advances are made along ridges, rather than through the natural avenues of approach.

5. LOGISTICS. **a.** Logistical considerations are greatly affected in mountain operations. Time and space factors are never fixed, but vary constantly with the configuration of the terrain, the altitude, the scarcity of roads, the season, and a number of other more routine considerations. In general, a comparatively great amount of time must be allowed for the movement of troops and supplies. Distance is measured in time rather than space. (See also FM 72-20.) Vertical distance between points is often greater than the horizontal distance.

b. The commanding officer must issue orders, fragmentary if necessary, to his subordinates early in the operations because of the time needed for movement of troops and supplies along the small number of steep and difficult routes, and because of the unavoidable delays in bringing troops into position, in modifying their positions, and in organizing supply functions.

CHAPTER 2

OPERATIONS

Section I. GENERAL

6. GENERAL. Mountain terrain lends itself particularly well to surprise, but successful surprise action depends on mountain trained soldiers and a commander who knows how to use them. Decentralization of control is forced upon commanders of large units by prevailing terrain and weather conditions. Hence, the initiative, resourcefulness and judgment of small unit commanders is taxed to the utmost, as they will be operating independently or semi-independently for extended periods of time.

7. STANDING OPERATING PROCEDURE. In order to facilitate mountain operations, a detailed standing operating procedure should be prepared by each unit, including the platoon. This standing operating procedure should cover the organization of combat teams down to and including the battalion, a normal procedure for supply, making bivouacs and emergency shelters, march rates and march formations, and any changes in organization and equipment required for both summer and winter operations.

Section II. TROOP MOVEMENTS AND MARCHES

8. MARCH TECHNIQUE. Troops that have acquired the proper *technique* for marching in mountains are capable of marching many times the distance than can be covered by troops not so trained. The prime consideration is to conserve the soldier's strength and combat efficiency. The individual soldier must acquire a steady rhythmic pace, decreasing in speed with the steepness of the slope. In addition to the effect of the terrain, the rate of march is further reduced by wind, rain, intense heat, and fog. When climbing, the length of the regular pace should be maintained, stepping around rather than over obstacles, and keeping the feet flat. Use of the balls of the feet alone should be avoided. The knees should be slightly bent, and footholds selected carefully. When traversing steep slopes on soft ground it is desirable to kick footholds and to take advantage of natural flat hummocks. When traversing steep slopes on hard ground, the feet should be flat, rolling the ankle with the slope. Logs, sticks, or small rocks should not be stepped on. When ascending steep slopes the rate may vary from 40 to 85 steps per minute, depending principally on the altitude. Over uneven or difficult footing, a 5 foot distance between men allows the soldier to adjust the length of his stride and to keep moving without being forced to halt by the varying speed of the man ahead.

9. EFFECTS OF MARCHING. Improper pace or cadence in marching uphill may result in serious injury to the heart and respiratory organs. Descending pro-

duces continuing jars, the severity of which are increased by the weight of a pack, resulting in strain on the legs, pelvis, and spinal column. Climbing tires the heart and lungs; descending causes great muscular fatigue.

10. RATE OF MARCH. The rate of march may seldom be calculated exactly. To estimate the time required to cover a given distance, add to the time required for marching the map distance 1 hour per each 1,000 feet ascent or 1,500 feet descent. For example, a 10-mile march on a hard surfaced road required 4 hours. If there is a total climb of 2,000 feet and a total descent of 1,500 feet, the march will take 7 hours. Messengers, and those required to move rapidly, may make exceptional speed by running down hill.

11. MARCH DISCIPLINE. March discipline must be rigorously enforced in every aspect. If a man is forced to stop to repair or readjust equipment or because of illness or an injury, he should immediately fall out of the column, and should not try to regain his place until the next halt. All commanders must give continuous attention to keeping marching formations closed to proper intervals. Ordinarily this can only be accomplished at halts. Stragglers must not be tolerated and the taking of short cuts should be forbidden.

12. PACE MAKING AND HALTS. The march unit should be the company, rather than the battalion. An experienced noncommissioned officer, carrying the same load as the majority of the men, and marching at the head of each company, maintains the pace ordered by

the march unit commander. The pace of the column must be governed by the most heavily loaded element, such as the heavy weapons company. It is advisable to make a 5-minute halt to adjust clothing and equipment after the first 15 minutes of marching, and the usual 10-minute halt after the first 50 minutes. At the regular halts men should remove their packs and weapons. Lying down with the feet elevated will help to freshen the legs and prevent stiffness. Troops should be trained to clear the trail immediately at all halts to allow messengers to move along the column.

13. COLUMN LENGTH. When a narrow trail necessitates marching in single file, the length of an infantry battalion may approximate 4 miles. The difference in elevation between head and tail may be over 3,000 feet. On a winding ascent, the trail distance between the point and the main body may be 2,000 yards, although the cross-country distance may be only a few yards. Under such conditions, the main body may be closer to the enemy than the point and may be fired upon at the same time as the point, or even before the point is engaged.

14. SELECTION OF ROUTES. a. Reconnaissance of routes of march should be made and the route selected on the basis of ease in marching as well as tactical security. Factors governing the choice are availability of ridge routes, good footing, contour travel, timber lines, and geological formations such as ledges. Primitive trails are usually found along ridges. Highways usually follow the valleys. Movement down a valley, without security on the high ground, invites ambush. Movement on the crest of a ridge, where some of the best trails are

found, invites observed artillery fire. In an uncovered march, a unit should march below the crest of the ridge with flank security below both military crests observing the valleys.

b. Timing and planning are important in order to avoid halts or bivouacs on exposed terrain.

15. SELECTION OF OBJECTIVES. Because of optical illusions created by clear air, looking down from heights, and intervening depressions, time and distance will invariably be underestimated. Particular care must be taken to select an objective which can be reached within the time available. The route and alternate route to the destination should be reconnoitered in advance. One unexpected extension of a march will often produce undue exhaustion which, in turn, will result in a late arrival, a poorly prepared bivouac, and inefficient security.

16. MOVEMENT OVER DIFFICULT TERRAIN.

a. Movement over extremely difficult terrain such as cliffs, rocky crags, ravines, glaciers, or deep snow, require special preparation, training, technique, and equipment. (See chs. 5 and 7.)

b. On steep slopes, columns of pack animals should not be permitted to get off the trail. Foot troops should negotiate such slopes by traversing, or ziz-zagging.

17. NIGHT MARCHES. When contact with the enemy is imminent or has been gained, most of the marching will be at night. Night marches in mountains are very difficult, often dangerous, and excessively tiring, and therefore should be attempted only when absolutely

required by the situation. Daylight reconnaissance and marking of routes to be used, as well as competent guides, are essential to the success of a night march. Distances between men, animals, and units are decreased. While bright moonlight makes a night march easier, it also improves enemy observation. It is extremely difficult to move along a rocky path at night without noise. Dislodging of a single rock may start a rockslide that can be heard over a mile away. Hoofs of pack animals and hobnailed shoes will create telltale sparks. When marching through woods or areas where trails are many and indistinct, numerous connecting files will be required between march units in order to maintain continuous contact. It is usually impossible for anyone to move up and down a column on a mountain path at night to check on distances and maintain march discipline. All orders must be relayed backward and forward through the column.

18. MARCHES IN CLOUDS OR FOG. Marches in clouds or fog present the same difficulties as night marches. Keeping a sense of direction is more difficult, since clouds are often so dense that one can hardly see the ground. Such conditions necessitate even closer columns, a slower pace, and the use of audible signals. The crowding together of units may cause serious tactical disadvantages when the fog or cloud lifts. Lifting of fog may occur very quickly; when this occurs, no time should be lost in resuming normal formations and distances.

Section III. SECURITY

19. GENERAL. a. Mountain terrain offers many vantage points for enemy observation and ambush thus

requiring the placing of unusual emphasis on security. Commanding ground must be occupied immediately by security detachments strong enough to hold it against hostile combat or reconnaissance patrols. Enemy positions that are not readily accessible to our troops without undue loss of time may have to be neutralized by air attack, artillery, or infantry heavy weapons, so as not to impede the progress of the main body.

b. When opposed by well trained and aggressive enemy mountain troops, no mountain ranges or terrain obstacles can be considered as insurmountable, and every conceivable approach must be guarded. The nature of the terrain and network of communications will usually force the enemy to concentrate on one or two outposts and he will rarely attack several outposts at once.

c. At night, enemy infiltration is a constant danger, especially to rear installations. The use of additional troops may sometimes be necessary in order to protect rear installations adequately.

20. LISTENING POSTS. A man's voice in a valley frequently can be heard on ridges 3,000 feet above. Therefore listening posts are usually placed well up on a ridge. Mountain streams often drown out all noises for those near the stream when those higher on the ridge can distinguish each distinct sound.

21. FLANK SECURITY. a. Because of the great amount of time normally required for flank security forces to reach and occupy dominant terrain features, they must move well in advance of the main body, and preferably are mounted or motorized. In the winter, highly trained ski troops should be used for such difficult

and exhausting missions. If the sides of a valley are very steep and rise 3,000 to 4,000 feet from the valley floor, as is often the case, the strength and number of flank guards and patrols, and the number of reconnaissance patrols, will have to be increased.

b. Every commander must consider the physical limitations which the terrain imposes on the route selected for any security detachment. Communication between security elements and the main body, often impossible except by radio, is another limiting factor. Roads or trails, paralleling the route of the main body are seldom available. Therefore, the movement of patrols across country over rough and difficult terrain becomes so slow and fatiguing that fixed flank patrols should be dispatched to occupy vantage points along the route of march. Trained dogs for use in security and messenger work are particularly valuable in mountain operations.

22. ANTIMECHANIZED SECURITY. Surprise raids by armored elements are rare, but should nevertheless be guarded against by means of road blocks, mines, and antitank guns.

Section IV. BIVOUACS

23. GENERAL. a. Most mountainous regions offer few camp sites suitable for large units. The limited areas and the increased time lengths of columns will usually require battalions or companies, or even platoons, to bivouac separately on the nearest suitable spot to the halting point. This method will not necessarily expose subordinate units to any great danger, as even a platoon organized for all-around defense, can success-

fully withstand an attack by a larger force until supported by adjacent units. The best camp sites are on gentle slopes, near streams and in wooded areas. Above the tree line, tents and animals must be well dispersed and camouflage discipline strictly enforced. In general, mountain bivouacs should be located on commanding ground with provisions for all-around defense of the area. Unprotected small units should never bivouac in a valley in the presence of the enemy, as they do not possess sufficient force to outpost the surrounding high ground.

b. For bivouacs in snow and extreme cold, see FM 70-15; for bivouacs in jungle, see FM 72-20.

24. FORMATIONS. **a.** The company may bivouac in a formation suitable for perimeter defense as described in FM 7-20. If sufficient overhead cover is available, the company should bivouac astride the road or trail being used, with trails made for the flank platoons. The use of platoon bivouacs will further reduce the time required to close up at night and to move out in the morning.

b. The battalion commander, when issuing his order to halt, should indicate whether the battalion is to close into platoon or company bivouacs, depending on the density of cover, the time length of the column, and his mission the following day.

c. The actual set-up of bivouacs will vary considerably due to the irregularities of the terrain. Living conditions are continually improved if the same area is to be used for more than one night. All types of shelters may be dug in the side of a slope, using shelter halves or pieces of canvas covered with grass or branches for

roofing. On a fixed front, bomb proof caverns may be blasted out of bed rock and used for supply storage as well as quarters. (See FM 70-15.)

25. PRECAUTIONS. a. Smoke from a fire in a valley will often rise in a column that can be seen for several miles. Lights at night can be seen from distant visible peaks. Exposed lights or fires should never be permitted under combat conditions. The flash of a meat can in a mess line can expose an otherwise well-concealed bivouac. The outside of all mess gear should be blackened and no items of equipment which reflect light should be exposed.

b. Tents, equipment, and supplies should not be placed too close to dried-up stream beds during the summer months, as sudden rainstorms and cloud bursts may turn the beds into raging torrents.

c. Bivouacs should not be placed where rockfalls and avalanches threaten.

Section V. OFFENSIVE COMBAT

26. INFLUENCE OF TERRAIN. a. Mountain combat lacks the unity characteristic of combat in rolling terrain, particularly in the offensive phase. The configuration of the terrain tends to give battle a piecemeal character and to divide it up into more or less isolated conflicts difficult to control by higher commanders. Subordinate unit commanders must maintain their initiative within the plan of the given mission and in accordance with the expressed intentions of the higher command.

b. Offensive action is characterized in all its phases

by surprise attacks and attempts at flanking maneuver, combined with frontal action on a broad front. In all offensive operations, the seizure of dominant terrain features as intermediate and final objectives becomes the core of the commander's plans. Specific effort to capture vantage points for artillery observation must be emphasized.

c. In order to advance successfully, troops should ordinarily work along ridges and high terrain features, avoiding natural corridors of approach, which are usually mined and easily defended. In this manner the enemy will be forced to abandon strongly defended positions in the valleys and natural approaches as they are bypassed. The peaks and ridges will generally be heavily defended by the enemy, and seizing the high ground will usually necessitate a frontal attack. By moving up the noses of the subsidiary ridges instead of the draws, the cost of such an operation will be reduced.

d. Restrictions imposed by the terrain usually limit the size of units employed. A reinforced battalion is the largest force which will normally be employed as a unit in the attack.

27. ORDERS. **a.** The attack order should emphasize objectives and routes of advance rather than boundaries or azimuth direction of attack. Successive objectives will ordinarily be assigned.

b. In rugged terrain, unusual and unexpected opportunities will often present themselves to small unit leaders. If these advantages are rapidly and aggressively exploited, the whole action may be influenced. Because of this, junior leaders should have some knowledge of the over-all picture; orders must be general, allowing

initiative on the part of subordinates; and the higher commander must be quick to seize the advantage gained by one of his smaller units.

28. DETACHED MISSIONS. Units sent on an independent mission or on a flanking mission should be of such composition that they can accomplish the mission without additional support. Reinforcing a unit will often be impossible because the length of time required to move reserves is prohibitive. Supporting a unit by fire will often be impossible because of intervening ridges.

29. APPROACH MARCH. a. In a march along a narrow ridgeline trail, the column length of a battalion may be as much as 4 miles, and the time length, several hours. Reinforcement of the advance guard, therefore, may take 4 or 5 hours if movement must be across country. Each unit should be self-supporting for sustained combat. The advance guard may be composed of one rifle company reinforced by elements of the heavy weapons company and a detachment of the ammunition and pioneer platoon, the latter depending upon the condition of trails and the availability of engineers. Elements of a pack howitzer battalion if available, may also be attached to the advance guard. The rear guard may be one rifle platoon reinforced by light machine guns of its company and by elements of the heavy weapons company. This plan will apply when limited ridgeline trail nets prohibit the use of more than one trail. When more trails are available, or when combat is imminent, parallel columns, a wedge formation, or a formation with a unit on each ridge and the main body in the valley in rear can be used. In all cases, each unit separated from the main body must be capable of fighting without support.

b. Because of the time required to reconnoiter enemy positions and because of the constant possibility of ambush, the rule, "Contact once gained should never be lost," is especially applicable.

c. Lateral contact between adjacent units is seldom continuous, and connecting patrols must be dispatched frequently. Combat patrols must be sent to the flanks to cover areas that have been bypassed.

d. When the enemy abandons a position without strong resistance and high casualties, patrols must be dispatched and pursuit carried out cautiously, as the enemy may be organized for combat on a more advantageous position.

30. ATTACK. **a.** Flanking action will sometimes be impossible and the unit will be required to attack frontally.

b. Frontal daylight attacks in narrow sectors have little chance of success. Such attacks are bound to be canalized and observed, thus giving the enemy the opportunity to shift his reserves for counterattack. On the other hand, if the attack is launched quietly and stealthily at night, without initial supporting fires, there is a greater chance of getting through for a surprise assault without being exposed to observed and concentrated fire. Upon reaching the proximity of the enemy position, and as soon as there is sufficient daylight, the infantry commander should request artillery and mortar fire on observed enemy positions and troop concentrations in order to break up any possible counterattack.

c. Simplicity of plan is the essence of a successful night operation. Such planning must provide for con-

tinuous, effective control by the commander, and for alternate action in the event that unforeseen developments arise. Characteristics of night attacks in the mountains are:

(1) Comparative ease in maintaining direction (usually uphill).

(2) Difficulty in maintaining control.

(3) Slow and methodical movement.

d. The attack of a very steep position is frequently made easier by the great amount of dead space. Halts should not be made on top of a ridgeline objective. Advance over crests should be made cautiously, in a well-deployed formation. The attacker should continue to push the enemy toward the next objective, or dig in and reorganize well forward of the ridge crest. In case of a halt to reorganize, leaders of assault units should dispatch combat patrols to maintain contact with the enemy.

e. The crossing of a lateral valley and assault of a well defended ridge are similar to the forcing of a river-crossing. The purpose is to move a force across quickly and economically and establish a bridgehead to permit the crossing of the main body. This requires careful reconnaissance, coordination of supporting fires, and finally a carefully planned attack, preferably with the use of smoke or at night. *To move the entire force from the ridge into the valley before the next ridge has been secured, is to invite disaster.*

f. Battalion command posts should be close to the front. This enables messengers to perform their missions more rapidly with less chance of being lost, and battalion staff officers to give closer personal supervision to the operations. Although close to the front lines (200 to

500 yards), the pronounced defilade and the proximity of supports and reserves will often give the command post protection from enemy fire and infiltration.

31. SUPPORTING WEAPONS. a. Infantry heavy weapons, artillery forward observers, and survey parties should closely follow advancing infantry to commanding ground in order to give continuous support to the attack. All infantry officers should be able to adjust the fire of supporting weapons.

b. The normal employment of cannon company howitzers for close support is usually impracticable. The cannon company is usually employed, under regimental control, to supplement the fires of the supporting artillery battalion.

c. Because of the difficulties of ammunition supply, the standing operating procedure or field order should include the percentage of field artillery and mortar ammunition to be retained for close support of the assault and for breaking up a counterattack. In addition, a fixed number of rounds should habitually be kept in reserve to be used only on the order of the unit commander.

32. USE OF SMOKE. The use of smoke in various phases of mountain operations assumes a high degree of importance. Smoke often must be used in daylight frontal attacks, stream crossings, withdrawals, and for marking and identifying positions, targets and objectives. Weather conditions such as snow storms and fog may supplement smoke in concealing the attacker.

33. EXPLOITATION AND PURSUIT. a. Each local success should be exploited immediately and vigor-

ously by utilization of reserves for flanking attacks on adjacent enemy points of resistance, seizure of his communication centers, and cutting off the retreat of isolated enemy forces. By interdiction fire the artillery should cover to the limit of its range every conceivable escape corridor. Frequent forward displacement of artillery is so time-consuming that it is tactically unsound unless the guns are so emplaced initially that they can be moved forward on a road parallel to the axis of advance or penetration. Participating aviation, if available, should be called upon to attack retreating columns with its maximum strength, especially at centers of communication and defiles. During exploitation, the security of rear areas must be assured against action by small enemy groups which may emerge from areas of doubtful passability.

b. The fatigue of the attacking troops will exceed that of the defender. For this reason, the troops of the attacking echelon should not be used in the pursuit. Reserve troops can be effectively used, particularly if committed just prior to the capture of the objective.

c. If no fresh troops are available for the pursuit, patrols heavily reinforced with automatic weapons and, when appropriate and practicable, mortars, may be ordered to follow the enemy closely and continue to force him back. This will help to prevent counterattack.

34. ATTACK AGAINST A FORTIFIED POSITION.

a. Attack against a fortified position is extremely difficult in mountains and requires more time for planning, organization and preparation than in ordinary terrain. Careful and continuous reconnaissance, supplemented by the study of vertical and oblique aerial

photographs, is essential. The gaps in fortified positions, defended only by mobile troops, may be expected to be heavily mined and in a more irregular pattern than in ordinary terrain. (See FM 31-50.)

b. Surprise flank attacks, coordinated with attack on rear areas by airborne troops, and supported by highly concentrated and accurate artillery preparations at the critical points, may be employed in order to break through fortified positions.

Section VI. DEFENSIVE COMBAT

35. ADVANTAGES. a. Regardless of the size or composition of the units involved, defensive combat in the mountains has the following advantages:

(1) Dominant terrain provides the defender, and denies the attacker, observation and firing positions.

(2) The slopes and other terrain features impose difficulties on the attacker.

(3) There are zones which are either impassable or extremely difficult for the enemy to negotiate.

(4) The lack, or scarcity, of roads places restrictions on the use of tanks or other combat vehicles, and renders them extremely vulnerable.

b. The inherent advantages may be increased to a great extent by man-made obstacles combined with long-range observed artillery fire and aerial bombardment along enemy routes of advance. A small number of well placed demolitions is often sufficient to stop for a long time all enemy movements on a large section of the front.

c. Mountainous terrain permits the defender to deceive the enemy as to his strength, purpose, and dispositions.

Although it is difficult to move reserve units, the defender can usually accomplish such movement more rapidly than the attacker, since the former has more time to prepare a network of lateral trails and his troops are ordinarily less fatigued.

d. Delaying action is particularly effective in mountains and can be accomplished by a much smaller force than is ordinarily needed. Roads and trails can easily be made impassable for a long time by creating rock-slides and blasting craters on the steepest parts, in narrow passes and, in general, where the obstructions cannot be bypassed or easily removed.

36. DISADVANTAGES. The disadvantages of defense in mountains are:

a. The compartmentation makes it difficult, or impossible to shift fires of supporting weapons readily.

b. It is usually difficult to maneuver support and reserve units to execute counterattack plans.

c. Grazing fire is often impossible in rugged mountain terrain.

d. Mountains with wooded slopes, and moderately difficult cliffs, enable the enemy to make decisive surprise attacks at several points.

e. Difficulty or digging necessitates longer time for organization of positions.

37. SELECTION OF POSITIONS. **a.** The selection of defensive positions is governed by the necessity for—

(1) Barring routes of penetration which the enemy might use.

(2) Protecting routes of communication for the de-

fense, especially important cross-roads, bridges, and lateral roads which might be used by the reserves.

(3) Protecting the flanks by placing them against deep ravines, vertical cliffs, or other areas difficult to penetrate.

(4) Covering all areas of the front, no matter how inaccessible to the enemy they may appear to be.

(5) All-around defense, particularly since terrain considerations may necessitate the organization of defensive positions on successive ridges.

(6) Forming a system of mutually supporting, independent tactical groups which will cover all key terrain features of a defensive area. Ravines should be covered by mortar fire and blocked by antipersonnel mines and barbed wire or other obstacles.

(7) Effective observation of all hostile approaches in order to have early information of enemy movement and troop concentrations.

b. The use of a preponderance of automatic weapons is of greater importance in mountainous terrain than in normal defensive situations. Bare ridges can often be better covered by automatic fire from an adjacent ridge than from any position on the ridge itself. Lateral communication between these mutually supporting groups should be established. Visual signals such as smoke, flags, or pyrotechnics are usually the most dependable.

c. When occupation of a forward slope would subject the defenders to heavy observed fire, it may be best to leave only a combat outpost on the military crest and place the main line of resistance on a favorable reverse slope. Such a location for the main line of resistance will put the enemy in an unfavorable position for observation, employment of heavy weapons, and deployment, and will give the defending weapons favorable positions

protected from observed artillery fire. The more difficult the defense of a position, the more important it is to have active patrols well forward to discover the dispositions of enemy forces. (See FM 7-20 and 100-5.)

38. COUNTERATTACK. Counterattacks, when launched down a descending slope, have the advantage of developing quickly with relatively little physical exertion. If the slope is under enemy observation, a deep counterattack is impracticable. When it is carried out on a reverse slope or directly behind a topographical crest immediately following a stubborn defense of the crest, it may surprise the enemy before he has been able to establish himself.

39. WITHDRAWAL. a. The usual difficulties encountered in any withdrawal are increased when such an operation becomes necessary in the mountains. Pursuing troops can infiltrate and outflank if they advance rapidly on routes parallel to the axis of communication of the defender and emerge along lateral routes on the flanks or in the rear. In addition, limited trail and road nets hamper the withdrawal of equipment and supplies.

b. When a retirement becomes necessary, the defenders should provide delaying detachments, supported by a system of obstacles, to cover the most critical cross-roads and lateral routes. By taking advantage of natural strong positions, and by providing the detachments with a preponderance of automatic weapons, the strength of such detachments may be held to a minimum.

c. The retirement of the forces engaged in the various terrain compartments must be closely coordinated to prevent the cutting off of some units, or sudden break-

through by the enemy, which may result in the partial or total destruction of supply columns and a disorderly retreat.

d. Artillery and aircraft should concentrate their fire and bombardment on points where the enemy must pass through narrow gaps or over obstacles.

40. FORTIFIED AREAS. Mountain terrain lends itself to the establishment of strong fortified areas. For a discussion of the defense of fortified areas, see FM 31-50.

a. In valleys containing the principal routes of communication, strongly fortified areas may be organized. These defenses will generally consist of tiered works, beginning at the lowest elevation in the valley in order to enfilade the main route. Others on the slopes are usually responsible for the opposite slope and long range interdiction. In addition all approaches to the valley are covered with extensive fields of antitank and antipersonnel mines and other obstacles.

b. Because the gaps and flanks are the most likely points of attack, the bulk of fire power should be concentrated at such points. Every effort should be made to hold these positions at all costs.

CHAPTER 3

EMPLOYMENT OF THE ARMS AND SERVICES

Section I. INFANTRY

41. TACTICAL PRINCIPLES. a. Because of its self-sufficiency, great mobility, and versatility in the use of its many weapons, infantry must necessarily carry the chief weight of combat in mountains and must often fight for long periods without the support of other arms. Not only must small units be able to function under decentralization of control, but also each soldier must be able to depend upon himself for leadership and initiative when separated from his immediate superior.

b. As in flat country, infantry acts by means of fire and maneuver, but this method has a somewhat different application in the mountains. In general, the effect of fire is less than in average terrain, since mountainous regions offer considerable natural cover such as rocks and cliffs. Maneuver is constantly hampered by the difficulties of the terrain, and fire support from adjacent units cannot always be counted on. Movement will usually take the form of individual infiltration or successive rushes by small groups for very short distances.

42. FACTORS GOVERNING USE OF WEAPONS.

In the employment of infantry weapons the following factors must be taken into consideration:

a. The use of overhead and long-range fire can be greatly increased due to the great differences in elevation and the good observation afforded.

b. The slopes of the terrain greatly affect range estimation. An observer looking downward from a height is likely to underestimate the distance; an observer looking upward from low ground is likely to overestimate the range.

c. The steepness of slopes and irregularities of the terrain counteract the effect of the grazing fire of automatic weapons and limit the extent of beaten zones.

d. The existence of a great amount of dead space gives added importance to weapons with a high angle of fire, as well as to hand and rifle grenades.

e. The difficulties of ammunition supply make it necessary that all commanders enforce a strict economy of fire.

43. EMPLOYMENT OF SUPPORTING WEAPONS.

a. Machine guns. In employing machine guns, frontal fire is the most commonly used and has the advantage of being effective deep in the region through which the enemy must operate. The terrain frequently permits sustained overhead fire. However, the best positions for frontal fire are often the easiest for the enemy to locate and the displacement of weapons on forward slopes is both difficult and dangerous. As the enemy closes in, the great amount of dead space and steep angle of fire render frontal fire less effective.

Flanking fire may be delivered from ridges, gulleys, and passes protected from enemy fire and observation.

b. Mortars. Mortars are indispensable to mountain operations.

(1) The 81-mm mortars may be attached to companies for marches, bivouacs, and the development for combat. When the battalion makes a coordinated attack, or is defending a narrow front, they are held usually under battalion control. When a regiment beyond the range of its supporting artillery makes a coordinated attack, all 81-mm mortar platoons may be grouped under regimental control and used to support the main effort. When they are so used a detachment from the regimental communication platoon may be added. In the attack it may often be impossible to provide sufficient ammunition for all of the 81-mm mortars. Under such circumstances it is better to advance fewer mortars. This can usually be determined in advance by considering how far from the nearest road the mortars will be expected to operate.

(2) The 60-mm mortar is an ideal supporting weapon for mountain combat because of its portability, ease of concealment, and ammunition supply. If necessary, one man, using a packboard, can carry a mortar complete with base plate and bipod. The light weight of the weapon facilitates its emplacement and use in the most inaccessible terrain.

(3) The employment of 4.2 chemical mortars is very desirable since they can fire either smoke or high explosive shells at a greater range than the mortars of the infantry regiment.

c. Antitank guns. The 57-mm gun is limited in its employment to the few roads that may exist. Since tank

threats are canalized, sufficient antitank protection can usually be furnished by antitank grenades and rockets, and mines and other obstacles. The 57-mm gun can be used to advantage however, as protection for the rear when a unit enters a mountainous region, or as an infantry assault gun against fortified areas. There are occasions when the gun can be manhandled with the aid of block and tackle, or winch. When not employed on one of the above profitable missions, the antitank personnel can best be used in the hand carry of ammunition to forward rifle units and to supplement communication personnel with additional wire carriers.

d. Cannon company. Close support by the infantry cannon company weapons is seldom possible in moving situations. They can frequently be used to better advantage when attached to supporting artillery and employed as additional firing batteries. On a fixed front, however, the accurate observed fire of infantry howitzers and forward antitank guns is of great value in neutralizing enemy machine gun nests.

44. SNIPERS. Due to the fine visibility and observation, frequent opportunities arise when snipers can be used. The development and effective use of snipers should be given special attention.

45. GRENADES AND ROCKETS. **a.** Hand grenades can be used to great advantage in mountainous terrain. Close combat among rocks and cliffs reduces the effectiveness of short range rifle fire, but increases the effectiveness of hand grenades, particularly when they can be thrown downhill. They are very effective in wiping out machine gun nests and mopping up field fortifi-

cations. Men should be cautioned against throwing hand grenades uphill in places where they are likely to roll back on their own troops.

b. When the range exceeds that of the hand grenade, the antitank rifle grenade and rocket are excellent weapons for use in the neutralizing of pill boxes, bunkers, and machine-gun emplacements.

Section II. ARTILLERY

46. TACTICAL PRINCIPLES. **a.** The basic tactical principles for artillery remain valid in mountains, subject to the limitations imposed by the adversities of terrain and weather encountered in mountains.

b. All types of artillery can be used in the mountains. Light and medium artillery may be brought into position with the aid of trucks, tractors, horses or mules, and by the use of block and tackle or winches. Heavy motorized artillery is limited to roads and their immediate vicinity. Pack artillery, which can follow the infantry off mountain trails over comparatively rough ground, provides the most dependable weapons for close and continuous support.

47. LIMITATIONS. **a.** In mountain warfare, artillery frequently is forced into decentralized employment because of the limited space for gun positions and the difficulty of fire control.

b. Occupation of positions and replenishment of ammunition are much more difficult and more time-consuming than in level country.

c. In order for the field artillery to perform its mis-

sion it will frequently be necessary to bring field pieces into positions which can be reached only by manhandling and roping. All gun crews expected to operate in mountains should be trained in roping and rigging.

d. In order for the artillery to provide continuous support it may be necessary to displace more frequently than in average terrain.

48. COORDINATION WITH INFANTRY. Communication between artillery and the attacking echelon of the infantry, and the coordination of its fires with those of infantry heavy weapons require special care. The attacking echelon needs highly effective support up to the very point of penetration. Without such support, it is likely to draw fire just before reaching its objective. An infantry attack over rising terrain is easier to support up to the moment of penetration than one over descending terrain, although artillery fire may dislodge rocks which will endanger the advancing troops. In the final stage of the attack, machine guns and mortars must often take the place of artillery.

49. ARTILLERY IN PURSUIT. In a pursuit through mountains, artillery fire is needed to help overcome the resistance of enemy rear guards. In such action, the timely resupply of ammunition becomes the critical problem.

50. ARTILLERY IN DEFENSE. Artillery defensive fires in mountains must be more carefully planned and prearranged than in other terrain. Areas of enemy approach that are in dead spaces for field artillery fire can usually be covered better by infantry mortars.

51. POSITIONS. a. Good gun positions are usually few in number. They should be selected for defilade, cover, and accessibility to road nets. In general, gun positions on commanding terrain are preferable to low positions. They are better for performing antitank missions, are less exposed to small-arms fire from surrounding heights, have less chance of being caught in rock-slides or avalanches, and reduce the amount of dead space in the target area. Care must be taken, however, that positions on commanding terrain have defilade. When speed in the occupation of positions is essential, a unit must often take the most convenient available position, even a stream bed or the road itself. Reconnaissance for better positions should be continuous and intensive. Camouflage nets should always be used in open terrain. All men, animals, vehicles, and equipment in proximity to gun positions should be kept in defilade.

b. When time is available positions should be prepared with complete survey, including dead space charts. Wire communications should be installed or a complete plan and reconnaissance made for their installation. Radios should be tested in their selected location. Gun positions should be completely prepared, with emplacements, ammunition pits, dugouts for personnel, posts for sentinels, and complete camouflage. An initial supply of ammunition should be stored at the gun positions. Routes of approach should be pioneered and improved. Observation posts should be selected and prepared. Firing data should be prepared for all probable targets. Finally, a complete standing operating procedure for occupation should be developed and rehearsed in advance.

52. OBSERVATION. a. Since the field of vision from the observation post will often extend up to the point of penetration, but not deep into enemy terrain, forward observers should accompany the attack echelon. Additional observation should be furnished by artillery liaison aircraft. Observation posts should normally be on the highest practicable points. Care must be taken, however, to echelon them in height in order to avoid the possibility of all observation posts being blanketed by layers of clouds or fog. Observation posts should be pushed boldly forward to peaks overlooking the enemy positions. At least two forward observers per firing battery are desirable. In heavily wooded terrain, forward observers and liaison officers should be supplied with lineman's climbers.

b. In order that forward observers may reach the best points of observation, it is often necessary that they be qualified assault climbers. Forward observers and liaison officers and their parties, trained in assault climbing, can accompany the infantry in ascending and descending the most difficult mountains.

53. USE OF VEHICLES. Motorized artillery will be confined to roads and trails. Since this road net is usually very limited, it is often advisable to strip batteries of as many vehicles as can be spared. Since the limited road nets of mountainous regions are especially vulnerable to enemy artillery fire and aerial bombardment, infiltration should be the normal method of march. It is often impossible to turn vehicles around on mountain roads; hence security and reconnaissance elements should be far enough ahead to determine the advisability of moving beyond each turn-around point.

54. TARGETS. Because of the difficulty of supplying ammunition, the selection of targets and the allotment of ammunition is of great importance. Care must be taken to avoid wasting ammunition on unprofitable targets. Because of the decentralized nature of mountain operations, targets warranting great masses of artillery fire may be fewer than in other terrain. One type of target which will be especially profitable, however, is a narrow defile which is being used as a route of supply, advance, or withdrawal by the enemy and upon which interdiction fire or heavy surprise concentrations can be placed. Another type of target often found in the more precipitous mountains is that presented by a large mass of snow or rocks above enemy positions. Such masses can be converted into highly destructive rockslides and avalanches by artillery fire. Avalanches accounted for more than half of the casualties inflicted in the alpine fighting of World War I.

55. COMMUNICATION. The two principal means of communication, radio and wire, should be supplemented by visual signaling. Intelligent and energetic use should be made of all available means of communication.

56. FIRE CONTROL. a. The problems of gunnery in mountainous terrain are characterized by large angles of site, large areas hidden from observation, and the increased amounts of dead space.

b. High angle fire should be employed to the fullest extent.

c. In mountainous terrain all fires should be observed. If an observed firing chart is prepared without the aid of survey, the gun positions should be plotted on adjusted

quadrant elevations as this will best account for the variance in site between targets and batteries. A grid sheet based on an accurate survey is the best firing chart. Survey should be initiated as soon as possible. Registration on numerous check points is essential.

d. Care should always be taken in measuring minimum elevation for all parts of the battery's zone of fire as all high points may be occupied by friendly observers.

57. LIAISON PLANES. a. Liaison planes are necessary for observation in mountain terrain. They may also be assigned to follow the progress of an attack in order to inform the commander of the most advanced points reached by infantry or to supply advanced units. However, this requires planes to fly low and thus expose themselves to small-arms fire echeloned in height along the mountain slopes.

b. Liaison planes also provide quick and reliable means of sending messages.

c. In high mountains, liaison planes will not be able to operate because of their limited maximum elevation.

Section III. CAVALRY

58. HORSE CAVALRY. a. Horse cavalry may be very useful in the mountain for reconnaissance and security missions.

b. Cavalry units may be used to good advantage in surprise raids on enemy communication lines and may even be used as reserves, because they can transport their

fire power greater distances with less fatigue than the infantry.

59. MECHANIZED CAVALRY. Mechanized cavalry carries out its normal functions (FM 100-5), to the extent that the terrain and road net permits. Since its movements are canalized and restricted, it is very vulnerable to ambush.

Section IV. ARMORED AND TANK DESTROYER UNITS

60. TANKS. Tanks cannot be employed to the best advantage in mountain terrain, although they may be used by large units in broad valleys and on extensive plateaus. With the exception of their use in such regions, they can be employed only in small units for limited objective operations. (See FM 17-33.)

61. TANK DESTROYERS. Tank destroyers have the same limitations as tanks in mountain terrain. For details of their employment see FM 18-5.

62. EMPLOYMENT. Supply difficulties of tank and tank destroyer units are an important factor in their employment in mountains. In addition, their movement along trail nets may seriously impede the flow of supply for other units. Unless adequate provision can be made for their movement and supply without interfering with the movement and supply of the infantry forces engaged, it is preferable to postpone their employment until more favorable terrain and tactical considerations are encountered.

Section V. ANTI-AIRCRAFT ARTILLERY

63. EMPLOYMENT. Antiaircraft artillery missions in mountains are the same as those in other terrain, but the mobility of the weapons and the effectiveness of the defense are impaired by the lack of roads and the consequent inaccessibility of some of the best positions. It may be necessary to eliminate the guns and employ only the automatic weapons. The fact that low flying planes usually follow routes marked by prominent passes and large valleys facilitates antiaircraft defense.

Section VI. AIR FORCES

64. MISSIONS. The primary missions of the air forces in mountain operations are to gain and maintain air superiority; to observe and attack enemy communication routes, personnel, matériel, and installations; to maintain an active air defense system; to furnish visual, photographic, radar, and weather reconnaissance information for use of air and ground forces; and to facilitate liaison and supply of units separated by impassable terrain obstacles.

65. RECONNAISSANCE. a. Aerial observation is important and should be used to the full extent of its availability. The obstructions offered by terrain to ground means do not apply to the airplane.

b. Aerial reconnaissance can penetrate ravines, slopes, and defiles in a manner not easily done by ground means. Aerial photographs can disclose roads, trails, watersheds, the skyline, defiles, and defiladed areas. They may also

disclose many enemy installations, minor defenses, and concentrations.

c. Vertical photographs of mountains are distorted by the accentuation of the relief and are difficult to assemble. Aerial photographic reconnaissance affords the commander of the ground troops a very useful aid for studying the terrain both superficially and in detail. On snowy backgrounds, aerial photographs give very precise information about traffic, bivouac areas, troop dispositions, and the position of enemy artillery.

d. Oblique photographs and panoramas show the terrain as similar to that seen by ground observers from high points. They make it possible to study steep slopes, determine details which cannot be seen in vertical photographs, discover enemy positions behind ridges, align certain points, and correct mistakes on maps.

e. The interpretation of photographs taken in the mountains is more difficult than of those taken elsewhere and requires thorough knowledge of mountain terrain characteristics. The interpreter should be well acquainted with mountains as seen both from ground observation points and the air.

f. Night reconnaissance is very difficult because of the confused nature of the terrain and the darkness at the bottom of valleys. Moreover, the planes should regulate their flight on the highest summits and, at these altitudes, the results of observation may be of doubtful value.

Section VII. ENGINEERS

66. MISSIONS. A large proportion of troops operating in mountainous terrain should be engineers. The basic mission of the engineers has to do with routes of

communication, and their maintenance, improvement, and repair; the construction of new routes; and demolitions. Mountain roads and trails require extensive improvement with increase of traffic and severe weather conditions. The route of communication problem is further complicated by enemy demolitions activities, leaving road blocks, destroyed bridges, landslides, and buried mines. The duties of engineers also include the organization of permanent positions, an important task because of the difficulties caused by the rocky nature of the ground. There are other special missions, such as the construction of shelters and field fortifications and the installation and operation of aerial tramways and cableways. In order to accomplish efficiently the work assigned to them, engineers should be supplied with mechanical aids, such as compressors, power drills, motor saws, bulldozers, and large amounts of explosives, as well as means of transportation, both motor transport and pack trains.

67. TRAINING. In order to provide maximum assistance to the other arms, training of engineer troops in mountain operations should cover the following:

- a. Assault climbing.
- b. Mountain road construction, maintenance, and repair.
- c. Bridge construction using local materials.
- d. Rigging.
- e. Erection of tramways and cableways.
- f. Demolition.

68. ROAD CONSTRUCTION. a. Road construction plans in rugged mountains must often contemplate

initially only the improvement of trails built from existing paths. Later, these may be further improved to accommodate $\frac{1}{4}$ -ton trucks and, eventually, heavier trucks.

b. The construction of roads in mountainous terrain is one of the most important duties of an engineer unit. All roads built on slopes in such areas are usually of the cut-and-fill types. Roads will have to be built as the situation changes, rather than according to a fixed preconceived plan. Supply roads should, as far as possible, follow the contour lines. To avoid the silhouetting of men and vehicles, no roads should be built along the crests of ridges. Routes should be selected with special regard to cover and the speed with which the roads can be put into service. Routes should bypass marshy spots and localities which require excessive rock blasting and movement of large boulders.

c. On sidehills, all advantage should be taken of natural routes, to reduce the amount of cutting and cribbing to hold the road foundation. Trees may be cut for use as cribbing and should be trimmed of all branches, then placed on the downhill side of the road. The earth cut from the uphill side is dumped on the cribbing. The air compressor and bulldozer should be used to the greatest extent possible. The efficiency of the compressor decreases as the altitude increases. Special attention should be given to drainage, as spring thaws and heavy rains will wash out poorly constructed roads. The road beds on sidehills should be banked to the inside to reduce the cutting of ruts across the road by water. Such inward banking will also cause wheeled vehicles that skid in wet weather to slide into the bank rather than down the mountain side.

d. In mountains it may often be impossible to make

full use of normal engineer heavy equipment in road and bridge construction, execution of demolitions, and preparation of obstacles. In such cases, reliance must be placed upon hand labor and light equipment. It may often be necessary to add to the normal allotment of hand tools and to supplement or replace construction machinery by special light equipment. The type and quantity of such special equipment will vary with the situation, but can usually be determined by proper engineer reconnaissance.

e. Underground water gives considerable trouble to road builders. Localities where it is present should be prepared for drainage, either by placing a culvert across the road, or a heavy subcourse of large stones to allow underground drainage. This condition may also be counteracted by corduroying the road in that locality with timber poles or logs cut at the spot. Special attention will necessarily be given to snow removal during the winter months. This will entail the use of additional engineer troops, and bulldozers and snow plows. Maximum use must be made of crossing or bypassing expedients which require little material. Culverts, either prefabricated or built on the spot, and fills may often be substituted for bridges. For additional information, see FM 70-15.

69. BRIDGES. The construction of bridges is an essential operation of any engineer unit. Specifications for standard bridges may be found in FM 5-10. Special bridges and bridge expedients useful in mountain operations are described in the following subparagraphs.

a. Branches covered with snow. Branches are used for bridge expedients for snowshoe, ski, and foot

troops. Small crossings may be made by laying branches over or in shallow streams, then covering them with snow. This allows the soldier to go across without removing skis or snowshoes. Ice crossings may be reinforced by laying branches, straw, or grass on the ice, then flooding them with water and allowing them to freeze.

b. Floating expedients. Floating expedients, such as rafts, can be made from logs of sawed timber, such as chess from the ponton bridge, and rope lashings.

c. Rope crossing (fig. 1). A rope crossing or horizontal hauling line requires that an experienced mountain climber go ahead to establish the anchors on the opposite side of the crevasse or ravine to be crossed. A snap link attachment made to the hand rope from a rope around the waist of the man crossing may be used to provide additional security.

d. Rope footbridge (fig. 2). For the rope footbridge, a 1-inch rope is used for the walkway, and two 1/2-inch ropes for hand lines, which are attached to the 1-inch rope by means of short lashings. The tie used is the clove hitch. Trees and rocks can be used as anchors.

e. Improvised cableway (fig. 3). An improvised cableway may be constructed from steel cable or 1-inch rope. Trees or suitable boulders can be used as anchor points. Steel cable must be used for loads in excess of 500 pounds; 1-inch rope is adequate for lesser loads. (See TM 5-225.)

f. Swiss bridge. The Swiss bridge, single bent (fig. 4) or double bent (fig. 5) types, is used as a support bridge for infantry and pack animal units respectively. This type of bridge, used for crossing very swift, wide,

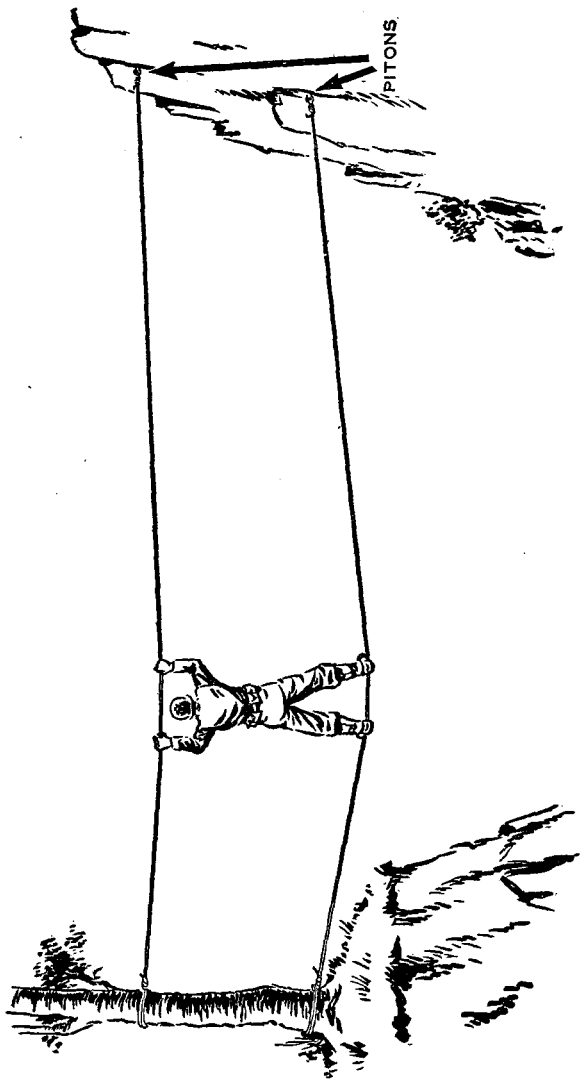

Figure 1. Rope crossing.

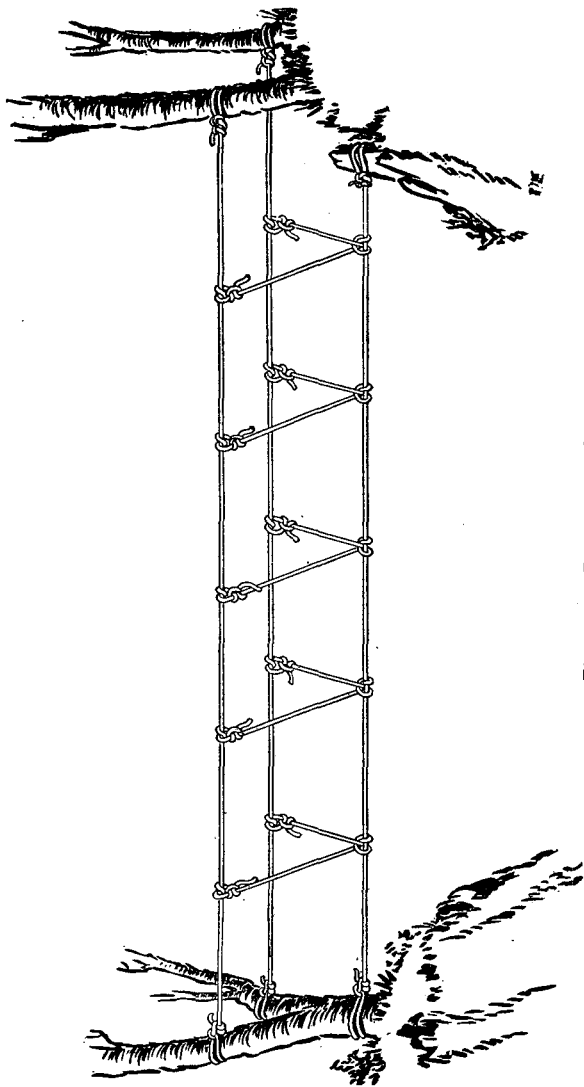

Figure 2. Rope footbridge.

shallow mountain streams, marsh, and swamp areas, can be constructed quickly from local materials or materials easily hand-carried along mountain trails. This bridge obviates the necessity of foot troops wetting their clothing and equipment in fords, a dangerous practice during

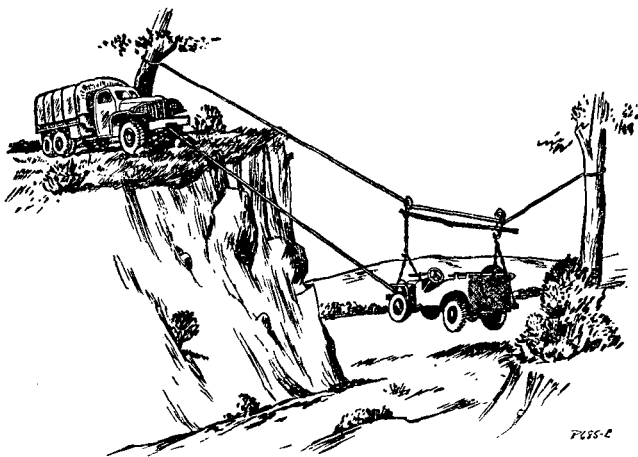

Figure 3. *Improvised cableway.*

cold weather, and also facilitates the movement of pack trains, as it is sometimes difficult to force animals through swift mountain streams.

(1) The bridge is constructed from natural timber spars, 3 or 4 inches in diameter and approximately 20 feet long. Short lengths of wire or rope, or vines, can be used as lashings, and planks or small round timbers as walkways.

(2) The construction crew consists of one platoon of combat engineers divided as follows: one squad as a cutting party, one squad as a carrying party, and one squad as an erecting party.

(3) The cutting party cuts timber 3 to 4 inches in diameter at the butt and ranging in length from 15 to 20 feet long. This party also trims the branches.

(4) The carrying party cuts spars to length and carries them to the bridge site. The timbers are cut in the

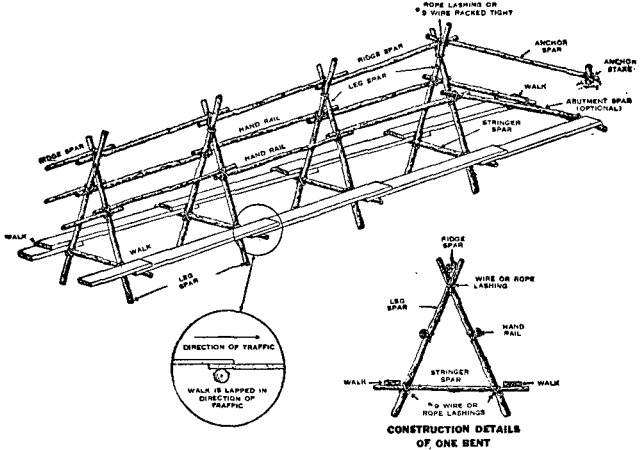

Figure 4. Single bent Swiss bridge.

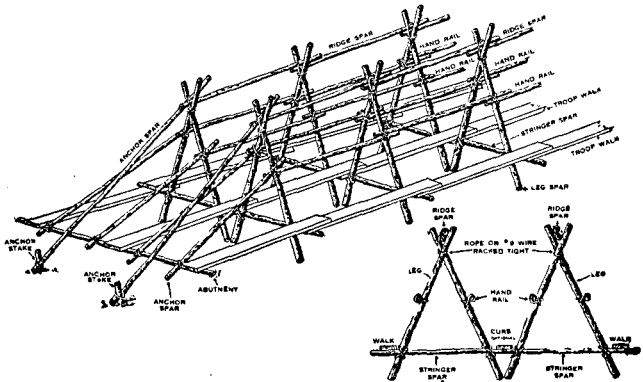

Figure 5. Double bent Swiss bridge.

following lengths, the number of pieces depending on the number of bents to be used.

Table I. Timber required for one bent of Swiss bridge.

	Number of timbers	Length (feet)	Nomenclature
Single bent bridge (foot troops only)	2	15	Leg spars
	1	10	Stringer spar
	1	20	Anchor spar (for end bent)
Double bent bridge (foot troops and pack animals)	4	15	Leg spars
	1	20	Stringer spar
	2	20	Anchor spar (for end bent)

(5) While the cutting party is obtaining the first spars, the erecting party cuts and sets the anchor stake (or stakes for double bent bridge) at the head of the bridge site on the nearside of the stream or crossing. The assembly section digs the trench for the abutment spar, if it is needed. The carrying section is assembling lashings and walks at the bridge site. To prepare the first bent, lash two leg spars together about $1\frac{1}{2}$ feet from the top with a shear lashing. After securing this lashing, separate the legs and, at a predetermined distance from the butt ends, space the stringer spar and lash the legs to it with square lashings. This bent is ready to be placed in position as the first transverse support of the bridge. A ridge spar and the anchor spar are then temporarily lashed to the top of the bent. Additional bents, to the number required, are prepared. The bents are spaced according to the length of the plank to be used as a walk, squared to the center line and raised. The ridge spars are lashed securely to the shear and the walkway is

then laid. The lashing of one end of the anchor spar at the top of the bent is secured; the opposite end is lashed to the anchor stake. Where two ridge spars overlap, no permanent lashing is placed until both are in position. The length of the plank is available for use as a walk. If no planks are available, round timbers may be substituted as a walkway. Rope is suitable for use as handrails.

(6) The double bent bridge will easily support a loaded pack animal on the center walkway. It will stand in deep and swift water without appreciable damming effects, since there are few spars which are in the stream to catch debris.

70. ENGINEER RECONNAISSANCE. Mountain engineer reconnaissance should precede all engineer operations, but not delay them. Small, dismantled reconnaissance details are best adapted for this task.

71. DEMOLITIONS. a. For most demolition work in the mountains, the principles of FM 5-25 are adequate. A few variations are found to apply in the case of hardwood trees and in some types of soil. Blasting a hardwood tree with an internal charge gives excellent results; for external blasting, the tree usually has to be overcharged.

b. For demolition in rocks and rock soil, normal procedure applies, except that fissures are often found which have to be well filled and tamped with earth. A fougasse made with rock and explosive can be very effective if used on routes of approach in valleys. It may be controlled, or set off by a booby trap device.

72. MINES. a. An attacking force must know in what areas antitank or antipersonnel mines are likely to be used, and be prepared to deal with them. Mechanical mine exploders are of little use in the mountains and there is as yet no substitute for the removal of mines by hand after they have been located by the employment of detectors, visual inspection, probing, or a combination of all of these methods.

b. In general, a defending force lays antitank mines mixed with antipersonnel mines in the comparatively narrow approaches to its position which are passable to tanks. On slopes not passable to tanks it employs chiefly antipersonnel mines, paying particular attention to logical approaches for foot troops. Laying of patterned mine fields is the exception, rather than the rule.

c. For details of mine laying and removal, see FM 5-31.

Section VIII. MEDICAL CORPS

73. PRINCIPLES OF OPERATION. a. The principles of operation which control the movements of troops in the mountains, as prescribed in FM 100-5, hold true for the medical service as well as for the infantry.

b. The principles set forth in FM 8-10 should be followed to the extent permitted by the situation, since central control, when practicable, is more efficient than decentralization. However, since the infantry adopts tactics based on the maneuverability of semi-independent small units, whether on the offense or defense, the conventional distribution of medical installations must usually be abandoned in mountain operations. The employment of the aid station, either as a completely centralized unit or divided, must be dictated by the tacti-

cal situation, the nature of the terrain, and the need for the elimination of all delays in the evacuation of mountain casualties.

74. REGIMENTAL AID STATIONS. The regimental aid station will usually follow the standard procedures of operation.

75. BATTALION AID STATION. The infantry battalion is usually decentralized in mountain operations to the extent that the centrally located battalion aid station is impractical. Under such conditions it may be necessary to divide the battalion medical section into company medical sections, each of which actively and closely supports its respective company on the march and in combat. This is especially true during enveloping movements where reinforced rifle companies are widely deployed to assault dominating ridges. The employment of these aid stations or company medical sections will be determined by the battalion surgeon.

76. COMPANY AID STATIONS. a. In mountainous terrain the adequate concealment and defilade usually found will enable the company medical section, when formed, to operate close to the front-line troops. It should normally be located close to the company command post. The following advantages are obtained by employing the above method:

(1) Relatively short litter hauls for the company litter team.

(2) Direct liaison between the front line and the rear medical establishments.

(3) Close contact with the infantry company com-

manders from whom changes in plans concerning the company may be quickly obtained.

(4) Increased rate of evacuation.

b. Since the company medical section installation will at all times be small, the casualties will be sorted, given only the necessary first-aid treatment and, if designated as evacuees, provided with shelter and warmth. Speed of evacuation must be stressed at all times.

c. When company medical sections are formed, it is desirable that the battalion medical section be able to provide three six-man litter squads. In each squad, one man should be designated as squad leader.

d. By adequate planning and reorganization, the regimental surgeon can so apportion the personnel in his command that various emergencies and situations encountered in mountain operations can be met. Additional personnel may be necessary. Assistance for medical personnel may be drawn from infantry reserve units, from driver personnel, when the use of vehicles is restricted or impossible, from collecting and clearing companies, and from corps troops.

77. COMPANY AID MEN. Company aid men must be familiar with the hazards of the cold and wind and proficient in the conservation of body heat and the construction of small wind-breaking installations and shelters.

78. COLLECTING COMPANY. **a.** In mountainous terrain, the difficulties of the collecting company of the division medical battalion are greatly increased since, instead of evacuating two or possibly three battalion aid stations, it may become necessary to maintain a chain of evacuation from six or more company medical sec-

tions. As a result, the collecting company may have to be split into two or three sections, each section supporting its respective battalion. These sections may be separated by ridges, thus requiring the independent operation of ambulance shuttles to a common basic relay post. This relay post may at times be the only central base of communication between the various sections. A centrally controlled collecting station should be instituted whenever possible, and the splitting of the collecting station into sections used only when the situation so demands.

b. Since the defilade is generally excellent in mountainous areas, the collecting station should be brought as far forward as possible. Division collecting points should be installed behind each of the company or battalion aid stations in order to operate with the greatest efficiency and to conserve the energy of the litter bearers. The collecting points should be so installed that they serve as warming stations where a casualty can be kept sheltered from the inclemencies of the weather, and be given supportive treatment until evacuated. Two medical men should be assigned to operate each collecting point.

c. The litter bearer haul should be reduced to an absolute minimum and vehicular transportation used wherever possible. Frequently it may be advantageous to assign additional litter bearers to the battalion medical section to clear the field more rapidly, and assign $\frac{1}{4}$ -ton trucks from the battalion section to the collecting company.

79. CLEARING COMPANY. The tactical problem of the clearing company in mountain operations is generally similar to that in flat terrain.

80. MARCH PROCEDURES. Before a march is started, the company medical sections, if formed, should join their respective companies and follow closely behind them, evacuating all casualties along the route of march to collecting posts that have been designated by the battalion surgeon and the collecting company commander. These points should be sheltered areas prominently marked to be recognized by the litter bearers or drivers of vehicles. Each collecting post should be under the supervision of two men from the collecting company. They should be assigned to a specific post and should join the column before the march begins. On reaching their post they take charge of all casualties, treat them, and rejoin their unit when the last casualty has been evacuated.

81. LIAISON. a. Adequate liaison does much to speed evacuation of the wounded, and is essential in the successful accomplishment of a medical mission. The qualifications of the men designated as contact agents should be a sense of responsibility, aggressiveness, and intelligence. They must be well trained in map reading and message writing, and should keep their commanding officer constantly informed regarding the developments on the front line.

b. Once established, communication between echelons must be kept intact. All available means of communication should be utilized to the maximum. The establishment of the company aid station close to the front line permits the medical officer or noncommissioned officer to obtain first-hand information as to the progress of the operation either by personal observation or by contact with the infantry company commander. Litter

bearers can serve as an important source of information. Messengers operating between medical installations and command posts make possible utilization of radio and telephone facilities.

82. EQUIPMENT. Operations in mountainous terrain require the medical personnel to carry additional items of equipment necessary for the evacuation of casualties, that is, ropes, pitons, and piton hammers. All unnecessary items of equipment or those for which substitutes can be improvised should be left behind. Heavy tentage, bulky chests, extra splint sets, excess litters and unnecessary medical supplies should be stored. The battalion surgeon should give due consideration to the equipment and supplies to be carried forward, and should make adequate plans for an equitable distribution of these items to the various company medical sections. Since the aid station installation is usually very small, only the bare necessities are carried on packboards. The trays of the medical chests are filled with vital medical supplies, and covered by three or four blankets. This makes a convenient load to be lashed to a packboard. Two men can easily carry the items of equipment and supplies necessary for the installation of a company aid station. If trays are not available, blanket rolls can be made of the supplies and they can be either lashed to packboards or carried in partially folded litters. In addition to the above, it is advisable to carry a few shelter halves and at least two hand axes in each aid station section. It may be necessary to pack-carry some equipment from the collecting station for the installation of collecting points.

83. SHELTER. Since the transportation of heavy

tentage is impracticable, shelter for casualties must be improvised in cold weather in order to prevent undue exposure to the weather with a resulting increase in the number of shock cases. In the summer, or in warm climates, such shelters may not be necessary. Satisfactory shelters can be built of a few saplings, some evergreen boughs, and available shelters halves or blankets. Caves, rock overhangs, clumps of thick bushes, ruins, fallen trees, and trenches covered by boughs will protect the casualty from the mountain wind and the cold. When casualties must be kept overnight, a better weather-proofed shelter should be constructed. Detailed information on shelters in cold weather operations may be found in FM 70-15.

Section IX. QUARTERMASTER CORPS

84. REFERENCES. For information on quartermaster service in the theater of operations, see FM 10-10; for information on supply of the infantry regiment, see FM 7-30.

85. GENERAL PRINCIPLES. a. Since the combat unit in mountain operations is usually a reinforced infantry battalion, with the resulting decentralization of command, there must be a corresponding decentralization of supply. The division quartermaster recommends the method of distributing supplies to the assistant chief of staff, G-4. Final determination of the method to be employed is made by the division commander, based on the G-4 estimate of the situation. Because of the special difficulties involved in supply during mountain opera-

tions, the division quartermaster may recommend the establishment of a division supply point. In certain cases, regimental supply points may be necessary for servicing isolated front-line battalions. The location of these supply points and the time that the various units will draw their supplies should either be incorporated in the field order or, in a rapidly changing situation, the information should be furnished in fragmentary form.

b. Labor for the handling of supplies at the division supply points is furnished by the quartermaster service elements of the division. Labor at unit distributing points is furnished by the units receiving the supplies.

c. It may often be necessary for the quartermaster to devise special combinations and methods of distribution. These will depend, to a large measure, on transportation facilities, location of combat units, and type of terrain in which operations are under way.

d. Supply operations in mountainous terrain are affected by the following additional factors:

(1) Local resources are usually poor.

(2) Ration needs of the troops and animals are increased by the rigors of the terrain and, in cold weather, by the climate.

(3) The needs for equipment and fuel are increased in cold weather.

e. Careful planning by all echelons of command is of the utmost necessity if supply is to function smoothly. Unless plans are carefully made, the rapidly changing tactical situation will cause a lengthening of supply lines which may result in a retardation of supply, or even its interruption. To prevent such occurrences, plans should be made to organize advance supply points for each tactical unit being serviced.

CHAPTER 4

CONDITIONING AND ACCLIMATIZATION

Section I. GENERAL

86. NECESSITY FOR CONDITIONING AND ACCLIMATIZATION. a. The training of soldiers in mountains of low or medium elevations does not require any special conditioning or acclimatization, since the occurrence of altitude sickness with its chain of incapacitating symptoms is extremely rare.

b. There is a need, however, for a conditioning and acclimatization period of 10 to 14 days for troops to be trained in altitudes of 8,000 feet or more. After a week or two at high altitude, the average soldier will find that he is less exhausted, his headache is gone, he sleeps better and his appetite is normal, and as days pass he will find that life in the mountains is definitely exhilarating. The essential reason for this change is that the number of red blood cells in his blood have increased, enabling more oxygen to be carried from his lungs to the tissues of his body. During this period of acclimatization the training program should provide for graduated physical exercises, including short marches, together with appropriate rest periods. In high mountains, it is generally found that the air is dry and as a result perspi-

ration is more quickly evaporated. This tends to mislead a person into thinking that he is not perspiring freely due to the fact that his clothes are less frequently moist even after strenuous exertion. This loss of fluid plus the loss of salt through perspiration soon leads to acute fatigue, associated with muscle cramps and heat exhaustion, unless adequate precautions toward their replacement are taken. The proper maintenance of the water and salt balance is imperative in the mountains.

87. PSYCHOLOGICAL ADJUSTMENT. The psychological adjustment of the individual must be considered. Many persons who have lived at low altitudes (sea level or slightly higher) all their lives may have preconceived notions about the supposedly harmful effects of high altitude on the human organism. To them any abnormal complaint, however trivial, may be construed as an ill effect of altitude, as a result of which they may become unduly concerned about their physical condition. This can be prevented by an active educational campaign in which it is shown that high altitudes do not have the supposedly harmful effects. Frequently men recently transported from a flat terrain cannot approach steep slopes or cliffs without inner qualms and without a sense of insecurity. They must be slowly introduced to them and their confidence progressively developed until they can negotiate a passage across such obstacles with assurance and ease. Men must be taught the various handholds and footholds used, be indoctrinated with the principles of mountain marching, and become familiar with the pitfalls to be avoided. These capabilities are attained only through constant training and application. There are many individuals who pos-

sess fear of height in varying degrees. It can be overcome only by familiarity through practice.

88. PHYSICAL CONDITIONING. Regardless of previous army training, and of the amount of flat cross-country marching practiced, the soldier newly initiated into the mountains finds mountain marching arduous and tiring. A new group of muscles is called into play, and these muscles must be developed and hardened. Furthermore, a new technique of moving rhythmically must be learned. This conditioning is attained only through daily marches and climbs which result in increased stamina and endurance. Simultaneously with this development, men acquire increasing self-confidence in their ability safely to negotiate terrain which previously they considered impassable.

Section II. PERSONAL HYGIENE

89. PRINCIPLES. The principles of personal hygiene and sanitation that govern the operations of troops in the lowlands are applicable in the mountains as well, and the same strict adherence to the policies prescribed in FM 8-40 and 21-10 must be enforced. Alpine territory is relatively germ-free; however, low mountain areas come in the same category as lowlands as far as sanitary policies are concerned.

90. WATER DISCIPLINE. Strict control must be exercised over all sources of water supply. Troops must realize that the general concept that mountain water is safe for consumption is a fallacy. Water discipline must be emphasized, since the water demand of an individual

in the mountains is great and, unless closely controlled, he may drink polluted water. Fluids are lost through respiration, perspiration, and urination; and this loss must be replaced if the soldier is to operate with normal efficiency.

91. WASTE DISPOSAL. In mountainous terrain without snow, disposal of human and kitchen waste products should follow the normal methods. For methods which may be used under conditions of snow and extreme cold, see FM 70-15.

92. PERSONAL HABITS. a. Under extreme conditions of cold, there is a general tendency for the individual soldier to permit himself to become constipated in order to avoid the inconvenience and discomfort of straddling a latrine trench. This neglect should be discouraged by all officers and noncommissioned officers of the unit, since it ultimately induces a great prevalence of illness among the troops. The soldier must be educated in the consequences which may result from poor personal habits. This is a command function. Whenever possible, heated latrines should be provided.

b. Personal cleanliness is especially important in extreme cold. In freezing temperatures, the individual has a tendency to neglect washing due both to the cold and the scarcity of water. This may result in skin infections and vermin infestation. If bathing is impossible for any extended length of time, the soldier should at least examine his skin and stimulate and cleanse it as much as possible by briskly rubbing his body with a rough towel. In this way, the occurrence of skin infections may be kept to a minimum.

c. Particular attention must be devoted to the care of the feet, in order to protect against trench foot and frost-bite. The causative conditions for one or the other of these disturbances are prevalent throughout the entire year in high mountains. The feet should be kept dry and socks and insoles changed at least once daily. The principles of foot hygiene apply with greater force in high mountains than they do in any other terrain.

Section III. MALADIES

93. MOUNTAIN SICKNESS. Mountain, or altitude, sickness is an acute temporary illness occurring in mountains. The novice and experienced climber alike are subject to this malady in altitudes as low as 4,000 to 5,000 feet. The cause is usually poor physical condition; lack of acclimatization, or both. Symptoms may be headache, nausea, vomiting, lack of appetite, insomnia, and irritability. This condition can be relieved by rest. In rare cases the patient must be taken to a lower altitude.

94. VALLEY DISEASE. Valley disease occurs when an individual acclimatized to high altitude returns to the low altitudes. It is the opposite of mountain sickness. While in the mountains there is an abnormal increase in the number of red cells to augment the oxygen-carrying power of the blood, this increased power is not needed at sea level and the body literally has too much blood. The resulting symptoms are lassitude, increased sweating, weight loss, headache, noises in the ears, indigestion, irritability, depression, forgetfulness, and neuralgialike pain. One or more of these symptoms

may be present at the same time. Depending on the individual, they disappear within a few days to a few weeks.

95. GLACIER LASSITUDE. Glacier lassitude or snow field lassitude is a transitory condition which often assails climbers on hot days. Physical factors which produce this indisposition are hollows into which the sun beats directly, reflected light, and stagnant or excessively still air. The physiological factors which produce this feeling of weakness are probably due to a disturbance of the circulation. The cure is to get into an area where there are moving air currents.

Section IV. CLIMATE

96. GENERAL. Mountain climate has a very definite effect on the physiology and pathology of the individual because the human organism is sensitive to weather changes and differing climates.

97. MOUNTAIN AIR. a. Mountain air is relatively pure. The higher one goes, the more nearly pure it becomes. Above 5,000 feet it is practically germ-free. The physical composition of the atmospheric air is practically the same at high altitudes as it is at sea level. The apparent rarefaction of air at high altitudes is due to the decreased partial pressure of the atmospheric oxygen. The utilization of oxygen by the body is dependent upon the pressure under which it is forced into the tissues. Ultraviolet rays of high altitudes partially convert oxygen into ozone, a gas which kills germs. Forests, especially those with coniferous trees, lessen the per-

centage of carbon dioxide, and thus do their part in purifying the air. The snow completes this purification by drawing out of the air, and holding, all the impurities which might still be able to contaminate the air.

b. High mountain air is dry, especially in the winter when the humidity in the air condenses into ice. This dryness increases with the altitude. The amount of water vapor in the air decreases in geometric proportion as the altitude increases.

c. Atmospheric pressure drops as the altitude increases. The pressure varies, on the average, about $\frac{3}{8}$ inch for every 330 feet rise.

d. The temperature drops as the air becomes more rarefied. In an atmosphere containing a considerable amount of water vapor, temperature drops about 1° F., for every 360 feet of rise in altitude. In very dry air it drops about 1° for every 180 feet.

e. An important characteristic of the atmosphere at high altitudes is its luminosity. The sun's rays are neither absorbed nor reflected by the atmospheric haze which fills the air of flat country, especially in cities. The rare dry air of the mountains allows the visible rays of the solar spectrum to pass in their entirety. In addition, a fraction of the invisible rays, among which are the ultraviolet rays, also penetrates the haze. In pure atmosphere, the proportion of ultraviolet rays remains constant, regardless of the altitude.

CHAPTER 5

MILITARY ROCK-CLIMBING

Section I. GENERAL

98. IMPORTANCE. Military rock-climbing provides a means for operating on rugged mountainous terrain or shores. In such terrain there are two adversaries—the enemy and, often more of a foe, the mountain. Specialized men and equipment must be used to combat the mountain successfully.

99. HOW IT IS USED. Soldiers skilled in military rock-climbing can perform many essential missions in rugged country. They can serve as guides, rock engineers, observers, snipers, scouts, patrol members, and assault team members.

100. EFFECT ON DEPLOYMENT. An estimate of friendly or enemy capabilities in rugged terrain is possible only if the higher commanders are thoroughly familiar with the capabilities of the rock-climber. All officers who are to operate in mountainous terrain must be oriented in this respect. As many officers as possible, and at least one per company, should become expert climbers.

101. TRAINING REQUIREMENTS. a. Specialists. Units preparing for operations in mountainous terrain should have climbing specialists in each unit down to and including the company. They will usually function as teams of two men. The men must have reasonable athletic ability, normal resourcefulness, mental toughness a little higher than normal, and no great fear of height. Prospective climbing experts should be selected with care.

b. Semitrained climbers. Preparation for mountain operations is not complete until the unit commander knows how all his men will react to exposure to height and to the out-of-the-ordinary muscular effort. A few hours' climbing for all men provides a valuable index to each man's future reaction to combat. Each man is exposed to unknown, and therefore frightening, danger. Fear of falling is a basic instinct, and may be as hard to fend as fear of enemy fire. Analysis of the man's reaction will enable the commander to place those who will be stopped by fear of either fire or falling in a position where they will not jeopardize safety of the unit. Special training aids for troops are described in section IX.

Section II. BASIC TECHNIQUE

102. MOUNTAIN WALKING. Mountain walking is similar to walking in any rough country. The long swinging stride can seldom be used, as the feet must be lifted to clear obstructions or swung around them. The lift or rise of each step should be kept as low as possible to avoid unnecessary fatigue. The sole of the

foot should be placed flat on the ground to distribute the weight as widely as possible and to obtain a better purchase. The weight should be directly over the feet on level walking, but in descending a forward lean to bring the body more nearly perpendicular to the slope will increase speed and relieve some of the shock to the knees and spine. In ascending it is necessary to avoid the impulse to lean in toward the slope. The walker should use a steady rhythmic motion. On steep slopes a zig-zag course is less fatiguing than a straight upward climb. Details of march technique are discussed in paragraph 8.

103. BALANCE CLIMBING. a. Definition. Balance climbing is the type of movement used to travel on steep slopes. It is a combination of the balanced movement of a tight-rope walker and the unbalanced climbing of a man ascending a tree or ladder.

b. Body position. The soldier must climb with his body in balance, which means that his weight should be in poise over his feet or just ahead of them as he moves. (See fig. 6.) His feet, not his hands, carry his weight,

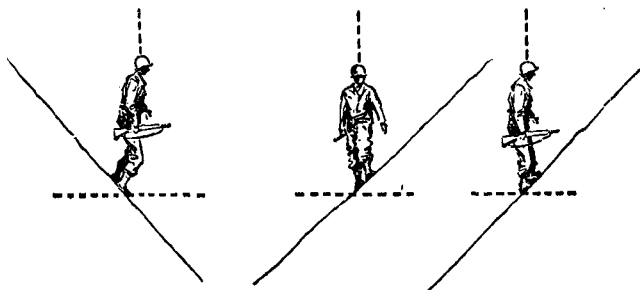

Figure 6. Correct body position in relation to angle of slope.

except on the steepest cliffs. His hands are for balance. Feet will not hold well when the climber leans in toward the rock. With his body in balance the climber moves with a rhythmic slow motion. He uses three points of support (two feet and one hand, for example) whenever possible, and prefers handholds that are waist to shoulder high. He relaxes, because tensed muscles tire quickly; when he rests, it is with his arms low, where circulation is not impaired. He uses small intermediate holds rather than stretching and clinging between widely separated big holds. He avoids the spread-eagle position, in which a man stretches so far he cannot let go. He climbs sideways to the rock where he can, rather than hug it too closely. In descents he faces out where the going is easy, sidewise where it is hard, and faces in where it is difficult (fig. 7); he uses the lowest possible handholds.

c. Types of holds. (1) *Pull holds* (fig. 8) are those that are pulled down upon and are the easiest holds to use. They are also the most likely to break out.

(2) *Push holds* are pushed down upon, help the climber keep his arms desirably low, rarely break out, but are more difficult to hold to in case of slip. A push hold is often used to advantage in combination with a pull hold.

(3) *Friction holds* (fig. 9) are those dependent solely on the friction of hands or feet against a smooth surface. They are difficult to use because they give a feeling of insecurity, which the climber tends to try to correct by leaning closer to the rock, thereby only increasing his insecurity. They often serve well as intermediate holds, some of which will give needed support while the climber moves over them, but would not hold him were he to stop.

(4) *Cross-pressure* holds are holds that do not exist as useful single holds, but must be used in combinations by exerting cross pressure between hands, arms, and legs. There are several types:

(a) The pinch hold, attained by pinching a protruding part between the fingers.

(b) Pressing outward (fig. 10) or pulling inward with the arms.

(c) The lie-back (fig. 11), leaning to one side of an offset crack, with the hands pulling and the feet pushing against the offset side.



Figure 7. *Descending traverse.*

(d) Inverted pull (fig. 12) or push holds, sometimes called underholds, permitting cross pressure between hands and feet.

(e) Chimney climbing (fig. 13) where cross pressure is exerted between the back and the feet or hands or knees.

(5) *Footholds* (fig. 14). The service shoe with rubber sole will hold on slabs up to about 45° . On such steep slopes the body should be kept vertical, with use being made of small irregularities in the slope to aid friction. Footholds less than $\frac{1}{2}$ inch wide can be sufficient for intermediate holds, even when they slope out.



Figure 8. Pull hold.

(6) *Shoulder stand* (fig. 15). The shoulder stand, or human ladder, is used to overcome a holdless lower section of a pitch, to reach the easier climbing above.

d. Use of holds. A hold need not be large to be good, nor need it be solid, so long as the pressure is in the direction that holds it to the mountain. Experienced



Figure 9. Friction holds.

climbers use holds which are so small that they can scarcely be seen. The climber must roll over his holds, not try to skip or jump from one to another. It is, however, often desirable in traverses to use the hop step, in which the climber changes feet on a small hold, replacing his outside foot with his inside foot so that he may move sideways more easily. A slight upward hop followed by precise foot work accomplish this useful step.

e. Margin of safety. (1) A margin of safety is the protective buffer a climber keeps between what he knows to be the limit of his ability and what he actually tries to climb.



Figure 10. Cross-pressure hold—pressing out with arms (open chimney).

(2) The climber bases his margin of safety on experience gained with little or no risk in training, where he learns to calculate his ability. This he learns by climbing close to the ground, or tied to a rope held or paid out by a trained man above. He climbs first on the easy and obvious holds, next on the more difficult ones, and finally on difficult pitches until he reaches the limit of his ability. When climbing thereafter he leaves a margin, which can be progressively smaller as he learns to calculate better.

(3) The margin of safety should be calculated not only for the pitch immediately ahead but for the entire



Figure 11. Cross-pressure hold—lie-back.

climb. The climber should plan his route and movement far enough ahead so that he never finds himself in difficulties beyond his ability.

104. ROPES AND KNOTS. a. Purpose. Much of the climbing in military operations may be free climbing; that is, without rope. However, on some steep unbroken cliffs, where exposure is great, the rope is necessary in party climbing. Fixed ropes and other aids may be needed as well.



Figure 12. Inverted pull hold.

b. Care of rope. When rope is needed it is the climber's lifeline, and it should be cared for accordingly. When not in use, the rope should always be coiled in an approved manner. It should never be stepped on. For long carries, it may be carried either over the neck and one shoulder in a diagonal chest carry, or twisted into a figure-8 and folded over in the pack.

c. Inspection of rope. The climber cannot always know that the rope he is to use has been properly cared



Figure 13. Cross-pressure hold—chimney technique.

for. He should therefore inspect it carefully before putting it to any demanding use, particularly if a man's life is likely to depend on it. For exacting use, rope should be new or nearly new, resilient, and free of serious cuts or abrasions.

d. Knots for the climber (figs. 16 and 17). (1) The *bowline* knot is used for either end man on a rope, or for the preliminary tie on the belay point of a fixed rope. This is one of the easiest knots to untie after it has held a heavy load.

(2) The *bowline on a coil* is used to take up extra rope around the climber's body to relieve strain around the waist in tension climbing and in the event of a fall, and is used by the faller in practice belaying.

(3) The *butterfly knot* is used in tying men in to the middle of a rope. This knot reduces the strength of the rope less than do other knots.

(4) The *square knot* is used in tying two equal-diameter ropes together. Make half hitches on each side with the loose ends.

(5) The *fisherman's knot* is used in tying together two ropes of unequal diameter.

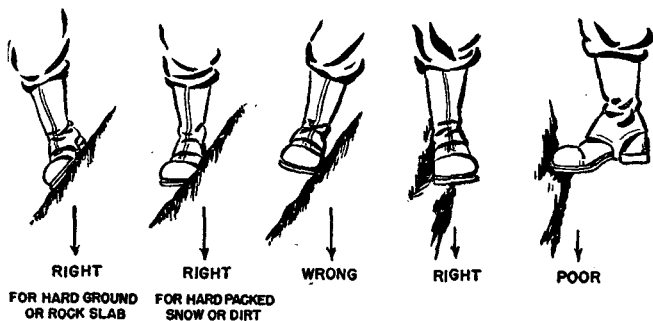

Figure 14. Footholds.

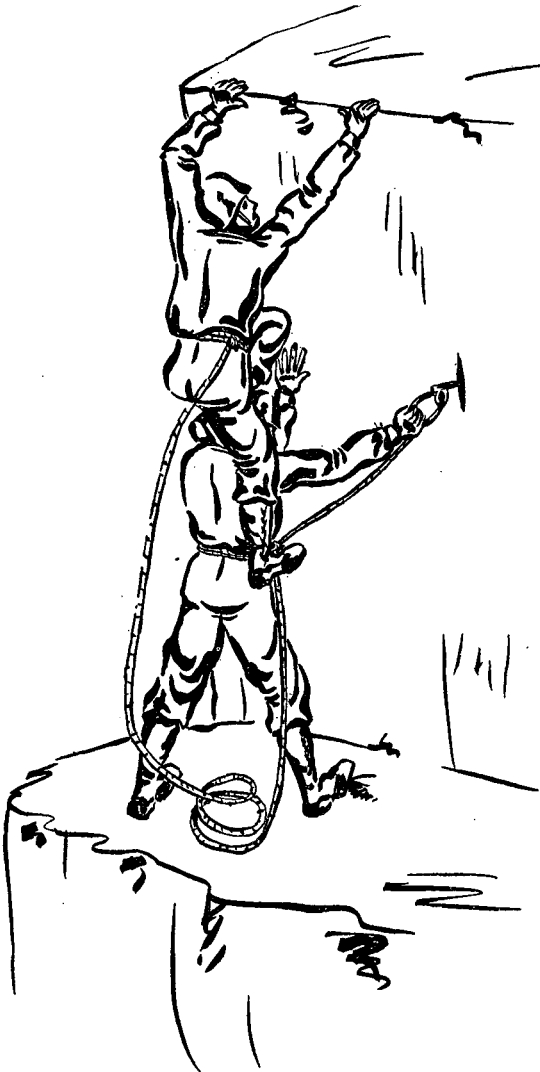
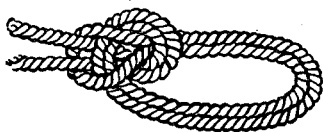

Figure 15. Shoulder stand.



BOWLINE ON A BIGHT



BUTTERFLY

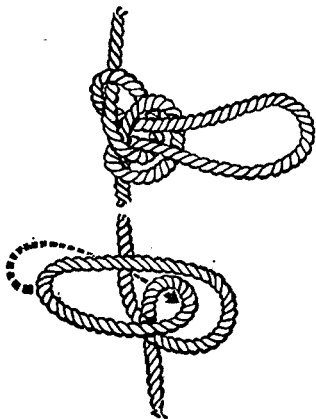

BOWLINE



FISHERMANS KNOT

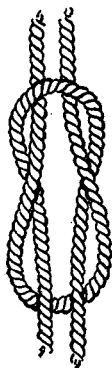

SQUARE KNOT

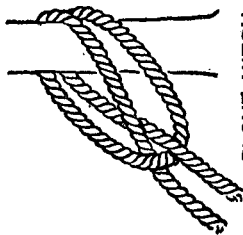

CLOVE HITCH

Figure 16. Types of knots.

(6) The *slip knot* is used for tying in fixed ropes, and for anchoring the belayer.

(7) The *Prusik knot* is one which will hold under stress, and slide when the stress is removed. It may be tied with a loop or on a bight. Its ratchet effect has many uses, described separately in succeeding paragraphs.

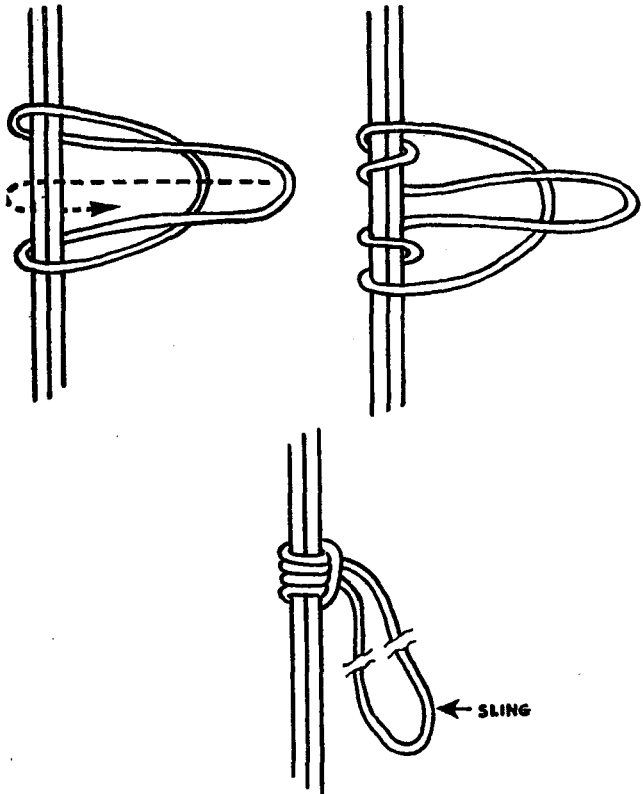

Figure 17. Prusik knot.

105. PITONS, SNAPLINK, AND HAMMER (fig. 18). **a. Purpose.** In conjunction with roped climbing, pitons are driven into cracks in the rock to provide—

(1) A secure point on the cliff to which the rope may be hooked by means of a snaplink. If the leading climber falls, he may then be held, pulley-wise, by a man below him. Successive pitons are driven as the climber moves upward.

(2) Secure points along the course of a fixed rope (par. 114) so that it will give greater support to troops using the rope.

(3) Anchor points for hauling lines. (See par. 115.)

b. Types of pitons. There are four types of pitons for rock, of which horizontals are most frequently used, verticals least, in a ratio of about 5 to 1:

(1) *Vertical* for cracks with flush sides, preferably vertical.

(2) *Horizontal* for flush or offset cracks, horizontal or vertical.

(3) *Angle* for wide, deep cracks, offset or flush, horizontal or vertical.

(4) *Wafer* for cracks that are thin, shallow, and flush or with flared opening.

c. Placing of pitons (fig. 19). Pitons are placed to reinforce the climber's judgment. If well placed and tested they will limit his fall to twice the distance he is above the piton plus the amount of slack the belayer lets run. In placing pitons the climber should—

(1) *Study the rock* to see that driving of a piton will not weaken it. Test rock for soundness by tapping with hammer. Select a crack that is wide enough to take $\frac{1}{3}$ to $\frac{1}{2}$ the piton shaft before hammering. Select the right piton—one that the rock will support best and that

the snaplink can be hooked into after the piton is driven in.

(2) *Drive the piton.* While driving watch the rock to see that it is not being weakened by further cracking. Watch the piton to see that it goes in smoothly and to notice if the point hits a dead end. Listen to the piton's sound at each blow; good verticals and horizontals usually go in with a rising pitch; wafers and angles will have no noticeable pitch so long as the ring is swinging free. Drive the piton hard, until the head begins to change shape. The greater the resistance overcome in driving the piton, the firmer it will be. A well-driven piton will withstand a direct outward pull of 1,000 to 2,000 pounds.

(3) *Test the piton.* Pull up several feet of slack, snap rope into snaplink, grasp doubled rope at least 2 feet from the snaplink. Jerk vigorously outward, downward, and to each side, observing the piton meanwhile, repeating if the test is questionable. Tap the piton. If the pitch has changed much, drive the piton in as far as possible; if the sound regains its original pitch the piton is good. If not, the crack has been enlarged and the piton should be treated with suspicion. This test alone should not be relied upon if the piton does not look good.

d. Snaplink. This is used to facilitate fastening the rope to the piton, and will hold a load of 2,000 pounds. In snapping into a piton, the climber should see that the snaplink will not cause unnecessary friction as he climbs beyond it, and that the gate is not likely to open accidentally owing to pressure against rock, rope, or piton.

e. Hammer. The point is for chipping rock or ice and cleaning out piton cracks, and not for pulling out

pitons, for the rest of the hammer is too lightly constructed to stand the stress.

f. Secondhand pitons. Pitons that have been used, removed, bent, and straightened should be treated with suspicion. In training areas pitons already in place should seldom be trusted, inasmuch as weathering will

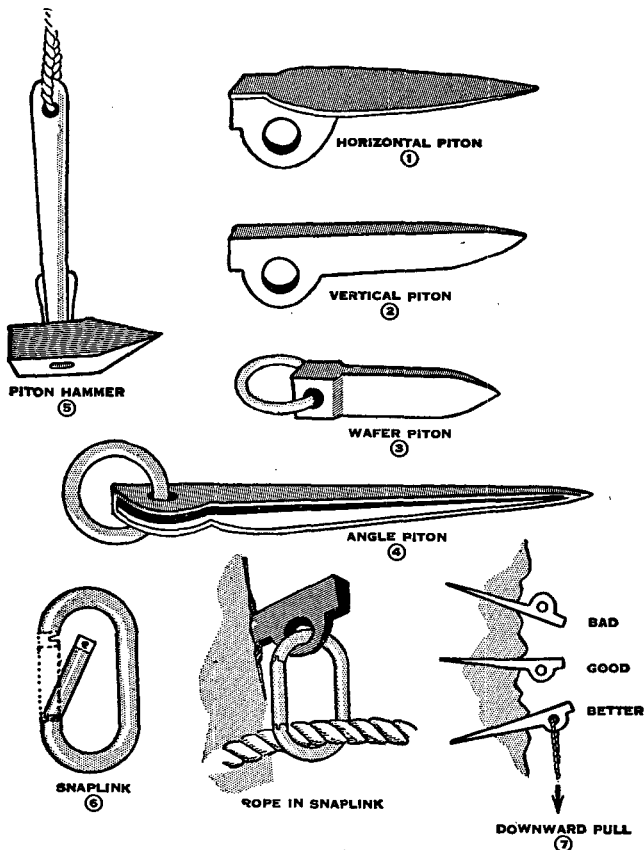

Figure 18. Climbing aids.

loosen them in time, and only the man who has just driven a piton has an adequate knowledge of how good it is.

106. BELAYS. a. **Purpose.** In party climbing two or three men are tied in to a 120-foot length of rope. Belaying provides the necessary safety factor or tension, enabling the leader to climb. Without belaying skill,

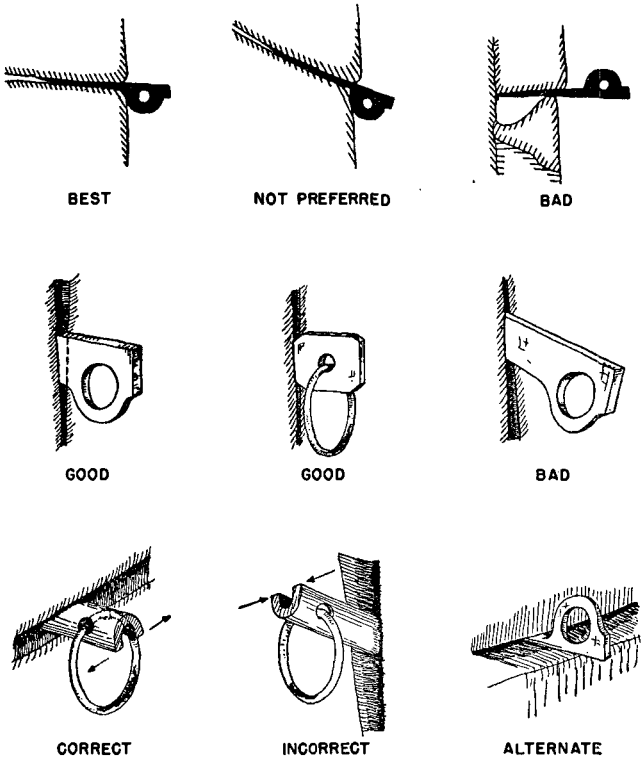

Figure 19. Placing of pitons.

the use of rope in party climbing is a hazard, not a help. When any one man is climbing, he is belayed from above or below by another man, who may use any one of several belay positions.

b. Procedure for all positions. The belayer must perform the following duties:

(1) Run the rope from the climber through his feeling hand (figs. 20, 21, and 22) around the hips to his key hand, and make certain it will slide readily.

(2) Anchor himself to the rock with a portion of the climbing rope if his position is doubtful.

(3) Be ready to move the key hand close in front of the body so that body friction will be enough to help check the rope in a fall.

(4) Make sure remainder of rope is so laid out as to run freely through the key hand.

(5) See that rope does not run over sharp edges or rock.

(6) Avoid letting too much slack develop in the rope through constant use of the feeling hand, except where this hand is used as an anchor. Gently tug the line running to the climber, thus sensing his movement. Avoid taking up slack too suddenly, as this may throw the climber off balance.

(7) Brace well for the final direction of a fall, so that the force of the fall will, wherever possible, pull the belay man more firmly into position. The climber should neither trust nor assume a belay position which he has not tried with some falls of a few feet in practice.

(8) Where necessary, seek a belay position that offers cover and concealment.

(9) Be able, in case of fall, to perform the following movements automatically:

(a) Relax feeling hand and move key hand in toward body for friction.

(b) Let the rope slide enough so that braking action is applied gradually.

(c) Hold belay position, even if this means letting the rope slide several feet.

c. Sitting belay (fig. 20). This is the preferred position when pitons are not in use. Belayer should attempt to get good triangular bracing between his two legs and buttocks. Wherever possible, legs should be straight. The rope should run around the hips at belt level or lower and be above anchoring rope, and key and feeling hands should be held inside of the thighs. If the belay spot chosen is back from the cliff edge, friction of rope over rock will be greater, and will simplify holding of falls, but the direction of the pull on the belayer will be directly outward. If the belay spot chosen is at the very cliff edge, friction will be much lower, but a fall will pull the belayer directly down into his position. Such a spot will require the belayer to hang his feet over the edge, and will not be taken unless the sitting position slopes back and down into the cliff.

d. Standing belay (fig. 21). This is the weakest military belay position, and is used only where it is not possible to use the sitting belay. An anchor is almost always essential.

e. Piton belay (fig. 22). As soon as the leader has placed a reliable piton, the direction of pull when he falls will be forward and up. The belayer should have a low anchor directly in line with this direction of pull, and should run the belay rope just below his buttocks. Both knees should be bent, to prevent the

rope from sliding up above the buttocks. The key arm should be extended; when a fall occurs, the arm is brought in, with steadily increasing resistance, to a position in front of the hip where as much rope as necessary is then allowed to slide through the hand. A fall is easier to hold by a piton belay than by a sitting or standing belay, especially if there are several pitons in place, because of the added friction between rope, rock, and snaplink. For this reason it is essential that the belayer keep enough slack in the line to prevent the fall from jerking to a stop; likewise, he must not resist the fall too much when its impact first hits him.

f. Tension belay (fig. 23). This is used when the leader, having placed a piton, wishes to lean back on his belay rope, either to rest or to drive in a higher



Figure 20. Sitting hip belay.

piton. The piton belay position is used, except that the belayer, to support the leader, sits back into the rope and brings his key hand close into his body to provide all possible friction. A Prusik knot, tied with a separate loop, placed by the feeling hand and run back to the anchor, will serve to hold the leader and free the belayer momentarily. The feeling hand can slide the Prusik knot along the belay rope as rope is paid out; it will hold when a direct pull comes on the knot. It



Figure 21. Standing hip belay.

should therefore not be on the rope if a heavy fall is expected.

g. Rock or tree belay. Where possible, the leader passes his rope behind rock projections or trees, which can serve the same protective purpose as pitons. He should avoid passing the rope over sharp edges, or crevices where the rope could jam or cause too much friction as he climbs beyond. When a rock or tree belay has been definitely established, the belayer should assume the piton-belay position.

h. Anchors. Experience in knowing what test a good belay position will withstand will indicate to the

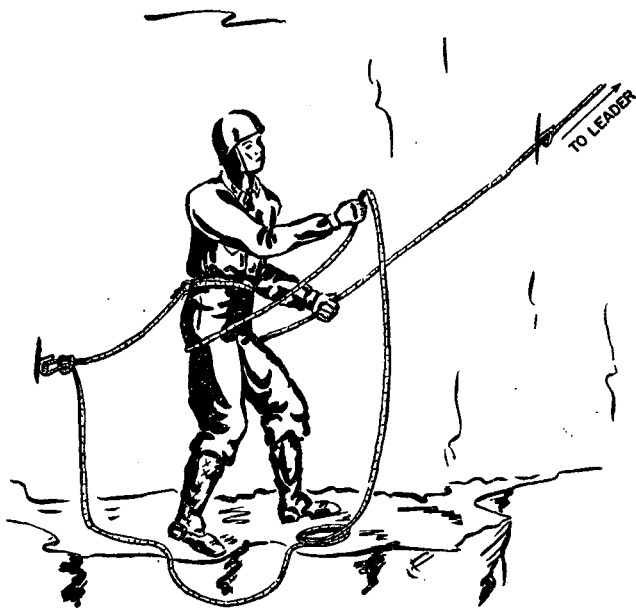

Figure 22. Piton belay.

belayer when he should take time to anchor, and when he need not. Until he has that experience, the belayer should anchor each position, either to a rock, piton, or tree, and should ordinarily use two half hitches on a bight around the anchor. Small bushes may serve well if the anchor rope is passed completely around the base. The anchor should be tied with a portion of the climbing rope next to the belayer, and should be tied snugly

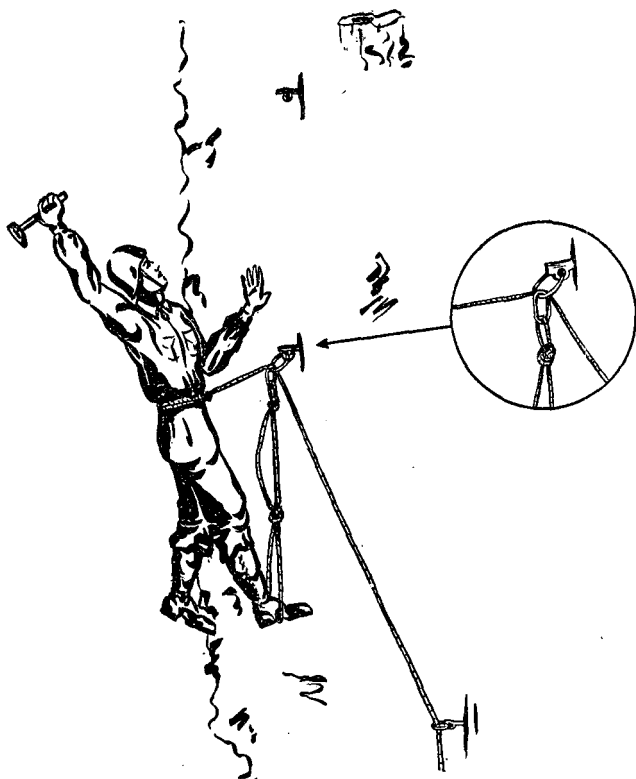

Figure 23. Tension belay.

enough to keep the belayer in position and not allow him to be jerked against the anchor in case of fall. Given a choice between anchoring to a rock point or belaying around it, the belayer should prefer the anchor.

107. RAPPELS. a. Purpose. The climber with a rope can descend quickly by means of a rappel—sliding down a rope which has been doubled around such rappel points as a tree, projecting rock, or two firm pitons tied together. Several techniques may be used.

b. Establishing a rappel. (1) In selecting the route, the climber should be sure the rope reaches the bottom or a place from which further rappels will reach the bottom.

(2) The rappel point should be tested carefully, and inspected to see that the rope will run around it when one end is pulled from below.

(3) If a sling rope must be used for a rappel point, it should be tied double.

(4) The first man down should—

(a) Choose a smooth route for the rope, free of sharp rocks.

(b) Place loose rocks, which the rope might later dislodge, far enough back on ledges to be out of the way.

(c) Prevent the doubled rope from twisting together by placing the index finger of the braking hand between the two ropes.

(d) See that the rope will run freely around the rappel point when pulled from below.

(5) Each man down signal “Off rappel” by pulling alternately on each end of the rope, so that the rope runs across the rappel point. This will be barely audible

at night, and will also assure retrieving of the rope after everyone is down.

(6) When the last man is down, the rope is recovered. The climber should pull it smoothly, to prevent the rising end from whipping around the down-moving rope, and he should stand clear of falling rope and the rocks which may be dislodged by it.

c. The body rappel (fig. 24(1)). The climber should face the rappel point and straddle the doubled rope. From the rappel point the rope goes between the legs, under the left buttock, up and over the left hip, across in front of the chest, over the right shoulder, and across the back to the left, or braking hand. The right hand grasps the rope running to the rappel point at about shoulder height. It is used only to steady the body and hold it in the desired position. Trying to support the weight with the right hand will result in a rope burn. The left hand can be held to the rear wherever comfortable, so long as the arm is nearly straight. Friction can be increased by moving the hand forward, and reduced by moving it backward. Control of speed will be learned more easily, however, if the hand itself is used as a brake. The climber then leans away from the rock just far enough for the feet to hold, with weight of the body supported by the rope, and descends slowly, leading with the left leg to make certain that the rope stays in place. The climber soon learns to rappel in longer and longer bounds, and to use insulation against heat on the shoulder and under the buttock.

d. The hasty rappel (fig. 24(2)). The rope from the rappel point passes between the legs, under the left buttock, up, and in front of the left hip, where it is held by the left, or braking hand. The right hand is used as

in the body rappel. On gentle slopes and short (25 feet or less) pitches the hasty rappel is superior to other methods. It is easier to assume and remove, and the climber will have less difficulty getting the rope to run if it is wet or if the slope is gentle.

e. The seat rappel. (1) *Shoulder method* (fig. 24(3)). Tie 10 feet of $\frac{1}{4}$ -inch rope into a sling, pass the doubled sling behind the body below the hips, place bight of each end in snaplink in front, and bring one strand of doubled rope forward between legs and snap it in. Rope from the rappel point passes up through



① *Body rappel.*
Figure 24. Rappels.

the same snaplink, over the right shoulder and back to the left hand. This method is cooler than the body rappel, except at the shoulder, and is faster. It is safer for men with heavy packs. However, it requires more time for preparation.

(2) *Hip method.* The $\frac{1}{4}$ -inch sling loop is coiled into a double loop, twisted into a figure-8 (with a complete twist at the junction) which is put on in the same manner as a supporter. The strands of a sling that pass



② *Hasty rappel.*
Fig. 24—Continued.

in front of the legs are all snapped into a snaplink. From the rappel point the rope passes up through the snaplink, around the right hip, behind the back (just below belt level) and around the left hip to the left (braking) hand. Weight is placed on the rope. The snaplink gate should now be to the left, its hinge toward the body. This method is as fast as the shoulder method, but concentrates the heat where it is easier to insulate against it.

f. Function of rappelling. Combat application of rappelling is not likely to be frequent; but when rappelling is necessary, speed, which requires practice, is



③ *Seat rappel.*
Fig. 24—Continued.

important. Rappelling provides one of the best means by which the novice can overcome fear of height and become confident on steep slopes. When rappels are used frequently, repeated and frequent checks of the rope must be made. Bad cuts started by falling rocks or sharp edges should be finished with a knife, so that no person can later mistakenly assume the rope is safe. Sharp rocks are likely to be particularly damaging when rappels are used by novices, for their slow and jerky descents will cause far more wear than the swift, controlled rappels of the expert.

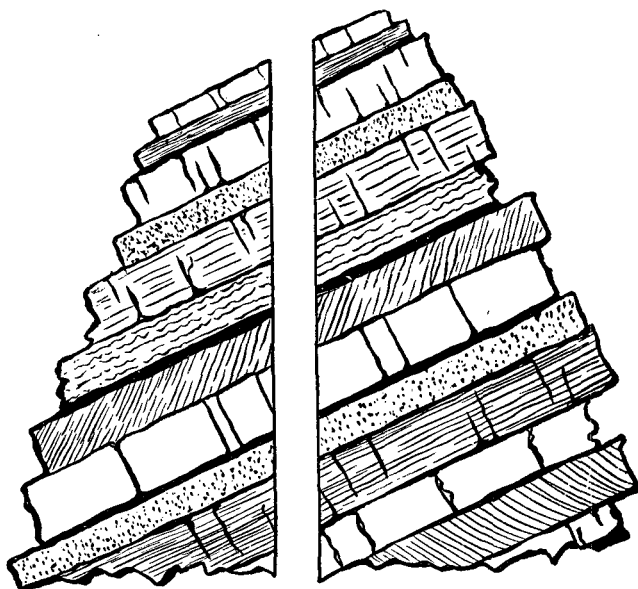

① *Difficult to climb.*

② *Easy to climb.*

Figure 25. Rock strata.

108. ROUTE SELECTION. **a. General.** Terrain must be appreciated if an efficient route is to be found through it with necessary speed. Every mountain-reconnaissance unit should include climbers experienced enough to be able to estimate friendly or enemy capabilities in the region with particular reference to time, skill, equipment, support, and weather required to cross mountain obstacles, and the route necessary to avoid mountain dangers themselves.

b. Rock-climbing reconnaissance. (1) *Scope.* The military rock-climber must make detailed reconnaissance, noting, with respect to each rock obstacle, the best approach, height, angle, type of rock, difficulty, distance between belay positions, concealment along the route, amount of equipment and number of trained climbers needed to accomplish the mission on or beyond the rocks. A key to good climb rates is to be found in the rock strata. If the strata dip toward the climber (fig. 25(1)) holds will be difficult as the slope will be the wrong way. However, strata sloping away from the climber and toward the mountain mass (fig. 25(2)) will provide natural stairs, with incut holds and ledges.

(2) *Vantage points.* At least two vantage points should be used, so that a three-dimensional understanding of the climb can be attained. Use of early-morning or late-afternoon light, with its longer shadows, is helpful in this respect. Actual ground reconnaissance should be made if possible.

(3) *Dangers to avoid.* (a) On long routes, changing weather will be an important consideration. Wet or icy rock can make an easy route almost impossible; cold may reduce climbing efficiency to zero; snow may cover holds; a cloudy night may be too dark for travel; a

lifting fog may remove necessary concealment too soon. A weather forecast should be obtained if possible.

(b) Smooth rock slabs are treacherous, especially when wet or iced after a freeze and rain. Ledges should then be sought.

(c) Rocks overgrown with moss, lichens, or grass become treacherous when wet. Cleated or nailed boots will then be far better than smooth rubber.

(d) Tufts of grass and small bushes that appear firm may be growing from loosely packed and unanchored soil all of which may give way if the grass or bush is pulled upon. Grass and bushes should be used only for balance by touch or as push holds, not as pull holds.

(e) Gently inclined but smooth slopes of rock may be covered with scree that will roll treacherously underfoot. Here the climber must not lean in.

(f) Ridges may be free of falling rock, but are usually topped with the most unstable blocks in the region; moreover, the climber is likely to skyline himself on a ridge. A route along the side of a ridge just below the top is usually best.

(g) Gullies provide the best defilade, and often the easiest routes, but are most subject to ambush and to rockfalls from natural or enemy sources. The side, or better, the wall of the gully is relatively free from this danger.

(h) Talus and moraine slopes (talus transported and left precariously balanced by glaciers) are not only tiring to the individual, but are a hazard to a party, since unstable rocks may roll several yards when disturbed. Climbers should close up intervals when climbing simultaneously. Large groups should attempt to find numerous parallel routes.

(i) Wild life, ranging in size from the ant to the mountain goat, contribute to the mountaineering hazards, usually through the faulty reaction of the climber who is surprised. The surprised climber should think before he acts.

(j) In electrical storms lightning can endanger the climber. Peaks, ridges, pinnacles, and lone trees should be avoided.

(4) *Rock falls.* (a) Falling rock is the most common mountaineering danger for the rock-climber. The most frequent causes of rock falls are: other climbers; great changes of temperature in high mountains and resultant splitting action of intermittent freezing and thawing; heavy rain; grazing animals; enemy fire, demolitions, and other defensive works.

(b) Warning of a rock fall may be the cry "Rock," a whistling sound, a grating, a thunderous crashing, or sparks where the rocks strike at night.

(c) Rock falls occur on all steep slopes, particularly in gullies and chutes. Areas of frequent rock falls may be indicated by abundant fresh scars on the rock walls, fine dust on the talus piles, or lines, grooves and rock-strewn areas on snow beneath cliffs.

(d) Immediate action is to seek cover if possible to move and if cover is available. If enough advance warning is given, the climber should watch the falling rock, present his narrowest profile, and not commit himself until he knows he is in danger. Otherwise he might move directly into its path by blindly trying to avoid it.

(e) Rock-fall danger is minimized by clean and careful climbing, and by judgment in choice of route.

Section III. MOVEMENT OF TRAINED PERSONNEL

109. FREE CLIMBING. Much of the movement of a trained climber whose mission may be that of guide, observer, assault-team member, scout or other security, will be without the aid or encumbrance of rope. Rope and climbing equipment may not be available where needed. The terrain may not be difficult enough to require use of rope. Enemy action may require greater speed than will be possible with rope, the danger from enemy fire overbalancing the danger of unroped falls. Or, once the route for the main body has been selected and found relatively easy to travel, security elements may need to make only short scrambles to either flank. Free climbing will usually sacrifice, however, the safety and team work that result from use of the rope.

110. ROPED (PARTY) CLIMBING. a. Purpose. Trained climbers tie together, two or three men to the 120-foot rope, whenever by so doing they increase their mutual safety and ability on difficult rock. When one man is climbing he is belayed from above or below by another man.

b. Climbing procedure and rope signals. (1)
General. In belayed climbing, where only one man can safely move at a time, the best man goes up first, and down last, and is the leader. The least experienced man does the opposite. When only two men are on a rope, they can move about three times as fast as three men on a similar 120 foot length of rope. Two ropes of two men each are the strongest party that can travel a given route quickly. Rope signals are used for silent communication.

(2) *Rope of two.* (a) No. 2 ties in, assumes belay position, anchors if necessary, belays, or motions No. 1 to climb.

(b) At same time No. 1 ties in, plans route, and climbs on signal from No. 2.

(c) While No. 1 climbs, No. 2 watches him, the rope, the route, and the rock, and begins to put resistance on the rope gradually when there is only about 20 feet of slack left.

(d) The belayer should always anticipate the direction of any fall, and prepare his belay so that it will be braced against the final direction of pull.

(e) When belay position is reached, 10 feet or more from end of rope, No. 1 signals "Off belay" (two jerks on taut rope), takes in slack rope, assumes belay position, anchors if necessary, signals "Climb" (two jerks). Whatever belay position is chosen by the leader will probably be used by the second man when the leader continues his climb. The position must be strong, because the leading climber, even when using pitons, will usually fall more than 10 feet if he slips.

(f) No. 2 meanwhile replies "Off belay" (two jerks), take off belay, answers "Climbing" (two jerks), follows No. 1's route climbing no faster than No. 1 takes up rope, signaling "Slack" (three jerks) when he wants No. 1 to pay out slack, or repeating "Climbing" when No. 1 takes up rope too slowly.

(g) If No. 2 is a proficient enough climber, he becomes the leader for the next pitch to be climbed; if not, he assumes No. 1's belay position.

(h) All signals should be given on a taut rope. To signal "Tension" climber places his weight on the rope (or one jerk) and belayer holds; belayer allows rope

to run only on signal for slack, whereupon he pays out only as much as is pulled in by the climber at that time.

(i) With two ropes of two men on the same route, the idle rope provides security or anchor.

(3) *Rope of three.* (a) No. 1 climbs to the first belay position, brings up No. 2, then continues to second belay, providing what security he can while No. 2 brings up No. 3 and follows No. 1.

(b) No. 3 provides security when not climbing, either in the military sense, or, where desired, as anchor man for No. 2 while he is belaying.

(c) Similarly, No. 1 may anchor No. 2 while No. 3 climbs.

(4) *Pitons for safety.* The leader of a climbing party uses pitons for protection whenever he feels that he is dangerously high above his belayer and is likely to fall. He also uses them if they help to speed up climbing, but does not use them in preference to natural handholds, which are usually far quicker to use. The leader using pitons should—

(a) Select, if possible, a route that will probably not require pitons, as it takes a great deal of time to drive them in.

(b) Carry enough pitons and snaplinks to take him over the pitch, allowing for bending and loss; they may be carried in a pocket where they are easily reached when in a delicate and awkward position.

(c) Place and test the pitons carefully.

(d) Choose a route for the rope that will reduce friction to a minimum.

(e) When friction is great, pull out enough rope for each step before taking it. If friction is too great, back down, belayed through the top piton, and remove some

of the snaplinks from pitons which are not longer needed. One method of reducing excessive friction is as follows: start the climb with two belay ropes, the belayer tending only one; snap in the second rope when friction becomes great, and have the belayer tend this rope instead, belaying through the pitons placed from that point on; tie the first rope into a snaplink, and leave it behind as a fixed line for subsequent climbers.

(f) Establish a well-planned belay and anchor, and plan a means for the No. 2 man to take it over quickly and securely if the belay position is cramped. It may be better for the No. 2 man to assume the lead.

(g) In a difficult position, snap into the piton as soon as it is in far enough to be of any possible value, and test it later.

(h) Have the last man up recover the snaplinks, but not the pitons unless their need is anticipated, or the available supply is small.

(5) *To remove pitons.* The climber should knock them back and forth in the crack with a piton hammer or rock, and when they are somewhat loosened, pull them out with a bight of the climbing rope which has been hooked into the snaplink. It is advisable to be well braced when pulling out pitons, as they often come out very suddenly, and to see that no one is close enough to be struck by the flying piton.

(6) *Friction.* The worst hazard in using pitons is the friction created where the rope bends around snaplinks, binds over rock between pitons, or runs around the belayer's body. The greater the friction, the more the climber must pull on the rope, and the more likely is his injury if he falls.

(7) *Tension climbing.* In tension climbing, the be-

layer holds the leader to the rock by means of a rope and pitons, the snaplink in each piton serving as a pulley. Thus the leader may be above or to one side of his belayer and still be able to climb, driving pitons successively higher for tension, even though the natural holds are inadequate. Tension climbing is necessary when an easier route cannot be found or used. Often it is used in one or more short difficult pitches in an otherwise easy route. The tension climber should—

(a) Drive pitons no closer together than is necessary for safety. The piton need not be so secure for holding body weight as for holding a fall.

(b) Never hook a finger in a piton, but put in a snaplink and climbing ropes, and hold on to them.

(c) Use rope slings for foot and handholds only when tension from the belayer will not hold him through his highest piton, high enough on the rock to place a higher piton, or when its downward pull on the piton is the safest pull.

(d) Rely on the belayer's tension, keeping both hands free for the work above.

(e) Use alternate (two-rope) tension, for the most difficult pitches. This is easier if there are two belayers. However, if there is only one belayer, the following method may be used: The rope from the leader's waist passes around the belayer's waist. The second rope, fastened around the leader's hips, runs to the same side of the belayer as the first rope, and beneath his hips. The leader climbs, the belayer holding him to the cliff with tension first on one rope, then on the other, always keeping one of the ropes slack so that the leader can snap into the next higher piton.

(f) The belayer should anticipate the leader's needs, so that few signals need be given.

(g) When the leader needs tension to climb a pitch, the second man will also need assistance on that pitch. This is furnished by rope slings left in the pitons or, if alternate tension has been used, one of the two ropes can be tied at the top as a hand line.

111. EXPEDIENTS. a. Simple fixed rope. Assuming that a pitch is easy enough, or must be climbed quickly by a few trained men, so that once the leader has climbed the pitch the others need use the rope only for guide line and occasional handhold, the following procedure may be used:

(1) No. 1 ties in, plans routes, and climbs on signal from No. 2.

(2) No. 2 belays, or may need only to see that the rope does not snarl.

(3) At top of pitch No. 1 takes up slack, either ties the rope securely to an anchor point or belays it around his body, signals "Climb" (two jerks).

(4) Others climb up rope, using it for all desired aid. If there is a second rope of two men on the same route, these men will climb the rope first, and make a similar installation for the succeeding pitch. One man climbs the rope at a time, and signals "Climb" when he has reached the top. The man who is last up the pitch so notifies No. 1, who coils the rope and continues with the climb.

b. Continuous climbing. Following is the procedure for dangerous, but not difficult climbing, in which an unchecked slip would be disastrous, but where a slip can easily be checked with a rope without using a belay

position. It may also be used for easy going between difficult pitches, to save the time of unroping.

(1) Party ties into rope. No. 1 carries one loose coil of rope to be paid out if the rope is jerked suddenly. He climbs slowly enough to minimize the effort of No. 2, who carries the rest of the rope. He selects a route behind trees or smooth rock points, so that these can give an indirect belay in case of fall. On short, tough pitches he may gather in rope from No. 2 after he is up.

(2) Nos. 2 and 3 watch the rope ahead, prevent its snagging in brush or loosening rocks, and keep it just taut enough to prevent dragging. They carry extra rope in a neat coil in either hand and take up or pay out rope from their coils if they go faster or slower than the man ahead. They climb as well as they can with the free hand.

(3) If there is any chance of a dangerous slip by one or the other, each man constantly looks for a good stance which he can get into quickly in order to stop the fall, or for a tree or rock belay point.

Section IV. MASS TROOP MOVEMENT

112. MOUNTAIN MARCHES. In assisting or preparing for marches through rugged terrain by troops with little or no mountain experience, the trained rock-climber's principal duties are:

a. Route selection and reconnaissance. He looks for the easy routes requiring neither special skill nor equipment.

b. Coaching in mountain technique. He advises his unit on proper pace, formations, and methods of most efficient mountain walking.

113. FREE CLIMBING. In terrain so rugged that precise routes must be followed, or on which fixed ropes would be desirable for inexperienced men but are not available, the trained climbers can be posted as guides at critical points, to coach or otherwise assist the untrained men over the pitches. Rock-climbers can be used to good advantage in giving all possible supplementary training to unit personnel and replacements who are to operate in mountain terrain. All possible expedients should be used to train such men to handle themselves efficiently and confidently.

114. AIDS FOR LARGE-UNIT MOVEMENT. One of the most important duties of the military rock-climber is to assist the unskilled men of his unit over difficult terrain. Aids for this work are fixed ropes, personnel hauling lines, and guide lines. Expedients may often serve well for all described equipment except rope.

a. Fixed ropes. (1) *General.* When a company assault-climber team consists of six men, effort is made to have them work as pairs within that team. The entire team can simultaneously set up two fixed ropes on separate routes, four men working on one route, two on the other. The procedure below provides security, speed, and as a final result a fixed rope that will adequately support green troops.

(2) *Procedure for four-man rope.* (a) No. 1 ties into climbing rope (carrying a second coil or rope over his shoulder if climb is easy enough to permit it and a second fixed rope is to be placed above the first); belayed by No. 2 he climbs to the top, signals "Off belay," ties his climbing rope to an anchor point, signals "Climb" and either goes out for security (if top has been reached)

or readies his coil of rope for repeating the process when No. 2 joins him.

(b) No. 2 belays No. 1; acknowledging "Off belay" signal, he anchors the bottom of the climbing rope, pulling it fairly tight, and on signal "climb" ascends, using the anchored rope as a headline. At the top he either goes out for security or belays No. 1 up any further pitch.

(c) No. 3, tied in another rope with No. 4, follows close behind No. 2, using the fixed rope, assumes belay position at top, and signals "Climb."

(d) No. 4, belayed by No. 3, improve the usefulness of the rope by anchoring it to pitons or other anchor points every 10 to 15 feet, in such a way that several men (one man to each section between anchor points) may climb the rope at the same time, and it is tight and close enough to the rock to require minimum exertion of the hands and arms. Procedure for No. 4 is as follows: Leaving 15 to 20 feet of slack in the rope, No. 4 ties it to the bottom anchor with a butterfly cinch, selects the best rope route for green troops, and with tension as needed from No. 3, places necessary pitons, securing the fixed rope to the pitons with figure-8 slip knots tied 18 to 24 inches below each piton and cinched up tight from immediately above. He places loose rocks where they won't be kicked, pads the rope where it rubs against sharp rocks, clears out brush that will interfere with pack-laden troops, and selects a route for the rope that will be as free as possible of rocks falling from natural or human causes. He anchors the rope at the top with a butterfly cinch, and then prepares to service the rope as troops use it, and assist men over difficult spots.

(3) *Procedure for two-man rope.* (a) No. 5's duties are the same as above, except that he also ties into the second rope instead of carrying it as a coil, having first paid it out in loose coils on the ground which will not tangle as he climbs. This second rope will be the fixed rope.

(b) No. 6 ties in the first rope and belays No. 5 with it. Upon receiving the signal "Climb" he follows the procedure for No. 4, above. If a second fixed rope is to be placed above the first pitch, No. 6 carries it up the first pitch as a coil.

b. Hauling lines. Lines for hauling equipment (par. 115) can be used for hauling personnel, particularly the vertical hauling line which is superimposed on difficult pitches of fixed ropes.

c. Guide lines. (1) A guide line designates a route over easy terrain. When the protection of smoke, storm, or darkness is used, a guide line may serve to lead from a forward assembly area to the base of a fixed rope, or to connect a series of fixed ropes. Any line, $\frac{1}{4}$ -inch rope or engineer tape, that will clearly mark the route can be used as a guide line, as strength is not needed.

(2) When laying out a guide line the climber should avoid crossing the desired route with the guide line. It is confusing and tiring to step over a guide line at every turn of the route. If the route is long, and time or lack of material for lines requires it, lay guide line over only those parts of the route that are hard to follow. When connecting fixed ropes and forward assembly area, lay guide line back from the fixed rope toward the unit. It will then not be necessary to lay it all the way back. A

very short guide line (30 feet or less) is of value at the base of a fixed rope if it is stretched at waist height and leads directly to the fixed rope. To find the fixed rope at night the soldier need only walk to the base of the cliff on one side of the fixed rope, then follow the base until the guide line is struck. When so used the guide line should be anchored to a flexible branch that can act as a shock absorber.

(3) When the 200-foot, $\frac{1}{4}$ -inch line is used as a guide line, 35 feet should first be cut off for connecting the guide line to intermediate points of support. Used guide line should then be saved, unworn portions being used later for smaller guide lines, small pieces for sling rope.

d. General precautions. Until the trained rock-climber has watched many inexperienced men on rock, he almost invariably overestimates their ability. He must remember the factors that will make the ascent of a fixed rope difficult, perhaps dangerously so, to the untrained man who arrives at the base of the fixed rope. He may be winded from a long climb up talus, he may be heavily encumbered by pack and weapon, his fingers may be numbed from a long wait in a cold forward assembly area; moreover, there is plenty of uncertainty ahead of him. The fixed rope must be set up so that the soldier arrives at the top ready to fight. Therefore, the route should not be too steep, and should favor traverses rather than straight ascents; the rope should not zig-zag across the climber's path, forcing him often to step over or under it; series of linked sling-rope half hitches, anchored at the top, greatly aid gripping the rope in ascents of steep pitches and overhangs. Assistance at a difficult pitch will raise an uncertain man's confidence.

Section V. MOVEMENT OF EQUIPMENT

115. HAULING LINES. a. Purposes. When inexperienced men carrying heavy loads are required to climb fixed ropes, it may become necessary to set up hauling lines to move the loads, and sometimes the men themselves, over gaps and streams or up cliffs. The lines may be horizontal, diagonal, or vertical. Expedients may often serve well for all described equipment except rope.

b. Horizontal line. This is used across gaps and streams. Both ends of a climbing rope are tied to suitable anchors, with a cinch at the most accessible end. If nylon rope is not available, the line should never be cinched so hard that there is less than 2 inches of slack in 100 feet of unloaded line. The load is attached to the line by means of a snaplink. Two climbing ropes are tied into an endless pulling rope, with loops for loads tied at the two knots so that a load may be placed on one end of the line while the previous load is removed from the other.

c. Diagonal line. This is used for raising and lowering loads on cliffs. The line is anchored in the same manner as the horizontal line, the cinch being tied at the lower end. Where possible, the angle of the line should be 45° or less. Often a bipod or boom must be improvised to keep the top of the line away from the rock and permit unloading. Heavy loads are attached by lowering the diagonal line to the load and lifting the load to the hauling position. It may be necessary to release the cinch to aid unloading at the top. Heavy loads may be hauled from either the top or, more usually, from the bottom, through use of snaplinks as pulleys. An

anchored Prusik loop will provide a ratchet effect in heavy hauls, if desired.

d. Vertical line (fig. 26). (1) *When used.* The primary use of the vertical line is in conjunction with the fixed rope, to assist men with packs on moderately difficult pitches, or actually to lift and safeguard men over very difficult pitches. For raising or lowering supplies or equipment, the fixed line is unnecessary. Vertical lines may sometimes be used on the steepest cliffs, where there is not enough space at the bottom of the cliff to set up a diagonal line, but where otherwise the diagonal line would have been preferred because it keeps the load out from the cliff.

(2) *Installation.* The fixed line (if used) is installed as for horizontal or diagonal lines. At the top a pulley is improvised of sling rope and a snaplink (two snaplinks if no nylon hauling rope). The pulley is anchored to a tree, pitons, or rock point high enough above the upper unloading ledge to keep the hauling rope free or almost free of the face. A bipod may be necessary to accomplish this. For a 100-foot pitch two climbing ropes are tied into an endless line similar to that used for a pulling rope for the horizontal line, and the load is pulled from below.

(3) *Aiding personnel.* When men are to be helped to the top, they may be tied in with a butterfly-knot loop slipped up under the pack, or, if enough snaplinks are available, by the following quicker method: two 6-inch butterfly knots are tied about $2\frac{1}{2}$ feet apart on either side of the knot joining the two hauling ropes at the bottom, and a like pair of butterflies are tied at the top. The two knots are brought around behind the climber and hooked together in front with a snaplink at about

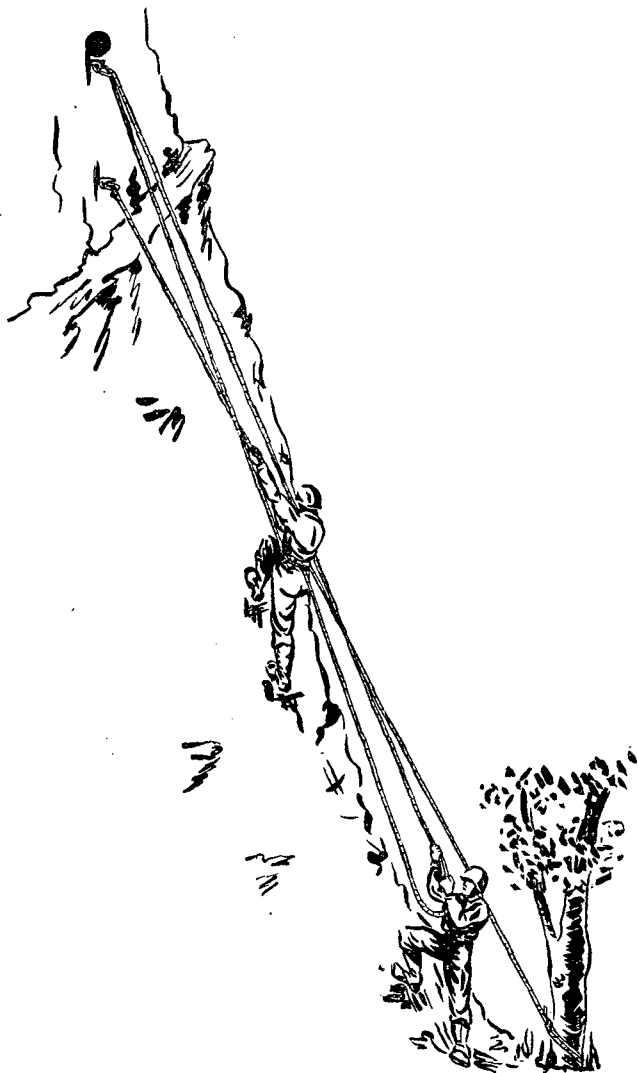

Figure 26. Vertical hauling line.

belt level. A second man can be snapped in at the bottom while the first is unsnapping at the top. Such hauls of personnel should always be made in conjunction with a fixed rope, by means of which each man can help himself in rhythm with tugs on the hauling rope by the crew below. Inexperienced men should have a safe and easy place to get off the rope at the top.

Section VI. TACTICAL EMPLOYMENT OF CLIMBERS

116. GENERAL. There is no fundamental difference between tactics in hilly terrain and precipitous terrain except that time estimates for travel must be revised substantially upward. The following paragraphs suggest how climbing technique may be employed. Standing operating procedures should be prepared in the required detail by units concerned.

117. GUIDES. Guides are primarily used as advisers to unit commanders and to assist troops over minor rock obstacles encountered in normally broken terrain. They should possess excellent route-finding and pace-setting ability and a thorough knowledge of the general practice and theory of rock-climbing.

a. As advisers they should—

- (1) Suggest best route of march.
- (2) Inform unit commanders of natural dangers and obstacles likely to be encountered.
- (3) Be prepared to estimate the time and means necessary for the movement of troops or equipment between any two given points.

b. In assisting troops they should—

(1) Maintain a steady pace at the head of the column, to prevent bunching and straggling.

(2) Help maintain proper march discipline with respect to pace, cadence, and distance.

(3) Be stationed at obstacles along the line of march directing troops and indicating alternate routes over bottlenecks.

c. Guides may be given limited command authority to insure their maximum effectiveness.

118. OBSERVERS AND SCOUTS. **a.** The rules for the selection of scouts and observers (FM 21-75) hold true in the mountains. To the characteristics and abilities normally required of a scout must be added agility and thorough training in military rock-climbing. The scout should also have a thorough grasp of mountain terrain and terminology, so that he can make accurate sketches and reports of his observations.

b. Scouts will ordinarily function in pairs. When a scouting mission requires crossing of precipitous terrain a climbing rope, a few pitons, six snaplinks, and a piton hammer will complete the team's climbing equipment.

119. RECONNAISSANCE PATROLS. **a.** Reconnaissance patrolling over precipitous rock terrain may best be accomplished by small patrols of one or two pairs of trained climbers.

b. Climbers may be used in day or night reconnaissance. Allowances must be made for the added difficulty and reduced speed of night climbing.

c. Expedients for party climbing will be found helpful in the execution of night patrols and will permit inclu-

sion of agile nonclimbers in the patrol. Addition of nonclimbers will however, greatly decrease speed of movement.

120. FLANK PATROLS. a. Climbers may expedite movement of flank security elements over difficult rock terrain. One or two climbers should be attached to each element, depending on the size of flank elements and the difficulty of movement.

b. When ruggedness of terrain is likely to enforce a rate of march on the flanks that is slower than that of the main body, flank security personnel should be grouped near the advance party. Smaller elements are then detached as necessary to reconnoiter and hold dominant terrain features on the flanks of the line of march. Flank outposts join the main body and proceed forward to rejoin the pool of flank elements.

121. COMPANY ASSAULT CLIMBERS IN ATTACK. a. One of the principal missions of military rock-climbers will be to lead the attack on a precipitous objective. The forces required to secure this objective from counterattack will generally be small, either a reinforced company or at most a battalion.

b. A suggested standing operating procedure for a company attack follows:

(1) The assault of the cliff will preferably be made at night, under cover of fog, or during a storm. If the night is dark, ropes may have to be set up at dusk or just after dawn. The noise of the movement may be covered by artillery or infantry fire. Undefended points of attack should be chosen. The use of at least two separated points increases the likelihood of success.

(2) In the attack, a complete daylight reconnaissance by the company assault team is desirable. If possible six routes should be chosen covering a front of from 200 to 400 yards. Of these, the two easiest routes should be picked for the installation of the first two ropes. Concealed locations for mortars are chosen and range cards prepared in advance. Platoon assembly areas are selected and routes to the foot of the cliff decided upon.

(3) Under cover of darkness, the company moves into its assembly area. Mortars go into position to deliver unobserved fire if the attack should be detected. The poorest adapted men and those likely to "freeze" on the rope are segregated and posted as local security around the assembly area. Those selected to climb the first rope are lined up back from the foot of the cliff and under cover. The assault climbing team will initially set up two ropes at points as far apart as possible to give dispersion and still retain control. Nos. 1, 2, 3 and 4 will establish one rope and Nos. 5 and 6 the other.

(4) At the hour of the attack, Nos. 1 and 2 climb the cliff, anchoring their climbing rope at the top, and immediately move out to provide security. Nos. 3 and 4 follow as closely behind No. 2 as possible, place pitons, and secure the first line. Nos. 5 and 6 climb to the top, place their pitons over a different route, and secure their line. They then set up a hauling rope.

(5) Six riflemen selected for their agility follow No. 2 up the fixed assault rope and relieve Nos. 1 and 2 as security. The riflemen are followed by two observers with radio and wire reel to direct the fire of company and attached mortars. As soon as the hauling rope is set up, both light machine guns are hauled up and put in position to protect the climbing of the main body.

(6) When a rope has been established, one assault climber remains at the rope to service the line and to aid the inexperienced climbers up the route. The other climbers will set up other ropes until four to six are in position, depending upon the ease of installation. At least two of the routes should have hauling lines which can be manned by inexperienced men.

(7) Following the mortar observers and the light machine guns, a rifle platoon is moved to the top as rapidly as possible. It reorganizes at the top and takes up a defensive position that will protect the climbers from observed small-arms fire. The platoon leader commands all troops at the top of the cliff and integrates the machine gun and mortar fire.

(8) The assault platoon is followed by the company headquarters, artillery liaison party, ammunition, and the remaining riflemen. The 81-mm mortar units and their rifle security are the last troops to climb the rope. The ropes may be left in position for moving supplies or evacuating wounded, or may be taken forward to aid in a continuation of the attack.

(9) In using the above standing operating procedure, prior detailed planning and careful organization are essential to success. When additional ropes or climbers are required, these should be attached from other companies within the regiment. The initial troops to climb the cliff, including the first platoon, should climb with only their weapons and a minimum of ammunition. The remainder of their equipment will be brought up by hauling lines.

122. COMBAT PATROLS. a. Patrols operating over precipitous terrain should have as their base the

climber team. Nonclimbers may be added in varying proportion according to the estimated climbing difficulty and mission.

b. If more than one point of attack is to be used, or a more powerful patrol is needed, additional climbing teams can be employed.

c. Patrol leader should be familiar with abilities and limitations of company climbers. He should be a trained climber.

d. Nonclimbers should be selected with careful consideration of their natural agility and endurance.

Section VII. MOUNTAIN STREAM CROSSINGS

123. PURPOSE AND PROCEDURE. **a.** The technique of the trained climber may be used in crossing mountain streams. Sudden rains or thaws can change placid streams into roaring torrents. These may have to be crossed without special equipment or the assistance of specialized troops. All mountain soldiers should be trained in crossing mountain streams.

b. The best time for crossing is in the early morning when the water is low. As glaciers, snow, or ice melt during the day, the rivers rise, reaching their maximum height between midafternoon and late evening, depending on the distance from the source.

c. Prior reconnaissance of possible crossings must be made before the arrival of the main body, so that the best place for the crossing may be selected. A crossing point should be chosen, if possible at the widest point on the stream, or where it branches into several smaller streams. Cover should be available on the banks. Whenever possible, select a point where there are few, if any,

large stones in the river bed. Water is turbulent over large stones, while it flows smoothly over small stones. Large stones increase the difficulty of maintaining an easy footing. The place for crossing should be clearly marked on both banks.

d. Shoes should be worn to prevent foot injuries, but socks should be removed and kept dry.

e. A shallow stream with a moderate current can be forded without the use of ropes or logs. Men should cross in a line four abreast without linking the arms or affording each other support. The strongest and most able men are placed at the ends of the line for additional safety. The river should be crossed at an angle, downstream. The feet should be wide apart, and kept flat with the bed of the stream, and should always be set down on the upper side of any obstruction in the stream bed. The legs should be dragged through the water, not lifted, so that the force of the current will not throw the individual off balance and drag him under.

f. Swifter and deeper rivers may be crossed by groups of men assisting each other.

(1) To cross using the ring method, a squad of men form in a ring, locking hands with each other and placing the arms behind their backs. The body is bent well forward.

(2) In the chain crossing, a squad of men forms in line, lock arms with each other, and then cross their own arms and lock their hands in front to give added support. The line then moves across diagonally downstream.

g. Wherever possible, and when the degree of experience permits, torrential streams should be forded individually in order to effect a speedier crossing. Only experienced soldiers should attempt an individual cross-

ing of a strong, deep current. A balance pole may be used and worked ahead of the individual, always on the upstream side. The weight of the body must be evenly distributed between the pole and the feet, to maintain the necessary two points of support. The pole is first moved forward and planted, and the feet are then moved ahead.

h. (1) Rapids, or a fast-moving deep stream which is filled with large boulders, may be crossed by jumping from stone to stone. Logs or trees may be felled from the banks to facilitate the movement. As a safety measure, the rope should be used during the crossing. Individuals tie themselves in and are belayed by the security man who must pay the rope out gradually in order that the movements of the men will not be impeded. The butterfly knot should be used for the tie-in. The standing belay may be used by the security man.

(2) When jumping from boulder to boulder, the soldier should jump from a crouching position, pushing off simultaneously with both feet, and landing with both feet flat on the rock.

(3) The first man to cross rigs a rock belay and helps to insure the safety of those following.

i. (1) If the current of a river is rapid and deep, and yet can be crossed by using a rope support, a hand line is strung from bank to bank. The most experienced individual is tied in to a rope, and belayed across the stream. The rope is then tied in to whatever supports can be found on each bank, and the unit crosses in column.

(2) When crossing it is imperative that each individual stay on the downstream side of the rope, as the current has a tendency to pull one under the rope.

(3) If equipment is being carried, it is advisable to use snaplinks on the hand line for additional security.

(4) For carrying an injured man across, a rope seat may be made and attached to the individual who is to carry the injured man. The injured man is then hoisted to the back of the carrier and fitted into the rope seat. For additional security, a snaplink attachment is made to the hand line from a rope around the carrier's waist. The carrier then makes the crossing as prescribed for the other individuals.

(5) Rescue posts are set up at various points downriver on both banks. These posts should be manned with the best men, equipped with ropes and poles. If the current sweeps a man off his feet and downstream, he is then rescued at the rescue posts.

(6) The last man to cross removes the rope from its belay point, ties himself in, and is belayed across the river from the opposite bank.

j. Where powerful torrents of water between sheer cliffs are encountered, a horizontal hauling line should be used.

(1) The individual selected to take the rope across must be the best trained, most experienced man in the unit. He ties himself in securely, taking the two free ends of the rope with him. The middle of the rope is snaplinked onto a separate loop which has been securely fixed to a large smooth rock, acting as anchor on the near bank of the river. The man crossing uses a balance pole as described in paragraph 123g. The stronger the current, the greater is the angle at which the pole must be placed in the water.

(2) The crossing is assisted by the belayer, who pays out the rope as the crossing man advances. If there are

large boulders protruding from the river and lying in or near the path of the man crossing, he should utilize the rocks by crossing so that the rope falls against the upstream sides of the stones, thus affording himself an intermediate belay.

(3) As soon as the crossing man arrives on the opposite bank, he ties the rope to a large smooth boulder, looping the rope around the stone several times. If a large rock is not available for this purpose, a piton can be driven and the rope tied in with a snaplink. Stout trees or stumps may also be used.

(4) Once the rope is tied in, it is pulled taut and so tightened from bank to bank that it is several feet above the water.

(5) Individual rope seats such as are used in rappelling with a snaplink may be made up for each man. The snaplink on front of the rope seat is then snapped into the crossing rope and the individual swings out, pulling himself across. Only one man should cross at a time.

Section VIII. SPECIAL CLOTHING AND EQUIPMENT

124. REFERENCE. For detailed information on clothing and equipment, see TM 10-275.

125. SPECIAL CLOTHING. Units operating in temperate climates during the summer, tropical climates, and in mountains that cannot be classified as alpine, will not require any items of special clothing. The field uniform prescribed for infantry units is satisfactory, with

the exception that service shoes should have the rubber composition sole essential for good traction on rock. Mountain boots with rubber-cleated soles may be available in certain combat areas. These boots hold better in mud, snow, and on wet rock, give better protection to the feet, and will last many times longer than service shoes. Leggings should not be worn in difficult climbing.

126. CLIMBING EQUIPMENT. a. *Rope* is perhaps the most important single item of all the special equipment needed. Quantities of rope will be needed for a variety of purposes by all arms and services. The 7/16-inch and 1/4-inch manila rope and the 1/2-inch sisal rope are the sizes and types most commonly used for lashing, hauling, and bridge construction. These ropes can be used for assault climbing if nylon is not available. The rope is issued in 120 foot coils. Strict supervision is imperative in order to prevent needless cutting into shorter lengths. Because rope weakens with age, weathering, and rough treatment, it should not be used too long at the risk of losing men and equipment, but should be replaced as soon as it shows signs of age, non-resiliency, weakness, or excessive wear.

(1) The rope is a soldier's lifeline and should be treated as such. It should be kept in good condition, out of the dirt, out from underfoot, and in a cool, dry place when possible. It should be inspected regularly for fraying. Where badly frayed, it should be cut and the loose ends whipped. A climbing rope should never be spliced because of the danger of the splice jamming in crevices or weakening the dynamic strength of the rope.

(2) Rope strength (minimum breaking strength)

when new: 7/16-inch nylon, 4,000 pounds; 7/16-inch manila, 2,200 pounds; 1/4-inch manila, 600 pounds. The rope will lose about 40 percent strength in 9 months from age alone. When manila rope is bent sharply, as around a snaplink, it loses about 40 percent of its strength at the bend. Similarly, knots weaken rope. Nylon loses only about 3 percent in a snaplink bend. Manila loses much of its stretch and effective strength after it has been subjected to a very heavy load, as in a hard fall or by being stretched too tight in a horizontal hauling line. Nylon holds its elasticity much better. The effective strength of a new nylon in holding a fall is five times that of new manila.

b. *Pitons* will tear apart at about 2,000 pounds of strain. Well-placed pitons have pulled out of cracks at 600 to 2,200 pounds strain. They are weakened too much for further use if bent back and forth severely in removal.

c. *Snaplinks* will open up, the metal straightening out, at 2,000 pounds of stress. However, the gate will open with just a few pounds if the snaplink is not placed carefully on the pitons.

d. The *piton hammer* point is used for chipping ice off rocks and to help find and clean out cracks. The head is for driving pitons in cracks. The handle is not strong enough to permit pulling pitons out with the point.

e. *Packboards* with adaptors for carrying various weapons and loads, are useful carrying devices. They are indispensable in terrain where most supplies and equipment have to be manhandled. Any load that can be carried by a man, regardless of size or shape, can be lashed to a packboard and carried without discomfort, leaving both hands free for climbing or handling weap-

ons. If necessary, packboards can be utilized in the construction of emergency litters or used to sleep on when the ground is wet.

f. Field glasses. The constant need for distant observation increases the use of field glasses. The distribution of all field glasses in a unit must be made with a view to deriving the maximum use from each pair.

g. Sniper's rifle. The frequent and excellent opportunities for sniping and for accurate long range rifle fire suggest the increased use of the sniping rifle. Men armed with this weapon must be thoroughly experienced in its use and be specially trained as snipers.

h. The *ice-ax* is primarily an aid in negotiating ice fields and glaciers. It is also useful in mountain terrain where steep grass slopes predominate.

Section IX. CLIMBING SCHOOL

127. GENERAL. A carefully integrated, organized, and competently staffed climbing school is the best means for developing expert military rock-climbers. Training should be continuous and uninterrupted for best results.

128. SELECTION OF STUDENTS. **a. Enlisted men.** Students should be volunteers who fully understand exactly what they are undertaking. Preference should be given to strong, wiry men of medium or above average height, who have steady temperament and above-average intelligence.

b. Officers. In the selection of officer students, mental traits should receive prior consideration. Steadiness and the ability to improvise are the most important;

intelligence and physical endurance are only slightly less important.

129. INSTRUCTORS. a. Selection. In addition to meeting the qualifications of prospective students, instructors should be able to explain clearly and demonstrate precisely both theory and practice, when handicapped by lack of uniform instruction areas.

b. Training. (1) Instructors should be given a course closely resembling that to be given to students.

(2) Training may be considered complete only when a candidate cannot only do, but also can explain clearly every operation he has been taught.

(3) Care should be taken to acquaint instructor classes with varied rock terrain to include all areas in which he will teach.

(4) Safety precautions must be stressed. Avoidance of accidents depends largely on the instructor's understanding of their causes.

c. Duties. The instructor is responsible for the safety and training of his class and the proper care of the equipment. Students should be graded on ability to perform required operations, understanding of subject matter, and special leadership or instructional ability. Continued unsatisfactory grades should result in the rejection of the student receiving them.

130. SUPERVISORS. The supervisor oversees the conduct of training. He should—

a. Make sure that safety precautions are not being overlooked.

b. Correct errors of technique and instruction.

c. See that grades and other necessary records are maintained properly.

d. Act on all complaints and suggestions personally if possible, or refer complaints to proper authority.

e. Solicit suggestions for improvement of training from instructors and students.

f. Assign areas fairly and see to it that classes do not endanger or interfere with each other.

g. Encourage interchange of areas by instructors, and encourage regular exchanges of areas with other supervisors.

h. Acquaint himself with, and constantly seek to develop, improved techniques and training methods.

i. Organize and be prepared to present demonstrations.

131. CLASS ORGANIZATION. The following organization is suggested:

a. The company, under the chief instructor, is grouped into an even number of platoons.

b. Classes are grouped into platoons under the control of the platoon supervisor and his assistant. Size of platoons is governed by the limiting effect of terrain on control. Platoon size should not normally exceed 12 classes. Platoons should be kept intact so far as circumstances permit.

c. The basic class contains 6 men. At the beginning, classes may contain 10 men. Individual soldiers should be grouped according to organization. Officers should be grouped according to component and organization. No class should contain both officers and enlisted men until the climbing exercise phase of instruction.

132. TRAINING AIDS. a. General. Training aids should be used to supplement practical work on the rocks, not as a substitute for it.

b. Training films. Training films and film strips should be used primarily for orientation. In the absence of appropriate films, lectures supplemented by posters are an adequate expedient.

c. Belay tower. (1) *Function.* Cliffs suitable for safe holding of severe practice falls are seldom available. The belay tower (fig. 27) will accommodate six classes, two ropes being used concurrently on each face.

(2) *Number.* Enough belay towers should be built to accommodate one-third of all classes at one time.

(3) *Employment.* - (a) Faller ties into end of climbing rope with bowline on a coil under buttocks. Number of loops on coil is changed periodically to distribute wear on rope.

(b) *Belayer* ties in on end of ropes using bowline, assumes desired position, and anchors with bight of climbing rope to eye-bolt in anchor plate.

(c) Instructor takes position on top of tower between belayers where he can see fallers and belayers.

(d) Practice falls progress in severity until the belayer holds, to the instructor's satisfaction, falls of 4 feet (measured by the amount of slack accumulated by the faller prior to his fall) for the sitting and the standing positions.

(e) Faller and belayer change over and procedure is repeated until entire class has received instruction.

(f) Unoccupied students may learn rope signals while rehearsing rope management for slow-motion, simulated falls.

(g) Rope signals will be used throughout practice fall

instruction, excepting as a warning for a fall, which will be "Fall."

(h) The training company is divided into two groups, each using the belay tower and vicinity for $\frac{1}{2}$ day.

(i) Each group is divided into three smaller groups, two of which may practice falls at one time. The third group receives instruction in knot tying. Knot tying groups change every 80 minutes.

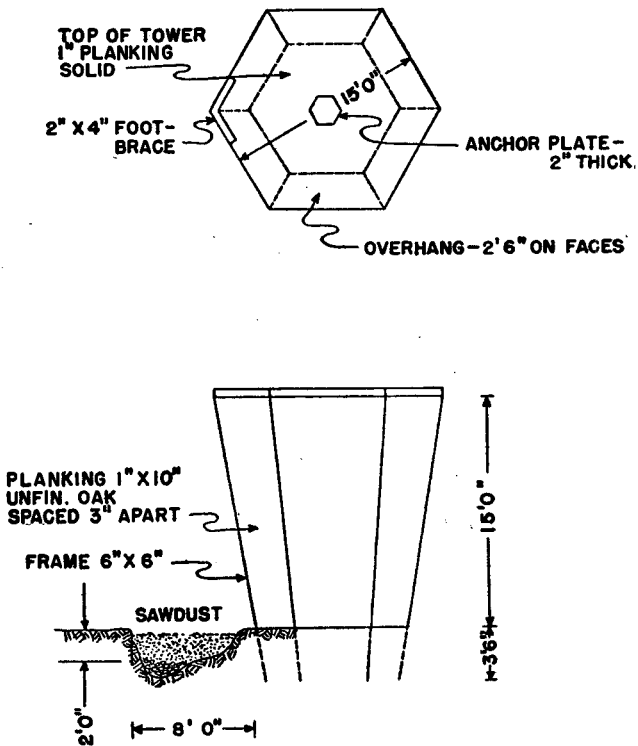

Figure 27. Belay tower.

d. Log ramp (fig. 28). (1) *Construction*. A wall substitute may also be constructed from logs and rough lumber. This wall is built of peeled logs, 10 to 12 inches in diameter and about 30 feet long, placed vertically against a gravel bank, or braced to stand at an angle of 75° from the horizontal. A high ramp of logs at an angle of 45° is valuable for basic climbing. Two separate climbing routes are laid out with crossovers to

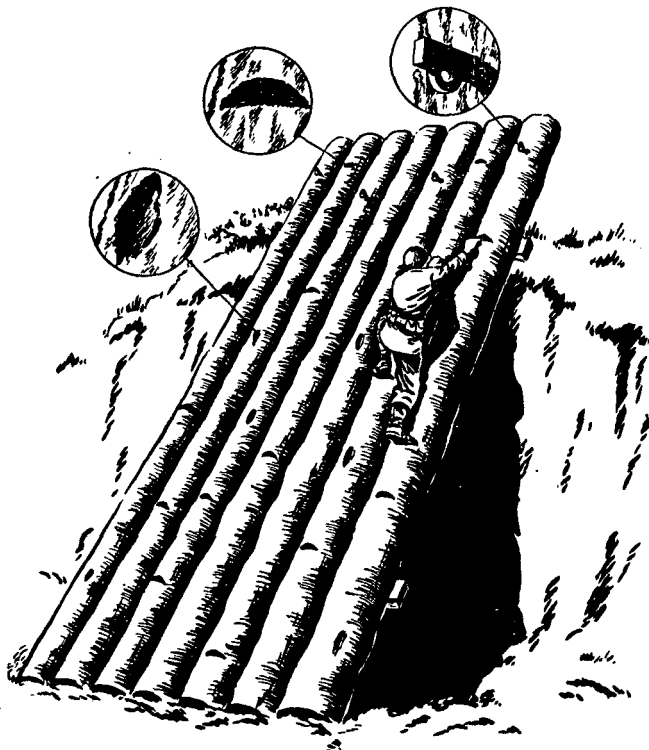

Figure 28. Log ramp as training aid.

permit traversing at several points. Hand and footholds outlining the routes are chiseled. Some of the holds should be cut to slope down and out, and others should be vertical to provide cross-pressure for hands and feet. A fingertip traverse, having handholds but not footholds, is desirable for strengthening the hands.

(2) *Use.* Pitons, bolts, or piping may be inserted for belays and climbing. Belayers can snap into these by using a rope sling and leaning out from the logs. Tapered wood blocks should be placed above pitons to prevent the climber from hitting the projecting pitons in case of falls.

Section X. SUPPLEMENTARY TRAINING

133. PURPOSE. The function of supplementary training is to—

a. Familiarize unit commanders of climbers with military rock-climbing.

b. Achieve coordination between climber teams and their units.

c. Recondition climbers who have long been absent from mountain terrain.

d. Provide necessary training for personnel who are not being trained as expert climbers.

134. METHOD OF TRAINING. a. **Orientation.** Troops and unit commanders can be orientated by means of a 1-day familiarization course, to include explanation and demonstration of all major phases of training. The demonstration may be spectacular, to hold audience interest, but it should not misrepresent either the skills or the proper employment of the climber.

b. Practical work. All unit personnel should practice—

(1) Balance climbing on low pitches with safe landing spot.

(2) Hauling lines; spectators should be encouraged to haul each other up and down.

(3) Fixed ropes on a moderately difficult route calculated to increase respect for trained military rock-climbers. This, and other phases of practical work, should be under the supervision of instructors and trained unit climbers, if these are available.

c. Coordination. Having received training in military rock-climbing, climbers of units should, in unit problems and maneuvers, be given the opportunity to demonstrate and develop their skill as climbers and their value to their unit when used as such.

d. Conditioning. (1) Troops who are not used to operating in mountain terrain or who have not done so for a long time will lose most of the benefits of specialized training if they are not in strong physical condition. Steep, rocky terrain, gravel pits, quarries, log ramps, rappel towers, and cross-country marches with natural and artificial obstacles, are excellent conditioners.

(2) Every man must receive training in the use of fixed ropes.

(3) One company in 4 consecutive weeks, training twice a week on the course described below, can acquire the necessary proficiency. The company can be put over the course in 20 minutes. The course should include:

(a) A 40-foot suspension traverse between trees, poles, or rocks.

(b) A hand-over-hand rope climb ascending a low-

angle log ramp where feet and legs, and not the hands, are used to lift the body.

(c) Descent of low-angle slope where a hand-over-hand climb down, or rappel, can be accomplished.

(4) Properly conducted mountain marches emphasizing proper pace, breathing and technique of movement are valuable.

e. Climbers may be used as instructors in mountain marching and over normally broken terrain. They should be allowed to practice climbing under the supervision of the battalion climbing officer.

Section XI. EXERCISES IN CLIMBING

135. GENERAL. a. Purpose. Exercises outlined in this section are only suggestions and may require revision to suit them to existing terrain. They should be short, vigorously executed, and provide climbing action for all participating students. When action stops, students lose interest.

b. Instructors. All instructors charged with the duty of observation and criticism should be thoroughly familiar with the purpose and method of the exercise, as well as all climbing technique and tactics concerned. They should make suggestions necessary for safety or to supplement data omitted from previous training of the student.

c. Students. Orientation of students to all phases of the exercise should precede the problem. Students who are charged with the responsibility of moving untrained troops during exercises should be cautioned against the possible reactions when untrained men are exposed to height and rock fall.

d. Critique. The critique should be held in view of the rock terrain used in the exercise. As a basis for the critique, errors commonly committed in each exercise should be discussed, and the students should be commended for absence of errors as well as criticized for the errors committed.

136. MOUNTAIN-WALKING COURSE. a. Purpose. To indicate proper technique in travel through various terrain types and obstacles.

b. Method. (1) The course should be laid out to include an ascent and descent of about 500 feet in $\frac{1}{2}$ mile, passing over or through large and small talus, steep grassy slopes, woods, ledges, easy chimney, down timber, and scree.

(2) The student travels the course as part of a column of squads under squad control. He is given no coaching ahead of time, but is allowed to use his own judgment.

(3) Instructors should be posted at various obstacles along the course to observe proper and improper technique. They should make notes if necessary, and prepare to take part in critique.

c. Common errors. (1) *Talus.* Too much use of hands for balance; poor rhythm in pace, with stops and starts from rock to rock; not enough care used in selecting well-anchored rocks to step on; stepping too far or too high. The route should be selected several steps ahead, and the climber should move with a confident rhythmic stride. Silent movement is desirable.

(2) *Steep grass slopes.* Failure to use uphill side of clumps for steps; selection of too steep a route; leaning in to the hill.

(3) *Woods.* Tendency on steep slopes to grasp small

trees for support, thus shaking tree crowns and disclosing position; branches whipped in faces of others. Trees should be grasped at base, low enough to eliminate quiver. Climber should move only in wind when enemy observation is suspected. Branches should be pushed over the head and backward.

(4) *Ledges*. Tendency to walk toward inside, where projections may throw soldier off balance and where footholds are often poorer; tendency to lean in for protection. The climber should choose a route free from cliff on uphill side, remain upright in posture, taking care not to step on small gravel that might roll underfoot.

(5) *Easy chimney*. Usually such an obstacle becomes a bottleneck, and delays entire column. Several routes should be taken over bottleneck to designated assembly point.

(6) *Down timber*. Entire body raised in stepping over log; loose bark on slippery surface used for foothold. The climber should walk around obstacle if it is at all difficult; step over it rather than upon it, leading with the uphill foot; if stepping upon it, he should not raise the entire body.

(7) *Scree*. Not enough care in selecting footholds with best support on ascents; leaning back on descents; failure to move continuously enough to make use of momentum to prevent sliding during short traverses between islands of support; failure to follow in packed footprints of man ahead.

(8) *Pace*. Too fast. Proper cadence on long steep marches may vary from 75 down to 40 and lower. Under heavy load, in high altitude, on 3,000 to 4,000-foot climbs, or at night, the rest step may be used (short pause after each step).

(9) *Distance.* Neither great enough nor properly used; excessive accordion action in column, with many starts and stops. With correct distance of 5 feet between men, 10 to 20 yards between squads, 30 to 50 between platoons, and with this distance slowly taken up or let out as the terrain requires, no man should have to stop anywhere on the course. Unit leader must anticipate closing of the gap between units, and shorten and slow his pace to delay or prevent closing of the gap.

(10) *Route.* Too steep, or failing to make good use of best footing. Route should be no steeper than permits walking with foot flat on slope rather than on toes. Lead man should select his footing carefully; others should follow in his footsteps.

137. COMPANY ASSAULT CLIMBERS IN ATTACK (par. 121). **a. Purpose.** To indicate correct procedure for the company assault team in attack of a steep rock obstacle.

b. Method. (1) *Obstacle.* A 100- to 200-foot cliff.

(2) *Situation.* Because of apparent inaccessibility of cliff, top of cliff is held very lightly. No recent enemy action has been observed.

(3) *Student team.* Six men with basic weapon and appropriate climbing equipment will—

(a) Make a visual reconnaissance of the cliff.

(b) Give an estimate of the time necessary to establish two fixed ropes up it.

(c) Make a plan of attack.

(4) *Instructor.* Issues fragmentary field order covering situation and hour of attack. He observes all phases of preparation and execution, and prepares a critique with the aid of an observer on top of the cliff.

c. Common errors. (1) Lack of previous planning; estimate of time and equipment wrong or lacking.

(2) Poor reconnaissance; failure of reconnaissance to disclose best route; noisy reconnaissance.

(3) Improper placing of fixed rope; operation noisy; pitons poorly placed; rope tied in poorly; poor route selected; security not established at top of cliff; inadequate organization.

138. ROCK-ENGINEER COURSE (par. 115). **a.**

Purpose. To indicate possible procedures for the movement of an 81-mm mortar over various types of terrain and obstacles.

b. Method. (1) The course should be laid out to include—

(a) The ascent of a cliff 35 to 45 feet high, a cliff 65 to 90 feet high, and a steep talus slope over 150 feet long.

(b) The descent of a steep rock or dirt slope of 40° to 45° .

(c) The crossing of a gap, such as a steep-walled ravine, or between a pinnacle and the main rock face.

(d) The descent of a 40 to 60 foot vertical rock face.

(2) *Student engineer team.* Two men with equipment they have selected after ground reconnaissance, are charged with responsibility of the movement of an 81-mm mortar section over the prescribed course.

(3) *The instructors.* These are posted at each obstacle. They observe the solution of each problem by the student, and help prepare and assist in delivering a critique.

c. Common errors. (1) Faulty estimate of equipment needed.

(2) Best hauling line not used; lines not in best locations.

(3) Insufficient use of mortar crews to assist in movement of weapons.

(4) Improperly tied knots or cinches; poorly anchored lines; failure to observe common-sense precautions.

(5) Failure to exercise proper care to avoid damaging weapons.

139. ESTABLISHING OBSERVATION AND SNIPER POSTS. a. Purpose.

To test individual climber's and two-man climbing team's ability to overcome difficult terrain obstacles quickly and silently in reaching designated positions.

b. Method. (1) *Obstacle.* A face, ridge, chimney, or pinnacle (route boundaries may have to be defined) which will test the climbing team's or climber's ability. Probable direction of enemy designated.

(2) *Team.* Single climbers should not be used if climbing is exposed and difficult. The two-man team or combinations of two-man teams are ideal. Climbers armed with basic weapon proceed after visual reconnaissance to cliff and climb to designated position, using all possible cover and concealment. Climbers take up concealed positions and record presence of objects or persons visible using methods outlined in FM 21-75.

(3) *Instructor.* He observes and records the actions of the climbers from designated enemy position; helps prepare and may deliver a critique.

c. Common errors. (1) Failure to make adequate reconnaissance.

(2) Failure to select easiest covered route or covered position.

(3) Failure to maintain tactical silence.

(4) Unnecessarily slow climbing; poor rope management, causing rocks to fall.

140. SCOUTS. a. Purpose. To test the ability of individual climbers, or of two-man climber teams to select a suitable line of march over broken and steep terrain; to recognize those portions of the line of march which will require special aids; to recognize common dangers.

b. Method. (1) *Course.* To include an ascent and descent of at least 1,000 feet, and at least 1 horizontal mile in length; broken and steep terrain, rock cliffs and other terrain obstacles; a wide selection of routes.

(2) *Student.* Equipped with basic weapon, compass, map, notebook, pencil, and climbing equipment, the scout or scout team will proceed from the initial point (indicated on map) toward a designated objective. He will choose the best possible line of march, recognizing the special aids his unit will have to employ in following him. He will make a sketch and make notes of obstacles and danger areas, such as those subject to rock fall from natural and artificial causes. Where terrain bottlenecks occur, he will reconnoiter them and adjacent terrain for alternate routes.

(3) *Instructor.* He accompanies scout(s), observing and recording mistakes. He assists in preparing and may help to deliver a critique.

c. Common errors. (1) Failure to make successive visual reconnaissances from commanding terrain features encountered in line of march.

(2) Poor choice of route; failure to go around, rather than over prominent terrain obstacles; failure to avoid terrain features most subject to enemy observation or swept by rock fall.

(3) Failure to reach designated point.

(4) Failure to record obstacles encountered and alternate routes as required.

141. SCOUTING AND PATROLLING BY NIGHT.

a. Purpose. To demonstrate the ability of the patrol to apply the principles of night scouting and patrolling (FM 21-75) to military rock-climbing.

b. Method. (1) *Coursé.* Laid out to include walking on leaf-covered slopes, talus, moderately difficult climbing, easy scrambling; setting up and use of rappel. Difficult climbing should be low (not higher than 12 feet above a good landing spot) and should not exceed a 70° angle.

(2) *Student.* Single climbers or groups, equipped with a climbing rope, travel course, maintaining tactical silence and light discipline.

(3) *Instructor.* Instructors are posted at frequent intervals along the course. They listen for unnecessary noises and direct patrol from station to station; prepare comments for use in the critique.

c. Common errors. (1) Rolling or kicking rocks, causing them to fall. This error can be corrected by keeping weight over feet, and by moving carefully with special attention to how the rear foot is raised.

(2) Shaking trees and branches, disclosing position.

(3) Failure to rappel carefully so that rocks are not knocked loose.

(4) Failure to avoid sky-lining.

142. COMBAT PATROL. a. **Purpose.** To give the climber team and attached elements practice in functioning as a climber combat patrol.

b. **Method.** A tactical problem, in which the climber combat patrol, under control of the company climbing officer, is called upon to eliminate an enemy combat outpost on dominant and precipitous terrain. For the problem a suitable terrain feature is selected, and a situation and fragmentary attack order is given.

(1) *Terrain obstacles* are a cliff or spur 50 to 200 feet high, and a talus approach of more than 100 feet, if possible.

(2) The *situation* is tactical. Enemy position is held by a light machine-gun section and mortar section with rifle security, at a distance of 1,500 yards from friendly forward elements.

(3) The *patrol leader* is informed of situation and given attack order at H-3 hours. He makes a visual reconnaissance, forms a plan of attack, and briefs his squad and climber team leaders.

(4) The *climber noncommissioned officer* divides climbers into three units of two men each, and procures necessary climbing equipment, rations, weapons and ammunition for climbers.

(5) The *squad leader* divides his squad into security element, base of fire element, and a maneuver element to be attached to each two-man element of the climber team. He draws necessary ammunition and rations.

(6) *Attack.* Combat patrol crosses line of departure at H-hour and attack continues according to plan.

(7) *Observers.* Instructors acting as observers accompany patrol and are stationed with enemy detail on

objective. They record observation and assist in preparing and delivering critique.

c. Common errors. (1) Failure to organize attack effectively or procure necessary equipment.

(2) Assault teams are not coordinated well with base of fire element.

(3) Climbers do not attack aggressively.

(4) Climbers warn enemy of their presence prematurely by shouting or dislodging rocks.

(5) Climbers do not choose best routes; are stopped unnecessarily by difficulty or enemy fire through failure to use covered approach.

CHAPTER 6

WEATHER

Section I. GENERAL

143. IMPORTANCE. a. Mountain weather can be either a dangerous obstacle to operations or a valuable aid, according to how well it is understood and to what extent advantage is taken of its peculiar characteristics. Trained men who are well clothed, equipped, and supplied may often convert such weather into an ally rather than an enemy.

b. Weather often determines the success or failure of the mission. Mountain weather is highly changeable. Military plans arranged in advance of an operation are relatively inflexible. Every effort must be made to anticipate the weather, and also to allow sufficient latitude in the time schedule so that the leaders of subordinate missions can use their initiative in turning the highly important weather factor in their favor. The clouds that frequently cover the tops of mountains, and the fogs that cover valleys offer an excellent means of concealing movements which normally would have to be made under cover of darkness or smoke. Mud can be overcome by diligent pioneering and intelligent use of motor equipment. The harmful effects of cold

can be prevented in large measure by the use of proper clothing and the conditioning of personnel. Advantage must be taken of every clear minute to do the things that cannot be done when observation is obscured.

c. The safety or danger of almost all high mountain regions, especially in winter, depends upon a change of a few degrees of temperature above or below the freezing point. The comfort and health of men and animals are affected. Ease and speed of travel are largely dependent on weather. When snow covers the ground, weather determines if wheeled vehicles, tracked vehicles, or animals can operate efficiently. Terrain that can be crossed swiftly and safely one day becomes impassable or highly dangerous the next because of snowfall, rainfall, or a rise in temperature. The reverse can happen just as quickly. The prevalence of avalanches depends mostly on weather factors.

144. CLIMATIC ZONES. The effects of temperature, precipitation, and wind in mountain regions result in several different climatic zones according to the altitude. In the middle latitudes, the valley bottoms may have a grassland-agricultural climate, while the midslopes favor a forest zone, and the summits reach into the alpine climate of low temperature, strong wind and snow.

145. GENERAL CHARACTERISTICS. Mountain weather is very uneven. Hurricane winds and gentle breezes may be found a few paces apart. The weather in exposed places contrasts sharply with the weather in sheltered ones. Weather changes in a single day can be so erratic that in one locality one may experience hot sun and cool shade, chill wind and calm, gusts of

rain or snow, and then intense sunlight again. This variability results from the life cycle of a local storm or from the movement of traveling storms. In addition, the effects of storms are modified by the following local influences:

a. Variations in altitude.

b. Differences in exposure to the sun and to prevailing winds.

c. Distortion of storm movements and the normal winds by irregular mountain topography. These local influences dominate summer storms. During summer the weather fluctuations are at a maximum, although they are less severe than winter changes.

Section II. WEATHER DETERMINANTS

146. TEMPERATURE. a. **Temperature inversion.** Normally, a temperature fall of from 3° F., to 5° F., per thousand feet gain in altitude will be encountered. Frequently, on cold, clear, calm mornings when the march starts from a valley, the temperature increases as altitude is gained. This reversal of the normal situation is called "temperature inversion."

b. **Solar heating.** At high altitudes, solar heating is responsible for the greatest temperature contrasts. More sunshine and solar heat are received above than below the clouds. The important effect of altitude is that the sun's rays pass through less of the atmosphere and more direct heat is received than at lower levels where solar radiation is absorbed and reflected by dust and water vapor. There may be differences of 40° F., to 50° F., between the temperature in the sun and that

in the shade. Special care must be taken to avoid sunburn and snow blindness which result from the combined action of intense sunlight and the reflected rays from snow fields or clouds. Besides permitting rapid heating, the clear air at high altitudes also favors rapid cooling at night. Consequently the temperature rises fast after sunrise and drops quickly after sunset. Much of the chilled air drains downward, so that the differences between day and night temperatures are greater in valleys than on slopes.

147. CLOUDINESS AND PRECIPITATION. a.

Cloudiness and precipitation increase with height until a zone of maximum precipitation is reached; above this zone they decrease. Maximum cloudiness and precipitation occur near 6,000 feet elevation in middle latitudes and at lower levels as the poles are approached. Usually a dense forest marks the zone of maximum rainfall.

b. Slopes facing the prevailing wind are cloudier, foggier, and receive heavier precipitation than those to the lee of the wind, especially when large bodies of water lie to the windward. However, at night and in winter, valleys are likely to be colder and foggier than high slopes. Heads of valleys often have more clouds and precipitation than adjacent ridges and the valley floors.

148. WIND. a. In high mountains the ridges and passes are seldom calm; however, strong winds in protected valleys are rare. Normally, wind velocity increases with altitude, since the earth's frictional drag is strongest near the ground, and this effect is accen-

tuated by mountainous terrain. Winds are accelerated when they are forced over ridges and peaks or when they converge through mountain passes and canyons. Because of these funnelling effects, the wind may blast with more force on an exposed mountainside than on the summit itself. In most cases, the local wind direction is controlled by topography.

b. The force exerted by wind quadruples each time the wind speed doubles; that is, wind blowing at 40 miles per hour pushes four times harder than does a 20-mile-per-hour wind. With increasing wind strength, gusts become more important, and may be 50 per cent higher than the average wind velocity. When wind strength increases to the hurricane speed of 80 miles per hour, men should hug the ground during gusts and push ahead in lulls. If a hurricane wind blows where there is sand or snow, dense drift fills the air, and rocky debris or chunks of snow crust skip along near the surface.

c. In general, the velocity of the winds accompanying local storms is less than that of winds with traveling storms. There are two winds which result from the daily cycle of solar heating. During calm, clear days in valleys subject to intense solar radiation, the heated air rises and flows gently up the valleys. This wind is called a "valley" or "up-valley" breeze. On clear nights the mountainsides lose heat rapidly and cool the surrounding air which settles downslope to produce the "mountain" or "down-valley" breeze. The down-valley breeze, by pouring cold air into a valley, is responsible for temperature inversions, in which the temperature increases with altitude.

Section III. STORMS AND WEATHER TYPES

149. THUNDERSTORMS. a. Although thunderstorms are local in nature and usually of short duration, they can be real handicaps to operations in the mountains. In the alpine zone above timberline, a thunderstorm lashes with driving snow and sudden squally winds. Ridges and peaks become focal points of concentrated electrical activity which are highly dangerous.

b. Purely local thunderstorms develop from rising air columns resulting from the intense heating by the sun of a relatively small area. They occur most frequently in the middle or late afternoon. Scattered fair weather clouds of the cumulus type often appear harmless, but when they continue to grow larger and reach a vertical depth of several thousand feet, they may turn into thunderstorms on very short notice.

c. Thunderstorms striking at night or in the early morning are associated with major changes in the weather situation, which often result in a long period of foul weather before clearing on the high summits. Thunderstorms striking at these times may also be part of a "line storm" and if so, are followed by a prolonged period of cool dry weather.

150. FOG. On windward slopes, persistent fog, as well as cloudiness and precipitation, frequently continue for days, and are caused primarily by the local barrier effect of the mountain on prevailing winds. Any cloud bank appears as a fog from within. Fog limits visibility which, in turn, hampers operations by increasing the possibility of accidents. It also facilitates surprise attacks. If fog is wet or accompanied by precipitation,

additional clothing will be needed for protection against the uncomfortable combination of cold and wetness. When traveling without landmarks, it will be necessary to use a compass and a map, and to keep track of the distance and courses, in order to follow a route.

151. TRAVELING STORMS. a. The most severe weather conditions, storms involving strong winds and heavy precipitation, are the result of widespread atmospheric disturbances which generally travel in an easterly direction. If a traveling storm is encountered in the alpine zone during winter, all of the equipment and skill of the soldier will be pitted against low temperatures, hurricane gusts and blinding snow.

b. Traveling storms result from the interaction of cold and warm air. Although the heart of the storm is a moving low pressure area, the "warm front," which marks the advancing thrust of warm air, and the "cold front" of onrushing cold air are more important features than the center itself, from which they radiate.

c. The sequence of weather events with the approach and passing of a traveling storm depends on the state of the storm's development, and whether the location of its path is to the north or south of a given mountain area. Generally, scattered cirrus clouds merge into a continuous sheet which thickens and lowers gradually until it becomes alto-stratus. At high levels, this cloud layer appears to settle. Lower down, a stratus deck may form overhead. A storm passing to the north may bring warm temperatures with southerly winds and partial clearing for a while, before colder air with thunder showers or squally conditions moves in from the north-

west. However, local cloudiness often obscures frontal passages in the mountains. The storm may go so far to the north that only the cold front phenomena of heavy clouds, squalls, thunder showers, and colder weather are experienced. The same storm passing to the south would be accompanied by a gradual wind shift from north-easterly to northwesterly, with a steady temperature fall and continuous precipitation. After colder weather moves in, the clearing at high altitudes is usually slower than the onset of cloudiness, and stormy conditions may last several days longer than in the lowlands.

d. Glaze is a form of precipitation deposited only under the special conditions found in traveling storms. When light rain or drizzle falls through air below 32° F., and strikes a surface that also is below 32° F., it freezes to the surface in the form of glaze. Glaze usually forms near the warm front of a storm and only persists if colder weather follows.

Section IV. WEATHER PREDICTION METHODS

152. WEATHER FORECASTING. **a.** The use of the portable aneroid barometer, thermometer, and hygrometer can be of great assistance in making local weather forecasts. Reports from other localities, and from the weather service of the air forces, are also of great value.

b. In order to be utilized to its fullest extent, the resulting forecast must get down to the small-unit leaders who are expected to make use of favorable weather for specific missions.

153. CAUSES OF BAD WEATHER. Most of the bad weather experienced in mountain regions is caused by—

a. Local storms in the form of thunderstorms, with or without showers.

b. Traveling storms which may be accompanied by radical and severe weather changes over a broad area. Usually, each type of storm may be identified by the clouds associated with it.

c. Seasonal moisture bearing winds of the monsoon type which bring consistently bad weather to some mountain ranges for weeks at a time.

154. CLOUD TYPES. It is possible to differentiate between local and traveling storms, and estimate their probable occurrence, by recognition of the following cloud types:

a. Cirrus clouds are composed of ice crystals and occur 4 to 7 miles high. They may be detached white clouds with fibrous structure, or they may be extensive thin veils.

b. Alto stratus clouds are dark clouds that form a continuous uniform sheet at elevations from 8,000 to 16,000 feet. They may cover the sky completely and develop from the descending and thickening cirrus or the merging of high cumulus types.

c. Cumulus clouds resemble great patches of cotton or giant heads of cauliflower and form at any height from 1,500 to 7,000 feet. Their bases are flat, but their tops vary in size and height. Cumulus clouds are brilliant white in direct sunlight, but dark on the shaded

side. Alto cumulus clouds are similar in form, but smaller, and appear in uniform layer or cloud deck at 8,000 to 16,000 feet.

d. Cumulo nimbus (thunderheads) are overgrown and darkened cumulus clouds that are yielding, or are likely to yield, precipitation. A single cumulo nimbus cloud mass may extend from a base at $\frac{1}{2}$ mile elevation to a height of 6 or 7 miles.

e. Stratus clouds are similar to alto stratus, but much lower. They may develop from a fog layer in which the bottom portion has evaporated, or where upslope winds are blowing. Often they are associated with moisture precipitation and usually are seen below 3,000 feet, except where they are forced up over a mountain or lie in high valleys.



Figure 29. Cirrus clouds.

155. WEATHER PREDICTIONS. Each of the cloud types characterizes one or several phases in a given weather situation. The following are the most common weather indications, although they are not always applicable. An individual remaining in one mountain region for several weeks in any season can add indications for that area based on his own experience with local weather changes.

a. Traveling storms. The approach of a traveling storm is indicated when—

(1) A thin veil of cirrus spreads over the sky, thickening and lowering until alto stratus clouds are formed. (See fig. 29.) The same trend is shown at night when

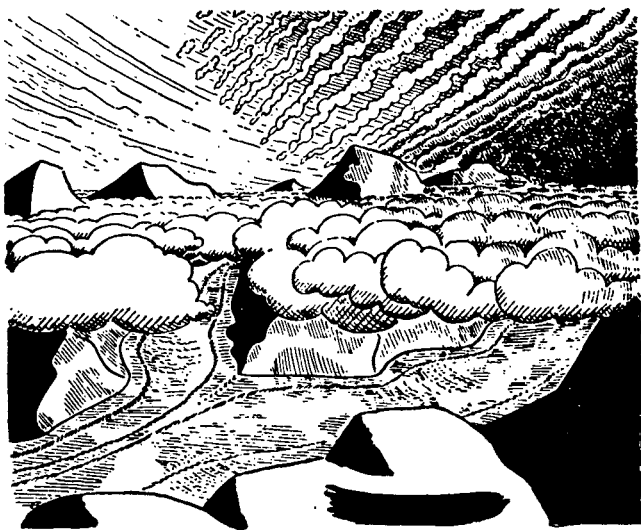

Figure 30. Confused layers of clouds.

a halo forms around the moon and then darkens until only the glow of the moon is visible. When there is no moon, cirrus only dims the stars, while alto stratus hides them completely.

(2) (a) Low clouds which have been persistent on lower slopes begin to rise at the time upper clouds appear.

(b) Confused layers of clouds move in at different heights and become more abundant. (See fig. 30.)

(3) Lens-shaped clouds accompanying strong winds lose their streamlined shape and other cloud types appear in increasing amounts.

(4) A change in the direction of the wind is accompanied by a rapid rise in temperature not caused by



Figure 31. Thickening of scattered cumulus.

solar radiation (Chinook, Foehn wind). This may also indicate a warm, damp period.

(5) An intense green sky is observed shortly after sunrise in mountain regions above timberline.

b. Local disturbances. Indications of local thunderstorms, showers, or squally weather are:

(1) An increase in size and rapid thickening of scattered cumulus clouds during the afternoon. (See fig. 31.)

(2) The approach of a line of large cumulus or cumulo nimbus clouds with an advance guard of alto cumulus. At night, increasing lightning to windward of the prevailing wind gives the same warning.

(3) Massive cumulus clouds hanging over a ridge or summit both at night or in the daytime.



Figure 32. Plumes of blowing snow.

c. Strong winds. Indications from strong winds, seen at a distance, may be:

(1) Plumes of blowing snow from the crests of ridges and peaks, or ragged shreds of cloud moving rapidly. (See fig. 32.)

(2) Persistent lens-shaped clouds, or a band of clouds, over high peaks and ridges or downwind from them.

(3) A turbulent and ragged banner cloud which hangs in the lee of a peak.

d. Fair weather. Fair weather may be associated with—

(1) A cloudless sky and shallow fog or layers of smoke or haze at valley bottoms in early morning; or from a vantage point of high elevation, a cloudless sky



Figure 33. Small cumulus clouds.

that is quite blue down to the horizon or down to where a level haze layer forms a secondary horizon.

(2) Conditions under which small cumulus clouds appearing in the forenoon do not increase, but decrease or vanish, during the day. (See fig. 33.)

(3) Clear skies, except for a low cloud deck which does not rise or thicken during the day. (See fig. 34.)

e. During precipitation. When there is precipitation and the sky cannot be seen:

(1) Very small snowflakes, ice crystals, or drizzle indicate that the clouds above are thin and there is fair weather at high altitudes.

(2) A steady fall of snowflakes or raindrops indicates that the precipitation has begun at high levels and that bad weather is likely to be encountered on ridges and peaks.



Figure 34. A low cloud deck.

CHAPTER 7

WINTER CHARACTERISTICS

Section I. GENERAL

156. REFERENCE. For a detailed description of operations in snow and extreme cold, see FM 70-15.

157. GENERAL CHARACTERISTICS. a. Mountainous regions in cold and temperate zones are characterized during winter by the following:

(1) A great amount of snow, which remains during most of the year in the high regions.

(2) Extreme cold, often reaching 40° or more below zero in some areas, and severe snow storms which impose great hardships on the troops.

(3) Snow starts to fall at varying times in the autumn according to the geographical location, altitude, and exposure. The snow cover differs with the altitude and may also differ greatly from year to year. A deep snow cover greatly changes the problems of living in the mountains, especially by increasing the difficulties of communication, transportation, and sanitation. Even a small amount of snow restricts the movement of men, animals, and vehicles. The deeper the snow, the more it hampers and canalizes the movement of columns. If it is over

a foot deep, movement by foot troops must be accomplished with the aid of skis and snowshoes. Pack animals will be confined to plowed roads and packed trails, and motor vehicles will not be able to proceed any further or any faster than the snow removal equipment will permit. The emplacement of artillery becomes an extremely slow and laborious process. In some cases, it may be necessary to transport the artillery on sleds or specially constructed runners. Prime movers for heavy artillery must be augmented or replaced by caterpillars, tractors, or other track-laying vehicles.

(4) A great many slopes which are easy to negotiate in the summer become difficult and even dangerous to climb in the winter because of frozen and snow covered ground and the risk of avalanches. When winds reach a great velocity, traffic becomes almost impossible. Nevertheless, a great deal can be done to improve traffic conditions. If there is sufficient man-power and mechanical equipment, the principal routes can be kept clear. Snow removal is usually a continuous process because of drifting snow and frequent snow falls.

b. Snowy conditions are met in high mountains at all seasons of the year.

158. EFFECT OF SPECIAL TRAINING AND EQUIPMENT. Small units of mountain troops, specially equipped, can carry out operations in the mountains during the winter, and because of their special training are aided, rather than retarded, by the snow. The importance and effectiveness of winter operations has taken on an added significance since the adoption of special clothing, skis, snowshoes, and track-laying snow vehicles. Such vehicles can be used to haul personnel,

supplies, equipment, and artillery and they are useful for packing the snow. Such specialized equipment makes large scale winter operations in mountains entirely practicable.

Section II. CLASSIFICATION OF SNOW

159. CLASSIFICATION OF SNOW. a. In the preceding paragraphs the terms "snow" and "ice" have been used in a general sense to describe snow or ice forms. In order to clarify the dangers inherent in snow and ice, it is necessary to outline the forms that snow assumes in its transition of glacier ice. Some forms of snow are of considerable benefit to the mountain soldier, others are a source of grave danger. The classifications in table II and the descriptive material on snow in this paragraph should be studied in connection with table III.

b. Snow is classified as *powder snow* and *compact snow*. Powder snow is snow in its early stages and is classified as *new snow*, *settling snow*, or *settled snow*. Compact snow is snow which has passed beyond the stage of settled snow.

c. *New snow* is powder snow that maintains individuality of flakes immediately following its fall. If new snow is dry, it is feathery; if damp, it quickly consolidates into settling, or settled snow.

d. In the Arctic and at high altitudes, new snow not uncommonly comprises two forms: *sand snow* and *wild snow*.

(1) *Sand snow* falls at extremely low temperatures. As its name implies, it is sandy. Skis, sleds, and toboggans slide over it with considerable difficulty.

Table II. Classification of snow.

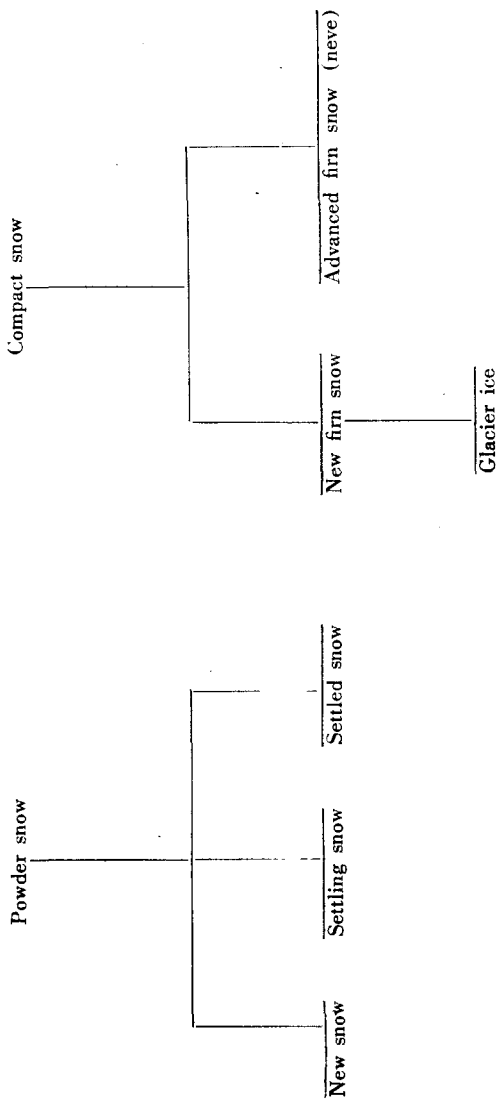

Table III. *Avalanche formations.*

	Type of snow	Composition of snow before dislodgment	Where or when found	Characteristics of avalanche
<p>DRY SNOW AVALANCHES</p>	<p>Wild snow</p>	<p>Extremely light unstable snow with a minimum of cohesion. Skis sink deeply.</p>	<p>May occur on any slope, even in woods. Especially dangerous up to 12 hours after snowfall. May turn into dry new snow avalanche.</p>	<p>Most unstable of all avalanches. May be dislodged by sound. Consists of suffocating clouds of fine snow not confined to channels. Very destructive. Speed may be greater than 100 mph.</p>
<p>(1) Dry powder</p>	<p>Dry new snow</p>	<p>Ordinary dry snow falling at low temperatures.</p>	<p>May occur on any slope greater than 22° for at least 3 days after snowfall, on north slopes for longer periods.</p>	<p>May start gradually or with extreme suddenness. Whole slopes affected. Contains considerable number of snow blocks and is therefore extremely destructive. Speed may be greater than 100 mph.</p>
	<p>Dry settled snow</p>	<p>Fallen dry powder snow in a settled state. Steps kicked easily.</p>	<p>Rare, but may occur on slopes greater than 35°.</p>	<p>Much like dry new snow avalanche but more restricted in areas and contains more blocks. Speed may be greater than 100 mph.</p>

(2) Dry old snow	Closely consolidated granular snow. Steps kicked with difficulty.	Very rare. Generally caused by movements of associated glacier, earthquakes, etc.	Many blocks. High speed.
WET SNOW AVALANCHES	Damp snow	May occur on any slope during light thaw occasioned by sun or foehn wind. Dangerous only when firm anchorage is lacking.	Dislodges as a blanket. Forms large snow boulders. Speed greater than 15 mph.
(1) New, settled snow or old snow	Medium wet	May occur on any slope during thaw. Dislodgment caused by lack of anchorage, human agency, etc.	Commonly occurs in spring. Periodically follows in same courses. Often confined to gullies in lower slopes. May have considerable depth. Very dangerous, but not insidious due to regularity. Speed greater than 30 mph.

Table III. *Avalanche formations—Continued.*

	Type of snow	Composition of snow before dislodgment	Where or when found	Characteristics of avalanche
<p style="text-align: center;">AVALANCHES WIND SLAB</p>	Saturated snow	Runs like mud. Minimum internal cohesion.	May occur on all slopes of greater than 15° during hot sun or rainy weather. Dislodges irrespective of anchorage.	Resembles dry snow avalanche in flow and speed, but is without accompanying cloud. Very destructive.
		Consolidated snow of varying toughness deposited by moist wind. Minimum anchorage to base. Dull, chalky appearance of surface, but may be covered by other snow.	Occurs almost exclusively on lee slopes. May dislodge on gentle gradients.	Characterized by sudden settling of snow and fracture of surface into slabs. Large areas may avalanche. Extremely dangerous because of difficulty of recognition.
<p style="text-align: center;">ICE AVALANCHES</p>		Almost exclusively glacier ice.	On any part of mountain carrying hanging glaciers. Caused largely by movement of the glaciers.	Consists of large blocks that become partly or completely pulverized. It resembles a dry snow avalanche.

(2) *Wild snow* is very dry new snow which falls during complete calms and low temperatures. It is extremely light and feathery and very unstable.

e. *Settling snow* is powder snow consisting of flakes which have begun to lose their individuality.

f. *Settled snow* is powder snow in which the flakes have interlocked and united. This is the *settled powder* to which skiers refer.

g. *New firn snow* is compact, granular snow that is composed of closely associated grains instead of individual flakes. Heat-softened new firn snow is referred to by skiers as *spring snow*.

h. *Advanced firn snow* or *neve* consists of closely associated grains of ice, separated by air spaces.

i. *Glacier ice* is composed of crystals of advanced firn snow cemented by a film of ice. There are no air spaces between the grains and any air spaces present are within the grains themselves.

160. SNOW FORMATIONS. a. The above described forms of snow are subject to various modifications during their transition from dry new snow to glacier ice. Sun, humidity, and wind are important modifying factors in this transition. The following phenomena are important to the mountain soldier:

b. *Sun crust* is any snow the superficial layer of which has been melted by heat and subsequently refrozen. A layer of snow that is sun crusted throughout its thickness becomes firn snow. Sun crust commonly overlies powder snow.

c. *Wind crust or wind-packed snow* is usually found on windward slopes and is anchored firmly to the underlying snow. A moist wind blowing over snow slopes

causes the surface snow to become compacted. Depositing of drifting snow is not involved. Inasmuch as the snow forming wind-packed snow has not been transported, the crystals are not greatly affected by abrasion. Consequently, they reflect much light. *Wind crust is safe.*

d. A *wind slab* is formed from snow transported and deposited by a moist wind. In order for the wind to make such deposit, there must be a decrease in the velocity of the transporting wind. Therefore, wind slabs are found almost exclusively on lee slopes. While the slabs themselves are well compacted, they are loosely anchored to the underlying surface; in fact, all wind slabs have an air space between the slab and the underlying snow. Having been transported by wind, the component grains are rounded and do not reflect the light. For this reason the surface of a wind slab has a dull, chalky appearance. *Wind slabs are extremely dangerous.*

Section III. AVALANCHES AND CORNICES

161. CAUSES OF AVALANCHE. **a.** The danger of avalanches is an item which must be given careful consideration. Avalanches occur when the weight and the pressure of the snow overcome the power of resistance and friction of the under layer, or when the tension in the snow cover is disturbed. The chief influences which have a bearing on the starting of avalanches are the composition and slope of the under layer, the composition of the snow, and the thickness of the snow cover.

b. Boulders, shrubs, trees, and especially woods tend to keep avalanches from forming. Bushes hold the snow

back only when they are not completely buried. Their elastic branches later favor avalanches because of counterpressure. The exact angle at which the snow may slide off in avalanches is hard to determine. There is doubtless avalanche danger on a 24° slope under certain conditions such as smooth ground, grass, and hard snow. A convex surface is much more likely to avalanche than a concave one.

162. TYPES OF AVALANCHES. a. Avalanches are classified according to the type of snow of which they are composed, as follows:

(1) New snow.

(a) Dry, new snow, or powder snow. (See fig. 35.)

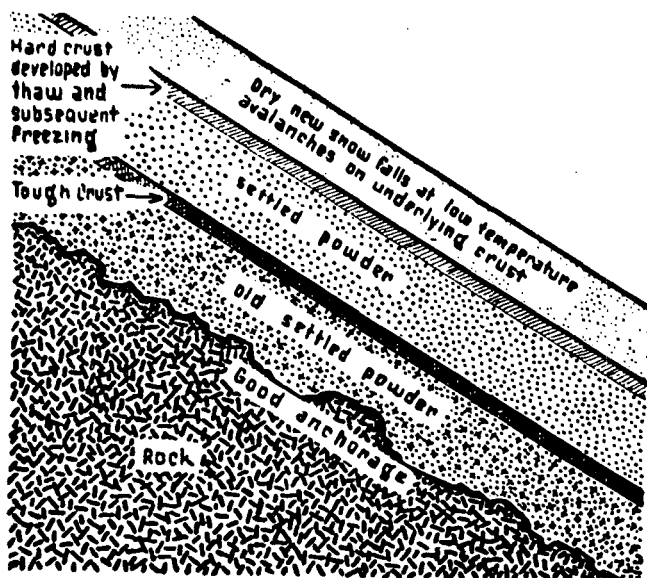

Figure 35. Dry snow avalanche—composition of snow layers.

(b) Wet, new snow. (See fig. 36.)

(2) Old snow or wet spring snow.

b. Dry snow avalanches are the most dangerous. The snow is powdery, fine-grained, loose, fluffy, and dry. It does not pack well. The farther it slides, the more snow it picks up. A very strong gust of wind rushes ahead of the falling avalanche, usually with such power that houses are swept away and woods laid flat. Powdery snow avalanches occur most often in the winter after a snow fall and a rapid drop in temperature. Even during a *long* period of extreme cold, there is a danger of avalanches occurring after a heavy fall of *new* snow. In high mountains these avalanches must be considered likely during cold weather at every season of the year.

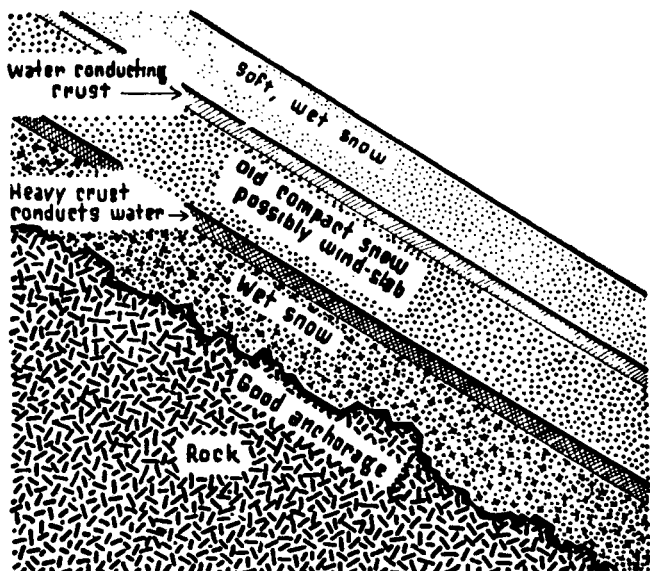

Figure 36. Wet snow avalanche—composition of snow layers.

(1) Snow cushion and wind-slab avalanches belong to the class of powdery snow avalanches. The wind plays an important part in stratifying the snow. Snow rarely falls in high mountains during calm weather. The wind drifts the snow flakes across the ridges. On the leeward side, huge masses of loose snow come to rest. Loose snow is blown out from the summits in long streamers even in fine weather, so that the windward slopes become rock hard and can usually be climbed only with crampons. If the leeward slope is entirely covered with loose snow, there is danger of avalanches. If only small portions of the slope are covered with dry snow, they are known as snow cushions.

(2) Wind slab avalanches occur most commonly on slopes or on the ridges where the wind can drift the very fine powdery snow onto an old, firm underlayer of snow and harden it to a great extent. The most dangerous feature of a wind slab avalanche is that it gives a false impression of solidity because of the hard surface overlying uncompacted snow, or air pockets. It settles suddenly with a dull crack as soon as it is weighted, or even as soon as it is cut by the sharp edge of a ski. The whole slope breaks off on a definite line more or less straight across the slope, and the snow breaks up in cracks and angular blocks which slide, shoved beside and over each other, rush towards the valley and, according to the slope, either remain as blocks or turn into powder snow avalanches.

(3) Slopes with snow cushions and wind slabs must be crossed with the greatest care. If the ice-ax can be forced through the crust into the deep, soft snow below, it is a snow cushion. The breaking up into small blocks with a definite cleavage across the slope indicates a wind

slab. No slope which appears to be a wind slab should be approached from below. Traversing such a slope is even more dangerous. When the dull sound of the settling snow mass is heard, it is usually too late to withdraw.

c. Wet or damp new snow avalanches, which contain snow that packs well because of its moisture, settles fast, and starts sliding because of its weight, occur when wet snow falls and is worked on by sun and wind. Changes in weather conditions, warm or southerly storms, and rain, favor their starting.

d. Old snow or ground avalanches are composed of wet, heavy compacted, granular firn snow. Warm winter rain, strong sunshine and, in the spring, melting snow start snow masses moving. They usually come down in existing gullies and hollows. In the spring they occur with great regularity in the same spots. These avalanches are less dangerous for the climber, since they can be forecast from the weather and the peculiarities of the locality. Great caution must be exercised on avalanche slopes. These sometimes appear safe, but should never be trusted, as a fall may be fatal.

163. SAFETY RULES. The following rules of conduct should be adhered to whenever it becomes necessary to negotiate a slope that threatens to avalanche:

a. Avalanche cords should be worn. These are brightly colored cords about 65 to 100 feet in length, one end of which is tied around the body while the other drags behind. These facilitate rescues of buried persons because the cord ordinarily remains near the surface.

b. Distance between climbers should be kept accord-

ing to the danger zone. Visual contact is necessary at all times.

c. Buried persons should be searched for systematically. Rescuers should line up across the slope about 6 feet apart. They then move up or down the slope in a line looking for signs of the victim sticking out of the avalanche snow, especially on the perimeter. If nothing is seen they descend (or ascend) probing with avalanche probes (10-foot rods) or ski poles. If nothing is found, parallel trenches at 6-foot intervals are dug as shown in figure 37. The snow beneath and between the trenches is also probed. The time element is important. The man when found should be given artificial respiration.

d. Slopes are traversed more safely high up under the cliffs at the top of an avalanche slope in deep, well-

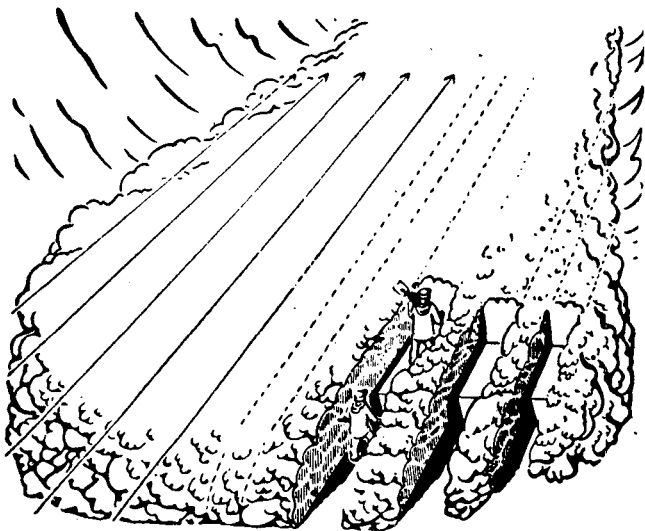

Figure 37. Method of avalanche rescue.

packed steps with the ice-ax well driven in on the uphill side. Steep hollows and gullies should be crossed one at a time. Avalanche slopes should be ascended directly uphill without traversing, preferably along the line of the greatest number of obstacles to the avalanche, such as rocks and trees.

e. When caught by an avalanche, one should keep the feet high, and the head up, and attempt to remain on the surface by the use of swimming motions. Avalanches are more dangerous for a skier than for a climber on foot because the skis drag the skier down to the bottom of the snow. Crossing dangerous slopes on skis or snowshoes disturbs the equilibrium of the snow and causes it to slide more easily. For this reason it is advisable to remove the skis and have the men ascend or descend straight up and down the slope. Falls should be avoided on slopes where avalanche dangers exist.

f. Slopes along supply routes may be cleared of avalanche snow. This can be done by use of mortar fire or grenades at the point where the snow is in greatest tension. A skier, belayed from above, can stamp off the avalanche.

164. AVALANCHE FORMATIONS. Figures 38, 39, and 40 illustrate different types of slopes and avalanche formations. (See also tables II and III.)

a. Figure 38 shows two avalanche slopes separated only by a narrow stream. The brook X can undermine the snow so that avalanches may come from both sides. An individual moving along the valley bottom may precipitate avalanches from either side. There is no possible means of escape.

b. Due to the fact that the snow is disturbed by the

man moving at *Y* (fig. 39), an avalanche starts above this point. It falls to the valley, colliding with the moraine. This is also an extremely dangerous type.

c. An avalanche caused by the man moving at *Z* (fig. 40) brings down the snow above which runs out onto the wide valley floor. The chances for escape or rescue are comparatively good.



Figure 38. Danger of double avalanche.

165. CORNICES (fig. 41). Cornices, which develop during stormy and windy snow falls, are snow formations built out from ridges and the edges of plateaus to a length of many feet. They should never be stepped on, since they break off easily and fall down the steep slopes often starting avalanches. Cornices are hard to recognize from the windward side. Whenever it is likely that one



Figure 39. Danger of avalanche against moraine.

exists near the top of a ridge, the snow should be carefully tested and probed with the ice-ax or ski pole. Under no circumstances should one advance to the very edge to test it. In most cases, a cornice can be avoided. If it must be crossed, this should be done only by someone who is belayed with a rope. It is often possible to

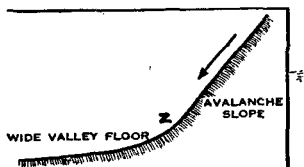
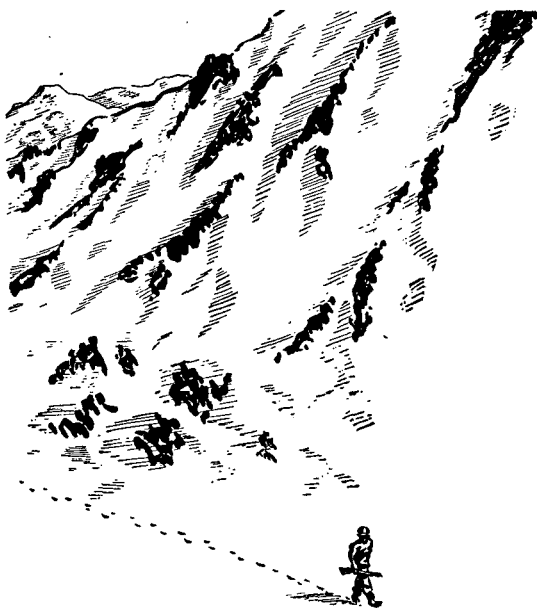

Figure 40. *Avalanche running out in wide valley, less dangerous.*

chop a way through a cornice from below without too much danger. Walking under cornices must be avoided, especially when the wind or sun is strong. When a plateau edge or ridge has a zig-zag shape, there is particular danger from the cornices at the places where the angle changes. If forced to negotiate a cornice, individuals must keep far enough from each other so that a minimum number of casualties will result if it breaks and falls.

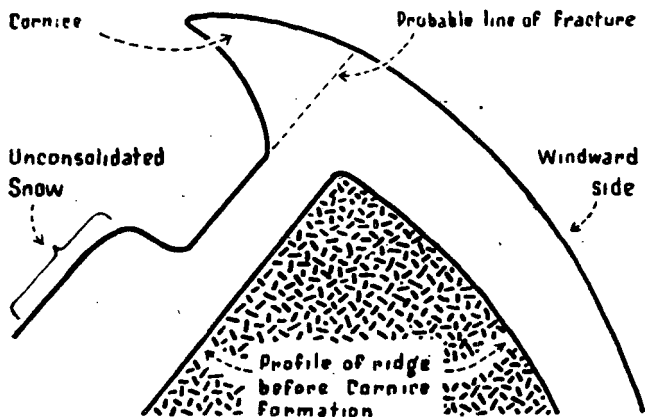

Figure 41. Cornice.

Section IV. MOVEMENT OVER SNOW AND ICE

166. GENERAL. a. Movement over snow with the aid of skis and snowshoes is discussed in detail in FM 70-15.

b. The principles which apply to movement over rocky terrain also apply to oversnow travel when skis or snowshoes are not used. Where snow lies over a founda-

tion other than glacier ice, and the terrain is not steep, no special techniques are called for. Efficient progress depends largely upon proper route selection and on using such procedures as minimize exertion. Rock climbing requires gymnastic agility, combined with good judgment in selecting a safe and direct route. Snow and ice movement makes few gymnastic demands, but a leader needs a greater degree of experienced judgment than he needs on rock.

167. MOVEMENT OVER SNOW AND ICE. a.

On very steep slopes in deep snow, the climber may climb straight up facing the slope. The ice-ax driven directly into the snow provides a quick and effective protection in case of a slip. It is usually best, however, to climb snow slopes in a zig-zag fashion in order to conserve strength. If the snow is hard frozen firm, boot nails will hold until the slope becomes really steep, and even then small steps are often adequate. Where it is difficult to make an effective scrape with the boot, a scrape with the adze end of the ice-ax makes an effective step.

b. When descending in snow, one can usually come straight down even in steep terrain. Movement downhill should be slow and deliberate and with an even pace. The heels should be kicked vigorously into the snow wherever it is hard packed. The body may be kept erect with the help of the ice-ax, which may be jammed into the snow at each step for additional safety.

c. Step-cutting in ice is done with the pick end of the ice-ax. In cutting snow ice a blow directly in and another diagonally toward the first will usually fashion a rough step which may be finished off with the adze end of the

ice-ax. Water ice is harder and requires more blows. The blows should be directed into the ice at as near a right angle as possible to reduce the danger of flaking off the outside layers. The step should slope slightly inward. It does not need to be commodious except at resting places. In climbing steps may be cut straight up or on a diagonal line of ascent. In descending it is seldom practicable to do anything except to cut steps in a diagonal line. Handholds are necessary where the ice face is steep and some method must be used to prevent the body from swinging out.

d. Use of crampons greatly facilitates ice and snow climbing. Balance is very important and the ankle should be flexed so that the crampon points are at right angles to the slope. On hard snow the points of the crampons will bite easily, but on ice the foot should be stamped down hard to drive the spikes in.

e. Belays are more difficult to secure on ice and snow than on rock but they are equally necessary. In general they are obtained by use of the ice-ax, although pitons are sometimes used; for rappelling a belay can be cut directly into the ice itself.

f. On hard packed snow slopes which can be seen from top to bottom and which are not too steep, it is possible to glissade. (See fig. 42.) Glissading should not be attempted unless the bottom of the slope can be seen, otherwise, unseen obstacles may result in serious falls. Glissading in a sitting position is always dangerous. In the standing position, the body must always be kept erect, as nearly upright as possible, and with the ice-ax firmly held in the hands. The ice-ax is pressed back into the snow when necessary. Turning the toes to one side or the other changes the course of descent. Turning sharply

to the side on which the ice-ax is held increases the pressure on the ice-ax and brings one to a stop. To slow down, pressure on the ice-ax is sufficient. Glissading down solidly frozen ice slopes is dangerous, and should not be attempted.



Figure 42. Glissading.

Section V. DANGERS OF GLACIAL REGIONS

168. PRINCIPAL DANGERS. a. The principal dangers of glacial regions are crevasses, ice-falls, and ice avalanches.

b. Glacial crevasses make movement on a snow covered glacier very treacherous. In winter, when visibility is poor, the difficulty of recognizing them is increased. Toward the end of the summer, crevasses are broadest and are covered by the least snow. Snow bridges constitute the greatest potential danger in movement over glaciers.

c. In a steep pitch of a glacier, ice pinnacles and towers rise amid a composition of criss-cross crevasses. These break off and fall because of gradual melting, their own weight, and the movement of the glacier. Ice avalanches result and often threaten men at the foot of ice and rock cliffs. The greatest dangers lie in the gullies below hanging glaciers. Such threatened zones must be crossed as fast as possible and are safer before sunrise.

d. Light and heat rays reflected from ice, snow, water, and bright rocks irritate and burn the skin very rapidly, causing glacial sunburn. Sunburn can occur on cloudy days. A strong wind will make the burn more severe. Before making a long march on snow or glaciers, the face should not be washed with soap and water, but rubbed with an acid-free salve such as lanolin. Men should not shave. It is particularly dangerous to expose parts of the body which are not accustomed to the sun's rays. As soon as any part of the body becomes burned, it should be protected from further exposure. Particularly bad cases of burn very often lead to fever and also to a lessening of muscular activity. It may often take several days before the casualty is fit for duty.

e. Snow blindness occurs when snow is shining brightly on an expanse of snow, and is due to the reflection of ultraviolet rays. It is particularly likely to occur

after a fall of new snow, even when the rays of the sun are partially obscured by a light mist or a fog. In most cases, snow blindness is due to negligence or failure on the part of the soldier to use his goggles. Symptoms of snow blindness are a sensation of grit in the eyes, pain in and over the eyes, watering, redness, headache, and photophobia (distaste for light). Pontocain or butyn ointment and zinc sulphate drops are the prescribed treatment for snow blindness. A poultice of cold used tea leaves may be used to give relief if the drops are not available. Dark eye shades or bandages should be placed over the eyes.

Section VI. MOVEMENT OVER GLACIERS

169. USE OF ROPE (fig. 43). A roped party of two, while ideal for rock climbing, is at a great disadvantage on a snow-covered glacier, since it is almost impossible for one man alone to rescue another who has fallen into a crevasse. The best combination is a four-man party, two teams of two men each, tied in on a single rope. The rope interval between members of the party need not exceed 30 feet, but a party moving over a snow-covered glacier must maintain almost the full rope interval at all times. However, each member should carry in a coil enough of the intervening rope to eliminate a direct pull on his body loop. The rope should touch the snow as little as possible, since a wet rope kinks badly and may freeze and become unmanageable. It is best to travel roped at all times when on the snow-covered part of a glacier. At times, it may be desirable to use the rope on the snow-free part also.

170. ROUTES. a. The courses followed by glaciers provide natural avenues of movement, just as do river valleys. The mountain soldier must appreciate the limitations imposed by nature on glacier movement.

b. Access to the surface of the lower part of a glacier may be easy or it may be extremely difficult depending upon the abruptness of the margins and the numbers of crevasses in the ice. The transition from moraine to glacier ice is often so gradual that no difficulty is encountered, but in other places, an ice cliff or crevasse may bar progress. Where margins are steep, steps may have to be cut with the ice-ax. However, before this is done,



Figure 43. Method of carrying rope coil when moving on glaciers.

a search should be made for a shallow crevasse that cleaves the margin and has a bottom which slopes up to the surface.

c. Access to the upper part of a glacier is often easier than to the lower part. Not only are the margins in the upper part likely to be less abrupt, but fallen rocks and the remnants of snow avalanches often provide bridges to the surface.

171. CROSSING CREVASSES. a. Crevasses which gape wide open are obvious, and their presence is an inconvenience rather than a danger to movement. Narrow cracks can be jumped, provided the take-off and landing spots are firm and offer good footing. Wider cracks will have to be circumvented unless a solid piece of ice joins the two lips and is strong enough to support the weight of the party. Such pieces of ice may occur below the glacier surface, and may run diagonally across the crevasse.

b. In the zone that divides seasonal melting from permanent falls of snow, large crevasses remain open, though their depths may be clogged with masses of snow. Narrow cracks may be covered. In this zone, the snow which covers glacier ice melts more rapidly than that which covers crevasses. The differentiation between glacier ice and narrow, snow-covered cracks is immediately apparent, for the covering snow is white, whereas the glacier ice is gray.

c. Usually, the upper part of a glacier is permanently snow covered. The snow surface here will vary in consistency from dry powder to consolidated snow. Below this surface cover of snow are found other snow layers that become more crystalline in texture with depth, and

gradually turn into glacier ice. It is in this snow-covered upper part of a glacier that crevasses are most difficult to detect, for even wide crevasses may be completely concealed by snow bridges.

d. Snow bridges are formed of windblown snow which builds a cornice over the empty interior of the crevasse. As the cornice grows from the windward side, a counterpart is formed on the leeward side. The growth of the leeward portion will be slower than that to windward so that the juncture of the two cornices occurs over the middle of the crevasse only when the contributing winds blow equally from each side of the crevasse. Bridges can be formed also without wind, especially during heavy falls of dry snow, and since cohesion of dry snow depends only on an interlocking of the branches of delicate crystals, such bridges are particularly dangerous.

e. Once a crevasse has been completely bridged, its detection is difficult. (See fig. 44.) Bridges are generally slightly concave because of the settling of the snow, and this concavity is perceptible in sunshine, but impossible to detect on dull days or during a snow storm. If the presence of hidden crevasses is suspected, the leader of a roped party must probe the snow in front of him with the shaft of his ice-ax or with some similar instrument. As long as a firm foundation is encountered, the party may proceed, but should the shaft meet no opposition from an underlying layer of snow, a crevasse is probably present. In such a situation, probe closer to the standing place to make sure that the party is not standing on the bridge itself. If so, retreat gently from the bridge and determine the width and direction of the crevasse. Follow and probe the margin until a more resistant portion of the bridge is reached. When moving

parallel to a crevasse, all members of the party except the leader should keep well back from the edge, and follow a course parallel to that of the leader.

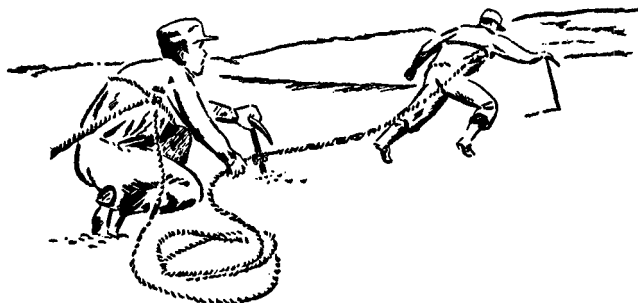

Figure 44. Probing for a crevasse.

f. A crevasse should be crossed at right angles to its trend unless a diagonal bridge is clearly visible. When a bridge which seems sufficiently strong to hold a member of the party has been located, proceed as follows:

(1) The leader and second man take up positions at least 10 feet back from the edge of the crevasse. The third man stands the full rope distance behind the second man.

(2) The second man belays the leader by plunging the shaft of his ice-ax firmly into the snow surface, taking a loop around it with the rope, and paying out line as the leader advances. If the snow is too powdery to provide a good anchorage for the ice-ax, the second man should sit in the snow with his feet braced in front of him, and use the hip belay prescribed for rock climbing.

(3) The leader should move forward, carefully probing the snow and evaluating the strength of the bridge, until he reaches firm snow on the far side of the crevasse.

(4) Having crossed the crevasse, the leader should belay the second man in the same manner as described in (2) above.

(5) When the second man has crossed safely, the leader should move forward to a secure position while belays are provided for remaining members of the party by each succeeding climber.

(6) In case the rope interval is insufficient for the leader to reach firm snow, the second man must unrope, undo the knot, and have the third man move up to a position which will allow the leader to reach a secure position.

g. In crossing crevasses, distribute the weight over as wide an area as possible. The use of skis or snowshoes is recommended for this purpose. If afoot, glide the feet into position. Do not stamp the snow. Many fragile bridges have been crossed by lying down and edging over to the other side.



Figure 45. Belaying a leader who has fallen through a snow bridge.

172. CREVASSE RESCUE. a. A fall through a snow bridge results either in the climber's becoming jammed in the hole broken by his feet, or in being suspended within the crevasse by the rope. (See fig. 45.)

b. If the leader has fallen only partially through the snow bridge, he is supported by the snow forming the bridge. He should not thrash about. This will only enlarge the hole and will result in deeper suspension. All his movements should be slow and aimed at rolling out of the hole and distributing his weight over the remainder of the bridge. Pulling on the rope with one or both hands is of great assistance. The victim can help himself more than he can be helped by the second man, whose duties consist primarily of belaying the rope firmly to check any further break-through on the leader's part. It generally is safer to retain the pack, as its bulk often prevents a deeper fall. Discarding the pack may mean its loss if a larger break-through occurs. Should a climber other than the leader experience a partial fall, the rescue procedure will be the same as for the leader.

c. (1) When the climber is suspended by the rope, the length of his fall depends upon how quickly the rope can be checked and where in the bridge the break takes place. If the fall occurs close to the near edge of the crevasse, it usually can be checked before the climber has fallen more than 5 or 6 feet. However, if he is nearly across, the fall will cause the rope to cut through the bridge, and then even an instantaneous check by the second man will not prevent a considerable fall.

(2) In such a fall, it is necessary to act promptly to relieve the constriction of the loop around the victim. The victim can ease the strain by lifting himself on the rope, but he can do so for only a very short period,

during which time those on the surface must ascertain the conditions existing in the crevasse. For example, where firm masses of snow clog the crack some distance below the surface, it is easier to lower the victim to such a platform and begin rescue operations from there. In estimating the conditions within the crevasse, it should be remembered that it is almost impossible to hear the voice of the victim even a short distance from the hole through which he fell. Therefore, one member of the party, while belayed by another, must approach the hole in order to gain the required information.

d. (1) Since a snow bridge is usually strongest at the edge of the crevasse, a fall is most likely to occur some distance away from the edge. In such places, the rope usually bites deeply into the snow, thus greatly increasing friction for those pulling from above. In order to reduce friction, place an ice-ax or ski under the rope and at right angles to the stress. (See fig. 46.) If a ski is used, place the running surface down so that the rope will not cut on the edges. Push the ice-ax or ski forward as far as possible toward the edge of the crevasse. If the victim is able to reach firm footing within the crevasse, and thus relieve the strain on the rope, the support may be placed at the most advantageous point.

(2) Whether or not the victim is able to reach firm footing within the crevasse, the rescue procedure remains essentially the same. A spare rope is of great value. If none is available, as many members of the party as necessary will have to unrope to provide sufficient rope to reach the fallen man. The simplest and quickest procedure is to lower the loose end of this rope until he can reach it; it then is securely belayed on the surface. While he is being pulled up he aids himself by pulling

himself up on the anchored rope. His progress is aided by the rescuers' taking up the body line.

e. An alternate procedure is to tie a nonslipping noose at the end of the fixed rope and let it down to the fallen man. (See fig. 47.) He passes it inside his body loop, and down to a level where he can place one or both feet in the noose and stand erect. By slackening the body



Figure 46. Ascending from crevasse on a fixed rope.

line in this way, it can be taken in and made fast by the belayer. The fallen man then places his weight on the body line while the foot loop is raised from above and made fast. An upward step is thereby provided for him. By a repetition of these operations, he approaches the lip of the crevasse. If an overhang is encountered here, the best procedure is for him to grasp the fixed



Figure 47. Ascending from crevasse by means of foot on fixed rope.

rope, place both feet against the snow or ice of the crevasse wall and "walk" out over the overhanging snow while the slack on the body line is taken in and belayed from above.

f. If the suspended man is unconscious or otherwise injured by his fall, it may be necessary for another member of the party to descend below him and, by means of the procedure outlined above, lift the fallen man on his shoulders. This procedure requires a doubling of the fixed rope. The descent may be made by the rappel technique used in rock climbing, or a man may be lowered from above. In either case, a stirrup loop must be tied in the end of the doubled fixed rope for use in raising the rescuer, and with him the injured man. The successful accomplishment of this maneuver depends in large measure upon the skill of those belaying and taking in slack from above. There are three ropes that require careful manipulation: The body line of the victim, the body line of the rescuer, and the doubled fixed rope. If possible, more than one man should participate, one to belay and take in slack on the two body lines, the other, alternately to raise and belay the doubled fixed stirrup rope. Do not haul an injured man if his injuries are likely to be aggravated by such procedure unless the safety of the entire party would be jeopardized by having a member of the party descend into the crevasse.

g. Usually a leader who has been extricated from a suspended fall should not be permitted to resume immediately the responsibility of route selection. A free fall of only a few feet and the resulting rescue operations are a severe strain on a man, and may even result in shock.

Section VII. SPECIAL CLOTHING AND EQUIPMENT

173. GENERAL. Winter operations in snow-covered mountains in the temperate, as well as in the frigid zones, require the use of special clothing and equipment. It is important that troops be thoroughly indoctrinated and trained in the proper use, care, and maintenance of such special clothing and equipment in order to derive the maximum benefit therefrom. These subjects are discussed in detail in TM 10-275 and FM 70-15.

CHAPTER 8

ADMINISTRATION

Section I. MOTOR TRANSPORTATION

174. GENERAL. a. Reconnaissance of the available road net will usually determine the type and the maximum number of trucks that can profitably be employed in any particular mountain operation. Most of the heavy type motor trucks are roadbound and limited to improved roads. Mountain roads or trails usually are unimproved. Bridges are often narrow and of a flimsy construction and require reinforcement before they are adequate for military traffic. Few roads are built on ridges where troops will operate.

b. Motor transportation in mountainous terrain must be drastically reduced. Only those trucks carrying loads which cannot be packed should be allowed beyond a previously designated truckhead. Only prime movers and $\frac{1}{4}$ -ton trucks should be taken into combat. The list of trucks to be left behind, which may average two-thirds of the total, should be part of the standing operating procedure of each unit. When the mountains have been crossed and the road net branches out, the trucks left behind can be brought forward under convoy.

c. Full advantage must be taken of motor transporta-

tion to move ammunition and rations as far forward as possible during hours of darkness in order to reduce the high percentage of combat personnel required for packing and hand carry.

d. Motorized reconnaissance may be advantageously employed in the large valleys. Light combat vehicles can render excellent service in screening, pursuit, and attack against the enemy flank.

e. Demolished vehicles, when properly placed, make very effective emergency roadblocks.

175. TRAFFIC CONTROL. Traffic control must be rigidly maintained to prevent traffic congestion and delay. The responsibility for establishing and maintaining traffic control must be delegated to one person within the battalion or larger unit. Telephones should be installed to control traffic on long stretches of one-way road. Traffic jams can be largely avoided if the following precautions are taken: establishing a block system for one-way roads; granting of priorities to loaded ammunition trucks and ambulances; preventing turn arounds except on places especially prepared and designated for that purpose; requiring troops to march off the roads. When trucks must pass each other on a narrow road, the one on the safer side should move forward only after that on the more dangerous side has pulled over as far as possible and has come to a full stop.

176. MAINTENANCE. a. Maintenance of motor transportation assumes unusual importance in mountain operations. Prior to and during operations in steep terrain, the safety devices of all vehicles must be checked continually, since failure on the part of any may have

disastrous results. Proper adjustment of brakes is especially important. The emergency brake must be adjusted so that it is capable of holding the vehicle on any slope without the aid of gears or foot brakes. One failure which is extremely dangerous when vehicles are descending steep slopes and depending on the braking power of the engine is the slipping out of gear of the transmission. Winches should be checked for proper lubrication and proper adjustment of the automatic brake.

b. For information on special care of equipment in extreme cold, see FM 70-15 and appropriate technical publications.

177. MOVEMENT ON STEEP GRADES. a. Steep grades are constantly encountered in mountainous terrain. All grades should be negotiated, as far as possible, by driving; winching should be considered a last resort. Chains are frequently necessary due to the presence of ice or mud on the road surface.

b. Short, steep pitches may be climbed by building up momentum in the approach. Generally, however, steep grades should be approached with a slow, steady pull; when this procedure is followed, the vehicle will normally go higher before traction fails and winching must be resorted to. When winching is necessary, the route selected should provide frequent anchor points in the form of trees or rocks. The more frequently anchor points are used, the greater the mechanical advantage that can be obtained by the use of snatch blocks. When trees or rocks are not available, the ground-anchor can be used. At each point where winching is necessary, the use of one prime mover to winch other vehicles or howitzers in turn as they arrive at that position is recommended.

When howitzers are being winched up or down, the trails of the weapons should be downhill. When winching on steep slopes, less strain is placed on the winch if the gear of the vehicle being winched is placed in neutral, and the winch allowed to pull steadily. The power on the winch must not be released too suddenly, as this places undue strain on the cable. Care must be taken at all times to clear obstructions from the route in front of the wheels.

c. When there is sufficient traction, prime movers with howitzers in tow can be driven down most grades. The vehicles should be placed in lowest gear. A man with a large chock, stationed beside each wheel of the truck and howitzer, provides emergency stoppage for the vehicle. Two men should apply the howitzer brakes, keeping them as tight as possible, but not letting them skid the wheels. A rope should be fastened to the uphill end of the howitzer to prevent it from "jack-knifing."

d. When the ground becomes too slippery or the grade too steep to provide traction, all prime movers and howitzers must be lowered by block and tackle or winch. In lowering by winch, care must be taken to see that the automatic brake does not overheat. Slow operation of the winch, and proper adjustment of the automatic brake will prevent this. In all descents and ascents, wet weather, and not the steepness of the grade, will be the limiting factor.

178. DAYLIGHT DRIVING. In daytime driving on mountain roads, all vehicles should normally remain in open column because of their vulnerability to air attack. Extreme care must be exercised on all roads because of the many sharp, blind curves and steep grades. All curves

must be taken at a speed which will enable the driver to halt the vehicle in half the visible road space. Either up or downhill grades should be taken in a gear ratio that will enable the vehicle to take the entire hill without shifting. *Caution must be exercised to see that the speed of the vehicle does not exceed two-thirds of the speed (listed on the chart in the cab of the vehicle) for that particular gear ratio. Hills should be descended with a combination of braking and engine. Neither should be used alone to bring a vehicle downhill.* On routes where pioneer work must be done before the vehicles of the organization can pass, a pioneer group under an officer, consisting of one prime mover with trailed load and sufficient personnel and pioneer equipment, should precede the column by several hours. Guides should be posted at dangerous places, especially when backing and turning are required, to give directions to each driver just before he starts to negotiate the difficult section.

179. DRIVING AT NIGHT. Because the danger of blackout driving in mountains will often exceed the danger of enemy action, driving without lights on narrow winding mountainous roads should be held to a minimum. When blackout driving is necessary because of enemy observation it should be limited to those stretches of road visible to the enemy. At these points signs and guides should be posted to give special instructions to each driver as he approaches. Trucks should be in close column. Only when the driver can definitely see the road or the tail light of the vehicle in front is it safe to drive without an assistant driver preceding on foot. Lead vehicles should not exceed 5 miles per hour.

Section II. ANIMAL TRANSPORT

180. USE. a. Pack trains are used beyond the point where motor transport can go; in some instances, depending on the terrain and road net, they are used exclusively. This type of transport increases in value and necessity in direct proportion to the scarcity or poor condition of roads.

b. Quartermaster pack troops (companies) are normally assigned to tactical units and installations along supply and evacuation routes. Mules of the pack troops (company) are trained for herd operation by platoons. When operating with infantry, engineers, and medical units, the mule leaders are provided by the units to which the pack troops (companies) are attached.

c. A minimum of 300 mules per infantry division is required in the mountains where motor vehicles can operate on improved roads. Where no roads are available 1,200 mules per regiment may be needed. Short distances require fewer mules because more trips per day can be accomplished. Mules become fatigued more rapidly in mountainous terrain and care should be taken not to destroy their usefulness by overwork.

d. All mules operating with infantry, engineer, or medical units must be trained to hand leading. Training in animal management and pack transportation is necessary for all infantry, engineer, and medical personnel. Animal management and similar subjects are discussed in FM 25-5; pack transportation is treated in FM 25-7.

e. Without mules, the burden of resupply falls on the individual soldier, and to utilize combat troops as porters tends to defeat their purpose.

f. The average pay load for American mules is approximately 200 pounds. Since Class I requirements are $\frac{1}{2}$ ton per day infantry battalion, and Class V requirements, 5 to 6 tons per day per infantry battalion in active combat, a section of 50 to 65 mules per infantry battalion would be required for sustained action, if animals are not used to pack weapons. When animals are used to carry all weapons, equipment, and supplies, 100 to 150 mules will be required. If inferior mules or donkeys are employed, the number of animals required will be increased because of the decreased load capacity of the individual animal.

g. In addition to the supply mules, there should be at least 24 mules per front-line battalion for the evacuation of wounded and resupply of medical equipment. These mules should be carefully selected and trained to hand lead. One mule can carry one seriously wounded (litter case), or two casualties who are able to maintain their balance and ride upright.

181. MARCHES. **a.** A loaded mule's pace is very different from that of a man. It will climb faster than a man with a pack, and descend more slowly. On normal mountain paths a mule can climb at the rate of 1,650 vertical feet per hour and descend at the rate of 1,000 vertical feet per hour. When descending, a mule is extremely careful. It looks over the place where it will place its foot and tries to lessen the shock of the load by taking short steps.

b. Since columns of men and mule trains have different rates of march, each should use different paths so that they will not have to walk with an unnatural pace. If this is not possible, and the tactical situation permits,

the mules can be placed at the head of the column when climbing, and at the rear when descending. A mixed column should always adopt the march rate of the slowest element.

c. A mule leader should walk beside the animal's head on the downhill side of the path traversing a slope or along the edge of an escarpment. The mule has an instinctive tendency to walk on the inside edge of the path as far from the downhill side as possible. During halts, the mule is led off the path and placed with its head towards the downhill slope. If the mule were stopped with its head towards the uphill slope, it might draw back off the path and fall down the slope or cliff.

d. Pack trains should avoid steep grassy slopes without trails, as they are very slippery. Slopes covered with loose rock or gravel and areas covered with sharp rocks or boulders are dangerous and should also be avoided.

e. Pack trains are very vulnerable to air attack and ambush and must be provided with adequate security both on the march and in bivouac. Since the enemy will frequently have excellent observation overlooking all forward valley roads and trails, pack trains must usually work at night or during periods of low visibility.

182. CARE. a. Mules working in the mountains for an extended period must receive ample forage. This should average 10 pounds of oats and 14 pounds of hay per day. These figures can be reduced to one-third for periods up to 10 days without materially reducing the efficiency of the animals. When mountain grazing is possible, these figures can be further reduced.

b. Pack saddles should be provided with a breast band. On particularly steep descents, the girths should

be checked for snugness to make sure that the load does not slip forward.

c. A veterinary officer should always accompany the larger detachments. The rigors and hazards of mountain operations make it imperative that veterinary officers be physically capable and hardened and that they have considerable experience and special knowledge of mountain conditions and their effect on pack animals.

d. In addition to their regular equipment and special shoes for the animals, the members of the blacksmith section should each have a dressing pouch in order to render first aid to animals in the absence of the veterinary officer.

e. Commanders are responsible if the animals cannot travel, become tired prematurely, or stumble because of improper use of the calks, and must insure that men are well trained in their handling. (See TM 2-220.)

f. Animal vans are useful for transporting mules in rear areas. If these are not available, 2½-ton trucks with side extensions and sand footing may be substituted.

g. It is usually desirable that a mule replacement pool be maintained at the supply base and that all forage be left at the pool.

183. DOG TEAMS. In some regions dog team transportation may be used during the winter months. (See FM 25-6 and 70-15.)

Section III. SUPPLY

184. GENERAL. Units operating in remote mountain areas cannot depend upon local sources of supply since such sources usually provide only the bare necessities for

the inhabitants. This means that troops operating in this type of terrain must depend entirely on transported supplies. The amount of supplies that can be moved is usually very limited since hand-carry must be used to a large extent. Ordinarily, three stages or means of transportation are required: vehicles wherever roads permit, pack animals from truck (vehicle) heads as far as trails or terrain permit, and finally individual soldiers or porters.

185. SUPPLY BY AIR. When a unit becomes isolated from its lines of communications because of wide flanking movements, supply by air may be resorted to. (See FM 31-40 and 70-15.) Unpredictable weather and air currents, cloud-covered peaks, and lack of emergency landing places makes this method hazardous, especially in alpine terrain.

186. ROLLS. Except in a coordinated attack on a limited objective, rolls or packs should rarely be dropped. Difficulties of supply will congest the limited road net so that bedding will seldom reach the troops at night.

187. RATIONS. The use of the standard company kitchen is limited. C, K, or 10-in-1 rations will normally replace the B ration, but one hot meal per day should be served if possible. Hot meals may be prepared in the rear and moved forward on $\frac{1}{4}$ -ton trailers, pack animals, or porters using packboards. Extra heating units from field ranges, or small detachment stoves, should also be brought forward so that the food may be heated in the event that it cannot be consumed for some time. This is especially desirable when a unit is expected to be iso-

lated from its lines of communication for an extended period. More food is required for the strenuous work of mountain fighting and for maintaining body heat in cold weather than under ordinary conditions. For this reason, therefore, every effort should be made to serve hot prepared meals at every opportunity. Small gasoline stoves (1-burner cooking outfit) or individual fuel tablets and improvised heating methods are highly recommended for use by outposts, patrols, and other small groups which have no other means of heating their food.

188. AMMUNITION. Ammunition supply points must be moved forward frequently and kept relatively close to the front lines in order to reduce the difficulty and the delay in delivery that are usually imposed by precipitous terrain. The location of the ammunition supply point must be considered when emplacing weapons in order to reduce the ammunition haul to a minimum.

189. WATER. In many mountainous regions, water is abundant during all seasons. No matter how pure and clean mountain water may appear to be, purification is necessary and should be accomplished by approved methods. In some mountainous regions where there is little or no water, provisions must be made for carrying great quantities by the already overtaxed transportation system. Each company or battery will require two additional mules or a $\frac{1}{4}$ -ton truck with trailer for this purpose. The regulation 5-gallon water can has been found to be a very satisfactory container for mountain use. Whenever the use of any other type becomes necessary, the weight and bulk of the container should be seriously considered.

190. MOVEMENT IN ROCKY TERRAIN. In difficult rocky terrain, supplies will often have to be moved up vertical cliffs and across deep crevices. Such movement can best be accomplished by means of improvised cable-ways, block and tackle, hoists, and winches.

Section IV. EVACUATION

191. GENERAL CONSIDERATIONS. a. The evacuation of wounded in mountain warfare presents a difficult problem. In addition to the task of carrying a casualty to the nearest medical installation there is imposed the burden of traversing a rough terrain which in itself may offer obstacles to an individual free of any load.

b. The proportion of walking wounded to litter wounded cases is markedly decreased in mountains since even a slightly wounded individual may find difficulty and pain in struggling over the rugged terrain. As a result, the casualty, although initially classified as a walking wounded, may finally become a litter case.

c. In cold weather and in high mountains, speed of evacuation is vital. The incidence of shock following even a slight injury is very common in the cold and requires that a wounded man be treated very shortly after the occurrence of his injury and be removed from the field in as short a time as possible.

d. Special consideration must be given to the conservation of manpower. Litter hauls must be kept as short as the tactical situation will permit. A litter team is not capable of carrying a patient over mountainous terrain for the same distance as over flat territory. In

order to decrease the extent of the litter haul, all forward medical installations should be as close as possible to the front line troops.

e. It is important to be able to predict the number of casualties that can be evacuated with available personnel. It has been demonstrated that, when the average terrain grade exceeds 20° to 25° , the four-man litter team is no longer efficient and should be superseded by a six-man team. The average mountain litter team should be capable of climbing 400 to 500 vertical feet of average mountain terrain and return with a casualty in approximately 1 hour.

f. Another factor to be considered is night evacuation. Wounded should be located and evacuated during the day, as few would survive the vicissitudes of a night on a mountain during cold weather. Night evacuation over rough terrain is generally impracticable and the results are rarely commensurate with the effort. It should be attempted only when the route has been reconnoitered previously, has been marked with tracing tape, and has had a rope hand line installed. If routes are exposed to enemy observation and fire by day, night evacuation should be resorted to. When enemy activity makes it impossible to evacuate the wounded before dark, they should be brought to a sheltered place, treated, and prepared for the night. In the morning they may be removed with safety.

192. PLAN. The first and most important task before evacuation can be instituted is a thorough reconnaissance to arrive at a complete estimation of the terrain features and the road network. To this information is added a consideration of the prevailing climatic condition, the

facilities and personnel on hand, and the tactical mission to be accomplished. Only after all these factors are assembled can a true medical evacuation plan be formulated. To arrive at the final selection of routes, the following considerations must be kept in mind:

a. Snow and ice are firmest during the early morning hours.

b. Streams are shallowest during the early morning.

c. Mountain stream beds afford poor routes of evacuation because of rough slippery rocks and because the stream generally follows the steepest part of the slope.

d. Damp talus slopes provide poor routes of evacuation, since the moss covered rocks are slippery and afford poor footing. In general, all talus slopes should be avoided, since they result in accidental injuries to the litter bearers.

e. Routes should be chosen just below the crest of a ridge since there the trails are the easiest to follow and the areas the easiest to traverse.

f. When the prevailing slopes are steep, the most direct route down the slope should be chosen. In such cases, traversing the slope should be kept to a minimum.

193. PRINCIPLES OF EVACUATION. a. The methods of evacuation described in later paragraphs are not necessarily the only methods to be employed, although they have proven themselves satisfactory, and are to date the best known methods for handling casualties. However, medical personnel must at all times maintain an open mind towards new techniques and be ready to improvise and improve on the methods advocated. Maximum utility must be obtained from every item of medical equipment on hand.

b. In evacuating a casualty from mountainous areas—

(1) Select the smoothest route of evacuation to prevent the occurrence or increase of shock.

(2) Avoid unnecessary handling of the casualty.

(3) Place the legs of a casualty with a fractured leg on the elevated section of the litter.

(4) Cover the head of each casualty with his helmet to protect him against falling rock.

(5) If the route of evacuation is long and arduous and the casualty gives signs of shock which may become severe, leave him at a relay post or warming station under proper medical care until it is considered safe to continue his evacuation.

194. SPECIAL TRAINING. **a.** Prior to training the litter team in basic mountain evacuation, litter teams should receive instruction in assault climbing. (See ch. 5.)

b. Litter bearers and aid men must be thoroughly familiar with the use and care of rope as an item of equipment, and with the knots ordinarily used. (See par. 104 and figs. 16 and 17.)

c. Since litter teams will frequently find it necessary to evacuate casualties over extremely dangerous terrain, it is absolutely necessary that through constant practice they become proficient in the technique of belaying and the choice of belay points, to support adequately the litter and litter bearers, thus preventing serious falls. (See par. 106.)

195. PREPARATION FOR EVACUATION (fig. 48). **a.** To prepare a litter for the process of evacuation, pass one end of an 8 to 10 foot length of 1/2-inch

rope through one litter stirrup; pass the rope as a clove hitch around the litter brace joint; bring the end of the rope through the opposite stirrup of the litter; then tie the loose end to the belay rope with a bowline knot. This becomes the head of the litter. The rope acts as the belay rope for the litter and team. A stick, 12 inches long and 1 inch in diameter, placed inside the clove hitch along the hinge joint, will prevent the hinge joint from collapsing when obstacles are encountered.

b. (1) A casualty may be lashed to the litter in a variety of ways depending on the route of evacuation. If the route is short and relatively easy, no fixation will be necessary. On the other hand, if the evacuation must pass over a cliff or down a very steep slope, the casualty must be securely fixed to the litter. This is especially important if he is unconscious. In securing a casualty to a litter, the pelvic bones lend themselves most favorably to the tie, since injuries of the leg, abdomen, chest, or arms will not be involved in the procedure. A folded blanket is placed under the casualty's hips and folded like a diaper over his abdomen. This eases materially pressure caused by the sling at the points of contact. Using a 24-foot length of $\frac{1}{4}$ -inch rope, construct a pelvic sling of two clove hitches to fit the hips and upper thighs snugly. (See fig. 49(1).) From the sling, the rope is hitched around each of the upper stirrups of the litter, lashed across the chest of the casualty and tied to the opposite stirrup to prevent him from falling forward. (See fig. 49(2).) Another section of $\frac{1}{4}$ -inch rope 12 feet long is tied from the sling to each of the lower stirrups and then the ends are secured across the feet of the casualty. (See fig. 49(3).) In this manner he cannot slip from the litter either feet-first or head-first, since he

is suspended from his hips by the two guy ropes. When rope is not available, the casualty may be lashed to the litter with pistol belts or the litter securing straps.

(2) In the event that the patient is wrapped in blankets or a sleeping bag, the above method cannot be used. A clove hitch is made with one loop about the small of the patient's back and the other loop about his hips, just

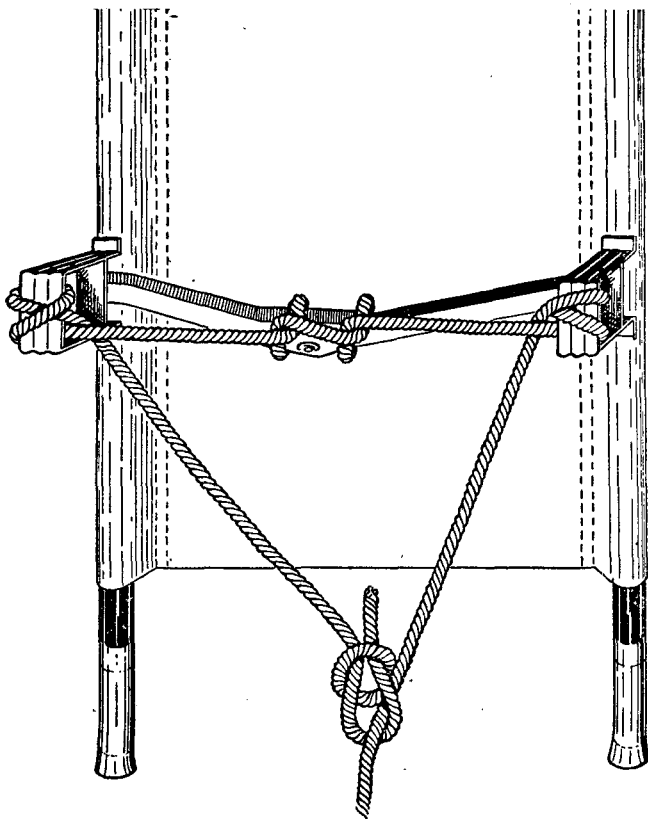

Figure 48. Method of fastening belay rope to litter.

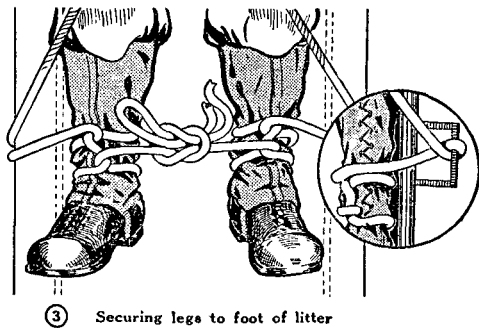
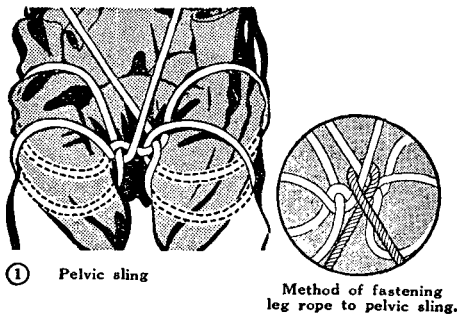
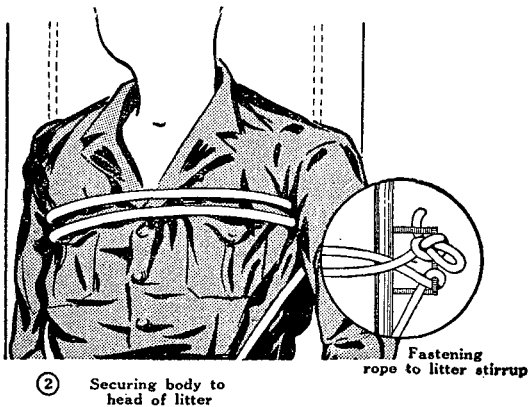

Figure 49. Securing casualty to litter.

below the buttocks. The running end from the upper loop is passed through the upper stirrup and across the patient's chest and secured. The running end from the lower loop is passed through the lower stirrups in a similar fashion.

196. ASCENDING AND DESCENDING SLOPES.

a. In ascending a steep slope, the litter is prepared and the casualty immobilized as described in paragraph 195b. (See fig. 50.) Two litter bearers take their places at the head of the litter, and a third, using the litter sling, takes his place at the foot. A thin sapling passed through the stirrups and extending 18 inches on either side of the lines affords a more secure grip for the two litter bearers at the head of the litter. The fourth and fifth men take their positions along the extended rope which is in the hands of the sixth, or belay, man. At the signal UP ROPE, the fourth, fifth, and sixth men pull while the first, second, and third men lift the litter and slowly climb. The men carrying the litter should not try to do all the work but should allow themselves to be pulled up the slope while they hold the litter off the ground. Men should exchange positions at each halt so that the work will be distributed equitably. When each belay point is reached, the litter is placed on the ground and a new belay position further up the slope is taken. Since this type of evacuation is very laborious, animals or vehicles for towing should be used when possible.

b. In making the descent, the litter is prepared as above and the casualty immobilized on the litter. (See fig. 51.) One man acts as belay man and another takes his position on the rope assisting him in lowering the

litter. The three litter bearers take their positions as for the ascent. The sixth man may assist with the litter or precede the team, picking a trail, making the passage more negotiable by clearing away shrubs and vines, and making a reconnaissance so that the team need not retrace its steps if a cliff should be encountered. In making the descent, the most direct practicable passage should be taken. All available trees and rocks should be used as belay positions.

c. If the slope is relatively free of underbrush or



Figure 50. Steep slope evacuation—ascending.

trees, a three-man team may be used. In this procedure skids are placed under the litter. Two saplings, each 15 to 20 feet long and about 3 inches in diameter at the heavy end, are cut. The small ends are placed between the canvas and the litter brace at the foot of the litter and secured; the butt ends are secured inside and to the stirrups at the head of the litter. In this manner, the butt ends of the saplings project about 9 to 14 feet beyond the head of the litter and act as a travois. One man, using an improvised rope sling, takes his position at the foot of the litter. (See fig. 52(1).) The second and third man are belay men, relieving each other as the rope is paid out by assuming successive belay positions. (See fig. 52(2).) In this way the descent need



Figure 51. Steep slope evacuation—descending.

not be interrupted while the belay position is being changed. Using this method of evacuation, it has been demonstrated that a casualty can be evacuated 200 to 250 vertical feet in about 10 minutes and that vertical faces of rocks 4 to 6 feet high can be descended without difficulty.

197. CLIFF EVACUATION. a. Evacuation via cliffs should be used only when absolutely necessary and only by experienced personnel. The cliff with the smoothest face is chosen for the route. In this method, at least four 120-foot ropes are necessary.

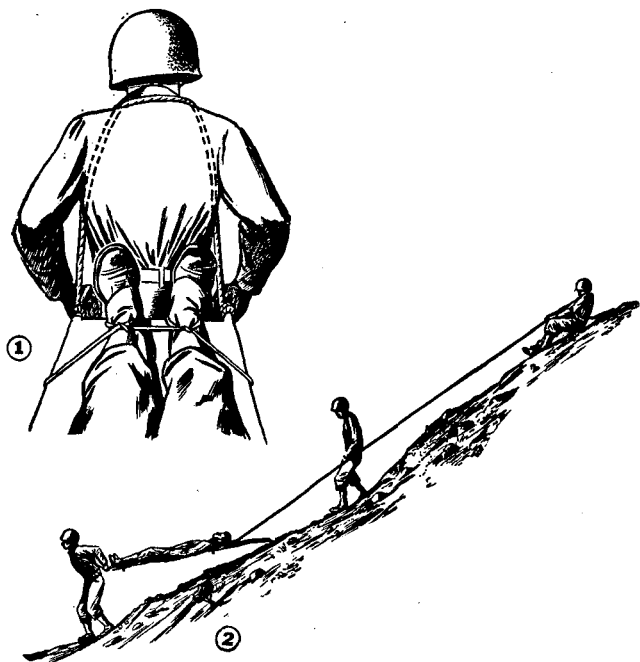

Figure 52. Litter travois.

b. The casualty is secured to the litter in the usual manner. Two poles, 8 feet long, are cut from trees with a diameter of 4 to 6 inches and used as runners. Both ends of the poles are beveled. The poles are attached to the stirrups by rope or wire; at the points of fixation, notches are made so that the rope will not be worn un-

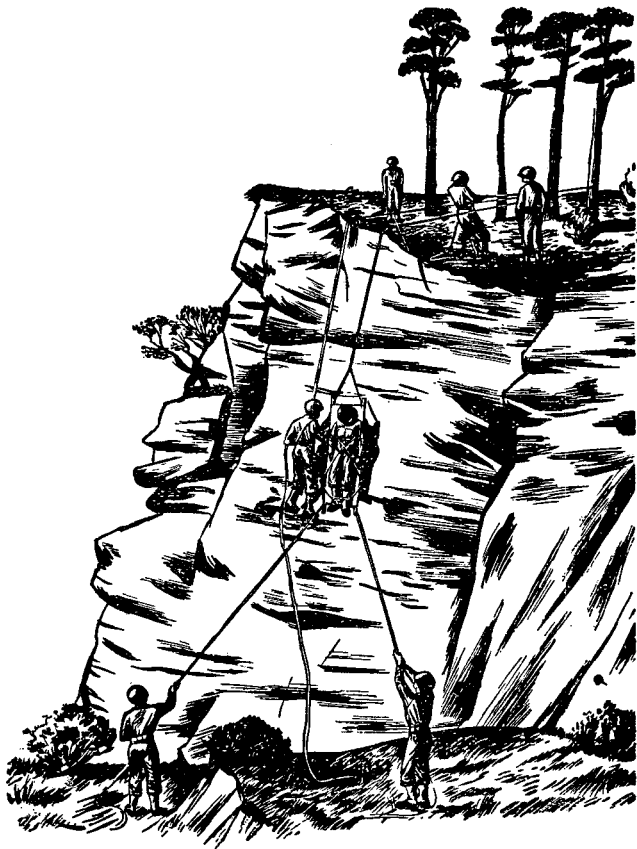

Figure 53. Cliff evacuation—descent.

necessarily by friction. A rope is attached to each stirrup at the foot of the litter for use as guy ropes in order to prevent the litter from spinning during the descent.

c. The litter is lowered over the cliff by two men while a third man belays it. (See fig. 53.) Meanwhile a fourth man escorts the litter on the descent by rappelling down a rope which parallels the route of evacuation, and assists the litter over projecting obstacles. The guy ropes are held taut by the fifth and sixth men who take widely separated positions at the bottom of the cliff. They can also help to ease the litter over protruding rocks by stepping away from the cliff and adding tension to the guy ropes. As the litter approaches the bottom of the cliff, the guy rope operators approach the litter, meanwhile maintaining tension on the ropes, and when close enough grasp the litter handles and lower it to the ground.

d. The same procedure can be used in evacuating a casualty up a cliff except for the following variations:

(1) An additional man will be needed at the top of the cliff to help raise the litter up and over the edge.

(2) The guy ropes must be attached to the stirrups at the head of the litter, instead of the foot.

(3) In the case of an overhanging cliff, a shears (A-frame) must be constructed at the top. (See FM 5-10 and TM 5-225.)

198. CARRIERS. a. Casualties who are not seriously injured but cannot negotiate a descent by themselves may be carried down by a carrier who is belayed from above. The carrier, in making his descent, leans away from the slope as much as possible and walks sidewise allowing the belay man to support him. Facing the

slope and descending backwards should be avoided since it leads to unnecessary falls. By keeping his lower leg well braced, keeping the weight of the casualty high on his back, and by grasping trees and rocks, he can descend very steep slopes with relative ease.

b. To secure the casualty to a carrier with a rope, the carrier rests on his hands and knees while the casualty straddles his back. (See fig. 54.) A 12-foot length of $\frac{1}{2}$ -inch rope is used. The center of the rope is placed under the casualty's buttocks. The right loose end is passed under the carrier's right armpit, across his chest, over his left shoulder, and under the casualty's left arm; the left loose end is passed under the carrier's left armpit, across his chest, and over his right shoulder, and under the casualty's arm, and the tie is made across the casualty's back. If the carrier suffers from the pressure of the rope against his chest, the rope may be crossed behind his neck instead of over the chest, before securing the ends around the casualty. The carrier's shoulders should be padded to prevent cutting by the rope.

c. An alternative method is to use two pistol belts hooked together, and draped over the carrier's shoulders. The casualty straddles the carrier and the belay man secures the loose ends of the pistol belts under the casualty's buttocks. Slackness in the pistol belt sling should be avoided, since the carrier is most comfortable when the casualty rests high on his back. (See FM 8-35.)

199. POLE CARRY (fig. 55). The pole-carry method should only be considered as a last resort, since it is very difficult for the litter bearers to handle. Its use is advisable only when narrow ledges must be traversed. The casualty is wrapped in two blankets and suspended

from a 14-foot pole by rope, pistol belts, or web belts. In suspending the casualty, all excess slack should be avoided, since it increases the side-sway during carry. A two-man team, one on each end of the pole, carries the casualty. If the pole is long enough, a four-man team may be used.

200. FIELD LITTER CARRIER. The collapsible field litter carrier may be used in the mountains provided the springs are removed and the brackets secured to the axle. The head of the litter is secured to the brackets of the litter carrier. By removing the springs, the center of gravity is lowered and the stability of the carrier is increased. Along level ground or in descend-



Figure 54. One-man carry using rope sling.

ing, two men can easily handle the vehicle. When ascending slopes, a six-man team is used. Two men take their places at the foot of the litter and escort it while the other four men pull the vehicle by means of a rope tied in the usual manner through the stirrups of the litter. This means of evacuation can be used on relatively smooth slopes only.

201. EVACUATION FROM TREES (fig. 56). It is best to use two men for the evacuation of wounded from trees, although one can accomplish the task by himself if necessary. Casualties in trees are usually either tied in place and cannot help themselves, or else have fallen and become wedged in such a way that they are helpless. One man climbs the tree, taking one end of the rope with him. He passes the rope over a branch in the tree above the position of the casualty and then ties a bowline on a bight. He slips one loop over each thigh of the casualty and then with the same rope ties a bowline around the casualty's chest. A man on the ground belays the casualty and lowers him from the

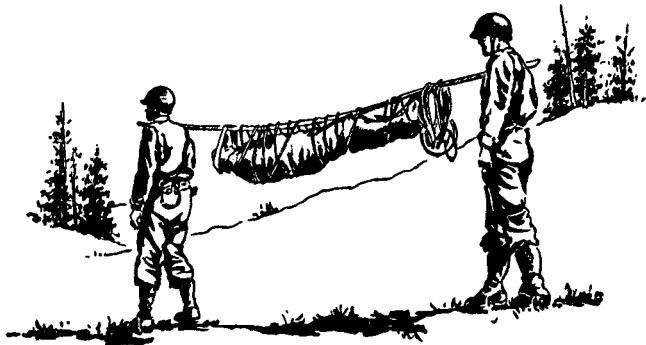

Figure 55. Pole carry.

tree. The first man escorts the casualty in his descent and prevents his movement from being impeded by intervening limbs or branches.

202. HORIZONTAL HAULING LINE (fig. 57). **a.**
The horizontal hauling line is one of the most complex

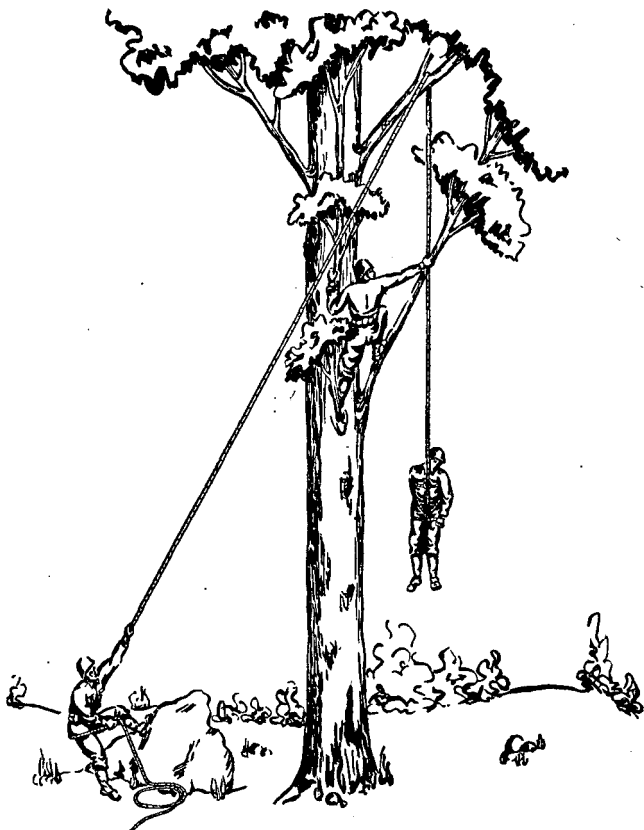

Figure 56. Tree evacuation—method of securing casualty with rope.

of the various methods of evacuation discussed so far. It is primarily used in those cases where a steep slope or cliff has to be passed and where, at the same time, there is an intervening obstacle such as a swiftly running mountain stream. It can also be used to span a chasm when bridges are demolished. This method should be instituted only where there will be a considerable number of casualties, such as at a warming station or collecting point, and should not be installed for the evacuation of only one or two. It can be used to lower or raise casualties over the obstacles. The hauling line is installed as follows:

(1) By means of a bowline, a $\frac{1}{2}$ -inch rope is secured to a tree far enough back from the edge of the cliff (6 to 10 feet) to permit freedom of movement by the medical personnel. On the opposite side, the other end of the rope is passed around another fixed point (tree, boulder, or possibly a vehicle) and, by means of a butterfly knot, is pulled as taut as is deemed necessary. All traverse rope should have a certain amount of slack.

(2) (a) To suspend the litter, two snaplinks are placed upon the traverse rope and one long litter carrying strap attached to each. A lower and upper retrieving rope is attached either to the litter stirrup or to the respective snaplinks. In the latter case the loose ends of each rope are tied together above the center of the litter so that when drawn up or down both snaplinks move simultaneously.

(b) If snaplinks are not available, two empty adhesive tape spools, 1 inch wide, may be utilized and the long litter carrying straps affixed to them. If these are used they should be placed on the traverse rope before the rope is fixed at both ends.

(3) After the casualty has been secured to the litter, the litter is raised and the litter carrying straps or suspension ropes are passed through the stirrups and fastened together or else secured to the opposite stirrup.

b. The operation of the hauling line is as follows:

(1) *Ascent.* Three men can easily raise the litter along the traverse by pulling on the upper retrieving rope. The pull should be steady and smooth in order to prevent jolting and sway.

(2) *Descent.* A gentle pull on the lower retrieving rope is enough to break the inertia and let gravity do the rest. During the descent, the men on the upper side should control the speed of the descent through their retrieving rope. It may be necessary to pull the casualty the last few feet when the litter nears the low point of the slack in the traverse rope.

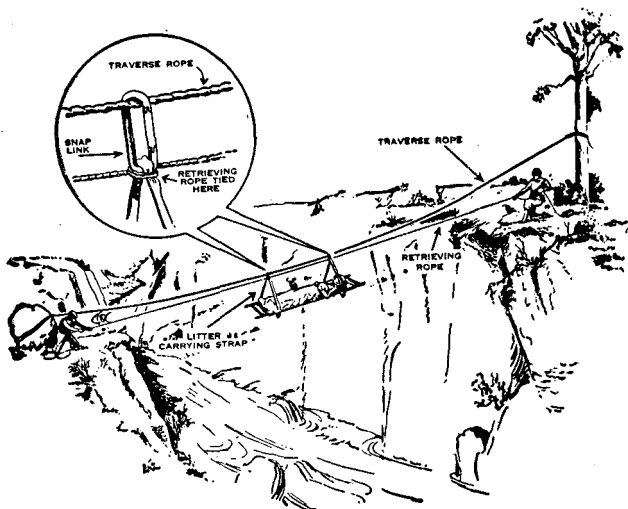

Figure 57. Evacuation by horizontal hauling line.

203. EVACUATION ACROSS STREAMS. Mountain streams or rivers are relatively shallow, but almost all possess strong rushing currents. In addition, the beds are often strewn with boulders covered by silt and mossy growths which afford very treacherous footing. To cross mountain streams safely, the element of support to the individual is of great importance. To attain this, two ropes are tied to trees on one bank and then pulled as taut as possible around trees on the opposite bank; the interval between ropes should be about $1\frac{1}{2}$ feet. The four litter bearers take their usual positions at each handle of the litter and then, by placing themselves between the ropes, place their free arms over their respective ropes and lean on them. These ropes will afford sufficient support for the team to cross the stream without mishap. In the case of a two-man team, the litter bearers take their positions between the ropes, place their arms over the ropes so that the support is the armpit of each man, and then raise the litter. A two-man team should use litter slings. When a very swift current is encountered, a rope may be attached to the litter and two additional men lend support by pulling the litter across while it is supported by the four litter bearers.

204. CACOLET LITTER (fig. 58). The cacolet litter may be used on a mule; however this arrangement is not considered very satisfactory for transporting seriously wounded since the motion of the litter is violent in rough terrain. A litter bearer must walk alongside the mule and steady the litter.

205. EVACUATION IN SNOW (fig. 59). Although litter bearers mounted on snowshoes will usually evacuate casualties on snow-covered mountains, downhill evac-

uation can be speeded up considerably when litter bearers are equipped with skis and toboggans. A trained skier can straddle the front end of a toboggan carrying a casualty, and guide it downhill. Speed and direction are controlled by stemming with the skis. For details of evacuation in snow, see FM 70-15.

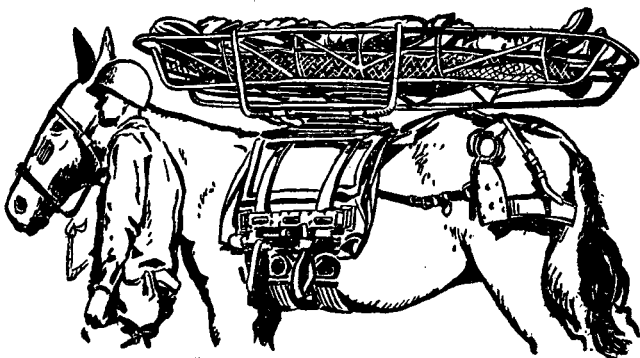

Figure 58. Cacolet litter mounted on pack saddle.

206. EXPEDIENTS. a. A serviceable emergency litter may be improvised in a few minutes when packboards are available. The litter is made by lashing two packboards to a pole frame. A casualty can be securely fastened to the litter by using the packboard straps.

b. The methods of evacuation described above present the fundamental means for overcoming natural obstacles. Knowing these various methods the medical soldier can, by using his own intelligence and ingenuity, amplify or curtail the procedures discussed. He should be observant, use every available item of equipment to the best advantage, improvise on every possible occasion, and utilize the available local means, whether animal or

mechanical, in order to conserve his own energy and manpower. Horses, mules, donkeys, cattle, wagons, carts, and sleds, if on hand, should be put into use whenever possible.

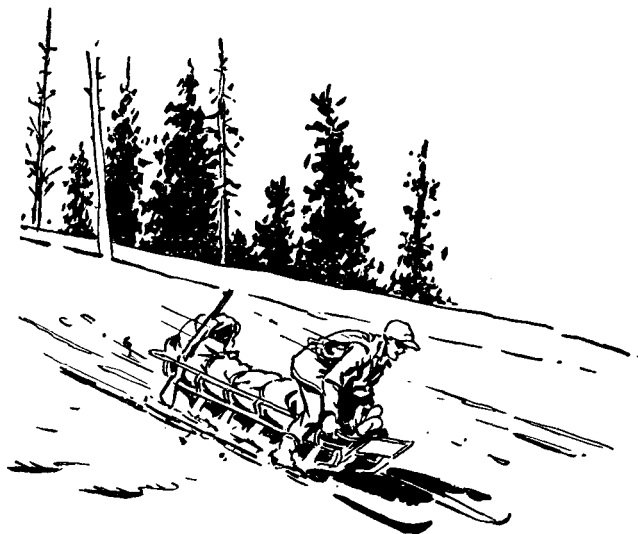

Figure 59. Evacuation by skier using toboggan.

CHAPTER 9

COMMUNICATIONS

207. GENERAL. In mountainous country a commander must give signal communication high priority in his planning and supervision. In most instances, communications can be maintained if regular equipment is supplemented by ropes, packboards and lamps and flags for visual signaling. Alternate parallel signal channels and combinations of wire and interconnecting radio channels are required to achieve maximum efficiency. For information on communications see FM 7-24 and 24-5.

208. WIRE. a. Wire is the most dependable means of maintaining contact. However, it must be laid with far more care and forethought than in ordinary terrain, in order to protect it from avalanches, rock falls, landslides, heavy storms, and deep snow.

b. The difficulties of laying and recovering wire are lightened by the use of $\frac{1}{4}$ -ton 4x4 trucks along side roads or trails not being used by more important motor transport. If trucks cannot be used, back-reels can be improvised by mounting hand reels on a wooden frame which can be lashed to a packboard. In laying wire across country, it is much easier to lay downhill than

uphill. In laying wire up to observation posts from battalions or batteries it is often easier and quicker to carry the wire forward on a reel, reconnoitering a route while doing so, and then to lay it back to the battalions or batteries.

c. All wire sections should avoid roads which are being used as main routes of advance. Due to the long distances and difficult routes involved, it is often advisable to simplify the wire net by having one wire serve several purposes. In the artillery fire distribution center, telephones can be T-spliced to battery trunk lines if the laying of a separate line is impracticable.

d. The truck reel is unsatisfactory for use in cross-country operation on foot, unless it is lashed to a pack-board along with the phone and other equipment which must be carried by the individual. This method is limited to the use of assault wire. Field wire can be efficiently laid from vehicles and should be used whenever the road net makes it possible.

e. In using assault wire great care must be taken in handling and laying since it is easily abraded or broken. Due to high winds and rough treatment, shorts will occur frequently, usually at tie-ins. A solution to this is to separate the conductors about 4 feet, then tie in each strand at 6-inch intervals on a tree or rock. No strength is lost by this method and, if the insulation is ruptured, no short across the line occurs.

f. Roads and trails should be used as guides only, the wire being laid at least 5 feet off the trail. Where no trails exist, wire should be laid over the less accessible routes. This is to prevent troops from using the wire as a guide and consequently breaking it. With

practice, wire teams can climb an easy route and swing the wire over an extremely difficult one. On steep slopes, wire should be tied in more frequently and tagged more often. This prevents interruption and simplifies maintenance.

g. Because of the uncertainty of radio communication, it is important that the wire system function continuously, during displacements as well as when command posts and observation posts are stationary.

h. In a battalion attack with two companies abreast, wire should be laid, when practicable, just behind the attacking echelon of each leading company. The company commander, following the wire crew, carries a field telephone or a sound-powered telephone and reports in to the battalion command post at prearranged intervals. When the units reach their objectives, lateral wire may be laid between the companies.

i. In the attack of a ridge, wire may be laid initially along a trail which may wind or zig-zag up the mountain. When the objective is gained, the wire crew should lay wire back to the command post on the azimuth, if at all possible. A relief wire crew can start picking up the wire along the trail, prepared to continue the advance when it reaches the top. This method shortens the length of wire to be policed, conserves wire, protects it from traffic, and removes it from the most obvious targets.

j. The use of telegraph is not limited by mountainous terrain, and should be resorted to as much as possible. The equipment is easily portable and will frequently function on lines unsuitable for telephone. Streams can be used for the grounding of telegraph circuits.

209. RADIO. a. Radio communication in mountainous terrain is frequently unreliable. This unreliability is due mainly to three factors: mountain and tree masks, rough handling (often unavoidable), and adverse weather. Low frequency amplitude modulated sets are best for mountain communication. The use of a relay set on the top of the mask will aid high frequency sets in crossing these masks. Artillery liaison and forward observer radios should be packed on packboards, so that when it is necessary to move across country, time will not be lost in packing them. The satisfactory operation of radios in this type of terrain will depend, to a great extent, on the resourcefulness and perseverance of the operators. The use of half-wave antennae oriented to utilize the directional characteristics will also be of value.

b. Radios have increased ranges on peaks or crests, but static interferences with reception. The position of the transmitter with respect to the mountains between it and the receiver affects the strength of the signal. If the angle from the transmitter to the highest point on the line between the transmitter and receiver is less than 45° , the loss of energy is of no practical significance. The greater the angle, the more energy is absorbed by the intervening terrain, and the range. Deep ravines and gullies and humid, leafy woods likewise reduce the strength of signals. Radios in rock caves and rock tunnels frequently can neither send nor receive. Shifting a set a few feet often improves short-wave transmission and reception.

c. The extreme and rapid changes in temperature encountered in mountains create a definite problem in keeping radio sets and batteries dry and at an even

temperature. Battery failure, moisture, and cold are the principal causes of reduced efficiency of the standard hand-carried radio. Radio operators should carry as many extra batteries as possible. In cold weather it may be necessary to wrap the set in a moisture-proof bag and keep it in a warm place. Extra batteries can be carried in the inside pockets. On warm days the batteries should be kept out of the sun. Radios should be moisture and fungus proofed.

d. Certain of the heavier radio sets are capable of being broken down and transported by packboards. Drill in packing, unpacking, and the setting into operation of such sets must be practiced until each member of the team is thoroughly familiar with the packing of each part, and the placing of each in the proper place. This will develop speed in handling and also insure against the loss of a vital part during a hurried move under difficult conditions.

e. For the operation and maintenance of radio equipment in extreme cold, see FM 70-15.

210. VISUAL SIGNALING. a. Visual signaling assumes increased importance in the mountains. Long lines of sight afford many excellent opportunities for its use. Visual equipment, being light in weight, is more easily carried than other communication equipment. It can also be easily improvised. Observation points are almost always available.

b. The semaphore method of visual signaling has proven very successful, being both easy to learn and usable at distances up to 4,000 yards. It is desirable for all officers, noncommissioned officers, reconnaissance and communication personnel, and messengers of units

operating in mountains to be able to read and send semaphore. It has been found that its use is not confined to communication personnel only, but that any soldier may have to send, however slowly, some important messages. A soldier may often be separated by only a short distance by impassable terrain from someone with whom it is necessary to communicate. The alphabet can be learned by the average soldier in 5 or 6 hours of proper instruction. Thereafter about 20 minutes of visual signaling drill daily will keep him in practice. Utmost precision in the execution of each move should be stressed from the beginning of the instruction. Care should be exercised in selecting the background for the flags, and in achieving all possible security from enemy interception. Wigwag is slow and clumsy, but can be read over somewhat longer distances and can be sent from less exposed positions.

c. The blinker light can be read at least 1 mile in clear daylight and several miles on clear nights. Radio operators should use the standard procedure in sending messages by blinker; prearranged message codes can be flashed by an operator who does not know the international code. Signal lamp equipment or, if this is not available, a flashlight, is also very useful.

d. Lamps and flags for visual signaling purposes will have to be improvised or procured as additional equipment.

e. Because observers must be well forward and because wire is limited, infantry heavy weapons personnel must often depend on visual signaling. In the commander's plans for coordinating supporting fires, he must provide for the use of visual signaling to complement other means.

211. MESSENGERS. a. Messengers are necessarily slow in the mountains and require intensive training to become dependable. In rough heavily wooded country, ½ mile per hour is considered fair speed. Even a trained messenger with a map can become lost in the daytime.

b. Messengers should be taught to depend on natural terrain features for orientation, rather than relying too much on roads and other man-made landmarks in finding their routes. It is seldom safe to send a single messenger because of the possibility of his being ambushed or lost. When in a new position, messengers should be sent to the command post prior to darkness to find the route. Since darkness will change the appearance of the trail, messengers should back-track after dark in order to familiarize themselves with landmarks in darkness. When operating in snow covered terrain, all messengers should be proficient skiers.

212. PIGEONS. Homing pigeons may be used successfully in the mountains. (See FM 24-5 and 11-80.) They are, however, subject to the following limitations:

a. The pigeon may have to be kept longer than the maximum prescribed time (2 days and 3 nights) because of the slowness and difficulty of interchange of birds that have not been released.

b. Rain may cause the pigeon serious difficulty in flying.

c. There are numerous birds of prey in the mountains which will kill pigeons.

213. MESSENGER DOGS. Well trained messenger dogs are dependable and may be useful in mountain operations.

APPENDIX

GLOSSARY OF MOUNTAIN CLIMBING TERMS

- Alpine terrain: High, barren mountains with little or no vegetation, most of which is above the tree line.
- Anchor rope: The part of a climbing rope tied from a belayer to a nearby anchor point to prevent the belayer from being pulled from his belay position in case of a fall by the climber.
- Assault rope: A rope secured to the face of a rock by pitons, trees, or other supporting objects to aid climbers in ascending and descending.
- Avalanche: The fall of a mass of snow or ice down the slope of a mountain. Does not apply to rock.
- Belaying: The paying out of a rope tied to a climber and running around the body of a belayer or around a tree, rock, or through a snap-link. This term also includes the application of braking action on a rope by the belayer in order to prevent a dangerous fall by the climber.

- Belay point: Point selected and used by the belayer from which he can best protect a climber and himself from a fall. Also a tree, rock, piton, or other object to which a rope may be tied for the purpose of belaying.
- Bergschrund: A large crevasse which separates the moving ice of a glacier from the anchored ice of the mountain mass.
- Calcareous rock: Shale rock; rock containing calcium.
- Chimney: A vertical fissure in a rock large enough to accommodate the body of a climber.
- Chockstone: A stone which has dropped into a chimney and become lodged there, or a piece of the original dyke.
- Chute: A chutelike fissure in the rock caused by erosion or glacial action. May be vertical or sloping. Generally wider than a chimney.
- Cliff: A high, steep rock face.
- Continuous climbing: When all members of a roped climbing party move simultaneously.
- Cornice: A mass of snow overhanging the leeward side of a ridge.
- Crack: A fissure in the rock only large enough to introduce fingers, feet, arms, legs, or pitons.

Crampons:	Hinged metal frames which may be attached to shoes or boots and from which spikes project downwards to facilitate walking on ice or hard snow.
Crevasse:	A fissure in the surface of a glacier caused by strains incident to the motion of the ice.
Dyke:	The intrusion in one type of rock of a different type.
Escarpment:	A long outcropping or cliff, extending for several miles.
Exposed climb:	A climb from which a fall would be dangerous or fatal.
Face of rock:	The sheer unbroken front of a cliff or a rock.
Fissure:	A crack in ice or rock.
Fixed rope:	A rope which is securely tied or belayed, usually at the top of a steep slope or cliff.
Free climbing:	Climbing without the aid of ropes.
Glaciers:	Large, slowly moving masses of ice and snow in the valleys of high mountains.
Glissading:	Descending a slope of hard packed snow by sliding in a sitting or standing position.
Gully:	A shallow ravine caused by erosion.
Hold:	A support of rock, snow or ice, used by the feet or hands in progressing from one position to another. Also the method of using such supports.

- Ice ax:** An instrument similar to a pick, consisting of wooden shaft, metal adze, pick and ferrule, intended primarily for cutting holds in snow and ice, as an aid to balance and in probing for concealed crevasses.
- Ice fall:** The portion of a glacier in which the surface ice is broken into a mass of blocks and crevasses due to an abrupt change in gradient of the bed of the glacier. Term does not apply to falling ice. (*See Avalanche.*)
- Igneous rock:** Rock formed through heat. Metal ore bearing rock.
- Moraine:** An accumulation of rock debris carried on or deposited by a glacier. Lateral moraines are found on either side of a glacier. Medial moraines are found in the center.
- New mountains:** High, rough, jagged peaks with little evidence of wind or water erosion.
- Old mountains:** Rounded, forested, rolling type of mountains with no precipitous peaks.
- Pitch:** A steep and difficult part of a mountain where it is impracticable or impossible to stop for a rest.

- Piton: A steel spike used as an aid in climbing. It is hammered into ice or cracks in the rock and serves as a belay point.
- Piton hammer: A short light hammer used for driving pitons. It has a wooden handle and the head comes to a sharp point which is used primarily for clearing debris from cracks and chopping ice off holds to be used.
- Rappel: The process whereby a climber lowers himself by means of a rope down steep rock, snow or ice.
- Rappelling: The act of executing a rappel.
- Rappel point: The rock, tree, or rope sling to which the rappel rope is secured.
- Rib: A small ridge on a rock face.
- Rock falls: The fall of any quantity of rock on a mountainside.
- Roping down: *See* Rappel.
- Scree: Steep slope composed of small unconsolidated rocks and gravel that will roll under foot.
- Snow cushion: An accumulation of wind-transported snow deposited in calm areas.
- Sound rock: Firm rock which holds together well. The opposite of rotten rock.

- Snaplink: An oval-shaped metal ring with a hinged gate to permit fastening it to a rope or piton.
- Talus slope: A slope composed of debris fallen from a dominating rock face. The steepness of talus slopes may vary from about 25° for fine debris to about 45° for coarse material.
- Tension climbing: Climbing in which the belayer holds the climber on the rock with tension on the rope.
- Timber line: The line at which trees cease to grow. The altitude depends on wind, moisture, soil conditions and geographical location.
- Trail markers: Wooden dowels, $3/16 \times 36$ inches, of which the upper 12 inches is painted orange or black. Placed in snow at intervals along route to identify it in fog, storm, or when trail has become obliterated.
- Traversing: Climbing across or zig-zagging, rather than climbing directly up or down.
- Travois: A primitive vehicle, frame, or net for hauling a load by dragging or by rope suspension.
- Tree line: See Timber line.
- Wall: A vertical or nearly vertical mountainside.
- Willow wands: See Trail markers.

INDEX

	<i>Paragraphs</i>	<i>Page</i>
Acclimatization	86-88	56
Aid stations	74-76	49
Aides for large unit movement	114	104
Air Forces	64, 65	36
Airplane, liaison	57	34
Altitude, effects on individual	86	56
Ammunition supply	31, 42, 49, 18, 26, 30, 54, 188	33, 201
Animal transport	180-183	196
Animal vans	182	198
Antiaircraft artillery	63	36
Antimechanized security	22	11
Antitank guns	43	26
Approach march	29	15
Armored units	60,62	35
Artillery:		
Communication	48, 55	30, 33
Coordination of fires	48	30
Fire control	56, 57	33, 34
In pursuit	49	30
Manner of employment	47	29
Observation	52	32
Positions	51	31
Tactical principles	46	29
Types used	46	29
Assault climbing	52, 98-142, 193	32 63 204
Attack:		
Ammunition	31	18
Approach march	29	15
Artillery emplacement	33	18
Cannon company	31	18
Command post location	30	16
Contact, maintenance of	29	15

	<i>Paragraphs</i>	<i>Page</i>
Detached missions	28	15
Fortified positions	34	19
Influence of terrain	36, 30	13, 16
Initiative of commanders	26	13
Maximum size of units	26	13
Night	30	16
Observation for supporting weapons	31	18
Orders	27, 31	14, 18
Pursuit	33	18
Routes of advance	26	13
Use of smokes	32	18
Avalanches:		
Classification	162	165
Dry snow	162	165
Formations	164	170
How caused	161	164
Safety rules	167	175
Slopes, ascending	167	175
Wet snow	162	165
Wind slab	162	165
Balanced climbing	103	65
Battalion aid station	75	49
Belaying	105-110, 132, 194	78 126, 195
Bivouacs	23-25	11
Blacksmith	182	198
Bridge construction	69	40
Cannon company	31	18
Cavalry	58, 59	34, 35
Chemical mortars	43	26
Clearing company	79	51
Cliff evacuation	197	212
Climate	96, 97	61
Climatic zones	144	142
Climbing aids	104, 105	72, 78
Climbing technique, basic	102-108	64

	<i>Paragraphs</i>	<i>Page</i>
Clothing	124,	120
	125, 173	120, 190
Clouds	154	149
Cold weather	143	141
Collecting company	78	50
Collecting point	78	50
Collecting posts, march	80	52
Collection station	78	50
Commander:		
Initiative	26	13
Qualification of	3	2
Responsibility for animal care	180	196
Responsibility for supply	5	3
Command post location	30	16
Communications:		
Artillery	55	33
Between security elements	21	10
Flags	210	228
Flares	210	228
Importance in mountains	207	224
Lights	210	228
Messenger dogs	213	230
Messengers	211	230
Pigeons	212	230
Radio	209	227
Semaphores	210	228
Smokes	210	228
Telegraph	208	224
Visual signals	210	228
Wire, hazards affecting	208	224
Wire, laying	208	224
Company aid men	77	50
Company aid station	76	49
Company assault climbers	121, 137	113, 134
Company medical section	76	49
Cornices	165	172
Counterattacks	38	23
Crevasse rescue	172	185
Crevassees	171	181

	<i>Paragraphs</i>	<i>Page</i>
Defense:		
Characteristics	35, 36	20
Counterattacks	38	23
Delaying action	35, 39	20, 23
Fortified areas in	40	24
Patrols, use of	37	21
Positions, selection of	37	21
Reverse slope	37	21
Withdrawals	39	23
Defensive tactics	4, 35-40	2, 20
Definitions	App.	231
Delaying action	39	23
Demolitions	71	47
Discipline, march	11	6
Discipline, water	90	58
Disposal, waste products	91	59
Dogs, messenger	213	230
Dog teams	183	199
Driving precautions	177-179	193
Engineers	82	53
Equipment, medical	66-72	37
Equipment, special	124-126,	120
	173	190
Evacuation:		
Across stream	203	221
By mule	174, 204	191, 221
By horizontal hauling line	202	213
Cliff	197	212
Difficulty of	191	192
From trees	201	218
Methods of	198-200,	214
	206	222
Preparation for	195	205
Reconnaissance	192	203
Steep slope	196	209
Training litter bearers	194	205
Use of rope	194	205

	<i>Paragraphs</i>	<i>Page</i>
Feeding troops	187	200
Field glasses	126	121
Footgear	125	120
Footholds	103	65
Forage, mule	182	198
Forecasting, weather	155	151
Formations for bivouacs	24	12
Fortified positions, attack on	34	19
Fortified positions, defense of	40	24
Free climbing	109, 113	97, 104
Glacial regions, dangers	168	177
Glacier lassitude	95	61
Glaciers, movement over	169-171	179
Glaze	151	147
Glissading	167	175
Grenades	45	28
Guides, mountain	99, 117	63, 111
Hand grenades	45	28
Handholds	103	65
Hauling lines	115	108
Horse cavalry	58	34
Hygiene, personal	89-92	58
Ice ax	126	121
Infantry (small units), importance of	41	25
Knots	104	72
Liaison, medical	81	52
Litter bearers, training	193, 194	204, 205
Litter bearer squads, special	76	49
Litter, cacolet	204	221
Litter carrier, collapsible field	200	216
Litter, emergency	199, 206	215, 222
Litter haul	78	50
Litter, preparation for evacuation	195	205

	<i>Paragraphs</i>	<i>Page</i>
Litter route	78	50
Logistics	5	3
Log ramp	133	129
Machine guns, employment	43	26
Maladies	93-95	60
Marches:		
Collecting posts	80	52
Column length	13	7
Discipline	11	6
Effect of ascents and descents	9	5
Halts	12	6
In cloud or fog	18	9
Mountain	112	103
Night	17	8
Objectives	15	8
Pace maker	12	6
Rate	10	6
Route selection	14	7
Technique	8	5
March rate, mule	181	197
Medical Corps	73-83	48
Medical decentralization	73	48
Medical equipment	82	53
Messenger dogs	213	230
Messengers	211	230
Mines	72	48
Mortars, employment	43	26
Mortar maintenance	178	194
Motor transportation	174-179	191
Mountainous terrain, characteristics	1	1
Mountain sickness	93	60
Mountain stream crossing	123	116
Mountains, high; influence on tactics	4	2
Mountain weather	1,143-155	1,141
Movement over snow and ice	166, 167	174, 175
Mules:		
Care by veterinary	182	198
Commander's responsibility	182	193

	<i>Paragraphs</i>	<i>Page</i>
Forage	182	198
Girths	182	198
Handling on trail	181	197
Pack train	180	196
Pack train, security for	181	197
Pay load	180	196
Rate of march	181	197
Replacement pool	182	198
Shoeing	182	198
Training	180	196
Use in evacuation	180, 204	196, 221
Night attack	30	16
Night marches	17	8
Observation for supporting weapons	31, 52	18, 32
Observers	118, 139	112, 136
Offensive combat. (See Attack.)		
Operations:		
Bivouacs	23-25	11
Command decentralization	6	4
Defensive	35-40	20
In winter	158	157
Marches	8-18	5
Offensive	26-34	13
Security	19-22	9
Standing operating procedure	7	4
Orders	27-31	14
Organization	2	1
Organization, special medical	73	48
Packboards	126	121
Pack train companies	180	196
Pack train, security for	181	197
Patrols, flank	120	113
Patrols in defense	37	57
Patrols, reconnaissance	119	112
Physical conditioning	88	58

	<i>Paragraphs</i>	<i>Page</i>
Pigeons	212	230
Piton hammer	105	78
Pitons	105	78
Pole litter	199	215
Positions, artillery	51	31
Positions in defense	37	21
Principles of tactics	4	2
Procedures, climbing	102-111	64
Pursuit	33, 49	18, 30
Qualifications of commanders	3	2
Quartermaster Corps	84, 85	54
Quartermaster, pack train companies	180	196
Radios	21	10
Rainfall	147	144
Rappel	107	88
Rappel tower	133	129
Rations, preparations of	187	200
Reconnaissance, aerial	65	36
Reconnaissance for truck use	174	191
Reconnaissance, motorized	174	191
Regimental aid station	74	49
Reverse slope defense	37	21
Rifle grenades	45	28
Rifle, sniper's	126	121
Road blocks from trucks	174	191
Road construction	68	38
Rock climbing, military	98-142	63
Basic technique	102-108	64
Climbing school	128-132	123
Exercises in climbing	135-142	131
Mass troop movement	112-114	103
Movement of equipment	115	108
Movement of trained personnel	109-111	97
Supplementary training	133, 134	129
Tactical employment of climbers	116-122	111

	<i>Paragraphs</i>	<i>Page</i>
Rock engineers	138	135
Rockets	45	28
Rock falls	108	94
Rolls, individual	186	200
Roped climbing	110	97
Ropes	104, 106, 107	72, 81 88
Routes affecting tactics	4	2
Routes of advance	26	13
Routes, selection of	108	94
Sanitation	89, 90	58
Security:		
Antimechanized	22	11
Approach march	29	15
Communication between elements	21	10
Flank	21	10
Listening posts	20	10
Night	19	9
Outposts	19	9
Pack trains	181	197
Use of commanding ground	19	9
Shelters, improvised	83	53
Signal communication. (See Communications.)		
Smoke in attack	32	18
Snipers	44, 139	28, 136
Snaplinks	105	78
Snow blindness	168	177
Snow, classification of	159, 160	158, 163
Solar heating	148	144
Storms	149-151, 153, 154	146 149
Stream crossing	123	116
Streams, evacuation across	203	221
Supply:		
Air	185	200
Ammunition	11, 42, 182	18, 26, 198
Decentralization of	85	54

	<i>Paragraphs</i>	<i>Page</i>
Factors affecting	85	54
Methods of	184	199
Movement	190	202
Plans for	85	200
Water	90, 189	58, 201
Tactical use of assault climbers	116-122	111
Tactics	4, 41	2, 25
Tank destroyer units	61, 62	35
Terrain, dominant	26	13
Terrain, mountainous, characteristics	1	1
Thunderstorms	149	146
Toboggan, evacuation by	205	221
Traffic control	53, 176	32, 192
Training, care exercised in	86-88	56
Transport, animal	180-183	196
Transportation, motor	174-179	191
Troops, feeding	187	200
Truck driving	177-179	193
Trucks:		
As road blocks	174	191
Limitations on use	174	191
Maintenance of	176	192
Reconnaissance for use	174	191
Use in mountains	174	191
Valley disease	94	60
Veterinary	182	198
Visual signals	210	228
Walking, mountain	102, 136	64, 132
Waste products, disposal	91	59
Water discipline	90	58
Water requirements	90	58
Water supply	90	58
Weapons, factors governing use	42	26
Weather determinants	146-148	143
Weather, mountain, characteristics	1, 143-155	1, 141
Weather predicting methods	152-155	148

	<i>Paragraphs</i>	<i>Page</i>
Winds	148	144
Wind velocity	148	144
Winter characteristics	156-173	156
Wire communication	208	224
Withdrawals	39	23