

MHI
Copy 3

THIS
IS AN INTERMEDIATE
TECHNICAL LIBRARY

FM 44-4

WAR DEPARTMENT FIELD MANUAL

DECLASSIFIED UNCLASSIFIED BY

AUTHORITY OF DOD DIR. 5200.1 R
BY *RAK 259* ON *101253*

EMPLOYMENT OF

ANTIAIRCRAFT

ARTILLERY GUNS

RESTRICTED. DISSEMINATION OF RESTRICTED MATTER.
No person is entitled solely by virtue of his grade or position to knowledge or possession of classified matter. Such matter is entrusted only to those individuals whose official duties require such knowledge or possession. (See also paragraph 23b, AR 380-5, 15 March 1944.)

WAR DEPARTMENT - JUNE 1945

WAR DEPARTMENT FIELD MANUAL
FM 44-4

This manual supersedes FM 4-104, 30 June 1943

EMPLOYMENT OF
ANTIAIRCRAFT
ARTILLERY GUNS



WAR DEPARTMENT

JUNE 1945

RESTRICTED. DISSEMINATION OF RESTRICTED MATTER.

No person is entitled solely by virtue of his grade or position to knowledge or possession of classified matter. Such matter is entrusted only to those individuals whose official duties require such knowledge or possession.

(See also paragraph 23b, AR 380-5, 15 March 1944.)

*United States Government Printing Office
Washington, 1945*

WAR DEPARTMENT
Washington 25, D. C., 5 June 1945

FM 44-4, Employment of Antiaircraft Artillery Guns, is published for the information and guidance of all concerned.

[AG 300.7 (18 May 45)]

BY ORDER OF THE SECRETARY OF WAR:

OFFICIAL:

J. A. ULIO

Major General

The Adjutant General

G. C. MARSHALL

Chief of Staff

DISTRIBUTION:

AAF(20); AGF(40); ASF(2); T of Opns(5);
Arm & Sv Bd (1) except 44(2); Def Comd (5);
HD(2); Gen & Sp Sv Sch(10) except 44(250);
USMA(20); ROTC(1); Tng C 44(50); A(5);
CHQ(5); D(2); B 4, 44(5); R 4, 44(5); Bn
44(5); AF(5). T/O & E: 44-7(2); 44-15(25);
44-115(25); 44-200-1(5).

Refer to FM 21-6 for explanation of distribution formula.

CONTENTS

	<u>Paragraphs</u>	<u>Page</u>
CHAPTER 1. ORGANIZATION AND STAFF OFFICERS.		
<i>Section I.</i> Battery.....	1-2	1
<i>II.</i> Battalion.....	3-4	1
<i>III.</i> Group.....	5	2
<i>IV.</i> Staff Officers.....	6-7	2
CHAPTER 2. CHARACTERISTICS OF GUNS AND ACCESSORIES.....	8-16	4
CHAPTER 3. MISSIONS.....	17-21	14
CHAPTER 4. CONTROL OF FIRE.		
<i>Section I.</i> General.....	22-23	16
<i>II.</i> Guns.....	24-28	18
CHAPTER 5. COMMUNICATIONS.		
<i>Section I.</i> General.....	29-30	21
<i>II.</i> Radio communication.....	31-32	21
<i>III.</i> Wire communication.....	33-34	23

	<u>Paragraphs</u>	<u>Page</u>
CHAPTER 6. EMPLOYMENT OF AAA GUNS.		
<i>Section I.</i> General.....	35-51	27
<i>II.</i> Static employment.....	52-62	55
<i>III.</i> Mobile employment.....	63-72	62
 CHAPTER 7. EMPLOYMENT AGAINST GROUND AND NAVAL TARGETS.		
<i>Section I.</i> General.....	73-75	72
<i>II.</i> Engagement of mechanized targets.....	76-77	73
<i>III.</i> Employment as antitank artillery.....	78-82	76
<i>IV.</i> Assault of fortifications.....	83-85	80
<i>V.</i> Employment as field artillery..	86-89	82
<i>VI.</i> Employment as seacoast artillery	90-94	84
 CHAPTER 8. RECONNAISSANCE, SELECTION, AND OCCUPATION OF AA POSITIONS.		
<i>Section I.</i> General.....	95-100	86
<i>II.</i> Reconnaissance by higher echelons.....	101	87
<i>III.</i> Battalion reconnaissance.....	102-109	88
<i>IV.</i> Gun battery reconnaissance and occupation of positions.....	110-104	90
 CHAPTER 9. SECURITY AND PROTECTION.		
<i>Section I.</i> Concealment.....	115-120	96
<i>II.</i> Cover.....	121-125	97
<i>III.</i> Local security.....	126-131	98

	<u>Paragraphs</u>	<u>Page</u>
CHAPTER 10. SUPPLY AND EVACUA- TION.		
<i>Section I.</i> Supply.....	132-139	101
II. Evacuation.....	140-142	103
APPENDIX I. TABULAR DATA ON BRL'S AND CRITICAL ZONES.		105
II. ESTIMATES, PLANS, AND ORDERS.....		106
INDEX.....		110

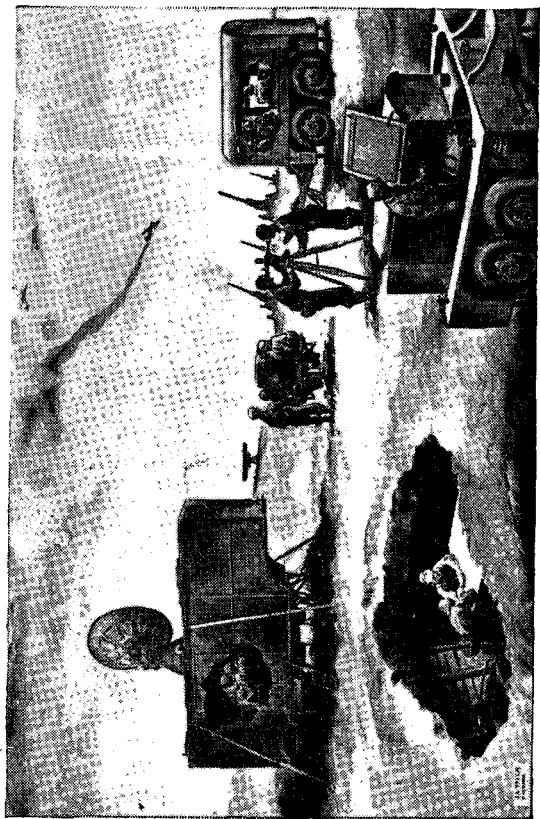

Figure 1. Gun battery fire unit.

(This figure shows, for purposes of illustration, fire control instruments and guns which make up the fire unit, but does not show an actual combat position.)

RESTRICTED

This manual supersedes FM 4-104. 30 June 1943

CHAPTER 1

ORGANIZATION AND STAFF OFFICERS

Section I. Battery

1. **FIRE UNIT.** The fire unit of the gun battery consists of four AAA guns (90-mm or 120-mm), four caliber .50 machine guns, the radar and fire control equipment, and the necessary personnel. This fire unit must be relieved from all details except firing. Additional elements are included in the battery organization to enable the battery to function as a unit.

2. **BATTERY.** a. The gun battery consists of a battery headquarters and a firing unit. Within the battery headquarters are the headquarters section, the maintenance section, and the communication section. The firing unit consists of a range-detector section, four gun sections, and a machine-gun and executive officer's section.

b. The battery commander is responsible for the administration, training, and tactical employment of the battery. He is assisted by a battery executive, a range officer, and an assistant executive.

c. The detailed organization for the mobile AAA gun battery is contained in T/O & E 44-17 and that for the semimobile battery in T/O & E 44-117.

Section II. Battalion

3. **ORGANIZATION.** a. The gun battalion consists of a headquarters and headquarters battery, medical detachment, and four gun batteries.

Note. For definition of military terms not contained in this manual, see TM20-205; for list of training publications, see FM21-6.

b. The headquarters battery consists of a battery headquarters section, an administration and personnel section, an operations and intelligence section, a communication section, a supply section, a transportation section, and an ammunition section.

c. The organization of the mobile AAA gun battalion is contained in T/O & E 44-15, and that of the semimobile battalion in T/O & E 44-115.

d. The essential difference between mobile and semimobile organizations is the lesser number of motor vehicles in the semimobile organizations, and the consequent fewer personnel. Mobile organizations may be used in mobile or static situations; semimobile only in static situations, unless additional transportation is provided.

4. BATTALION COMMANDER. The duties and responsibilities of the battalion commander are contained in FM 44-1 (when published).

Section III. Group

5. GROUP. a. **General.** The AAA group is a tactical and administrative unit, flexible in its composition. It normally consists of two or more battalions and a group headquarters and headquarters battery. Any combination of the various type AAA battalions may be organized as a group. For detailed organization of the group headquarters and headquarters battery, see T/O & E 44-12.

b. **Group commander.** The duties and responsibilities of the group commander are contained in FM 44-1.

Section IV. Staff Officers

6. GENERAL. a. The functions, duties, and responsibilities of a commander are not only commanding, leading, and directing, but also planning, controlling, and coordinating all agencies to carry out his will. Since in the larger units it is physically impossible for one man to carry out all of these functions, some of them must be delegated to assistants (staff officers). The responsibilities of command and leadership cannot be delegated.

b. The staff assists the commander by providing basic information and technical advice by which he arrives at his decisions, by developing details of the commander's plan, translating the plan into orders, and transmitting the orders to subordinate agencies, and by insuring the execution of the orders by constructive inspection and observation for the commander. Staff action must frequently be rapid, and some of the steps may not be reduced to writing. Members of a staff keep the commander informed on important matters pertaining to their functions. The staff anticipates future needs and drafts tentative plans to meet them. It supplements the commander's efforts to secure unity of action throughout the command.

c. AAA battalion and higher commanders are provided with unit staffs. Certain duties growing from their functions are assigned to staff assistants.

7. DUTIES OF STAFF OFFICERS. a. **General.** See the appropriate T/O for designation of staff officers for AAA units.

b. The duties of staff officers are contained in FM 44-1 and FM 101-5.

CHAPTER 2

CHARACTERISTICS OF GUNS AND ACCESSORIES

8. **GENERAL.** The disposition of AAA guns is influenced by the characteristics of the weapons and accessories.

9. **RANGES.** a. The limit of possible fire at air targets is not the maximum range of the guns but is fixed by the time element of the fuze. The maximum horizontal range at which a target can be engaged decreases with an increase in the altitude of the target. The average maximum effective slant range of antiaircraft artillery guns for AA fire is generally considered to be as follows: for the 90-mm gun, 12,500 yards; and for the 120-mm gun, 16,000 yards.

b. However, for the 90-mm gun, the maximum horizontal range is 19,560 yards and the maximum vertical range is 13,426 yards. For the 120-mm gun, the maximum horizontal range is 27,162 yards, the maximum vertical range, 19,151 yards. Theoretically it would be possible, by using fuzes and fire control equipment designed for the purpose, to fire AA fire out to these maximum ranges, although, dispersion would be great at extreme ranges.

c. Time fire at terrestrial targets, with mechanical time-fuzed shell, is limited to the ranges indicated in a above. Percussion fire at terrestrial targets is limited only by the maximum horizontal range of the guns (b above), but the dispersion is great at extreme ranges.

10. **MOBILITY.** Tactical mobility necessarily must consist of many factors in addition to the physical movement of the equipment from one site to another. AAA gun equipment is heavy (10 tons, 90-mm M1A1 guns; 16 tons, 90-mm M2; 31 tons, 120-mm M1; 10 tons, SCR-584; 16 tons, M4 tractor; 7 tons, M9 director and trailer). Therefore, it is limited to movement over fairly good roads and bridges, and solid terrain. While 90-mm AAA guns may be positioned to fire with on-carriage sights in a few minutes, a much greater period of time will be necessary to

install, orient and synchronize the complete fire control system for the unit concerned. The time elements shown in figures 2 and 3 are based on clear weather and favorable conditions. Detailed adjustments on fire control equipment were not considered in the estimates. These figures may be increased for unfavorable weather conditions, also for annoyance by enemy fire. Night work is approximately two-thirds as effective as day work and such work should be planned to take full advantage of moonlight hours.

11. LIMITING RANGES. a. (1) Figure 4 shows the limiting ranges of a 90-mm gun using a 30 fuze number mechanical time fuze. This figure is constructed by plotting on the 90-mm trajectory chart the cam limits of the M7 director. Figure 5 shows the limits of the M9 director using the 30 fuze number mechanical time fuze, and its capabilities without regard to fuze or gun limitation. Whereas individual directors function within varying limitations, the limits graphically indicated show a composite of the performance of many directors. These representations are merely vertical projections and show the limiting ranges with the gun fired at any single azimuth. The line labeled "Trajectory of 80° quadrant elevation" is the trajectory produced by the gun when it is fired at its maximum practical elevation.

	O P E R A T I O N	Time—Day Weather— Clear		Time—Night Weather— Clear		Time—Day Weather— Snow	
		Clear Level Ter- rain	Brush- Covered Level Terrain	Clear Level Ter- rain	Brush- Covered Level Terrain	Clear Level Ter- rain	Brush- Covered Level Terrain
Note 1. E— From order "Prepare for Action" with equipment is emplaced and crew is at attention 5 paces behind equipment.							
Note 2. M— From order "March Order" until equipment is in traveling order and crew in trucks.							
Note 3. Time given is in minutes.							
TYPE OF EQUIPMENT							
90-mm gun, M7 director, M1 height finder, M18 generating unit and M1 cable system.	E M	9' 10'	11' 12'	25' 25'	30' 30'	35' 35'	40' 40'
120-mm (4.7 inch) gun, M10 director, SCR-545, M18 generating unit, and M3 and M7 cable systems.	E M	25' 30'	30' 35'	38' 45'	45' 53'	50' 60'	60' 70'
120-mm (4.7 inch) gun, M7 director, SCR-584, M18 generating unit, and M3 and M7 cable systems.	E M	25' 30'	30' 35'	38' 45'	45' 53'	50' 60'	60' 70'
120-mm (4.7 inch) gun, M10 director, SCR-584, M18 generating unit, and M3 and M7 cable systems.	E M	25' 30'	30' 35'	38' 45'	45' 53'	50' 60'	60' 70'
90-mm gun, M1, on M1A1 mount.	E M	7' 8'	9' 10'	22' 22'	27' 27'	32' 32'	37' 37'
90-mm gun, M2 mount.	E M	6' 7'	8' 9'	22' 22'	27' 27'	32' 32'	37' 37'
120-mm (4.7 inch) gun.	E M	25' 30'	30' 35'	38' 45'	45' 53'	50' 60'	60' 70'
.50 caliber machine gun, M2.	E M	2' 2'	2' 3'	3' 3'	4' 4'	3' 4'	4' 4'
M9 or M10 director.	E M	13' 19'	15' 22'	25' 25'	30' 30'	35' 35'	40' 40'
M7 director.	E M	3' 2'	4' 3'	5' 4'	7' 4'	10' 9'	12' 9'
Height finder.	E M	4' 4'	5' 5'	10' 10'	12' 12'	18' 18'	20' 20'
M18 generator.	E M	3' 4'	4' 5'	10' 10'	13' 13'	15' 15'	18' 18'
SCR-545.	E M	11' 12'	13' 14'	30' 30'	35' 35'	40' 40'	45' 45'
SCR-584.	E M	14' 11'	16' 13'	40' 40'	45' 45'	50' 50'	55' 55'

Figure 2. Time required to emplace matériel.

ORIENTATION AND SYNCHRONIZATION

<i>Type of Equipment</i>	<i>Time</i>
<i>a.</i> 90-mm gun, M7 director, M1 height finder, M18 generating unit, M1 cable system.	10 minutes
<i>b.</i> 120-mm (4.7 inch) gun, M10 director, SCR-545.	15 minutes
<i>c.</i> 120-mm (4.7 inch) gun, M7 director, SCR-584.	15 minutes
<i>d.</i> 120-mm (4.7 inch) gun, M10 director, SCR-584.	15 minutes
<i>e.</i> M7 director and SCR-584	8 minutes
<i>f.</i> M9 director and SCR-584.	10 minutes
<i>g.</i> 90-mm gun, M9 director and SCR-584.	15 minutes
<i>h.</i> 90-mm gun, M9 director and SCR-545.	15 minutes
<i>i.</i> M10 director and SCR-584.	10 minutes

In orientation and synchronization, accuracy is of paramount importance and while the above times are fair for ideal conditions, consideration must be given to any conditions which are unfavorable and the time estimates must necessarily be increased.

Figure 3. Time required for orientation and synchronization.

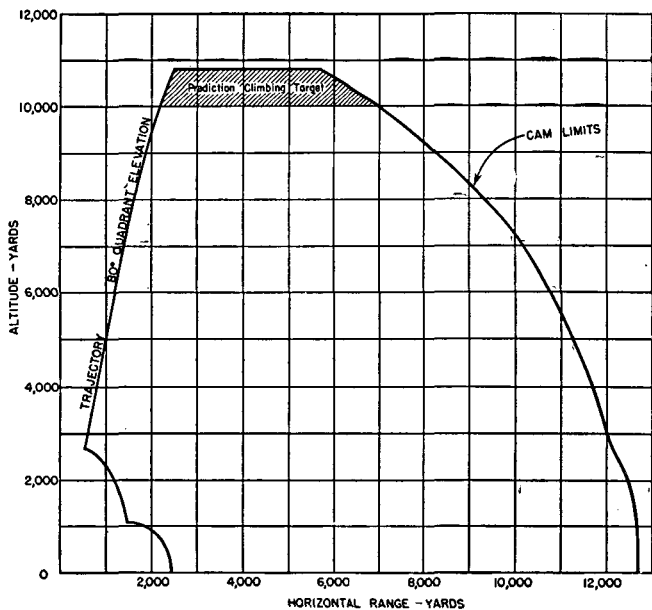

Figure 4. Limiting ranges for 90-mm gun (using the M7 director).

(2) A better conception of the entire field of fire of a single 90-mm gun, using the M9 director, can be obtained from a study of figure 6. This figure was obtained by rotating that portion of figure 5 showing the fuze limitation 360° about the gun as a center.

(3) The outer limits of fire are clearly shown in figure 6. If a segment is removed from this figure by making vertical cuts through the center of the model, it results in figure 7. This figure shows the exact shape of figure 6 and gives both the inner and outer limits of fire. This figure is put to further use in developing a defense in chapter 6.

b. In addition to the limitations imposed by matériel and ammunition, weather conditions, time of day, and degree of visibility will limit effective fire when visual tracking of fire control instruments is employed instead of radar data. Under certain conditions, due to equipment failure, jamming, ground clutter, or storm cloud formations, the operational efficiency of the gun laying radar may be reduced to such a degree as to require visual tracking. In this event, ground observation would be hampered by cloud banks, fog, rain, or heavy mists in or above which enemy aircraft may be flying.

c. The ceiling of some bombers carrying a full military load may be as high as 40,000 feet. However, the majority of aircraft in service today do not attain such altitudes. In addition, bombing accuracy diminishes as the altitude of attack increases, and atmospheric conditions will often limit the altitude at which a successful attack can be made. The use of radar bomb sighting largely offsets the limitations of atmospheric conditions. An appreciable percentage of bombing attacks can be expected to be made within range of AAA guns, particularly 120-mm guns.

12. RADARS. The radar authorized for issue to each gun battalion headquarters battery and to each gun battery is either the SCR-584, SCR-784, or the SCR-545. They are mobile, short and medium range radar units, designed primarily for use with an antiaircraft artillery battery to supply present position data to the M7, M9, or M10 directors, and for medium range searching to provide advance

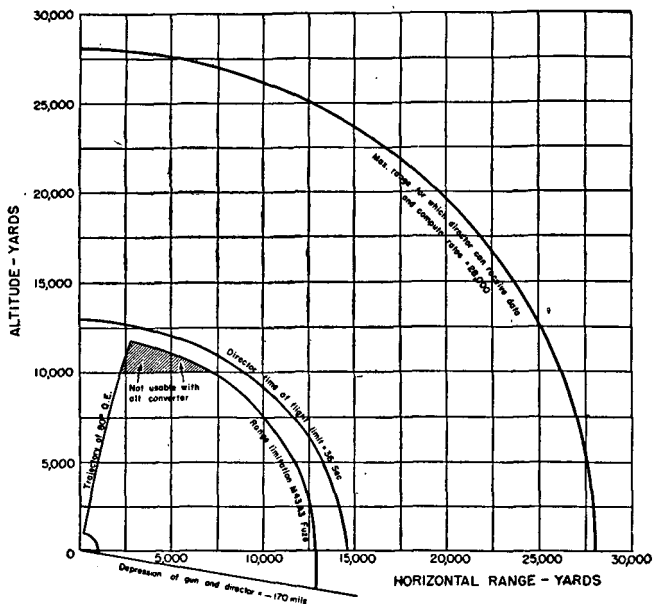

Figure 5. Limiting ranges for the 90-mm gun. The capabilities of the M9 director are indicated. The depression below horizontal is the depression stop limit of the director.

warning of the approach of enemy aircraft. For surveillance purposes, the SCR-584 and SCR-784 have a slant range of approximately 70,000 yards, and the SCR-545 a slant range of approximately 100,000 yards. These sets are designed to automatically follow moving targets within range and to simultaneously supply present position data to the gun director. *A good operating position for the radar is the primary consideration in the choice of the gun battery position since the accuracy of the data produced is dependent upon good siting.*

13. FIRE-CONTROL SYSTEM. a. **General.** All AAA gun batteries are provided with equipment for predicting a future position of the target on a basis of its present performance and determining firing data for the guns. This fire-control system is the normal source of firing data for the battery.

b. **Types.** There are various types of directors, radars, and other fire-control equipment. The fire-control equipment available to a fire unit may be combined in various ways and employed for either seen or unseen fire. The radar is the primary source of present position data and is used to supply all elements of data to the director. If conditions of visibility are good and visual tracking is employed at the director or tracking head, the radar is used to furnish range or altitude data only. The height finder may also be used to obtain ranges or altitudes, if radar data cannot be obtained for any reason.

c. **Direct-fire sights.** AAA guns, except 120-mm, are provided with direct-fire sighting equipment for the close-in engagement of mechanized and other ground or naval targets. (See FM 44-10 and 44-21, when published.)

d. **Emergency fire control.** A system of emergency fire control is used if the normal methods in b above are not possible. A standard emergency system is described in FM 44-21. It employs plotting boards and obtains present position data from any source available, such as adjacent batteries or the AAOR.

14. VOLUME OF FIRE. In order to obtain the volume of AA fire necessary for prompt effect, the gun battery is

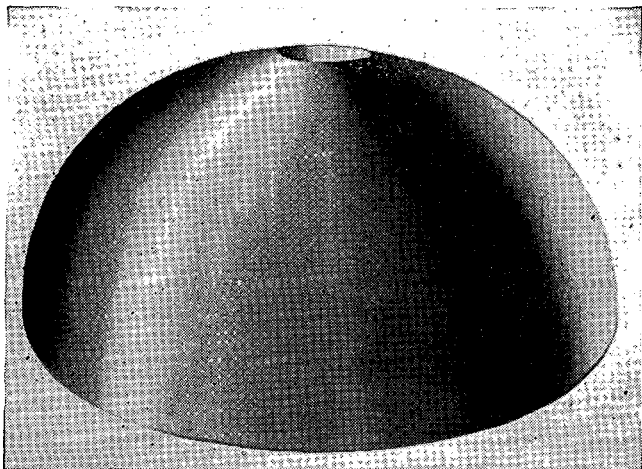

Figure 6. A graphic representation of the field of fire of a 90-mm gun using M9 director.

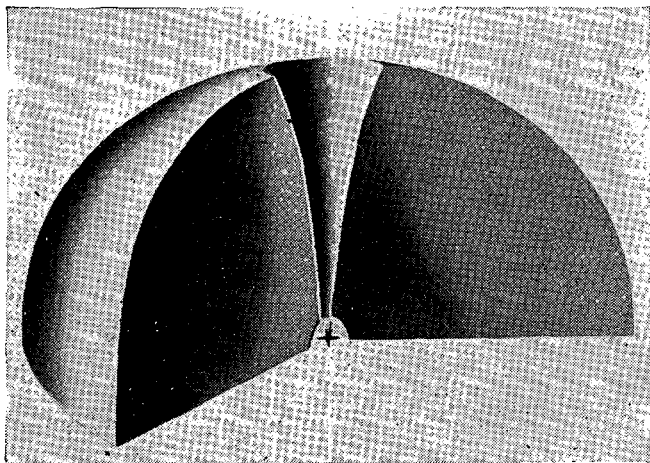

Figure 7. A graphic representation of cross section of field of fire of a 90-mm gun. The dead areas as shown are those using the M9 director.

employed as the fire unit. The necessary concentration of fire is obtained by a coordinated use of the proper number of fire units.

15. MACHINE GUNS. The caliber .50 machine gun is standard local defense equipment for AAA gun units. It has a maximum ground impact range of about 7,500 yards. Its effective range is 600 yards and is dependent upon the gunner's depth perception. Present tracer ammunition has a burn-out range of about 1,850 or 2,450 yards depending on the type of ammunition.

16. AMMUNITION. a. Classes. The principal classes of service ammunition for AAA guns are high-explosive (HE), armor-piercing (AP), and armor-piercing-capped (APC). They are loaded with two types of propelling charges:

(1) FNH (flashless, nonhygroscopic) powder, which contains ingredients that greatly reduce muzzle flash. However, it produces a considerable amount of smoke.

(2) NH (nonhygroscopic) powder, which produces less smoke than FNH powder, but which does produce a considerable amount of muzzle flash.

b. Uses. For other than AA fire the various classes of service ammunition are suitable for the purposes indicated below:

(1) *High explosive ammunition.* HE shell is ordinarily used against unarmored and lightly armored vehicles or naval vessels, troop concentrations, and ground installations. HE shell is fuzed with either time or point detonating (superquick or delay) fuzes.

(2) *Armor-piercing ammunition.* AP shot and APC projectiles may be used for fire on all types of armored mechanized targets, or fortified positions, or armored naval vessels.

CHAPTER 3

MISSIONS

17. PRIMARY ROLE. The primary role of AAA is to provide local protection for field forces and important ground establishments by attacking all forms of enemy air attack and activities both by day and by night.

18. SECONDARY ROLE. The secondary role of AAA is to attack hostile ground and naval targets.

19. SPECIFIC PRIMARY ROLE. The specific primary role of AAA guns is to attack all enemy aircraft within range, particularly high-flying aircraft, to destroy them, to cause them to abandon their missions, or to decrease the efficiency of their operations.

20. SPECIFIC SECONDARY ROLE. The specific secondary role of AAA guns is to attack and destroy enemy mechanized targets within range, particularly medium and heavy tanks and armored cars; or to carry out general support missions as reinforcing field artillery, antitank artillery, or seacoast artillery. AAA guns may also be used to mark front lines or bomb safety lines by means of marker bursts.

21. PRIMARY VERSUS SECONDARY ROLE. a. Although AAA guns are not primarily designed for fire against ground or naval targets, AAA gun units may be diverted from their primary role and employed in their secondary role. *It is not normal, however, for field commanders to divert gun units from their primary AA role as long as there is a threat of enemy air action.*

b. The appropriate division or higher commander must decide in each case when AAA guns will be diverted from their primary roles and employed in a secondary role. When this is done, AAA guns cannot be expected to provide protection from air attack.

c. AAA, when employed in the AA role, is habitually sited so as to assist, if possible, in the attack of ground and naval targets. In this case, the engagement of ground and naval targets is undertaken *only when such engagement will not interfere with the primary mission, or when ground defense of the AAA unit becomes imperative.*

CHAPTER 4

CONTROL OF FIRE

Section I. General

22. DEFINITIONS OF TERMS. a. **Fire control.** The exercise of the conduct of fire and of fire direction at the fire unit. The fire unit commander directs the technical means by tactical command to control the fire of his unit.

b. **Conduct of fire.** The employment of the technical means to place accurate fire on the target.

c. **Fire direction.** The exercise of tactical command over one or more fire units in the selection of targets, in the appropriately timed concentration or distribution of fire thereon, and in the restriction or release of fire. Fire direction may be exercised by the fire unit or higher commander.

23. FIRE DIRECTION. a. **General.** (1) Fire direction normally is exercised by the fire unit commander. This responsibility may be delimited and defined by commanders higher than the fire unit commander.

(2) Because of the great speed and maneuverability of aircraft, the degree of fire direction that can be exercised by higher command depends to a large extent upon the efficiency of the warning service. The extent of the intelligence net is, in turn, related to the size and permanency of the defense.

(3) In rapidly moving situations, or where one group defends an isolated objective for only a short time, it is not expected that the warning service will be elaborate. On the other hand, where one or more groups or brigades are emplaced in the defense of vital permanent establishments, a high degree of efficiency is expected.

(4) It is necessary to discuss the problem of fire direction for at least these two extreme conditions. In other situations, which fall somewhere between the extremes, the system of fire direction which best meets the needs of the moment will be chosen.

b. Direction by fire units. In a rapidly moving situation fire direction is exercised by the fire unit commander, except when higher commanders have exercised some fire direction by the issuance of prior general instructions or SOP, which should be simple and incapable of misconstruction.

c. Direction by higher echelons. (1) In a stabilized and highly organized defense, and in some moving situations, a greater degree of fire direction can be exercised by higher echelons and coordinated under a centralized agency, normally the AAOR.

(2) This fire direction by higher echelon is exercised to supplement and assist the fire unit commander in the performance of fire direction where it appears necessary in order to exert the maximum strength of the whole defense. This can be done prior to and during the attack.

(3) Centralization of fire direction during combat requires an efficient warning system and reliable communication net. (See FM 44-8.) In all but the most rapidly moving situations aircraft warning service, which is operated by air forces, should be available to AAA. Information regarding its operation and establishment, and instructions for its coordination with the AAAIS, should be incorporated in the defense plan.

(4) In centralized fire direction, the size, location, and course of an attack is plotted as the aircraft approach the vicinity of the defended area. The AA operations officer issues such orders as are necessary for the employment of the guns of the defense to best advantage.

d. Restrictions on fire. Restrictions on AAA gun fire are necessary in order that friendly aircraft, and in some instances friendly troops and ground installations, are not unnecessarily endangered.

(1) Theater commanders are responsible for establishing uniform procedures for restrictions of AAA fire to prevent undue danger to friendly aircraft within their commands.

(2) Commanders of all AAA echelons are responsible that the fire of their units does not unnecessarily endanger friendly troops and ground installations.

(3) The AAA fire unit commander in immediate command is responsible for opening and closing fire, unless fire is restricted by higher authority. He is the individual responsible for determining when friendly aviation is unnecessarily endangered by the fire of his unit, unless action is restricted by higher authority.

(4) The normal firing status of AAA guns will be that of "Release to open fire under instructions contained in local SOP," until specifically restricted.

(5) Restrictions will be imposed on the minimum number of AAA units consistent with the accomplishment of the desired aim. This restriction will be imposed for a specific purpose and for a definite period of time.

(6) See FM 44-1 for further details.

e. AAAIS. (1) The AAA commander is responsible for the operation and installation of the AAAIS.

(2) For functioning of AAAIS, see FM 44-8.

f. AAOR. An AAOR (AA operations room) is set up and operated in each AAA defended area by the highest AAA headquarters in the area. The magnitude of the AAOR and the extent of the set-up varies according to the size and the permanency of the defense. In situations where the defense installation is large, an AAA operations detachment may be provided to operate the AAOR. When an AAA operations detachment is not attached, the same principles apply but operating personnel are drawn from the units of the AAA defense.

(1) *Command.* The AAOR is under the command of the AAA defense commander.

(2) *Functions.* (a) To collect, evaluate, and disseminate intelligence.

(b) To exercise fire direction when and as necessary.

(c) To perform certain necessary routine functions.

(3) For details of operation and personnel, see FM 44-8.

Section II. Guns

24. **FIRE CONTROL DOCTRINE.** Considering the capabilities of the AAA guns and the characteristics of aircraft, certain fundamental doctrines can be deduced.

a. Targets within range must be brought under fire with the greatest possible speed, unless fire is restricted by higher authority.

b. Every effort should be made to secure hits with the opening rounds.

c. The maximum volume of fire should be employed.

25. TARGET PRIORITIES. Target priorities in normal and contingent sectors (par. 47) normally will be dictated by higher command or SOP. Within these limitations, the fire unit commander makes the actual selection of targets. He is guided when designating targets by the following principles:

a. When two or more targets enter the field of fire of a fire unit, fire is opened on that target which offers the *most dangerous threat* to the mission of the AAA defense.

b. When two or more targets offer equally dangerous threats, that target which is not under the fire of other AAA fire units is engaged first.

c. Paragraph 23d.

d. Correlating a to c above, the greatest possible number of targets are taken under fire by an AAA defense.

e. Basically the fire fight is the fire unit commander's action. Except for previous indoctrination by SOP and specific restriction or direction by the AAOR, the fire unit commander controls and directs the fire fight. After the fire fight is engaged the action is so fast that fire direction is localized in the fire unit commander. It is therefore the battery commander's responsibility to engage effectively. His decision is based upon previous indoctrination and upon the current information of the location of enemy flights supplied and maintained up-to-date by the AAOR.

26. BATTERY COMMAND POST. The battery command post is equipped with all the instruments and equipment necessary to conduct, control, or direct fire by any of the methods used. This equipment includes the necessary plotting board, tables, scales, the remote data indicators of the radar, and the communications equipment (radio and

telephone) for reception of AAOR and AAAIS information as well as for control of the battery.

27. TYPES OF FIRE. a. AAA gun fire units may engage enemy air targets with one of the following types of fire for effect, depending upon the necessity for the particular type and the tactics of the enemy air force.

(1) *Continuously pointed fire.* This is the normal method of AAA gun fire. Fire control instruments track the target and transmit firing data continuously to the guns. Fire is continuous and at maximum accurate rate.

(2) *Predicted concentrations.* A method of fire by which the future position of the target is predicted by present position plots. A stipulated number of rounds are fired at each predicted point. This is an emergency method of fire control.

(3) *Barrage fire.* A method of fire having for its purpose the placing of a barrier or curtain of fire across the probable course of the enemy aircraft. Fire, based upon predetermined firing data, is directed at preselected barrage points for a stipulated number of rounds or period of time. This is an emergency method of fire control.

b. The conduct of these types of fire may be by director control using visual or radar data at seen targets, director control using radar data at unseen targets, or barrage fire at predetermined points in the sky. Emergency methods are used in the event of equipment failure. Instructions on these methods of conducting fire are published in FM 44-10 and 44-21.

28. RATE OF FIRE. The rate of fire to be delivered by AAA guns must be the maximum *accurate* rate permitted by the matériel.

CHAPTER 5

COMMUNICATIONS

Section I. General

29. **GENERAL.** AAA communications comprise all the means employed to transmit orders, intelligence, and commands between AAA gun units and for liaison with units of the other arms and services. The basic means of communication available to all types of AAA gun organizations are wire (telephone), radio, and messenger. Wire is the primary and most dependable means of communication, and every effort is made to utilize it to the fullest extent. The tactical situation dictates the method and the utilization of the means or combinations of means that accomplish the desired result. In static employment, the communication system is as elaborate as time and material permit. In mobile employment, the minimum requirements for efficient accomplishment of the mission govern the extent of the system. Radio is an auxiliary means of communications. Full use of its capabilities is made in the initial stages of an operation, in rapidly moving situations, and in the event of wire failure or inadequacy.

30. **COMMUNICATION DISCIPLINE AND PROCEDURE.** See FM 11-5, 24-5, 24-6, 24-10, 24-18, and 44-1.

Section II. Radio Communication

31. **GENERAL.** Of the various types of radio sets now authorized for issue to AAA gun units, some are intended for command purposes and others are intended to be used for intelligence purposes (AAAIS). In cases of emergency these sets may be interchanged. No provision is made for administrative radio nets. Administrative messages are transmitted by telephone or messenger.

32. **UNIT RADIO SYSTEM.** a. AAA brigade (see fig. 8 and FM 44-1).

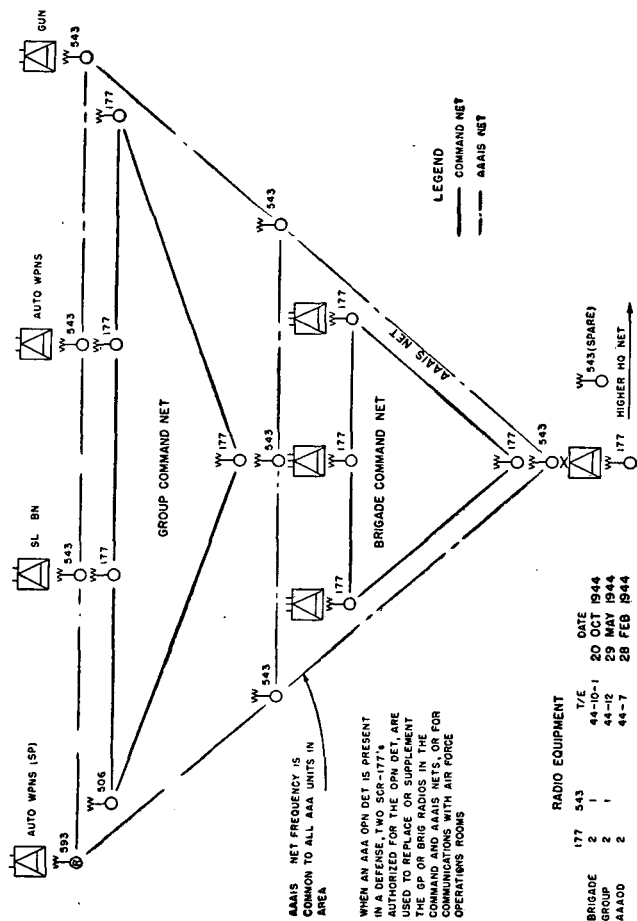

Figure 8. Brigade and group command and AAAS radio nets.

b. AAA group (see fig. 8 and FM 44-1).

c. AAA gun battalion (see fig. 9). (1) *Use of radio set SCR-177.* The SCR-177 is used in the command net from the next higher headquarters.

(2) *Use of radio set SCR-543.* The battalion headquarters battery has two of these sets. One of the SCR-543 sets in battalion headquarters is used for a command net with the component batteries of the battalion. The other SCR-543 set is used in the AAAIS net for warning purposes to the elements of the battalion. Each of the four batteries has one SCR-543 set for use in the battalion command net.

(3) *Use of radio set SCR-593.* This receiver is used at each of the four gun battery command posts for receipt of warning messages transmitted by any element of the AAAIS net.

d. AAAIS and AAOR. For detailed information on the employment of radio communications, see FM 44-1 and 44-8.

Section III. Wire Communication

33. GENERAL. a. *Equipment allotted.* A minimum of wire communication equipment is allotted to AAA units by Tables of Equipment. These allowances provide only enough equipment for lines between essential command posts and, within the batteries, for interior lines necessary for fire control of the various elements. Additional equipment may be drawn when needed from Signal Corps supply depots as authorized by competent authority.

b. *Mobile situations.* When AAA is in a mobile role involving frequent changes of position, radio communication is used initially. The laying of wire consistent with existing conditions is accomplished as expeditiously as possible.

c. *Static situations.* In static situations the wire communication system is as complete and extensive as time and material permit. An elaborate communication net is required for the intelligence service as well as for administration, conduct of fire, and local security. The amount

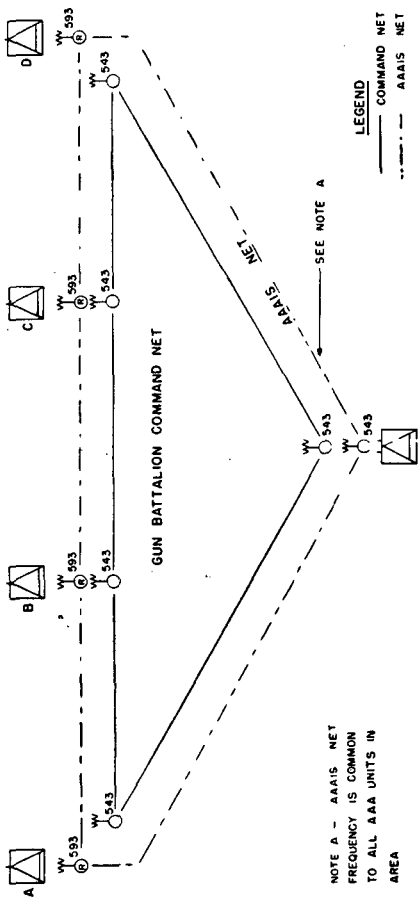

RADIO	EQUIPMENT	T/E	DATE
6N HQ	177 543 593	2	44-16 17 NOV 44
BATTERY "A"			44-17 17 NOV 44
BATTERY "B"			
BATTERY "C"			
BATTERY "D"			
		6	

Figure 9. Gun battalion command and AAAIS radio nets.

of field wire laid and maintained must be reduced by the maximum possible use of existing commercial facilities.

d. **Field artillery role.** When acting as field artillery, the AAA battalion is normally connected by wire with the field artillery fire direction center (FDC); the AAA batteries are connected with the AAA battalion fire direction center. If the AAA battery is acting independently, it is connected directly with the field artillery fire direction center. The field artillery is responsible for establishing wire communication to the AAA unit. If radio communication is used, the AAA unit sends a radio set and operators to the field artillery unit.

34. UNIT WIRE COMMUNICATIONS. Within each unit, lines are normally laid from the command post to the command posts of subordinate elements and to the service elements of the unit. In addition, the lines necessary for fire control and local security are established within each unit. No attempt is made here to set up standard wire communication nets that take care of all eventualities. Each situation must be individually treated. The SOP in each unit should include the number of communication lines to be laid and their priority in various situations. The higher echelon is responsible for installing wire lines to the lower.

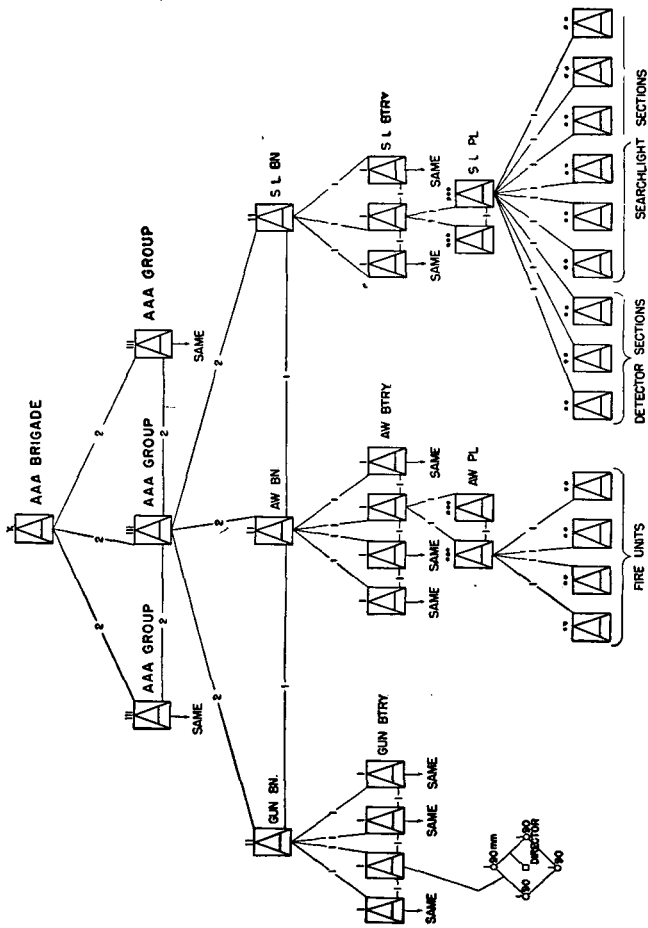

Figure 10. Wire nets used in AAA for command purposes.

CHAPTER 6

EMPLOYMENT OF AAA GUNS

Section I. General

35. TYPES OF EMPLOYMENT. Employment of AAA guns may be divided into static and mobile. The principles of employment are essentially the same in each case.

a. **Static employment.** The term static employment is used to denote the AAA defense of permanent or semi-permanent objectives. Such objectives may be located in the combat zone, communications zone, or zone of the interior.

b. **Mobile employment.** The term mobile employment is applied to the AAA defense of ground combat forces, such as armies, corps, and divisions, in a moving situation. Although mobile AAA gun units are suitable for static or mobile employment, the semimobile units are suitable only for static employment, unless additional transportation is provided.

36. SIZE OF OBJECTIVE. a. The size of the area to be defended affects the manner in which the defense is planned. Against small or precision objectives an attacking bomber generally must fly a rectilinear course during the bombing run so that the bomb sight can be used to the best advantage.

b. As the size of the defended area increases, or as a greater number of precision objectives are presented within a general area, the necessity for careful bomb sighting diminishes. Under these conditions the attacking aircraft can take action to avoid AAA fire by maneuvering and still release their bombs on the area with good assurance that some of the more important objectives will be hit.

c. AAA gun objectives may be classified as small objectives, large areas, and multiple objectives.

(1) A small objective is an objective less than 2,000 yards in diameter.

(2) A large area is an objective greater than 2,000 yards in diameter, all parts of which are of equal importance.

(3) A multiple objective is an area greater than 2,000 yards in diameter, and containing a number of objectives.

37. BASIS FOR TACTICAL EMPLOYMENT. Tactics of AAA guns must be based upon the current characteristics and tactics of enemy aviation, and full consideration of the powers and limitations of weapons of the defense. The continued development of military aircraft with increasing speed, altitude, and radius of action will have an influence upon the future employment of AAA guns. Certain factors, however, seem likely to remain unchanged, of which the most important are as follows:

a. Targets the enemy is most likely to select are those most valuable to the defender, the destruction of which would materially aid the attacker in accomplishing his aims or reaching his objectives.

b. Bombardment aircraft normally depend on reconnaissance aircraft for information of suitable targets, thus making the defeat of hostile reconnaissance aircraft of the utmost importance in some situations. In other situations, firing on reconnaissance aircraft will disclose to the enemy the strength and disposition of the ground installations. In general, target priorities will vary according to the particular situation.

c. The short period of time required for aiming operations in all types of bombardment attack will restrict maneuvering to some degree, if accurate results are to be obtained. This restriction may include altitude, speed, and direction of flight, or only, as in dive or glide bombing, the direction of flight.

d. The effectiveness of an AAA gun defense may be judged by its capacity to destroy enemy aircraft, to cause them to abandon their mission, or to disturb the bomb sighting operations. When employed in conjunction with friendly fighter aircraft, the AAA guns may also be effective in breaking up enemy formations.

e. An all-around defense must always be provided.

f. The most economical distribution of the available

matériel is necessary, in order that the most important elements or localities may be defended against air attack.

g. Defense is provided for critical areas or installations according to importance as indicated in a priority list established by higher headquarters.

h. Normally, at least one battalion should be used in the defense of a single objective.

38. BOMB RELEASE LINE. a. The bomb release line is an imaginary line around a defended area or objective over which a bomber traveling toward the area at a constant speed and altitude, should release its bomb to have it strike certain parts of the defended area. The location of this line varies primarily with the speed and altitude of the bomber.

(1) The *initial* bomb release line (IBRL) is an imaginary line around an objective over which the attacking bomber must release his bombs to hit the *near* edge of the objective. (See fig. 11.)

(2) The *final* bomb release line (FBRL) is that over which a bomb released will strike the *far* edge of the objective. (See fig. 12.)

b. The location of the bomb release line is determined by two factors, the time of fall of the bomb and the speed of the aircraft.

(1) The time of fall of a body in a vacuo, when it starts with a zero vertical velocity, is given by the formula

$$t = \sqrt{\frac{2H}{g}}$$

where t is the time in seconds, H is the altitude of release in feet, and g is the acceleration due to gravity, approximately 32.16 feet per second per second. This will give, for altitudes of 10,000, 15,000, 25,000, and 30,000 feet, times of fall of approximately 25.0, 30.5, 39.4, and 43.1 seconds, respectively. It should be remembered that air resistance will have an effect upon these figures in actual bombings but, since the speed and altitude of an attack cannot be forecast accurately, they may be considered sufficiently accurate for the use intended.

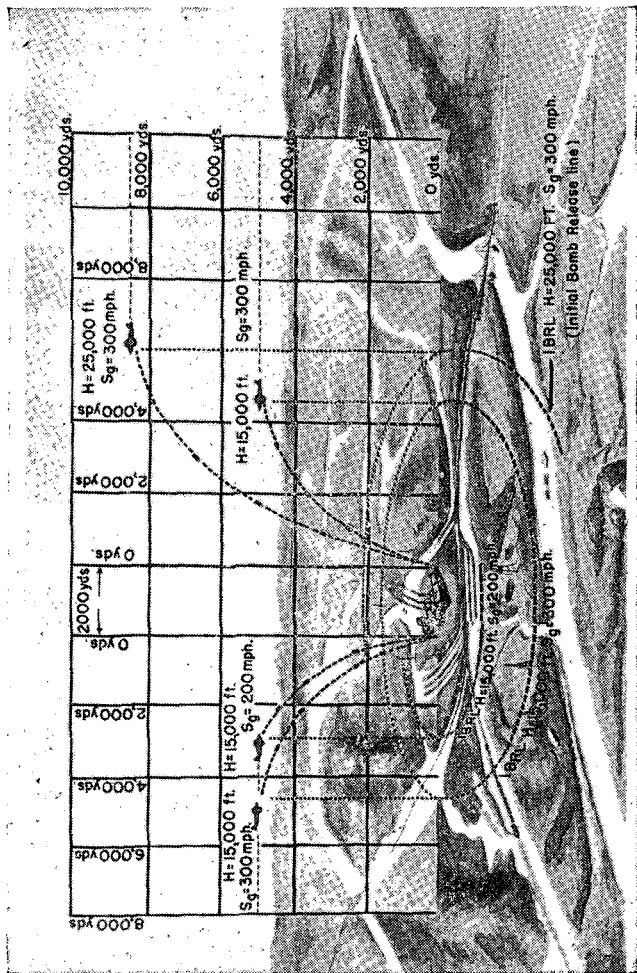

Figure 11. Influence of speed and altitude on initial bomb release line.

(2) The horizontal range from the point of release of the bomb to the point of impact is approximately equal to the time of fall of the bomb multiplied by the speed of the aircraft. These values for different times of fall and speeds of aircraft are given in appendix I. (An approximate rule for determining the time of fall in seconds is to add the whole number 15 to the altitude in thousands of feet.)

c. As the size of the objective increases, or as a number of smaller objectives in the area to be defended are increased, the necessity for careful and precise bomb sighting operation decreases (par. 36). There is no sharp line of division between a small objective and a large area, as one merges gradually into the other. It is not accurate to consider that there are any definite bomb release lines in the case of an area larger than 4,000 yards in diameter all parts of which are approximately of equal importance, as the bombs may be released over a wide area with equal effect. When very large areas contain a number of small targets of particular importance, each one will have its individual bomb release line. These lines may or may not merge with those of adjacent small areas.

39. CRITICAL ZONE. a. The critical zone is the area over which the attacking aircraft in horizontal flight or glide bombing maintains a rectilinear course just prior to reaching the initial bomb release line, which flight is continued in the case of trail bombing until the last bomb is released. In the case of horizontal flight bombing, a straight and level course is flown. In glide bombing, a straight course with a constant change in altitude is used. The greatest amount of destruction and neutralization can be expected from gun fire placed on the aircraft while it maintains this rectilinear course required for accurate bomb sighting. The determining factor in calculating the width of the zone is the length of time required for the bomb sighting operation. The following factors bear on the length of the bombing run: Ability of the bombardier, the bomb sighting equipment; conditions of visibility; size and type of target; ease of identifying target; distance from a suitable aiming point; size and type of bombard-

ment formation; and quantity, depth, and accuracy of AAA in the target area. Bomb sighting times may vary from about 20 to 30 seconds at altitudes up to 10,000 feet, to 1 to 2 minutes at higher altitudes using visual means, and up to several minutes using radar bomb sighting.

b. For tabulation of widths of critical zone for horizontal flight method of attack with various bomb sighting times and speeds of airplanes, see appendix I. In the case of trail bombing, these distances are increased by the travel of the plane from the time the first bomb is released until the last bomb is released.

c. As the size of the area increases, the necessity for lengthy and careful bomb sighting diminishes. Consequently, there is little or no necessity for any appreciable period of rectilinear flight. It follows that it is not accurate to consider that any "critical zone," in the sense used above, exists for such cases.

40. FIRST BURST LINE. a. The assumption that a critical zone does exist implies that the attacking aircraft may be maneuvered until the outer limit of the critical zone is reached. The aircraft may be tracked before it reaches the outer limit of the critical zone but accurate firing data are not available until the bomber assumes its rectilinear bombing run.

b. After the bomber crosses the outer limit of the critical zone and begins the bombing run, approximately 10 seconds are required before smooth and accurate data are available at the guns. The first burst will therefore be fired at the future position of the target when the target has been on its bombing run for 10 seconds. During the time of flight of the projectile, the aircraft will advance towards the IBRL a distance equal to the time of flight of the projectile times the speed of the aircraft. The sum of the 10 seconds required for the director to settle down and the time of flight of the projectile, multiplied by the speed of the aircraft, establishes the first burst line. The first burst line may lie as far inward as 70 percent of the width of the critical zone, depending upon the speed and altitude

of the airplane and the time of flight to the predicted position.

c. In the case of large, massed bombardment formations, the assumption that a critical zone exists is not necessarily true. Large bombardment formations are not readily maneuverable and normally maintain formation in order to utilize the maximum defensive fire power against fighter aircraft. Thus, in some cases large formations may be expected to maintain rectilinear flight long enough prior to reaching the IBRL and FBRL so that smooth, accurate firing data are available out to the maximum fuze range of the guns. This would result in the first burst line being at maximum fuze range and permit engagement of the hostile formation for the longest possible time.

d. The position of the first burst line therefore depends upon:

(1) The speed and altitude of the attacking aircraft.

(2) The length of the period of rectilinear flight prior to reaching the IBRL. This period may vary from 20-30 seconds to several minutes, depending on the bomb sighting time and whether or not evasive action is taken prior to starting the bombing run.

(3) The time required after the initiation of rectilinear flight before smooth, accurate data are available at the guns.

(4) In some cases, the limiting capabilities of the guns, ammunition, and directors as to:

(a) Maximum fuze range.

(b) Maximum horizontal or slant range which the director can utilize for computation.

(c) Maximum altitude which the director can utilize for computation with visual tracking.

(d) Maximum target speeds which the director can accommodate.

(e) Items (b) and (d) above are more critical with the M7 director than with M9 (M10) directors.

41. BASIC CONSIDERATIONS IN ESTABLISHMENT OF GUN DEFENSE. The following basic con-

siderations affect the tactical employment of AAA guns against bombardment aviation:

a. *The capabilities and limitations of the matériel must be known in order to employ it efficiently.* For tactical planning, a safety factor is introduced by the use of less than the maximum capabilities. The maximum fuze range of AAA gun ammunition is 30 fuze numbers, but experience indicates that a fuze range of 25 fuze numbers should be used for planning. The maximum quadrant elevation of AAA guns is 80° , but for purposes of planning an angular height of 75° is considered the maximum.

b. *A defense must be capable of exerting its power against attack from any direction.* This implies an equal spacing of available batteries around the objective wherever possible. Some modification of such equal distribution may be necessary because of local terrain. When battery sites cannot be occupied in advantageous locations, there should be compensation for the occupation of unfavorable locations by the use of a greater number of batteries in the weak sector or by allotment of batteries of greater range, if available. This situation is particularly acute when the defended area closely borders a large body of water, or when terrain limits the adequacy of radar sites and the effectiveness of friendly fighter aircraft.

c. *Batteries should be within mutually supporting distances.* This distance will depend upon the horizontal range of the weapons at the maximum expected altitude of the hostile attack, using a fuze setting of 25 as the limiting factor, and the distance between adjacent batteries should be less than the horizontal range at that altitude. This distance has been arbitrarily set at 6,000 yards, and assures that one battery's field of fire will overlap the dead area of an adjacent battery. Batteries should not be located more than 6,000 yards apart. When batteries are grouped densely and closely around the objective, a larger percentage of air attacks can be fired on. However, dense grouping also makes the batteries more vulnerable to neutralization.

d. *No single arrangement of guns will provide the maximum possible defensive strength under all conditions and*

forms of enemy attack. In general, the defense must be established upon an estimate of the most likely forms, speeds, direction, and altitudes of attack. This will depend upon the tactics of the enemy, the nature, size, and importance of the defended objective, the local terrain, the weather conditions, and similar factors.

(1) In some localities, where the winds are generally unvarying in direction, the normal attack approach will be "down wind."

(2) The availability of initial points for the bombing run may indicate the likely directions of approach. An initial point will be a clearly defined point near the target, which because of its relation to the target, make identification of the target area certain. It may be a river, an inlet or small harbor on the coast, a town, a railway or railway intersection or a lake, at a distance of 2 to 5 minutes of flying time from the objective. An initial point for radar bombing also must be capable of returning a strong, distinctive signal. Initial points lying on a straight line from the home base of the aircraft to the objective normally are not selected.

(3) Likely directions of approach may also be indicated by terrain features which hamper radar detection in certain sectors. The enemy may be expected to take advantage of any such features to avoid radar detection.

42. NUMBER OF BATTERIES IN GUN DEFENSE.

The number of batteries which should be provided for the AAA defense of an area cannot be determined with mathematical exactitude. The provision of any number, no matter how great, will not be a guarantee that the defense can repel all attacks which might be brought against it. Gun density is the number of guns which may be brought to bear on a given target and is increased by siting batteries so that their fields of fire overlap for mutual support. A minimum density of from 8 to 12 is desirable over the inner half of the critical zone. The density should increase as the bomb release line is approached. Generally, the relative strength of a defense is in direct proportion to the number of batteries allotted. Among the many factors

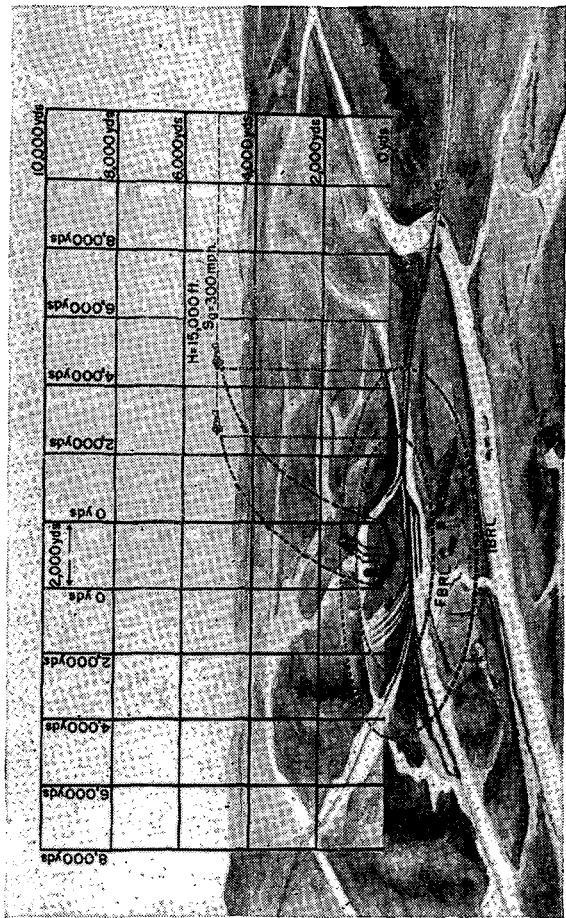

Figure 12. Initial bomb release line (IBRL) and final bomb release line (FBRL) about an area 2,000 yards in diameter for a target traveling 300 miles per hour at an altitude of 15,000 feet.

which must be considered in deciding upon the number to be allotted are the following:

a. Value of the objective to the defenders and the advantages which would accrue to the enemy by its destruction. This will affect the extent of the enemy effort both in numbers and in risk taken. A defense suitable for one objective may be entirely inadequate for another of the same size. The importance of a given objective may change with the passage of time so that a later strengthening of that defense may be necessary or a weakening permissible.

b. Relative strength of the opposing air forces.

c. Location of friendly fighter airdromes and the effectiveness of fighter action.

d. Location of actual or probable hostile air bases.

e. Presence or absence of other friendly AAA defense areas, balloon barrages, and area smoke screens.

f. Size, shape, and nature of the objective to be defended.

g. Nature of the terrain about the objective, particularly the proximity of large water areas or of terrain features which hamper radar detection.

h. Relative importance of providing some protection to other areas and total amount of AAA which may be available or obtainable.

43. CONSIDERATIONS IN LOCATION OF BATTERIES ABOUT AN OBJECTIVE.

a. The following variable factors must be considered in determining the location of gun batteries about an objective:

(1) The expected altitude and speed of hostile bombing attacks.

(2) The expected length of hostile bombing runs.

(3) The evasion action, if any, taken by hostile bombardment aircraft prior to starting the bombing run.

(4) The action taken by hostile aircraft when subjected to the first burst. The aircraft may disregard the AAA fire and continue on the bombing run, take avoiding action and try a new run, or give up his mission and return to his base.

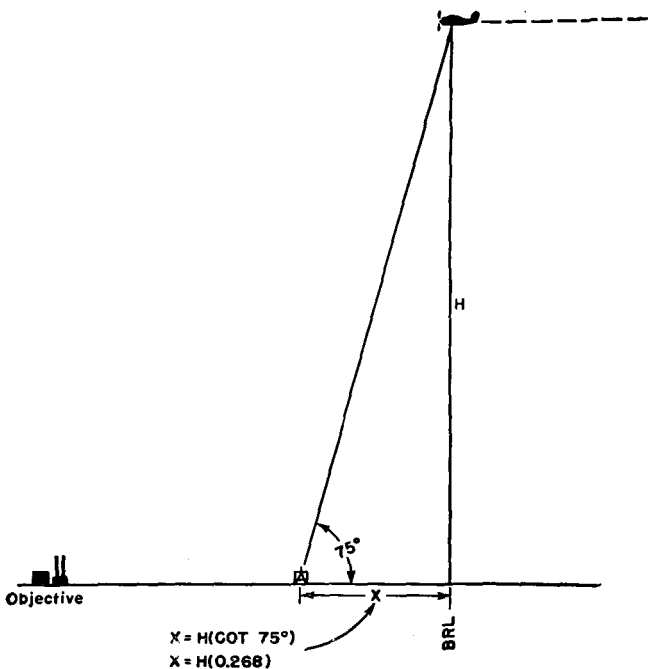

Figure 13. The method of determining the radius of the dead area of a battery.

(5) Whether all of the bombs are dropped at the IBRL or the bombing is continued until the FBRL is reached.

b. Consideration must be given by the fire unit commander to the possibility of successive attacks within a given sector. The commitment of the fire of the defense on some feint or subsidiary attack while the main effort fails to receive its proportionate share of the fire must be prevented. Fire must be distributed so the maximum number and the most important targets receive a proportionate share of the fire. In order to accomplish such an end, some measure of fire direction over the priority of batteries in engaging targets must be exercised. Such direction may be exercised by indoctrination and standing operating procedure or from the AAOR.

44. LOCATION OF GUN BATTERIES ABOUT AN OBJECTIVE. a. **General.** In determining the positions of batteries about an objective, it is necessary to assume certain conditions of hostile attack. It is also necessary to decide whether gunfire should be placed on the target until it reaches the FBRL or only until it reaches the IBRL. *In this example, the following assumptions are made:*

(1) Each battery will be assigned a normal and a contingent sector. Only the possibilities of fire in the normal sector of a battery will be considered.

(2) The batteries will consist of four 90-mm guns firing HE shell M71, with 30 fuze number mechanical time fuze.

(3) For planning purposes, effective fire is assumed to be limited by a 25 fuze number range, and an angular height of 75° .

(4) The enemy attack will be made at a speed of 300 miles per hour and at an altitude of 15,000 feet.

(5) The attacking aircraft will maneuver until 30 seconds before the first bomb is released and will take avoiding action immediately after the last bomb is released.

(6) The attacking aircraft will drop their bombs between the IBRL and FBRL.

(7) A battery must be able to engage the hostile air-

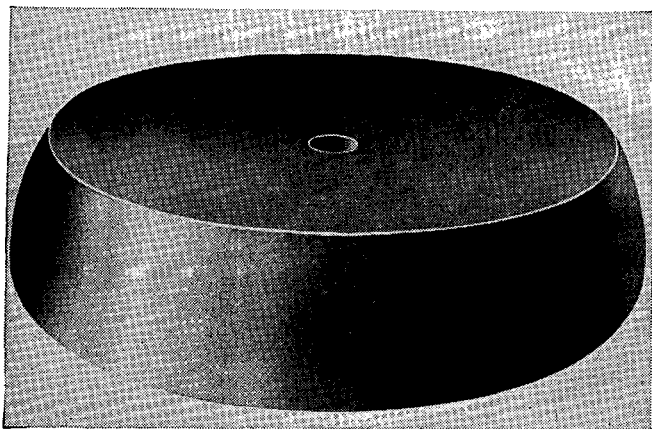

Figure 14. A graphic representation of the field of fire of a 90-mm gun below an altitude of 15,000 feet using the M9 director.

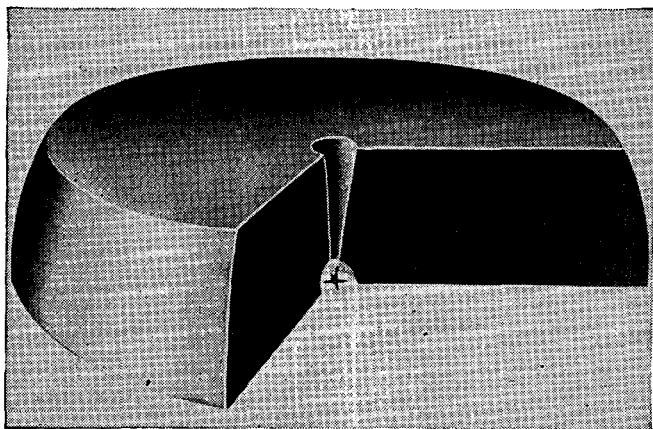

Figure 15. A graphic representation of the cross section of field of fire of a 90-mm gun below an altitude of 15,000 feet. The dead areas shown are those using the M9 director.

craft up to the FBRL on an incoming course passing directly over the battery.

b. Procedure. (1) *Determination of IBRL and FBRL.* The distance of the IBRL from the edge of the objective is determined by the altitude and speed of the hostile aircraft. The altitude of the aircraft determines the time it takes the bomb to drop from the aircraft to the ground. In this example, the altitude of the aircraft is assumed to be 15,000 feet and the time of fall is 30.5 seconds. The distance of the IBRL from the edge of the objective is determined by the speed of the aircraft in yards per second times the fall of the bomb in seconds. This is 150 yards per second times 30.5 seconds or 4,575 yards. (This value can be obtained from appendix I.) The distance of the FBRL from the IBRL is equal to the diameter of the objective, or 2,000 yards. Figure 12 shows the location of the IBRL and FBRL for the above conditions.

(2) It is necessary at this point to refer to the limits of fire, as originally shown in figures 6 and 7. These two figures show the limits of fire up to the maximum altitude. As the altitude of the aircraft in this example is 15,000 feet, it is necessary to consider the limits of fire at that altitude. Figure 14 shows the outer limits of fire, and figure 15 shows both the inner and outer limits of fire for this altitude.

(3) Since it is desired to engage the hostile target until it reaches the FBRL, the gun battery's position must be such that its dead area is tangent to the FBRL. The radius of the dead area for the battery, for any expected altitude of attack, is easily calculated. As previously stated, a maximum angular height of 75° is used for planning purposes. With this, and the expected altitude of attack, a right triangle relationship is set up to determine the distance inward from the FBRL to place the battery in order that the target may be engaged up to the last point at which it can accomplish its mission. Figure 13 shows that by using the cotangent of 75° , a formula may be derived for the radius of the battery dead area or, in other words, the distance inward from the FBRL that the battery should be sited. This formula is $X = 0.268 \times H$. By applying the ex-

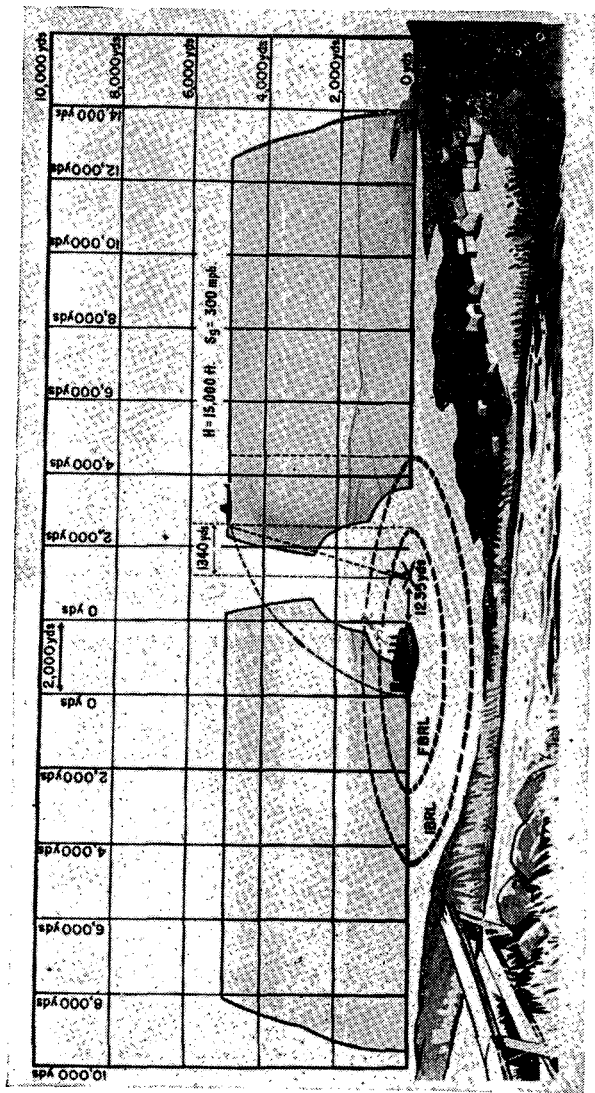

Figure 16. Location of gun battery in protection of a small objective. (The vertical projection indicates the limiting ranges using the M7 director.)

ample in a above to this formula, the distance is found to be 1340 yards. The gun ring, or 75° line, is thus 1340 yards inward from the FBRL. Note that the radius of the dead area is a function of altitude. The location of the battery from the edge of the objective is determined mathematically as follows: The distance between the IBRL and FBRL is equal to the width of the objective or 2,000 yards. Therefore, the distance from the edge of the objective to the FBRL is 4,575 yards minus 2,000 yards, or 2,575 yards. The radius of the dead area at 15,000 feet is 1,340 yards. Hence 2,575 yards minus 1,340 yards equals 1,235 yards, the distance from the edge of the objective to the gun battery. (See fig. 17.)

(4) The location of the first burst from the initial bomb release line is determined (fig. 19) in the following manner: The bombing run of the target has been assumed as 30 seconds. Therefore, the bomber will cease evasive action and begin his bombing run at a point 30 seconds times 150 yards per second or 4,500 yards from the IBRL. After the target has entered on the bombing run, 10 seconds are required before the rates in the director settle down and the data are flowing to the guns. The first burst, therefore, is fired at the future position of the target when the target has been on its bombing run for 10 seconds. By successive approximations, the time of flight to this future position is determined to be 11.4 seconds. The aircraft has now been on its bombing run for 11.4 plus 10 or 21.4 seconds. If the aircraft continues on its bombing run to the IBRL, it will be under fire for 8.6 seconds. If the aircraft should further continue on to the FBRL, it would be under fire for about 13 additional seconds.

c. Figures 16 and 18 illustrate the same problem using the M7 director.

d. It should be noted that in the above problem:

(1) The period of *rectilinear flight* of the bomber prior to reaching the IBRL would have to be increased to about 82 seconds in order to fire an effective first burst at the limiting 25 fuze number range point used for planning purposes.

(2) An effective first burst could not be fired at 30 fuze

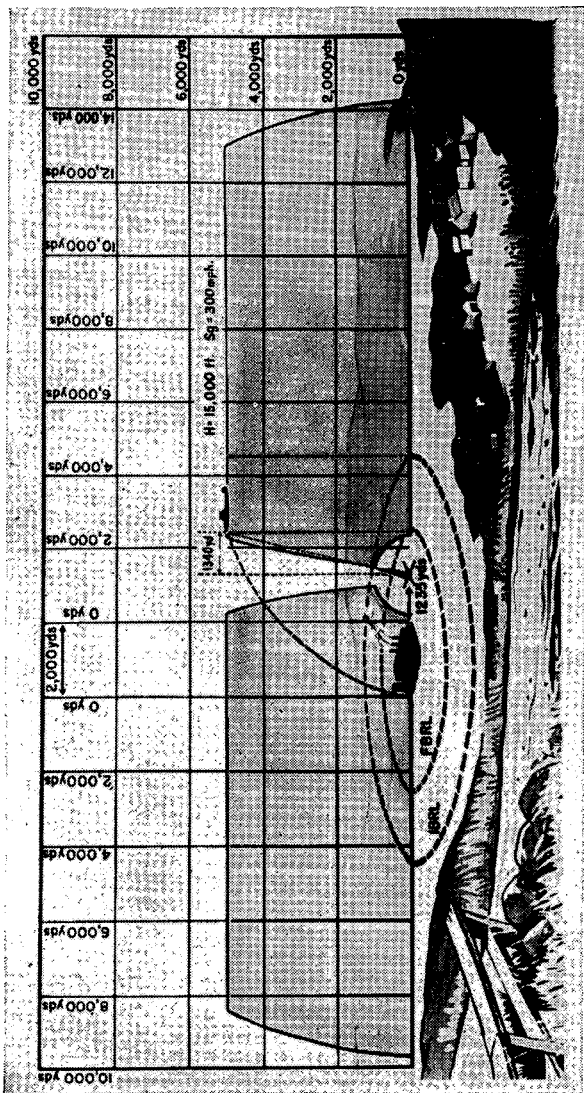

Figure 17. Location of gun battery in protection of a small objective. (The vertical projection indicates the limiting ranges using the M9 director.)

number range unless the bomber maintained rectilinear flight for about 96 seconds prior to reaching the IBRL. Fire at this range could not be undertaken with the M7 director.

e. The above example is for illustrative purposes only. *It is not intended as a standard guide for such a defense.* Each defense must be designed to fit the particular situation.

45. RAPID DETERMINATION OF GUN POSITIONS. a. The study above is for a small objective. As the area of the objective increases a study similar to the one above must be made, considering the possible enemy tactics which may be employed against the objective and the types and number of guns available for the defense.

b. Another important point to bear in mind is that, in the problem above, the bombing altitude was assumed as 15,000 feet. It is possible that the first attack on an objective will be made at this low altitude. If these attacks are subjected to considerable losses due to accurate gunfire, the altitude of the attack will be increased. This increase in the altitude of bombing increases the distances of the bomb release lines from the objective and necessitates a relocation of the batteries. The following form can be used for rapidly calculating the distance that the batteries should be located from the edge of the objective when preparing a defense of a small objective.

Distance from IBRL to edge of objective	_____
Minus distance between IBRL and FBRL (this is equal to the diameter of the objective)	_____
Distance between FBRL and edge of objective	_____
Minus radius of dead area	_____
Distance from edge of objective to battery.	_____

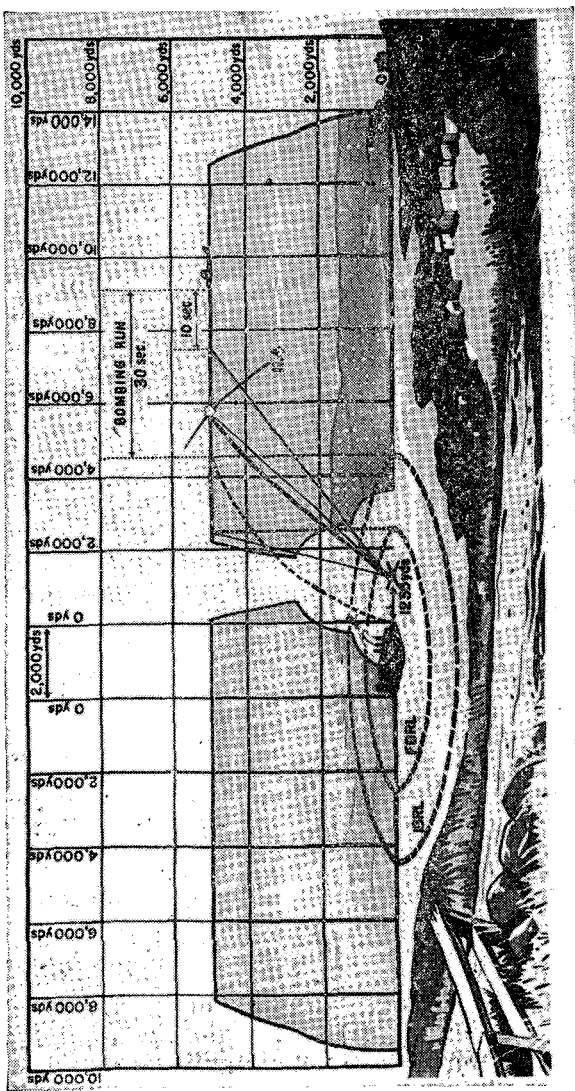

Figure 18. Location of first burst. (The vertical projection indicates the limiting ranges using the M7 director.)

c. The table below gives approximate distances from the edge of the objective to the four batteries of a gun battalion for various altitudes of enemy attack. This table was calculated for a defended area of 2,000 yards in diameter. It may be considered accurate for initial locations about defended areas up to 3,000 yards in diameter. These values are given as a guide and are to be used only in those cases in which time for a complete study of the situation is not available. The method of developing a defense for any set of conditions is as shown in paragraphs 43 and 44. Wherever possible, a complete analysis of the defense should be made following the procedure shown.

Altitude of expected attack (yards)	Distance in yards of battery (75° line) from edge of objective when the expected speed of attack is—		
	250 miles per hour	300 miles per hour	350 miles per hour
3000 yds.....	159	751	1344
5000 yds.....	473	1235	1998
7000 yds.....	637	1539	2442
8000 yds.....	681	1646	2611
9000 yds.....	701	1723	2746
10,000 yds.....	720	1800	2880
11,000 yds.....	715	1843	2980
12,000 yds.....	697	1879	3062

d. It is evident that in the field each situation that develops will be a special situation and will require special treatment. Since the bomb release line is determined by the speed and altitude of the attack, it cannot always be accurately predicted. The position of the BRL is calculated for the highest operational altitude and speed of attack of which the enemy is capable. If sufficient armament is available, batteries are sited in depth to give sufficient gun density to cover a variety of bomb release lines. No tactical treatise, regardless of size, can solve the problem of the commander in the field. However, it is believed that with a knowledge of the range limits of the antiaircraft guns to

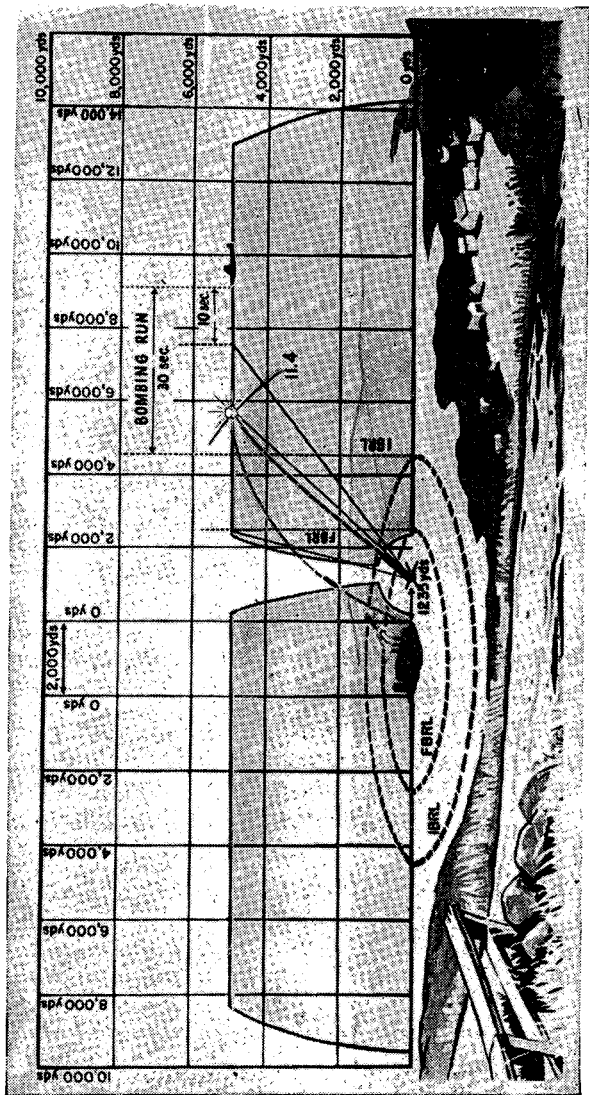

Figure 19. Location of first burst. (The vertical projection indicates the limiting ranges using the M9 director.)

be used, the characteristics of enemy aircraft and their tactical use, and the considerations outlined in paragraph 41 (basic consideration in establishment of a gun defense), the commander in the field can place what armament may be available to him in the positions that will best perform his mission. *The fundamental principle is that it is always better to provide a strong defense for a few areas than to disperse available armament for the defense of many points, to the consequent weakness of all.*

e. Any map analysis of a defense gives only the relative location of the batteries to the objective. The map study must be followed by a reconnaissance of the ground to determine the exact location of the batteries on the ground.

46. EFFECT OF INCREASE IN SIZE OF DEFENDED AREA. As the size of a defended area increases, more batteries will be required about the area to prevent batteries from being separated by more than mutually supporting distances. The coverage of the gun batteries over the center of the objective will decrease and it may be necessary to place some batteries within the area itself, to prevent a complete break in the coverage.

47. NORMAL AND CONTINGENT SECTORS. a. Terrain and expected enemy tactics control the establishment of normal and contingent sectors. For a highly developed static defense, a single coordinated system of development is essential. The same principles apply, whether the defense is large or small, whether it contains many or few units. Coordination is required to the extent that well established normal and contingent sectors are allotted to each fire unit.

b. In all cases it is normal to overlap adjacent assigned sectors.

c. The contingent sector of any battery includes the normal sectors of all the other batteries within range.

d. In all cases, due care is exercised that there is no possibility of confusion because of a sharp cleavage between sectors of adjacent units. Confusion will be reduced by establishing an overlap of sectors.

48. GUN DENSITY. The strength of the defense at any point is proportional to the number of batteries whose fire can be concentrated at that point. The simplest measure of this strength is the "gun-density" at the point in question. In an area covered by the fire of only one battery the gun-density is 4. Two battery coverage produces a gun-density of 8, etc. Transparent templates for each battery are made representing the assumed field of fire. By shifting these "gun circles" around on the map or overlay of the area to be defended, the most desirable locations of batteries, are obtained quickly. Gun densities are read directly and weak spots in the defense are apparent immediately. Planning of defenses in rapidly moving situations is expedited by previous preparation of gun circles for all map scales likely to be used.

49. ANALYSIS OF DEFENSES. a. The gun density method of analyzing the strength of the AAA gun defense is simple, practical, and effective. A more accurate method is the use of the flak analyzer which is described in TM 4-260.

b. A detailed analysis should be made in every situation, to determine the AAA gun positions which will afford the greatest defensive strength. Such an analysis may disclose prevailing winds at bombing altitudes over the defended area which will materially alter the effectiveness and coverage of the AAA defense. The speed of the attacking aircraft will be increased or decreased accordingly if the attack be up-wind or down-wind. It follows as a matter of course that if the speed of the enemy aircraft is affected, the distance of the IBRL, the critical zone, and the outer limits of the critical zone from the objective will change. It will then be indicated that an off-center AAA defense of the objective extending into the wind direction is necessary rather than a uniform defense. If possible, a detailed analysis should be made before positions are occupied. If not, the analysis is made as soon thereafter as time permits, and positions are shifted accordingly.

c. Studies of the capabilities of enemy bombardment methods and matériel may indicate that elongated objectives

are most vulnerable to bombing from certain directions. In such cases, greater gun density should be provided in such directions.

d. Figures 20 and 21 illustrate the practical solution of a typical defense in the field. The legend under the figures is self-explanatory.

50. ADJUSTMENT OF DEFENSE. The "ideal" AAA gun defense of an objective is one which would provide completely effective protection against all types of enemy bombing tactics from any direction of approach. However, because of the limitations of the materiel and the amount of materiel available, this will never be accomplished. Although the initial analysis of the defense has been completed and the most effective defense has been organized, it must be realized that a change in certain conditions will alter or reduce the effectiveness of the defense. Therefore, a new analysis of the defense must be made and the defense modified if necessary to counteract such new conditions. The more important factors which must be borne in mind are:

a. **Enemy tactics.** There are many influencing circumstances which will dictate the tactics to be used by the enemy. The enemy air capabilities in a particular theater will change frequently; therefore, the most accurate information must be obtained and kept up to date concerning the number and location of his bases in respect to the area to be protected, whether he has local air superiority, types of aircraft he employs in the general area, and bombing tactics employed to include altitude of attack, length of bomb run, evasive action, speed and direction of attack. For example, if new high speed aircraft are introduced into the theater, the defense will have to be adjusted accordingly; or, when seasonal changes of prevailing winds at bombing altitudes occur, or, when a new direction of approach is indicated, the defense will likewise require adjustment.

b. **Enemy intelligence.** It is reasonable to conclude that enemy intelligence has developed some method of analysis, comparable to our own flak analysis (TM 4-260). With

this in mind it is to be expected that enemy intelligence in time will gather sufficient information to compute the effectiveness of the defense and determine the direction of approach of subsequent attacks into the target area over the less effective portion of the defense. To preclude enemy intelligence from making such analysis and to confuse or mislead him in his estimation of the strength of the defense, frequent changes in disposition of the AAA guns should be made. Alternate positions which would maintain the maximum effectiveness possible, should be prepared, and occupied as the situation dictates.

51. EMPLOYMENT OF RADARS FOR SURVEILLANCE. a. **General.** Under direction of the anti-aircraft operations room (AAOR) certain radars in the AAA defense are placed on surveillance duty in accordance with prepared schedules. The number of radars actually used depends on the radar coverage of the area. A sufficient number must be employed to insure that the AAOR has complete coverage of the defended area and its approaches. During periods of no action it is normal to divide this surveillance duty equitably among the radars in the defense. Normal surveillance duty period is from 2 to 3 hours. See FM 44-6 and 44-8 for employment of searchlight radars for surveillance.

(1) When it can be foreseen that a battery radar (in a defense of more than one gun battalion) is to be out of service for an appreciable period of time, the radar of one of the battalion headquarters batteries may be ordered to operate directly under control of the battery concerned, or it may be directed to furnish emergency fire control data to the battery. The battalion headquarters battery radar may be moved to the battery position to facilitate battery operation. When a battalion headquarters battery radar operates directly under battery control, it loses its distinctive classification as a surveillance radar. In such situations the AAOR may find it necessary to employ a battery radar to search and report in order to supplement the other battalion headquarters battery radars.

(2) The battalion keeps the batteries informed as to

changes in the status of radars in order that adequate advance preparations may be made by the batteries concerned.

b. Location. (1) *Battalion headquarters battery radar.* Since this radar is used primarily for surveillance it should be sited to avoid clutter and provide maximum coverage. It is not essential that it be located centrally with respect to the battalion.

(2) *Gun battery radar.* These radars are located primarily to perform their missions with the gun batteries. (See FM 44-21.)

c. Communications. The battalion headquarters battery radar is connected by direct telephone line to the AAOR in the same manner as the gun battery radars. No radio set is provided specifically for the inclusion of the battalion headquarters battery radar in the AAOR net. (See FM 44-8.)

d. Priorities. (1) *Battalion headquarters battery radar.* When on surveillance duty at time of the alert, the battalion headquarters battery radar continues on this status. When "off the air" at time of the alert, the battalion headquarters battery radar goes "on the air" immediately, reports to the AAOR, and begins to search in accordance with established SOP.

(2) *Gun battery radar.* (a) When "off the air" at time of the alert, the gun battery radar goes "on the air" and operates according to battery SOP.

(b) When on surveillance duty at time of the alert, the gun battery radar continues on that status until released to the battery by the AAOR.

(c) The primary function of the gun battery radar is to furnish position data to the gun battery. Therefore, the AAOR releases the gun battery radars to the batteries as soon as the surveillance duty has been taken over by the battalion headquarters battery radar.

(d) Gun batteries must be prepared to conduct visual or emergency fire control while their radars are on surveillance duty since the AAOR normally will not release all radars to the gun batteries until the battalion headquarters battery radar has taken over the surveillance duty. In large coordinated defenses, or in smaller defenses when war-

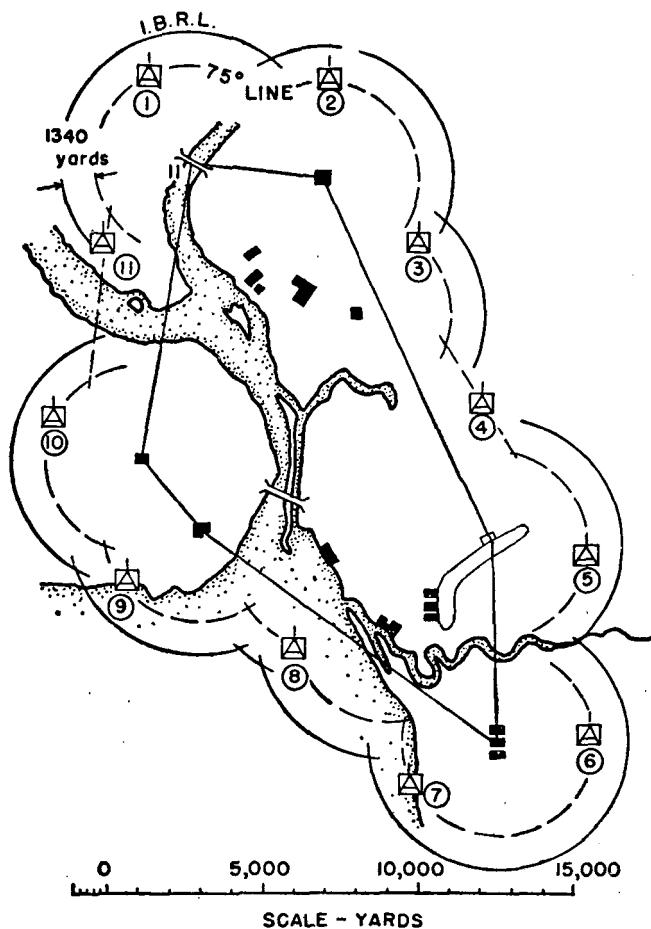

Figure 20. Typical defense of multiple objectives showing IBRL and 75° line around the area with the first stage of planning of gun positions.

ranted by adequate AWS, immediate release of gun battery radars from surveillance duty may be expected. *The status of radars in all defenses is a matter for command decision.*

Section II. Static Employment

52. GENERAL. a. The term "static employment" is used to denote AAA defense of those installations which are of a permanent or semipermanent nature. AAA can be employed statically for defense of installations located in the combat zone as well as in the communications zone and zone of interior. Since installations requiring AAA defense in the communication zone and zone of interior normally are of a permanent or semipermanent nature, AAA in those zones is employed statically.

b. A static defense may include AAA protection of the lines of communication and supply, military and naval establishments, manufacturing centers, and other establishments of major importance.

53. NATURE OF DEFENSE. a. Static employment in defense of an objective involves the carefully coordinated employment of guns, searchlights, automatic weapons, barrage balloons, and area smoke screens. All of these weapons may be used together or in part as indicated by the situation and the available matériel.

b. Both AAA and friendly aviation will usually be employed in the defense of important objectives. It must be recognized, however, that not even these combined efforts can guarantee the protection of any defended area. The most practical approach indicates that the defense must be employed with the view of destroying such a large percentage of the attacking aircraft that it would be disastrous for the enemy to continue the attacks.

54. DEFENSE OF LARGE AREAS. In planning the general defense of a large area it must be recognized that the attacking aircraft are not subject to the restrictions which exist in the attack of small separate objectives. A bomb dropped anywhere within the large area, will do

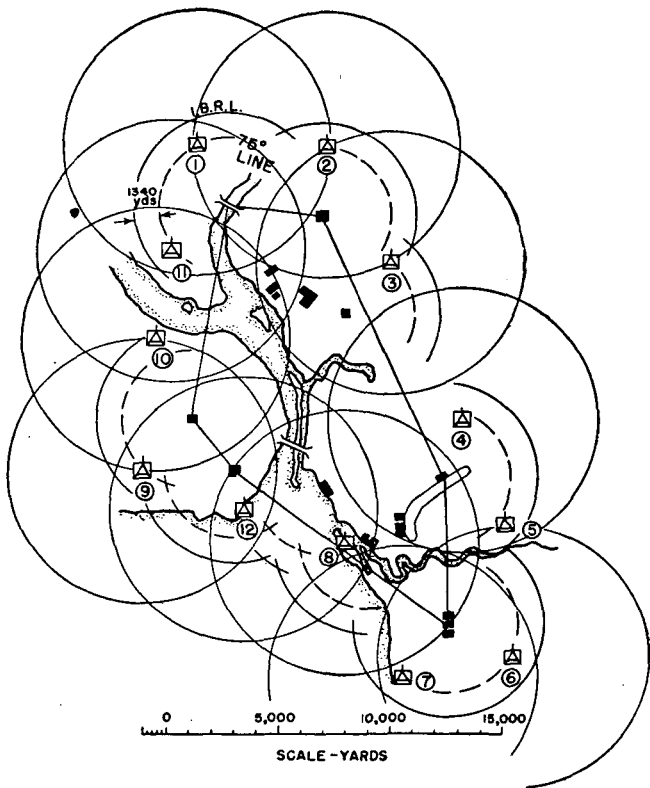

Figure 21. Typical defense of multiple objectives showing the final disposition of the guns. Note the one additional battery and the balanced distribution indicated by the gun circles.

some damage; therefore the period of straight, level flight for careful bomb sighting is unnecessary. Attacking aircraft are free to take evasive action during their run up to the point of bomb release. Also, the orthodox bombing run directed against specific objectives within the area may develop anywhere, without reference to a previously established IBRL or critical zone on the edge of the large area. The aircraft may, however, be expected to fly rectilinear courses until they encounter antiaircraft fire. The problem of defense against such targets then resolves itself into careful preparation of fire to secure maximum effectiveness in the first few salvos, and careful arrangement of armament to secure the maximum possible gun density throughout the area.

55. DISPOSITIONS. The problem resolves itself into providing, over and around the entire area, as great a gun density as matériel and the importance of the area justifies. The following factors are a guide in planning the defense:

a. Gun batteries are located first to provide uniform coverage over the entire defended area. A gun-density of *no less than 16* is desired. This figure may be much higher for important areas.

b. Coverage of approximately the same "gun-density" is extended from the edge of the area to the IBRL.

c. Some batteries must be able to fire upon the attacking aircraft during their last 30 seconds of flight before reaching the IBRL of the defended area.

d. The defense is strengthened along probable routes of approach by disposing batteries so that attacking aircraft are subjected to increasingly greater and more accurate fire as they approach the IBRL.

56. DEFENSE OF MULTIPLE OBJECTIVES. When a number of objectives are located in the same general area, the enemy will normally attempt to bomb the individual objectives rather than the entire area. In defending a "multiple objective" area, two situations must be considered.

a. Defense of each objective separately. If the indi-

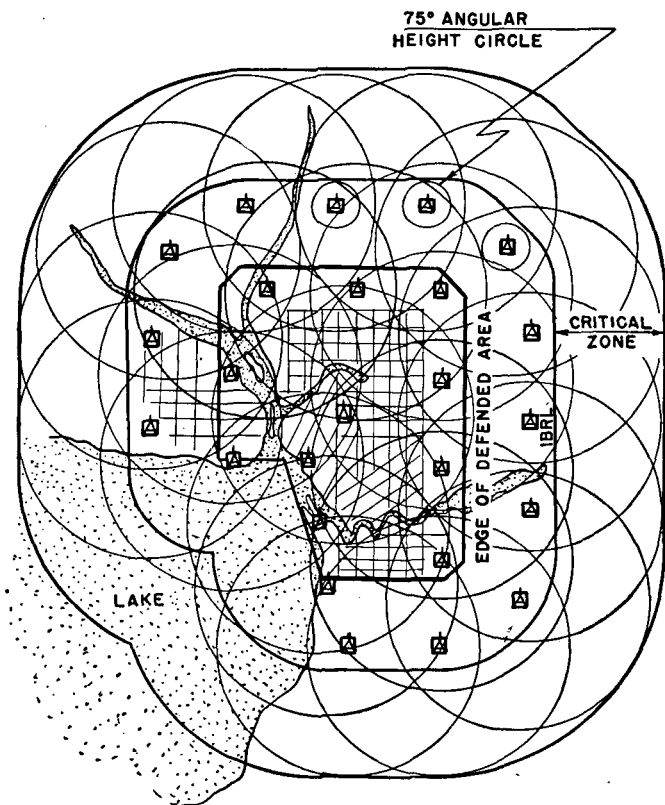

Figure 22. Location of AAA guns in protection of a large area.

vidual objectives within the area are more than 15,000 yards apart, it is best to establish a separate gun defense for each objective warranting defense.

b. **Use of a single coordinated defense.** If the individual objectives are within 15,000 yards of each other, it is best to establish a coordinated gun defense of all the objectives.

57. SEPARATE DEFENSE OF MULTIPLE OBJECTIVES. When multiple objectives are to be defended singly, each objective is treated as if it were a separate small objective. AAA gun batteries are placed inside the FBRL of the objective, at a distance equal to the radius of the dead area for the assumed bombing altitude.

58. COORDINATED DEFENSE OF MULTIPLE OBJECTIVES. When a single coordinated gun defense is employed, the following procedure normally is followed:

a. Draw lines connecting the outer objectives. This is the "area boundary line." (See fig. 20.)

b. Draw the IBRL's and 75° lines for the objectives lying on or near the area boundary line. Consolidate and continue these lines to form a continuous IBRL and 75° line for the entire general area. The 75° line is measured inward from the IBRL in the defense of large objectives. (See fig. 20.)

c. Place gun batteries on the 75° line within mutually supporting distance.

d. Determine the strength of the defense in its various sectors as described in paragraph 49, or by another suitable method.

e. Relocate the batteries so as to give the proper pattern of strength.

f. If the area pattern is so large that batteries on the 75° line cannot fire over all of the area inclosed by the area boundary line, a few batteries must be added within the area to provide coverage of the center of the area. This is necessary to deny unmolested flight by enemy aircraft over this area.

59. STRENGTHENING THE DEFENSE. If, after placing the batteries on the 75° line to obtain the desired defense, there are additional batteries, the defense should be augmented by:

a. Adding more batteries along the most probable routes of enemy approach.

b. A slight strengthening of batteries within the area boundary line.

c. An additional ring of batteries about 3000 to 5000 yards outside the 75° line.

60. AIRDROME DEFENSE. A major factor in the success of all operations is air superiority. In obtaining air superiority, the security of our own aircraft is of equal importance with the destruction of enemy aircraft. The protection of our own aircraft on the ground and the protection of airdrome installations is one of the important missions of AAA. In addition to the general principles discussed in section I of this chapter, the following additional factors should be considered in preparing the AAA gun defense of an airdrome.

a. The airdrome commander indicates the order of priority of AAA defense for installations and units of the airdrome.

b. The airdrome commander should be requested to furnish an aircraft so that an AAA officer may make an air reconnaissance of the field and positions selected.

c. A study of outstanding terrain features surrounding the airdrome and of routes selected in simulated attacks by pilots unfamiliar with the terrain will give an indication of the most probable routes of enemy approach.

d. After the most probable routes of approach have been determined, the defense is built up to make certain that each route has adequate coverage, and that the entire area has an all around defense. Adjacent AAA defenses are also considered in determining the most probable routes of approach.

e. The plan for the AAA protection of the airdrome must be coordinated with the airdrome commander.

f. Defenses must be sited in depth so that attacks on

the perimeter of the airdrome will not eliminate the AAA defenses. Weapons must be sited to bring maximum fire on all air targets, whether attacking simultaneously or in successive waves, before hostile acts are committed.

g. It is particularly important that plans for AAA fire, movements of friendly aircraft in the vicinity of the airdrome, and recognition and identification of aircraft be prepared and executed so that AAA units do not fire on friendly aircraft. In this connection, it is imperative that all pilots be prohibited from performing, in the immediate vicinity of the airdrome, any maneuver, which might be interpreted as a hostile act.

h. The ground defense of the airdrome should be considered when siting AAA gun units in the defense of advanced landing strips (FM 1-26).

61. EMPLOYMENT WITH AREA SMOKE SCREEN. Area smoke screens are often employed in static situations. AAA gun operations probably will not be affected by the screen as they normally will be sited outside the screened area, and because present position data are obtained by radar rather than visual tracking. Fire units not blanketed by smoke engage attacking aircraft by normal methods of fire control. Fire units blanketed by smoke are governed in conduct of fire by SOP and in fire direction by the AAOR.

62. EMPLOYMENT AGAINST JET- OR ROCKET-PROPELLED FLYING BOMBS. a. Flying bombs have made their appearance as weapons. The outstanding characteristics of such present devices are:

- (1) High speed.
- (2) Constant altitude and direction.
- (3) Small vulnerable area.
- (4) Lack of maneuverability.

b. Guns are sited in depth in belts across the known or likely paths of approach, so that fire can be maintained for as long a time as possible. Due consideration must be given to establishing these belts in areas where the bombs

may be dropped with least damage, if not exploded in the air.

c. Low angular height radar coverage and adequate AWS and AAAS are particularly important in the defense against present flying bombs, since such devices fly at relatively low altitudes (2000 to 5000 feet).

Section III. Mobile Employment

63. GENERAL. a. The term "mobile employment" is applied to AAA operations with ground combat forces, such as the army, corps, and division, in mobile situations. The allotment of AAA guns to ground forces will depend upon the ground and air situations, the mission, and the availability of AAA gun units (FM 44-1).

b. The principles governing mobile employment of AAA guns are basically the same as those described in the preceding two sections. Any one of the type defenses may be used. In mobile operations, however, orthodox dispositions are more apt to be affected by conditions of terrain, weather, observation, and road nets, availability of matériel, and the variables that arise from direct contact with enemy ground forces.

c. The discussion in this section is limited to the employment of AAA guns in the primary role against aircraft. It must be understood, however, that in any of the situations noted the force commander may commit a portion or all of his AAA means to a ground role rather than to defense against air attack. The AAA commander must be prepared to undertake and accomplish the missions thus arising. Chapter 7 covers the use of guns in secondary roles.

64. DEFENSE PROBLEM. a. Objectives require protection from enemy bombardment (both high and low altitude) and dive-bombing attacks, and from air observation.

b. The determination of which elements of a force need AAA protection and the priority of defense for these various elements is the responsibility of the force commander.

This decision having been made, the AAA officer then makes recommendations for the disposition of the AAA units available. The AAA officer provides complete protection for the elements in the order of priority stated and as far as the matériel will go. If the shortage of matériel is such as to prevent protection of certain elements, then the force commander should be notified of this fact.

c. The AAA gun defense may include the protection of troop concentrations or bivouacs, artillery areas, troops on the march, troops engaged in offensive, defensive, or retrograde movements, supply and administrative establishments, sensitive points on routes of communication, and other vital elements. Whether this protection is provided on a large area or specific small objective basis depends upon the size of the area to be defended and the relative importance of the objectives within it. If the area is small, or the objectives within it are reasonably close together, the AAA mission may be accomplished by giving over-all coverage to the entire area.

65. CONCENTRATIONS—BIVOUACS. a. General.

(1) Troop movements into and from a concentration or bivouac area must be unimpeded and unobserved, and the troops and installations within the area must also be protected from air attack and observation. This requires that some AAA units be among the first to arrive in the concentration or bivouac area, and among the last to leave. It also requires that particular attention be paid to camouflage discipline and other passive defense measures.

(2) AAA guns provide protection primarily against bombardment and reconnaissance aviation, while automatic weapons are employed to combat dive bombing, minimum altitude, and low level horizontal attacks.

(3) For protection against hostile observation, emphasis is placed on passive defense measures. Since secrecy is a prime consideration, care must be taken not to reveal the location and importance of a concentration or bivouac area by AAA dispositions or premature fire.

b. Priorities for defense. (1) Priorities for defense in a concentration area will include critical points along the

routes to and from the concentration area, detraining and entraining areas, landing areas, and installations and troops. The basic AAA defense should be furnished by the highest echelon possible. For instance, army AAA should form the basis for the AAA gun defense of an army concentration area in order that the defense will not be unduly disturbed when corps AAA units commence moving out with the corps to which they are attached.

(2) Normally, automatic weapons will be the only AAA defense provided for a bivouac area.

66. TROOP MOVEMENTS. a. General. (1) The problem of defending a column or columns is principally one of defending critical localities along the route of march. The advance of the column must be unimpeded, and troops and matériel must arrive at their destination in sufficient strength and condition to accomplish the mission. Security from hostile air observation is also an important requirement.

(1) AAA units responsible for route protection must be in position ready to defend the critical points before the main body of the column arrives. This requires such AAA units to march well forward in the column. The mobility of AAA guns is, in most situations, equal to that of the protected unit of the field force. When time and space factors, road net, and road priorities permit, fire units advance by bounds to their positions along the route of march preceding the main body. The force commander should give the AAA road priority when this is necessary for the accomplishment of its mission.

(3) Protection of critical points should normally be furnished by the highest echelon involved in the movement. For example, in the advance of an army, army AAA should defend critical points along the main routes. This gives continuous defense to the advance, and allows AAA gun units attached to corps to move forward with them.

(4) Since advances are generally made in more than one column, and on a wide front, decentralization of control is advisable. Army AAA units should normally be attached to corps for the advance. This insures the AAA

units a place in the march tables of the corps with which they are moving. When they reach the objective they are to defend, they may again revert to control of the higher echelon.

b. Priorities for defense. Critical points may include bridges, defiles, initial points, entrucking and detrucking areas, bivouac and assembly areas. However, choice of the critical points which AAA guns will defend must be carefully considered. A bridge or crossroad is not necessarily a critical point unless its destruction will actually impede the advance of the column, and an alternate route is not readily available. Straight open stretches of road may be just as favorable for enemy air attack as actual defiles.

67. OFFENSIVE. a. General. (1) During preparation for, and throughout the period of attack, the combat forces are particularly subject to hostile air observation and attack. The enemy will use all the means at his disposal, including his air units, against those elements of our forces which constitute the greatest menace to his security. Therefore, the available AAA guns are disposed so as to provide the maximum protection to those elements which are most vulnerable and whose disorganization might jeopardize the successful accomplishment of the assigned missions.

(2) In an attack to force the crossing of a river line, AAA defense is centered around the crossing fronts and particularly the sites of bridges. Continuous protection for the bridges is maintained as long as required.

b. Employment. (1) In general, the corps AAA guns protect forces engaged in the main effort of the corps, the reserves, and the artillery which follows in close support of the attack, from enemy air attack and observation.

(2) The defense established is an area defense coordinated to the extent necessary by the AAA commander. In attack, the fact that the corps combat elements are concentrated well forward permits the location of the AAA gun batteries well forward. Advanced positions not only afford better protection for troops concentrating for the attack, but also avoid the necessity for an early displacement forward. In all forward positions AAA guns should be de-

filaded from enemy artillery fire and from observation from the enemy front and flanks. Depending on the number of AAA guns available, their role in attack situations may include protection of any or all of the following (not arranged in order of priority):

(a) Assault units, especially those making the main effort.

(b) Reserves and their routes forward, including their probable zone of action.

(c) Artillery areas.

(d) Command posts.

(e) Supply establishments and train bivouacs.

(3) In forward areas, AAA gun positions should be selected with a view to their possible use for antimechanized missions and field artillery reinforcement.

c. Coordination. The initial coordination of corps and army AAA gun units will be provided for in the army attack orders. Forward displacement of corps AAA gun units should be made by bounds. Special consideration is given to the relative importance of protecting combat elements and trains in the forward area, especially at bottlenecks in the road net, as against that of continuing the protection of the elements that would be left unprotected by the forward movement. The army AAA is displaced forward when the importance of renewing the continuity of AAA defense, interrupted by the forward movement of corps AAA units, is greater than that of protecting the installations and elements initially protected. Army AAA units are used to protect army installations. When the corps requires additional AAA, army AAA units are attached to the corps until they are no longer needed or until more urgent demand arises elsewhere.

68. DEFENSIVE. a. General. (1) When a force is on the defensive, effective AAA defense becomes of increasing importance, as the defensive attitude usually presupposes a local inferiority in strength not only of the ground forces but also of the air forces. A hostile attack usually will be supported by powerful concentrations of combat aviation which our own forces may be unable to combat

effectively by offensive action. Under these conditions, the AAA units must be prepared to furnish a larger part of defense against hostile air activity, except that afforded by other units with their organic weapons. To perform this mission, the AAA is disposed to provide the maximum protection to those elements which are most likely to be subjected to air observation and attack and whose disorganization might jeopardize the successful accomplishment of our mission.

(2) The location of the units of the AAA defense is affected by the fact that, in defense, normally there are fewer installations and also a smaller concentration of troops in forward areas than in the case of offensive action. Therefore, a more complete coordination of AAA defense throughout the action is possible.

b. Position defense. Position defense is characterized by organization of a single position on which the resistance is based. The AAA gun units are disposed to furnish a defense of those forces and elements essential to maintenance of the position. The defense must be continuous throughout all stages of a hostile attack and must be arranged so as to facilitate protecting our forces in case of a withdrawal from the position.

c. Employment. (1) The AAA guns are disposed initially to protect the organization and occupation of the battle positions from hostile observation and bombardment. It is necessary to deny the enemy any reconnaissance of the battle positions, since such information would enable the enemy to attack before our positions were established.

(2) After the positions are organized the guns are displaced to provide protection for the following elements (not arranged in order of priority):

(a) Troops occupying forward defensive localities of the main battle position.

(b) Artillery areas.

(c) Reserves and their routes forward, including their probable zone of action.

(d) Important supply establishments.

(e) Command posts.

(3) As in an offensive situation, mechanized attack may

be a serious menace and as such must be considered in planning the AAA defense. Preparations should include the reconnaissance of positions for antimechanized firing in case it becomes necessary to employ the AAA guns as part of the local antimechanized defense. The possible mission of field artillery reinforcement must also be considered in siting guns and in planning the defense.

(4) Forward gun batteries normally are not emplaced forward of the line of the corps medium artillery. They are mutually supporting and coordinated with the AAA guns of adjoining corps.

69. DEFENSE OF RIVER LINE. In the defense of a river line, the principal mission of the AAA guns is to protect the field artillery and the reserves. Preparation must be made for forward displacement to cover possible crossings in attack or counterattack.

70. PURSUIT. The AAA commander must be prepared to provide AAA defense for the direct pressure as in the attack, and to displace his AAA gun units forward as may be necessary. As coordination is difficult during the pursuit, it is often necessary to attach AAA battalions to the various elements continuing the attack. The force making the encircling maneuver also needs AAA protection.

71. RETROGRADE MOVEMENTS. a. **Employment protecting withdrawal.** (1) When not pressed by the enemy, a withdrawal is protected by AAA as in a march. When withdrawing under pressure of hostile ground forces, AAA is employed to insure the protection of the columns against air observation and attacks by combat aviation. The enemy aviation will attack not only columns and formations, but also critical localities on routes to the rear. Preceding such attacks, the enemy will endeavor first to determine evidences of withdrawal, and to observe the formations, columns, and roads, in an effort to determine the direction of movements, position of covering forces, routes of retirement, and sensitive points on such routes. For this reason it is of particular importance that the AAA

remain in positions from which it may deny to the enemy observation of front-line units up to the very last practical moment.

(2) The progress of leading elements must not be obstructed, as this would jeopardize the movements of the main forces following. Protection of critical points is therefore of the utmost importance. The following (not arranged in order of priority) are normally given AAA gun protection:

(a) Critical localities along the route or routes of march.

(b) Assembly areas (where units are formed for the march).

(3) Withdrawal is usually made under cover of darkness; however, the tactical situation may demand a daylight operation. AAA gun protection becomes even more important under the latter condition.

(4) In a withdrawal, enemy mechanized forces are a serious menace and the AAA defense must be planned with this in mind. Care must be taken that guns are not left without protection in positions exposed to mechanized attack. Alternate positions for antimechanized fire are reconnoitered so that the AAA guns may engage ground targets if the mechanized threat requires it.

b. Employment protecting delaying action. In delaying actions the AAA is employed primarily to protect the artillery and critical points from hostile air attack and observation. Since decisive engagements are avoided in delaying action, withdrawals from one defended position to another must be made. During the withdrawals, AAA is employed in the manner described in a above.

c. Control. (1) Coordinated control in the case of AAA gun units is usually practical in a withdrawal and should be maintained. If AAA guns are to be used with a covering force, they are attached thereto. Units so detached revert to the control of the force commander as soon as practical.

(2) Liaison between AAA units and supported units is of paramount importance, and must be continuous, positive, and accurate.

72. AMPHIBIOUS OPERATIONS. a. General. (1) Each phase of an amphibious operation requires adequate AAA protection. AAA gun units normally are attached to the landing force.

(2) See FM 31-5 and 44-1 for more detailed information on amphibious operations.

b. Missions. (1) Primary missions of AAA gun units attached to the landing force may include:

(a) Protection of the regimental combat teams, boat operations in the beach area, and the assault forces as they proceed inland against low level and high altitude bombing attack and reconnaissance aircraft.

(b) Protection of beach installations, airfields, and port facilities against low level and high altitude bombing attack and reconnaissance aircraft.

(2) Secondary missions may include—

(a) Assisting in the antimechanized defense of the beach.

(b) Acting as field artillery.

(c) Assisting the Navy in protecting shore operations against seaborne attack by light naval forces.

c. Preparation. Preparation for amphibious operations is all-important. Preplanning and preselection of radar sites are particularly important for AAA gun units, as there normally will not be time immediately after landing to make the usual clutter and coverage diagrams to determine the adequacy of the selected sites. Communication preparation also is necessary to prevent failure of fire direction and fire control communications during the early critical phases of the operation.

d. Command. Command of AAA gun battalions normally is not decentralized during amphibious operations. Battalions may be attached to regimental combat teams initially. As soon as practicable, such battalions revert to the control of higher AAA echelons, in order that an integrated gun defense of the beach area may be provided as early as possible. The time or circumstance of such detachment and consolidation must be clearly given in the plan.

e. Landing phase. (1) AAA guns are not landed in

the first assault wave, AAA protection being provided initially by AAA automatic weapons and barrage balloons. AAA guns should, however, be ashore and ready for action by nightfall of D-day, since they can finish the only effective AAA defense against enemy air attack by night.

(2) Consideration should be given to landing the battalion headquarters battery radar with the forward echelons of gun batteries to facilitate early establishment of adequate radar surveillance.

(3) It is essential that gun units are landed with equipment, necessary ammunition, and personnel in the same landing craft. Only essential equipment and personnel are taken ashore initially.

f. Shore operations. (1) Initial establishment and integration of the AAA gun defense proceeds as for normal operations.

(2) Gun units intended for beach defense should not be extended inland with assault elements or otherwise dissipated by assault unit commanders, except upon approval of the landing force commander. As soon as practicable, or whenever prescribed by higher authority, gun units intended for continued beach defense will be released from the assault division and attached to higher AAA command echelons landed to take over the AAA defense of the beach. This release must be coordinated carefully with the landing of additional gun units to accompany the assault forces inland.

(3) Gun units accompanying the assault forces inland are employed in their normal roles.

(4) Gun units landed during the consolidation phase are used in normal land roles in the AAA defense of the beachhead with particular emphasis on airfields, ports, major supply points ashore, and concentrations of reinforcements.

g. Air-AAA coordination. Air-AAA coordination is particularly critical during the initial landings and establishment of the beachhead. Initially, AAOR operations are conducted from the air control center afloat. Normal AAOR and AAAS functions must be established on the beach as early as possible. (See FM 44-1 and 44-8 for further information.)

CHAPTER 7

EMPLOYMENT AGAINST GROUND AND NAVAL TARGETS

Section I. General

73. **GENERAL.** a. The characteristics and capabilities of AAA guns make them effective weapons against mechanized, terrestrial, and water-borne targets.

b. Unless the engagement of such targets is assigned as a first priority mission by the force commander, AAA guns are sited for their normal primary mission of defense against air attack. However, when sites equally suitable for both primary and secondary missions can be found, they are selected; otherwise alternate positions are reconnoitered and, if time permits, prepared.

c. When ground or naval targets are to be the first priority mission, the appropriate division or higher commander gives definite orders to this effect. Employment of AAA guns will then be in accordance with the established doctrine of the arms ordinarily used to accomplish such missions. AAA cannot be expected to perform more than one primary mission at a time.

d. See paragraph 21.

74. **LIMITATIONS OF AAA GUNS.** a. AAA guns have certain tactical and technical limitations which must be given the consideration when AAA guns are to be employed against ground targets.

(1) The mobility of AAA guns is dependent upon and limited by the capabilities of their prime movers (par. 10).

(2) 90-mm AA guns cannot be emplaced and ready to fire in the same time required for other weapons of similar caliber. While the 90-mm gun on mount M2 may fire direct fire from the wheels, more accurate fire results when the gun is emplaced.

(3) AAA guns are high-velocity weapons. Their flat trajectory and fire control generally deny the use of defilade, except hull defilade.

(4) Their high silhouette, lack of protective armor, and general vulnerability dictate their use from dug-in, concealed positions in most cases.

(5) Normal methods of AA technique, fire control and fire direction cannot be used against ground targets.

b. The above limitations are less important when considering the employment of AAA guns against naval targets, as such targets are normally engaged as a secondary mission from previously occupied AA positions, or in static defenses when sufficient time is available for thorough preparation of the defense.

75. SUPPLY, MEDICAL SERVICE, AND EVACUATION. When AAA gun units are employed in a ground role, and are employed as a unit, supply, medical service, and evacuation will be accomplished in the normal manner (ch. 10). In instances where AAA gun battalions are broken down and separate missions assigned to batteries, supply, medical service, and evacuation functions will be performed by the unit to which attached unless otherwise provided. Ammunition expenditure in a ground role will be much greater than in the normal AA role. When possible, normal ammunition loads for AA use are kept intact. Organic gun battalion vehicles transport ammunition for the ground role, provided the plan can be foreseen sufficiently in advance to permit such action. When this is not the case, the appropriate higher commander must allot sufficient trucks from other sources.

Section II. Engagement of Mechanized Targets

76. MECHANIZED TARGETS. a. All types of mechanized vehicles, from the heavy tank to the unarmored truck, are suitable targets for AAA guns.

b. **Vulnerability of tanks.** The most vulnerable points are the vision slits, ports, sides, belly, tracks, and track suspension mechanisms. Flanking fire is preferable to frontal because more of these vulnerable points are brought under fire.

c. **Recognition of targets.** The personnel of AAA bat-

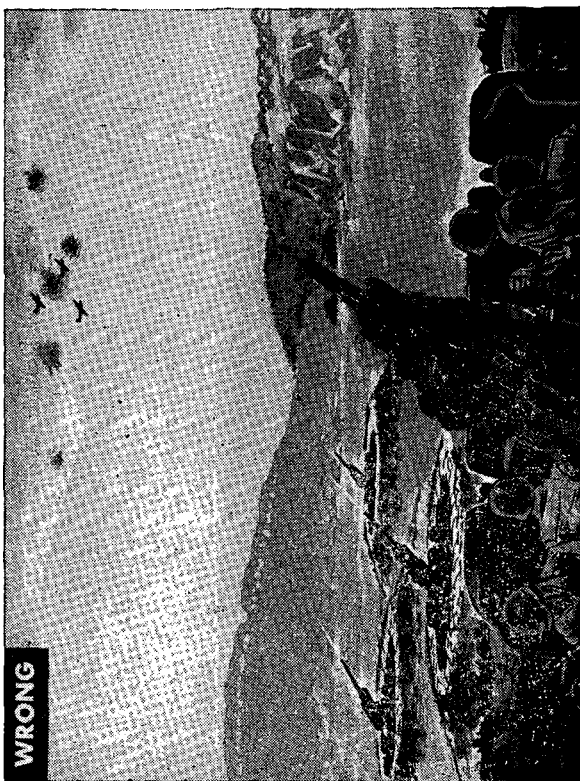

Figure 23. Wrong—all guns are firing at aircraft.



Figure 24. Right—one gun is firing at tank, others are firing at aircraft.

teries must be trained to distinguish between hostile and friendly armored vehicles. FM 30-40 will serve as a guide for this training. FM 21-7 lists Film Strips and Training Films on recognition of armored vehicles.

77. FIRE CONTROL DOCTRINE. a. The fire unit is the single gun. Control of fire is decentralized to the fire unit commander.

b. In general, as many targets as possible, within range, are engaged by the fire unit. The fire of more than one gun on one target is ordered only when no other suitable target presents itself for the other guns.

c. The crews of moving tanks are relatively deaf and blind except in a narrow sector to their front. These handicaps are exploited by the use of ambush wherever possible. For example, three tanks which appear to be traveling a course that will take them to the flank of a gun position are permitted to come almost abreast of the position and the *last* tank in column engaged first, then the second in column, and last, the leading tank. The essential feature of this action is that the tanks are not threatening the fire unit position.

d. When tanks are threatening to overrun a gun position, the tank which is most menacing (usually the closest to the gun) is fired upon until hit, then the next nearest (or most menacing) is fired upon.

e. **Accuracy of fire.** To stop a tank, it must be hit with a force sufficient to penetrate the armor, demolish a vital part of the mechanism, or incapacitate the crew. It is essential that initial fire be accurate. To obtain greater initial accuracy, *AAA guns must withhold fire until mechanized targets are within 1,000 yards range.*

f. **Speed of opening fire.** Mechanized attacks may come quickly and with little warning, and must be engaged speedily.

Section III. Employment as Antitank Artillery

78. GENERAL. a. The appropriate division or higher commander must decide in each case when AAA gun units

will be diverted from their AA role and employed as anti-tank artillery. To permit necessary supply and control, units no smaller than a battery are so employed. Whenever possible, AAA gun battalions should be employed as units under the battalion commander.

b. The commander of the unit to which the AAA gun units are attached gives the general missions and designates what units the AAA guns will reinforce or support.

c. AAA guns are suitable against all normal antitank or tank destroyer targets.

d. Concealment of positions, surprise, and accuracy of initial fire are primary considerations. Concealed routes to positions should be utilized. If possible, positions should be dug-in and occupied under cover of darkness.

e. A ground reconnaissance is the responsibility of AAA battalion and battery commanders prior to entry into combat. It must be carefully planned, coordinated with other antitank or tank destroyer units in the area, and continued with emphasis on—

(1) The selection of initial and alternate positions which will permit the accomplishment of the assigned mission and will take full advantage of cover and concealment.

(2) The selection of routes to the positions.

(3) Location of targets or areas in which targets are likely to appear, such as avenues of approach for tanks.

(4) Locations of elements of supported or reinforced units and of nearby friendly troops and installations.

(5) The location of CP's, communication routes, and initial and subsequent ammunition supply points.

79. EMPLOYMENT. a. **General.** AAA gun units are employed to deepen the antitank defense established by organic division weapons and tank destroyer units.

b. **Limitations.** The relative immobility of AAA guns and the time required for emplacement, digging-in, and camouflage limit the use of AAA guns as tank destroyers. AAA guns are not capable of rapid movement from positions in readiness to firing positions and to successive positions in readiness. Thus AAA guns can be most effectively

used in an antitank role when sufficient time is available for thorough preparation and organization of firing positions and routes thereto.

c. Advantages. The high armor-piercing ability and rate of fire of AAA guns make them particularly effective against heavily armored vehicles. Whenever possible, AAA guns should be sited to control avenues of approach into which such vehicles can be canalized by other weapons in the antitank defense, including tank destroyer units.

d. Reconnaissance. Full advantage should be taken of the information obtained by the reconnaissance elements of tank destroyer and other units.

80. MISSIONS. **a.** Missions which may be encountered by AAA gun units employed as antitank artillery in the attack include:

(1) Aiding in the protection of a flank open to hostile armored attack.

(2) Defense of rear area installations.

(3) Support of the main effort against hostile armored counterattack.

b. Missions which may be encountered by AAA gun units employed as antitank artillery in the defense include:

(1) Strengthening existing antitank defenses.

(2) Aiding in the protection of a flank open to hostile armored attack.

(3) Protecting rear area installations.

(4) Retention in mobile reserve to support a counter-attack.

81. SELECTION AND OCCUPATION OF POSITIONS. **a. Disposition.** In general, guns must be disposed in such a manner that they are mutually supporting. Not only should their fields of fire overlap but each gun should be able to assist adjacent positions in the event of a direct attack upon that position.

b. Selection of position. (1) In general, good antitank positions are found behind and well below the crests of hills where guns are concealed from enemy tanks or artillery and can suddenly engage tanks coming over the crest

of the hill as well as those which may come around the hill. A field of fire of at least 1,000 yards should be available.

(2) In level terrain, guns are emplaced in depressions in the ground or dug-in to reduce the silhouette of the piece. On such terrain a field of fire several hundred yards greater than the maximum ranges at which fire will be opened is desirable so that targets can be tracked for a few seconds before fire is begun.

(3) Flanking fire is preferable to frontal fire.

(4) The inability of AAA guns to shoot and run to new positions indicates that concealment is of high priority in the selection of positions. Concealed routes to the position will materially reduce the chances of enemy observation of the occupation of positions, and nearby concealment and cover is sought for prime movers and other necessary vehicles.

c. Occupation of position. Positions must be occupied with the greatest possible speed and concealment. To prevent hostile observation, movement into positions under cover of darkness is made wherever possible. Prime movers must be returned to nearby concealed positions immediately after towing in the guns.

d. Organization of position. Where natural concealment permits, small parties may begin organization of the position prior to the time that the guns are actually emplaced. In any event, immediately upon occupation, the position must be field fortified as rapidly as time and material permit. Concealment is improved by the use of camouflage where necessary. Disposition of the elements providing local security is made. As time permits, the position can be improved by the erection of barriers and by emplacement of antitank mines if available.

e. Position sketch. A rough sketch of the position and the field of fire covering probable avenues of attack is made. Ranges to prominent or critical points are obtained by the most accurate means available and recorded on the sketch. Critical ranges are memorized by the gun commander and the gun pointers.

f. Alternate positions. Although it is not expected that

AAA guns will move during the actual fire fight, alternate positions are selected and prepared for movement thereto when time permits. When there is reason to believe that the location of a position has been revealed to the enemy, movement to an alternate position is made as soon as practicable.

g. Mobility. (1) AAA guns possess a limited tactical mobility. The time required to go from traveling to firing position is about 15 minutes.

(2) Because of the length of time required to move AAA guns, they are not used in the first line of the anti-tank defense, but rather are disposed in depth to cover possible break-throughs in the front line. Normally, no attempt is made to move AAA guns just prior to or during an engagement.

h. Local security. Full advantage is taken of the protection afforded by obstacles, both natural and artificial, and by the location of friendly troops. Local defense of the gun position is provided by the caliber .50 machine guns and small arms. It is important that positions be prepared to detect and defend themselves against attack by small dismounted parties.

i. Warning system. In addition to guards for local security of the position, each unit must arrange to obtain an early warning of the approach of hostile mechanized vehicles. In a stabilized situation, a tie-in with the general warning system may be sufficient. Under other circumstances, the battery or platoon posts lookouts in commanding positions to observe the probable routes of enemy approach. The gun battalion AAAIS radio net may be used as an antitank warning net.

82. REFERENCES. Portions of FM 7-35, 18-5, 18-20, and 18-21 are applicable to the employment of AAA guns as antitank artillery.

Section IV. Assault of Fortifications

83. GENERAL. a. The accuracy and flexibility of AAA guns make them effective weapons in assault upon and destruction of permanent or organized fortifications or

strong points. Present-day technique for the assault of permanent fortified positions requires the employment of a selected, mixed force which may include AAA guns. A careful reconnaissance of the works to be attacked and a period of preparation during which the troops rehearse their parts in the contemplated attack are required. The actual assault is preceded by a bombardment during which the fortifications are shelled by long range artillery and bombed by aircraft. During this phase, the flat trajectory, high muzzle velocity antitank and AAA weapons are moved into positions from which fire can be placed directly on the ports and embrasures of the fortification. After the long range artillery ceases its fire, the AAA and antitank guns continue their fire until the assault parties can actually cover the structure with flame throwers and smoke. Having closed with the emplacement, special parties destroy it with demolition charges and grenades.

b. In addition, AAA guns may be called upon to reduce smaller pill boxes or to fire upon armored turrets.

84. TECHNIQUE. In the assault of permanent fortifications, the mission of the AAA guns is to require the defenders to keep ports closed and to deny their use for returning fire. 90-mm guns firing HE shell can effectively accomplish this mission. Where actual destruction is required, direct fire with AP shot or APC projectiles will be required.

85. TACTICS. Since fire is by direct laying, the prime tactical consideration is a clear view of the target at a range sufficiently short to permit observation and adjustment of fire on small openings in the fortifications. On the other hand, in order to hit these targets, guns often must be emplaced within the field of fire of the defending weapons. Concealment, movement into position under cover of darkness, and adequate provisions for protection of the gun crews are necessary. In general, the same rules can be applied here as were discussed in paragraph 81. (See FM 31-50 for detailed information on assault of fortifications.)

Section V. Employment as Field Artillery

86. GENERAL. a. The appropriate division or higher commander must decide in each case when AAA gun units will be diverted from their AA role and employed as field artillery. To permit the necessary supply and control, units no smaller than a battery are so employed. Whenever possible, AAA gun battalions should be employed as units under the battalion commander.

b. The commander of the unit to which the AAA gun units are attached gives the general missions: direct support, general support, and/or reinforcing.

c. AAA guns are suitable against all light and medium field artillery targets, except those defiladed due to the flat trajectory of the AAA guns.

d. Concealment of positions, surprise, and accuracy of initial fire are primary considerations. Concealed routes to positions should be utilized. If possible, positions should be dug-in and occupied under cover of darkness.

87. EMPLOYMENT. a. **General.** AAA gun units normally are employed as corps artillery. The field artillery assigns the fire missions. The AAA gun unit conducts the fire.

b. **Coordination.** Close liaison, coordination, and communication with the field artillery is required. Certain duties relative to coordination are performed by the field artillery and others by the AAA gun units:

(1) The exact fire missions and the general position areas for the AAA gun units are determined in conference by the field artillery unit commander and the AAA gun unit commander.

(2) The field artillery executes the *target area* and *connection* surveys.

(3) The AAA executes the *position area* survey.

(4) The AAA gun battalion establishes a fire direction center. The field artillery designates targets and prescribes the number of rounds and time of firing. Under certain conditions, it may be necessary for AAA gun batteries to

be controlled directly by the field artillery fire direction center.

(5) The AAA establishes liaison with the field artillery. The field artillery establishes liaison with the supported unit.

(6) The reconnaissance, selection, and occupation of positions within the general position areas designated are the responsibility of the AAA.

c. **Missions.** AAA guns are capable of all types of field artillery missions. Their long range and high rate of fire make them particularly useful in long range neutralization, destruction, harassing, or interdiction fire. The range of time fire, using standard time fuzes, is limited by the maximum fuze range (30 sec.).

88. RECONNAISSANCE AND SELECTION OF POSITIONS. a. A ground reconnaissance is the responsibility of AAA battalion and battery commanders. It must be carefully planned, coordinated with the field artillery, and continued with emphasis on—

(1) The selection of initial and alternate positions which will permit the accomplishment of the assigned mission and will take full advantage of cover and concealment.

(2) The selection of routes to the positions.

(3) Location of targets or areas in which targets are likely to appear.

(4) Locations of elements of the field artillery and of other nearby friendly troops and installations.

(5) The location of CP's, FDC's, communication routes, and initial and subsequent ammunition supply points.

b. Reconnaissance by the AAA battalion commander follows the general principles outlined in chapter 8. The location of batteries, however, is not the same since the AAA battalion area in the field artillery role is approximately 500 to 1,000 yards in diameter. 360° field of fire is not essential. The AAA fire direction center is located at the AAA gun battalion command post.

c. The battery reconnaissance, selection, and occupation of positions generally follow the same pattern as is prescribed for an AAA position. The guns, in the case of a

field artillery role, however, are placed in line and staggered as natural protection, defilade, and camouflage dictate. The battery front is limited to distances such that voice control can be exercised by the battery executive. Machine guns are located on the flanks and rear of the position for local protection. Vehicles are dispersed to the rear or flanks of the position. Range section equipment, except communication equipment, firing tables, charts, slide rules, etc., normally is not taken with the battery on this type of mission, but is left in an assembly area well to the rear. In some instances, the battery radar may be employed for the location of round targets. Such routine operations as providing personnel shelter, field fortifications, and camouflage are subordinated to immediate delivery of fire. The various steps in the organization of the position are taken during lulls in the firing. Close-in defense of the position is provided.

89. REFERENCES. For further information on the use of AAA as field artillery see FM 44-1, 44-10, and 44-21. For a detailed study of the field artillery problem, see FM 6-20, 6-40, 6-100, and 6-101 and the pertinent film strips and training films.

Section VI. Employment as Seacoast Artillery

90. MISSION. The secondary mission of AAA guns disposed on or near water areas in which enemy units may operate is fire for the destruction of hostile naval craft.

91. TARGETS. Naval craft which may be effectively engaged by AAA guns include motor torpedo boats, landing craft, destroyers, transports, submarines, and various types of auxiliary naval craft. Highest priority is given to fire against motor torpedo boats.

92. EMPLOYMENT. a. At ranges under 3000 yards, 90-mm guns can be fired by direct fire methods using the antimechanized sights. However, director controlled fire should be used whenever possible.

b. AAA guns employed against naval craft are emplaced at as low heights of site as is practicable. In this manner, maximum advantage will be taken of the flat trajectory at the shorter ranges.

c. The characteristics of the 120-mm gun make it possible to engage targets at greater ranges, and also make it more effective against larger naval vessels (par. 91) than the 90-mm gun.

d. See FM 4-5 for a complete discussion of the tactical employment of seacoast artillery.

93. CONTROL. If AAA guns to be employed in the antinaval role are located in harbor defenses where seacoast artillery guns are used for the same mission, their employment should be coordinated under a single commander.

94. AMMUNITION. HE ammunition with point detonating impact type fuzes (set to *delay*) are normally used for antinaval fire, except that against motor torpedo boats the fuzes should be set to *superquick*. Time fire and air burst ricochet fire have only limited application in antinaval fire. (See FM 44-10 and 44-21.)

CHAPTER 8

RECONNAISSANCE, SELECTION, AND OCCUPATION OF AA POSITIONS

Section I. General

95. TYPES OF UNITS. This chapter covers the reconnaissance selection, and occupation of AA positions by mobile AAA gun units. In general, the procedure in making reconnaissance and in selecting and occupying positions by semimobile AAA gun units is similar to that of corresponding mobile units. With appropriate modifications, the instructions contained herein apply to either unit. For reconnaissance, selection, and occupation of positions for ground fire, see chapter 7, FM 6-101, FM 7-35, and 18-5.

96. DUTIES OF COMMANDERS. AAA commanders, whenever possible, precede their commands to the position to be occupied. The senior AAA commander keeps in close touch with the force commander and his staff, and keeps informed regarding the tactical situation and plan of action. He makes whatever reconnaissance is necessary to enable him to prepare the plan for the AAA defense.

97. PLANNING DEFENSE. AAA establishes an area defense whenever practicable. The general distribution of AAA elements must be made as a result of a thorough map and ground reconnaissance. In static employment, when time is available, it is probable that the entire defense will be planned by the senior AAA commander and his staff.

98. GROUND RECONNAISSANCE. a. The purpose of ground reconnaissance is to verify the suitability of routes both into and out of positions selected as a result of the map reconnaissance, to determine alternate routes and positions in conformity with the tentative plans, and in some cases to determine the suitability of one or more positions before preparing a plan of defense. The exact

location of gun batteries must be selected by an actual reconnaissance of the ground. In a rapidly moving situation in the combat zone, there may be little or no time available for an actual ground reconnaissance by battalions or groups.

b. Map reconnaissance must be depended upon to such higher degree as opportunity for ground reconnaissance is lessened. Each commander must anticipate possible forward displacement. Subordinate commanders must carry on continuous progressive reconnaissance and study of terrain.

c. Reconnaissance of all commanders must include the consideration of future likely developments, such as location of new bridges, critical points on possible routes, and possible location of important installations.

99. INSTRUCTIONS TO UNITS DURING RECONNAISSANCE. When a commander goes forward on reconnaissance, he instructs the officer left in command (normally the executive) on the following points:

- a. The tactical situation.
- b. Probable route of reconnaissance party.
- c. Troop movements desired, if any.
- d. Time and place further orders will be issued.

100. TIME AVAILABLE FOR RECONNAISSANCE. Although the time available for reconnaissance varies with different situations, AAA guns must be able to go into position promptly, and their employment must not be delayed by undue reconnaissance. Reconnaissance must be as thorough as time permits, but must be completed in time to permit the batteries to march to their positions without halting. Whenever possible, commanders must allow sufficient time to subordinates so that their reconnaissance can be completed during daylight hours.

Section II. Reconnaissance by Higher Echelons

101. BRIGADE AND GROUP. Reconnaissance made by an AAA brigade or group commander is general in nature and consists chiefly of a map reconnaissance based pri-

marily on the character, location, and plans of action of the forces or elements to be protected. (See FM 44-1.)

Section III. Battalion Reconnaissance

102. PURPOSE. a. The purpose of the battalion commander's reconnaissance is to enable him to verify the suitability of positions chosen from the map for the batteries of his battalion. He will verify the suitability of the following, selected tentatively by map reconnaissance:

(1) Positions of battalion command post and observation posts.

(2) Site for battalion headquarters battery radar.

(3) Site for battalion AAOR if one is to be established.

(4) Position of service elements of headquarters battery.

(5) Some, or all, of the routes to positions.

(6) Each gun battery position selected, if time is available.

b. In any case, the battalion commander visits each position at the earliest opportunity. In making his reconnaissance, the battalion commander satisfies himself that the general locations are the best obtainable under the circumstances.

103. ANTICIPATION OF FUTURE MOVEMENTS.

When the situation indicates the probable character of displacement to be made, the battalion commander makes, or causes to be made, such reconnaissances as are necessary to permit the prompt issue of orders when movements to new positions are required.

104. METHODS. Battalion commanders employ such of their staff and such personnel from the organizations of their units as they may desire for assistance in their reconnaissance. Personnel accompanying the battalion commander on his reconnaissance are called the battalion commander's party. Reconnaissance is made by one of the methods given below. In each case the reconnaissance is preceded by a map study to select tentative positions.

a. The battalion commander, assisted by his staff, makes the entire reconnaissance.

b. Each battery, platoon, or unit commander reconnoiters a particular area for his own positions. This method is employed when the time is very short.

c. The battalion commander, accompanied by the battery commanders, visits all sites.

105. PROCEDURE WHEN TIME IS AVAILABLE.

The following procedure of the battalion commander in making a reconnaissance when considerable time is available is outlined as one method. It must be varied as the situation demands. He does the following things:

a. Makes a map reconnaissance to select locations for all elements.

b. Makes decision as to when movement of troops is to begin. This decision is based on orders from higher commander, mission, time, and availability of routes.

c. Makes decision as to how the ground reconnaissance is to be made and determines the party to accompany him.

d. Gives or sends orders to the battalion executive and to battery commanders covering—

(1) Enemy and friendly situations.

(2) Troop movements desired, if any.

(3) Time when, and place where further orders will be issued.

e. Makes reconnaissance.

f. Returns to point where officers have been directed to assemble and issues his order for occupation of the positions.

106. **BATTALION COMMAND POST.** The battalion command post is located to insure rapid and reliable communication with the batteries of the battalion, and with the group.

107. **REAR ECHELON.** a. When indicated by the necessity of the situation, a rear echelon is established.

b. **Bivouacs of supply section.** When required by the situation, the supply section of the headquarters battery is bivouacked in the vicinity of the railhead supplying the

unit or with that portion of the headquarters battery located in the rear echelon.

108. BIVOUAC OF AMMUNITION SECTION. The battalion ammunition section is bivouacked under cover from air observation, out of hostile light artillery range, conveniently located for the supply of ammunition, and on the best available road net leading to the batteries and ammunition supply points.

109. OBSERVATION POSTS. The observation posts are located so that they can function continuously as intelligence posts.

Section IV. Gun Battery Reconnaissance and Occupation of Positions

110. BATTERY COMMANDER'S RECONNAISSANCE. a. Purpose. The purpose of the battery commander's reconnaissance is to determine—

(1) Route, if it has not been prescribed, to the new position.

(2) Position of each gun.

(3) Positions of fire control instruments and radar.

(4) Positions of machine guns and air guards.

(5) Location of battery command post, bivouac area, maintenance section, and trucks.

(6) Procedure in occupying the position.

(7) Alternate positions.

(8) Dummy positions.

b. Methods. (1) *Time and character.* (a) When the battery is not in position and ample time is available, the battalion commander may direct the battery commander to accompany him on his reconnaissance. When the battalion commander has designated the position of the battery, the battery commander determines the details of the occupation and makes arrangements for having the battery guided to the position.

(b) When reconnaissance has been made by the battalion commander and the route and position selected by

him, the battery commander precedes the battery to determine the details of occupation.

(c) When the battalion commander orders the occupation of a position selected from the map without a reconnaissance of the ground, the battery commander must determine the exact location of the position as well as the details of its occupation. He selects a position as close as possible to the point designated by the battalion commander. Positions which take advantage of natural concealment are preferable to those which require artificial camouflage. When a suitable position within several hundred yards is not available, the battery commander must consider the mission of the battalion and the locations designated for other batteries and select a position which will best conform to the battalion commander's plan, reporting this change to the battalion commander without delay.

(2) *Battery commander's party.* The battery commander's party is normally small, particularly if the battery remains in position during the reconnaissance. Under some conditions it consists only of an agent or messenger and a chauffeur. Under other conditions the range officer, communication sergeant, and other battery personnel accompany the battery commander.

c. Procedure. (1) The battery commander proceeds to the locality designated by the battalion commander for the battery position, noting the condition and capacity of the bridges, and selecting alternative routes when necessary. He causes route markers to be posted or sends messengers to guide the battery as may be necessary. In selecting positions he is guided by the doctrines given in paragraph 113.

(2) Before leaving on a reconnaissance, the battery commander informs the executive of the orders of the battalion commander directing the reconnaissance or the change of position. If he is to return before the battery changes position, the battery commander informs the executive of the probable time of his return. If the battery is to withdraw from position while he is on a reconnaissance, the battery commander instructs the executive as to the

time of withdrawal from position and the route, and gives such special instructions concerning the conduct of the march as may be applicable.

(3) The battery commander's order is issued in fragmentary form.

111. CLEARANCES. The battery commander assures himself of the necessary road and position clearances. Road nets may be so crowded that the traffic control of higher headquarters assigns priorities on the road. Likewise, areas of operation may become so congested that the higher headquarters of the area of operation may require that authority for occupation of particular sites be obtained.

112. BATTERY COMMAND POST. Battery command posts are seldom selected by the battalion commander but are selected by the battery commanders, who report the positions to battalion headquarters. The command post is located near the firing battery at a point which facilitates command, and the establishment, operation, and maintenance of battery signal communication. Normal battery signal communication is discussed in chapter 5.

113. CONSIDERATIONS AFFECTING SELECTION OF GUN POSITION. a. **General.** Selection of positions for gun batteries involves first a choice of the locality within which the individual battery is to be located. This is determined by map study as a part of the general plan for the defense of the objective. The exact position for the battery is selected after a careful ground reconnaissance of the designated locality has been made. Seldom, if ever, will an ideal position be available in the field. On the contrary, the choice of position will, in most cases, be a compromise of the considerations listed below. The ideal gun battery position provides—

(1) Conditions of terrain which meet the technical requirements of radar units. This consideration is of primary importance. The effectiveness of radar demands that it be sited in the best possible operating locality.

(2) A clear field of fire for the guns through 360°,

and down to the minimum elevation at which the guns are capable of firing against both air and ground targets.

(3) A clear field of view for the instruments of the range section, including the radar unit.

(4) Ground which is fairly level and firm.

(5) Concealment for all elements of the battery, and ease of camouflage.

(6) Terrain which facilitates local defense of the battery against mechanized attack.

(7) A good road net to front, flanks, and rear.

(8) Opportunity for establishment of communications.

(9) Alternate positions nearby.

b. Fields of fire and observation. All around field of fire and unobstructed field of view are primary considerations in locating the gun battery. To sacrifice these requirements materially may seriously interfere with the accomplishment of the assigned mission. Any decision to sacrifice a part of the field of fire and unobstructed view is made only after a careful consideration of all of the factors involved.

c. Slope and nature of ground. The emplacement of AAA guns is difficult on steep slopes. The ground selected should be fairly level and firm. Consideration must be given to drainage.

d. Security against attacks by ground forces. AAA guns are so emplaced that they will require a minimum of special protection against attacks by ground forces. *Where it can be done without interfering with the normal air defense, guns will be sited so that they may be employed against ground attack when such attack presents a direct threat to the battery.* In case of raids or similar forms of attack, the batteries must be provided with a means for their own local protection. (For employment of AAA guns in a ground role, see ch. 7.)

e. Secondary roles. When the secondary roles of field artillery, antitank artillery, or seacoast artillery are likely to become important, the choice of position will be influenced by that consideration.

f. Roads. It is highly desirable to place guns in the vicinity of good roads with routes available to the front,

flanks, and rear. This is especially important in areas where it may be necessary to make a sudden change of position.

g. Communication. See chapter 5.

h. Alternate positions. Alternate positions should always be selected and prepared, as completely as time permits.

114. OCCUPATION OF POSITION. **a. General.** As the battery approaches position, at some previously designated time and point, the executive, range officer, assistant executive and the first sergeant, and such other personnel as are required, report to the battery commander, who issues orders for the occupation of the position.

b. Guns. (1) The executive indicates to each gun commander the position of his gun and such details as to the route as may be necessary.

(2) Each gun commander conducts his gun to its position and directs its preparation for action.

(3) Guns are located to take advantage of dispersion and available cover and concealment. Visible indications of symmetry in the battery set-up must be avoided.

c. Ammunition. The ammunition for immediate use should be dumped in the immediate vicinity of each gun. Ammunition should be segregated by lot numbers in order to assure more uniform muzzle velocities. When possible all ammunition for each battery should be of the same lot number. The amount of ammunition varies in accordance with the requirements of the situation and must be indicated in the SOP of higher headquarters. The executive directs the movement of ammunition vehicles to the gun positions or unloading point when the route is clear.

d. Fire control instruments. The range officer conducts the range section to its unloading point, and directs the unloading and setting up of instruments and equipment by the several details. He directs the preparation for action as described in appropriate Field Manuals.

e. Machine guns. The organic AA machine guns assigned to each gun battery are employed to provide close-in defense of the battery against low flying combat aircraft. It is generally preferable to site the machine guns indi-

vidually in a square about the gun position to include the range section. Machine guns are sited about 100 yards from the perimeter of the position. Whenever possible, they are located on elevations high enough to clear the installations from the field of fire. Terrain may indicate that machine guns be sited in pairs, or all four together, in commanding positions that provide an all around unobstructed view and field of fire. These weapons will protect the initial stages of the occupation from their positions in the vehicles. They are emplaced one at a time. The machine guns cal. .50 M2, HB on mount M32, are normally sited for the protection of the maintenance section, motor park, and other installations. The M63 machine gun mount allows the conversion of the cal. .50 M2, HB for use on the ground. If the terrain or the tactical situation dictates, these weapons are added to the defense of the gun position area. All machine guns may be used for protection against hostile ground forces and are sited with this in view. The assistant executive directs the occupation of position by the machine gun detail.

f. Bivouac area, maintenance section, and motor park. The bivouac area, maintenance section, and motor park are located in protected places, convenient to the road net, and at such distance from the battery position that their discovery will not reveal the gun location. The first sergeant is in immediate charge of the maintenance section, truck park, and bivouac.

SECURITY AND PROTECTION

Section I. Concealment

115. GENERAL. The term "concealment" is used to indicate the means taken, by utilizing natural concealment or erecting camouflage, to prevent hostile discovery of installations or personnel. Concealment in the case of AAA is sought from hostile observation from high points within the enemy lines (terrestrial), or from hostile air observation, photography, and attack. In addition, positions are made inconspicuous from possible ground approaches. (FM 5-20.)

116. FACTORS. a. In general, effective concealment depends on the following factors in the priority indicated:

- (1) Proper choice of position.
- (2) Camouflage discipline.
- (3) Proper erection of camouflage materials.
- (4) Suitability of camouflage materials.

b. Deception may be accomplished either by concealment of the installation or by making it appear a natural part of its surroundings.

117. CONCEALMENT FROM OBSERVATION. Concealment from hostile observation may be accomplished by—

- a. Camouflage and camouflage discipline.
- b. Flash defilade.
- c. Night movements.
- d. Use of dummy and alternate positions. (See FM 44-1.)

118. DETAILS OF CAMOUFLAGE. For details of materials and erection of camouflage, see FM 5-20 and 5-20F.

119. SUPERVISION. a. The maintenance of deception and concealment is continuous and requires constant su-

pervision and instruction to the ultimate development of sound indoctrination.

b. The use of actual observation from the air is the most accurate method of judging the effectiveness of concealment.

120. DISCIPLINE. Next to the proper choice of position, camouflage discipline is the most important factor in the effective value of camouflage. Camouflage discipline involves confining movements to designated routes, closing nets when not firing, repairing or changing covering material when necessary, keeping men under concealment when enemy aircraft are overhead, not allowing smoke to appear near the position, keeping ammunition covered, not allowing trucks or other vehicles to stop in daylight or the road near the position, and not permitting transportation to turn around near the position. Confining movements of personnel to designated routes, thereby preventing the forming of new paths which are easily spotted on air photographs, is the requirement most difficult to enforce. Under the fatigue and strain of active conditions, effective camouflage discipline can be maintained only with the most thoroughly trained personnel. The plan for enforcement of camouflage discipline must include the roping or wiring in of open paths or trails and camouflaging them where necessary, and the requiring of all personnel to remain under concealment so far as practicable.

Section II. Cover

121. GENERAL. Cover is the means employed for the physical protection of personnel and matériel. Protection for AAA positions is required against fragments and the blast effect of bombs and shells. Dependence for protection must be placed on dispersion and concealment, fox holes, and parapets. Well constructed emplacements form dependable protection against any projectile except a direct hit within the emplacement. Fox holes or trenches are dug for protection of personnel at or near the other elements of the battery position. No individual fox holes or trenches

are provided for gun crews at the emplacements. For the weapon's themselves, protection is provided by dispersion and concealment. Excavation and parapets will provide additional lateral protection from blast and fragmentation.

122. DETAILS OF DESIGN AND CONSTRUCTION.

For details of design and construction of fortifications, see FM 5-15 and FS 4-202.

123. COMMAND POSTS. Because of the wide dispersion of AAA units, group and battalion command posts can generally be located under natural cover and concealment. The gun battery command post, however, is more restricted as to location and may require artificial cover. For all command posts, location may be restricted by communication requirements.

124. AMMUNITION. Pits, properly dispersed, are dug for ammunition storage. Provision is made for the drainage of ammunition pits.

125. DISPERSION. Dispersion is an effective means of minimizing the effects of bombardment attack or artillery shelling. The massing of vehicles and personnel is avoided. On the march, a column having no more than 10 or 12 vehicles per mile affords an unprofitable target for bombardment (see FM 25-10). In bivouac or in occupying a position, the maximum use is made of dispersion consistent with the accomplishment of the mission and consideration of other defense measures.

Section III. Local Security

126. GENERAL. Security, as applied to AAA, is the all around protection of a command by the adoption of effective measures to prevent surprise and interference by the enemy and to minimize the effect of an attack from the land or from the air. The necessity for security is basic in every action in war from the time of the first possible encounter to the final battle and must be uppermost in the

minds of the commanders of all echelons. Every commander is responsible at all times for the security of his command.

127. PHASES. a. **When beyond striking distance of hostile main forces.** AAA units not in the vicinity of hostile main forces are not subject to an attack by infantry supported by other arms. Such units are, however, subject to air attacks, to attacks by motorized or mechanized forces, and to attacks by airborne troops.

b. **When within striking distance of hostile main forces.** When AAA units are located in forward areas or in the vicinity of the hostile main forces, they may be subject, in addition to the attacks mentioned above, to attacks by infantry supported by field artillery and other arms.

128. MEANS OF ATTAINING SECURITY. a. **Information.** In either phase, timely, accurate, complete, and continuous information as to the location, strength, composition, and capabilities of the enemy is the most effective means of attaining security against surprise.

b. **Liaison.** In all situations close liaison with adjacent supported units is maintained.

c. **Organization of ground.** Security against attack and infiltration by foot troops, cavalry, or mechanized units, and the protection of the command from gun fire or air attack is increased by such organization of the ground as the situation permits. This organization includes the construction or improvement of obstacles, planting of antitank mines, clearing of fields of fire, preparation of defensive positions to include the siting of AAA weapons for ground fire, and the construction of splinter-, bomb-, and gas-proof shelters. (See FM 7-10.)

d. **Other means.** Other means of security, when not in concealed positions, include dispersion of troops, and matériel when halted and rapidity of movement and extended intervals between vehicles when on the road. The final active means of security is the readiness for employment, in position or on the march, of all available AAA weapons.

129. ACTIVE LOCAL DEFENSE AGAINST AIR ATTACK. An AAA gun battery, in accomplishing its primary mission, provides incidental protection for its own elements against air attack.

a. **Gun batteries.** The guns and fire control instruments of gun batteries must be emplaced in positions exposed to air attack in order to obtain a satisfactory field of fire. Moreover, while such elements may be concealed initially, their positions are disclosed when the guns open fire. Heavy bombardment aircraft may be accompanied by low-flying light bombardment aircraft directed against the AAA gun batteries. The defense against such attacks is furnished by machine guns assigned to the batteries for this purpose.

b. **Small-arms fire.** When not actively engaged in manning AA equipment, and when firing has not been prohibited, all individuals fire their small arms at hostile low-flying aircraft upon command of responsible noncommissioned officers.

130. PASSIVE LOCAL DEFENSE AGAINST AIR ATTACK. As far as is consistent with the accomplishment of the AAA mission, the troops employ passive means of defense against air attack and observation in addition to appropriate active means.

b. On receiving a warning of an approaching air attack, troops in position and not actively engaged in manning AAA equipment, or in bivouacs or billets, seek the nearest concealment or cover and remain motionless.

c. *Troops must be prepared to accept casualties rather than to permit air attacks to be effective. Troops engaged in manning AAA guns must remain at their posts and continue to perform their duties, relying on such cover as has been provided for their protection.* When the situation is such as to indicate the necessity for continued movement and a command is subjected to frequent air attacks, maximum advantage is taken of dispersion and available concealment and cover without unduly delaying the movement.

131. DEFENSE AGAINST CHEMICAL ATTACK. Details of defense against chemical attack are given in FM 21-40.

CHAPTER 10

SUPPLY AND EVACUATION

Section I. Supply

132. GENERAL. This section covers the supply of AAA gun units. Officers detailed to perform supply functions should refer to FM 100-10 and 101-10 for definitions and basic supply procedure.

133. SUPPLY AGENCIES. a. Gun battalions have the personnel and transportation required to draw and deliver all classes of supplies. The brigade and group do not carry any supplies for the battalions but do coordinate the supply activities of subordinate units with higher supply agencies. The supply section of the brigade and group headquarters batteries draw and deliver supplies for the brigade and group headquarters batteries only.

b. Requisitions for all supplies which are procured by requisitions originate in the batteries. The battalion supply officer consolidates these requisitions and forwards them through the appropriate supply channels. A copy of the consolidated requisition is submitted to the group or other higher echelon supply officer for information and follow-up purposes.

c. When requisitioned supplies become available, the requisitioning unit is notified. The battalion supply sections then draw and distribute the supplies.

134. CLASS I SUPPLIES (RATION). The forward flow of rations is normally automatic, based on daily battalion, group or brigade consolidated reports of actual strength. A daily train carrying the needed supplies from depots in the communications zone is sent forward for division, corps and army troops. Upon arrival at the rail-head, the rations are picked up by the battalion supply sections.

135. CLASS II SUPPLIES (SUPPLIES AND EQUIPMENT PRESCRIBED BY TABLES OF EQUIPMENT). These supplies are requisitioned, drawn, and distributed as described in paragraph 132.

136. CLASS III SUPPLIES (GASOLINE AND OIL). The army quartermaster establishes gasoline and oil supply points at all railheads and depots or at convenient locations, such as civilian gasoline filling stations, on the main supply routes. Each vehicle sent to an army supply point replenishes its supply at a convenient gasoline supply point at or en route to the army supply point. Vehicles remaining in the forward areas are resupplied by exchanging empty containers for full ones brought forward from gasoline and oil supply points by unit transportation.

137. CLASS IV SUPPLIES (ARTICLES OF MISCELLANEOUS NATURE). Supplies such as construction material are normally requested through special requisitions. The receipt and delivery of such supplies are the same as for class II supplies.

138. CLASS V SUPPLIES (AMMUNITION). a. Battalions draw ammunition against credits established by higher headquarters as a result of periodic expenditure reports submitted by the battalion munitions officer based on reports from the batteries. The expenditure report is transmitted to the group or other higher echelon munitions officer who forwards it to the proper requisitioning or procuring authority. The unit reports are made by telephone, if possible, and later confirmed by written reports. Extra ammunition normally is ordered forward by higher authority whenever an increased supply appears necessary.

b. The battalion ammunition section is employed to draw and distribute ammunition from the supply point to gun battery positions. However, when ammunition expenditure is rapid or the distance to the supply point great the battalion ammunition section vehicles may be used to bring ammunition to intermediate supply points, from which the battery vehicles supply the batteries.

139. VARIATIONS TO SUPPLY CAUSED BY TACTICAL EMPLOYMENT. a. When the AAA unit is operating as part of a division, corps, or army, the foregoing methods of supply are normally applicable.

b. When the AAA unit is operating in a fixed or harbor defense or in the immediate vicinity of either, quartermaster supplies are obtained from the local quartermaster. Medical, ordnance, or other supplies are likewise obtained through corresponding local supply officers to the extent available or obtainable; otherwise, by special requisition or call on higher supply echelons.

c. When operating in the communications zone or zone of the interior and at a considerable distance from an army post, camp, or station, the battalion, group, brigade and other unit may receive its supplies direct from a depot.

Section II. Evacuation

140. MEDICAL PERSONNEL ATTACHED TO AAA. There is no medical detachment with the headquarters and headquarters battery of groups or brigades. However, each battalion has a medical detachment. For command purposes, administration, and supply, the battalion medical detachment is an integral part of the battalion.

141. ORGANIZATION DURING COMBAT. a. For combat the battalion medical detachment is broken down into a battalion aid station detail and battery aid details for attachment to each battery. The battalion aid station detail supervises the medical service of the battalion. It is organized to provide an administrative supply and evacuation service for the battery aid details, for establishment and maintenance of battalion aid stations and dispensaries, for care and treatment of troops located in the vicinity of battalion headquarters, and for direction and supervision of the dental service of the battalion.

b. A battery aid man is attached to each battery to provide emergency medical aid.

142. **FUNCTIONING DURING COMBAT.** a. In general the tactics employed by combatant units determine the medical service plans to be employed by attached medical units. Medical detachments in the field have as their objective the rendering of support and assistance to combat troops.

b. In the field, the battalion aid station is established at or near the AAA battalion headquarters. From this position, the surgeon maintains contact with battalion headquarters and with each battery aid detail, supervising, reinforcing, and to a limited degree, supplying these latter units with medical supplies and materials.

c. Aid stations must not be established near ammunition supply points nor in proximity to the designated parking places for artillery vehicles. They may be established near roadways, but never at important points such as road intersections and crossroads. A road in the immediate vicinity of an aid station is desirable to insure evacuation by ambulance.

d. During periods of activity the battery aid men live with the batteries to which attached, and return to their sections only at such times as the battalion is brought together for rest or training. When a battery remains in one position for a considerable period of time, battery aid men obtain a small stock of medical supplies with which to establish local aid posts near the battery positions. Battery aid men care for the casualties occurring in the battery and take post in the vicinity of the guns when the battery is firing or receiving hostile fire. Casualties are given medical aid, promptly removed to a place of safety, and prepared for evacuation. Evacuation from the battalion is as directed by higher headquarters. In stabilized or partially stabilized situations, the battery aid men are required to report at least once daily to the battalion aid station for the purpose of giving information and receiving instructions.

APPENDIX I

TABULAR DATA ON BRL'S AND CRITICAL ZONES

Altitude (yards)	Bomb sight time	Speed 100 yards per second			125 yards per second			150 yards per second			175 yards per second			200 yards per second		
		IBRL ¹ from objec- tive	Criti- cal zone	Dis- tance of outer limit of critical zone from objec- tive	IBRL from objec- tive	Critical zone	Dis- tance of outer limit of critical zone from objec- tive	IBRL from objec- tive	Critical zone	Dis- tance of outer limit of critical zone from objec- tive	IBRL from objec- tive	Critical zone	Dis- tance of outer limit of critical zone from objec- tive	IBRL from objec- tive	Critical zone	Dis- tance of outer limit of critical zone from objec- tive
1,000.....	20	1,360	2,000	3,360	1,700	2,500	4,200	2,040	3,000	5,040	2,380	3,500	5,880	2,720	4,000	6,720
2,000.....	20	1,930	2,000	3,830	2,413	2,800	4,913	2,895	3,000	5,895	3,378	3,500	6,878	3,860	4,000	7,860
3,000.....	20	2,370	2,000	4,370	2,963	2,500	5,463	3,555	3,000	6,555	4,148	3,500	7,648	4,740	4,000	8,740
4,000.....	20	2,730	2,000	4,730	3,413	2,500	5,913	4,095	3,000	7,095	4,778	3,500	8,278	5,460	4,000	9,460
5,000.....	30	3,050	3,000	6,050	3,813	3,750	7,563	4,575	4,500	9,075	5,338	5,250	10,588	6,100	6,000	12,100
6,000.....	30	3,340	3,000	6,340	4,175	3,750	7,925	5,010	4,500	9,510	5,855	5,250	11,105	6,680	6,000	12,680
7,000.....	40	3,610	4,000	7,610	4,513	5,000	9,513	5,415	6,000	11,415	6,318	7,000	13,318	7,220	8,000	15,220
8,000.....	50	3,860	5,000	8,860	4,825	6,250	11,075	5,790	7,500	13,290	6,755	8,750	15,505	7,720	10,000	17,720
9,000.....	70	4,090	7,000	11,090	5,113	8,750	13,863	6,135	10,500	16,635	7,158	12,250	19,408	8,180	14,000	22,180
10,000.....	90	4,320	9,000	13,320	5,400	11,250	16,650	6,480	13,500	19,980	7,560	17,750	25,310	8,940	18,000	26,640
11,000.....	90	4,530	9,000	13,530	5,663	11,250	16,913	6,795	13,500	20,295	7,928	17,750	25,678	9,060	18,000	27,060
12,000.....	90	4,730	9,000	13,730	5,913	11,250	17,163	7,095	13,500	20,595	8,278	17,750	26,028	9,460	18,000	27,460

¹ The time of fall of the bomb can be obtained by dividing by 100 the figures in the column IBRL from objective at a speed of 100 yards per second.
 Note.—An approximate conversion of miles per hour to yards per second is made by dividing miles per hour by 2. For example, 400 miles per hour equals 200 yards per second.

APPENDIX II

ESTIMATES, PLANS, AND ORDERS

Section I. Estimates and Plans

1. FORM USED BY AAA COMMANDER. For a form for an AAA commander's estimate of the situation and plan see FM 44-1 and 101-5.

Section II. Field Orders

2. GENERAL. For general information on orders and annexes, as well as for the technique of preparation of a field order, see FM 101-5. Strategic estimates and plans for the use of AAA are prepared in coordination with the proper air force commander before field orders are issued (FM 44-1). Ordinarily, AAA commanders issue either oral or dictated orders which may later be confirmed by written orders. In the paragraphs below are given check lists which may be used as reminders in the preparation of AAA field orders for units assigned or attached to the field forces. It is not to be inferred that all items listed must be included nor that other items are unnecessary. However, those items which are included are expressed in the proper sequence. A trained commander or staff officer prepares an order to fit the situation, not a form.

3. STANDING OPERATING PROCEDURE. In every unit, standing operating procedure is prescribed by the commander whenever possible. This procedure covers those features of operations which lend themselves to a definite or standardized procedure without loss of effectiveness. The adoption of such procedures saves time in the preparation and issuance of orders, minimizes the chances of confusion and errors when under the stress of combat, and greatly simplifies and expedites the execution of operations in the field. (See FM 44-1.)

4. INSTRUCTIONS FOR AAA IN ARMY (OR CORPS) FIELD ORDER. Instructions for the AAA in

an army (or corps) field order are normally given in paragraph 3, under the heading "Antiaircraft artillery units." These instructions include the missions of the army (or corps) AAA, directing particular attention, if necessary, to those bodies of troops, installations, or critical points considered of vital importance. Instructions are also included governing all attachments of AAA to the several corps (or divisions in case of a corps order); directing the protection of such army troops or establishments as may be located in the several corps areas; and insuring coordination between the army and corps AAA, among the AAA of the several corps, and with AAA of adjoining forces.

Note. The instructions for AAA operating with air forces follow in substance those given in this paragraph.

5. BRIGADE CHECK LIST. See FM 44-1.

6. GROUP CHECK LIST. See FM 44-1.

7. GUN BATTALION CHECK LIST.

"1. Information—

"a. Enemy situation—information of hostile aerial activity to include types of airplanes, character and method of attack, locations of airdromes, landing fields, and probable routes of approach.

"b. Plan of action of supported unit, including zones of action, sectors, or bivouac areas, and missions of subordinate units; locations of troops and establishments requiring protection; plans of friendly aviation as they affect the employment of the organic fire units; location of adjacent AAA and air force units, if known; group plan of action and mission of adjacent AAA battalions.

"2. Decision of the battalion commander—to provide protection for certain units, areas, or establishments.

"3. Position, route, mission, normal and contingent sectors, detachment of units or reversion to battalion control of detached units.

"x. Instructions applicable to more than one battery—
time when ready to go into action; withholding

action; instructions as to control; camouflage; instructions to accomplish coordination with aircraft, with balloon barrages, and with adjacent AAA units; secrecy; restriction of movement; priority of targets, priority on roads.

"4. Location of service elements if it can be prescribed at the time and instructions relative to rations; location of and instructions for ammunition train when applicable; location of aid station, or instructions covering evacuation.

"5. Plan of signal communication.

Special instructions relating to the AAAIS.

Axes of signal communication for the battalion, when applicable.

Command posts of the battalion and each battery, when applicable."

8. BATTERY CHECK LIST.

"1a. Enemy situation—special information regarding enemy aerial tactics.

"b. Battalion commander's plan, plan of action of supported unit, including zones of action, sectors, or bivouac areas, and missions of supported units; location of troops and establishments requiring protection; plans of friendly aviation as they affect employment of the battery; location of balloon barrages; location of adjacent and/or other AAA units.

"2. Decision of the battery commander based on his mission.

"3. Position for the battery, and instructions for its internal protection.

Instructions on special employment of particular matériel; for example, radars.

Routes to positions.

"x. Special instructions as to fire control—sectors of fire; method of occupying position; secrecy; camouflage; cover; restriction of movement; local defense; when to be ready to go into action; priority of targets; withholding action; priority on roads; alternate position.

- "4. Ammunition and other supplies; aid station, or instructions covering evacuation.
Location of trucks not required at positions.
Location of maintenance section.
- "5. Plan of signal communication, including at least one alternate.
Location of spotting stations.
Special instructions relating to the AAAIS.
Command post or posts (platoon)."

9. MARCH ORDERS. All march orders follow the prescribed form of the five-paragraph field order. If the convoy is large or if the march is to require several days, the march order may be accompanied by a march table. (See FM 101-5.) In a small unit such as a battalion, especially when part of a larger command, the battalion commander's order may be quite brief and may be issued orally. Check list for march orders is as follows:

- "1. Enemy and own situation.
- "2. Order of march.
Time of departure.
Initial point.
Exact route to be followed (use map or overlays).
Statement as to maximum allowable speed.
Destination of unit or daily run.
- "3. Instructions for various organizations of the convoy.
Instructions applicable to all organizations are included in the last subparagraph lettered 'x'.
- "4. Administrative details, such as supply and messing.
- "5. Information and instructions as to means and maintenance of communication between units of the convoy.
Time of closing old command post and of opening the new one, and positions en route."

10. WARNING ORDERS. A warning order precedes the march order. It is issued as soon as information of a move is received. The proper use of warning orders will allow subordinates time to prepare for a contemplated move and will avoid keeping them alerted over an extended period.

INDEX

	Paragraph	Page
AAOR and AAAIS	23	16
Airdrome defense	60	60
Ammunition	16, 75	13, 73
Dumping	114	94
Amphibious operations	72	70
Antiaircraft fire:		
Doctrines	24	18
In primary role	17	14
In secondary role	18	14
Rate	28	20
Types	27	20
Antimechanized:		
Mission	18	14
Tactics	78-82	76-80
Targets	76	73
Assault of fortifications:		
General	83	80
Tactics	85	81
Battalion:		
Check list	App. II	107
Commander	4	2
Command post	102, 106	88, 89
Organization	3	1
Reconnaissance	102	88
Battery:		
Check list	App. II	108
Commander	2	1
Commander's reconnaissance	110	90
Command post	112	72
Organization	2	1
Bomb release line	38, 44, 45	29, 39, 45
Brigade check list	App. II	107
Camouflage	117	96
Discipline	120	97
Means	118	96
Supervision	119	97
Characteristics of antiaircraft fire	9	4
Characteristics of matériel	10-15	4-13
Check list:		
Battalion	App. II	107
Battery	App. II	108
Brigade	App. II	107
Group	App. II	107
Clearances	111	90

	Paragraph	Page
Command post:		
Battalion	102, 106	88, 89
Battery	112	92
Commander:		
Battalion	4	2
Battery	2	1
Group	5	2
Communication:		
Discipline	30	21
General	29	21
Radio	31, 32	21
Wire	33, 34	23, 25
Concealment	115	96
From observation	117	96
Concentration—bivouac, defense of ...	65	63
Considerations affecting selection of gun position.....	113	92
Cover	121	97
Critical zone	39	31
Defense:		
Adjustment of	50	51
Analysis of	49	50
Density	48	50
Establishing	41	33
Local	126	98
Planning	97	86
Defense against—		
Mechanized targets.....	76-77, 78-82	73-76, 76-80
Naval targets	90-94	84, 85
Defense of—		
Airdrome	60	60
Force in pursuit	70	68
Force on defensive	68	66
Ground forces	63	62
Large area	54	55
Multiple objectives	56	57
River line	69	68
Small objective	44	39
Withdrawal	71	68
Defensive	68	66
Determination of gun positions	44	39
Dispersion	125	98
Doctrines:		
AA defense of ground forces	63, 64	62
AA fire control	24	18
Establishing defense	41	33
Evacuation.....	75, 140-142	73, 103-104

	Paragraph	Page
Field artillery, employment as.....	86-89	82, 83
Field orders	App. II	107
Fire, conduct of	22	16
Fire control	22	16
Fire control system	13	11
Fire direction	22, 23	16
Fire unit	1	1
First burst line	40	32
Fortifications, assault of	83-85	89, 81
Group:		
Check list	App. II	107
Commander	5	2
Organization	5	2
Reconnaissance	101	87
Gun density	48	50
Gun position:		
Camouflage	118	96
Occupation	114	94
Selection	113	92
Limiting range	11	5
Local security	126	98
Machine guns	15, 114	13, 94
March orders	App. II	109
Mechanized targets	76	73
Missions	17	14
Mobile employment	63	62
Mobility	10	4
Naval targets	90	84
Normal and contingent sectors	47	49
Objective, size	36	27
Occupation of positions	114	94
Offensive	67	65
Orders:		
Field	App. II	107
March	App. II	109
Warning.....	App. II	109
Organization:		
Battalion.....	3	1
Battery.....	2	1
Group.....	5	2
Orientation and synchronization, time required.....	10	4
Position, occupation	114	94
Primary role	17	14
Pursuit	70	68

	Paragraph	Page
Radars:		
Characteristics.....	12	9
Consideration of in selecting gun positions.....	113	92
Employment for surveillance.....	51	52
Radio communication.....	31, 32	21
Ranges.....	9	4
Rapid determination of gun positions .	45	45
Rate of fire.....	28	20
Reconnaissance:		
Methods.....	104	88
Procedure.....	105	89
Purpose of.....	98	86
Time for.....	100	87
Reconnaissance by—		
Battalion commander.....	102	88
Battery commander.....	110	90
Brigade commander.....	101	87
Group commander.....	101	87
Retrograde movement.....	71	68
Robot jet- or rocket-propelled flying bombs, employment against.....	62	61
Role:		
Primary.....	17	14
Secondary.....	18	14
Size of objective.....	36	27
Smoke screens.....	61	61
Staff officers.....	7	3
Standing operating procedure.....	App. II	106
Static employment.....	52	55
Supply.....	75, 132-139	73, 101-103
Tactical employment, basis.....	37	28
Target priorities.....	25	19
Telephone communication.....	33, 34	23-25
Time required for—		
Emplacement of matériel.....	10	4
Orientation and synchronization ..	10	4
Troop movements.....	66	64
Types of fire.....	27	20
Volume of fire.....	14	11
Warning orders.....	App. II	109
Wire communication.....	33, 34	23-25