

MHI  
Copy 3

FM 22-5

WAR DEPARTMENT

BASIC FIELD MANUAL



INFANTRY DRILL  
REGULATIONS

August 4, 1941

*2/20/41*

U. S. Army Military History Institute

## BASIC FIELD MANUAL

## INFANTRY DRILL REGULATIONS

CHANGES } WAR DEPARTMENT,  
 No. 3 } WASHINGTON 25, D. C., 16 September 1943.

FM 22-5, 4 August 1941, is changed as follows:

## ■ 1. SCOPE.

\* \* \* \* \*

b. Basic strengths of units are governed by appropriate Tables of Organization. The diagrams of organizations shown in the figures herein are based specifically on approved Tables of Organization. They must be adapted to the actual strength of the units concerned. They may be adapted to any type of unit; to changes in Tables of Organization; and to the drill space available.

[A. G. 300.7 (8 Sep 43).] (C 3, 16 Sep 43.)

## ■ 3. DEFINITIONS.

\* \* \* \* \*

t. *Piece*.—The rifle, carbine, or the automatic rifle.

\* \* \* \* \*

[A. G. 300.7 (8 Sep 43).] (C 3, 16 Sep 43.)

■ 29. FACE IN MARCHING.—The facings in marching are an important part of movements such as COLUMN RIGHT, CLOSE, TAKE INTERVAL, EXTEND, etc. For individual or group instruction in facing to the right (left) in marching, the commands: 1. By the Right (Left) Flank, 2. MARCH, may be used.

a. To face to the right or left in marching and advance from a halt, at the command of execution of the movement, turn to the right or left on the ball of the right foot and at the same time step off in the new direction with the left foot with a half step, full step, or in double time, as the case may be.

\* \* \* \* \*

c. (1) To face to the rear in marching, being in march at quick time, the commands are: 1. TO THE REAR, 2. MARCH. At the command \* \* \* the left foot.

(2) (Added.) To face to the rear in marching being in march at double time, the commands are: 1. TO THE REAR, 2. MARCH.

\*This change printed as a pamphlet to conserve paper and printing and to expedite delivery to the field. This change supersedes C 2, 14 August 1942.

## BASIC FIELD MANUAL

At the command MARCH, given as the right foot strikes the ground, advance two steps in the original direction, turn to the right about while taking four steps in place, keeping the cadence, and step off.

[A. G. 300.7 (8 Sep 43).] (C 3, 16 Sep 43.)

### ■ 34. RULES GOVERNING CARRYING RIFLE.

\* \* \* \* \*

b. (1) The U. S. rifle, \* \* \* the trigger guard. At all other times it is carried unlocked, with the trigger pulled, to prevent damage from long continued compression of the hammer spring.

(2) Whenever troops equipped with the U. S. rifle, caliber .30, M1, are formed under arms, pieces are immediately inspected at the commands: 1. INSPECTION, 2. ARMS. A similar inspection is made before dismissal. If cartridges are found in the chamber or receiver, they are removed and placed in the belt.

\* \* \* \* \*

i. (Added.) Being at Sling Arms, not in ranks, the individual soldier renders the hand salute.

[A. G. 300.7 (8 Sep 43).] (C 3, 16 Sep 43.)

### ■ 44. BEING AT INSPECTION ARMS.

\* \* \* \* \*

b. (Superseded.) *U. S. Rifle, caliber .30, M1*.—1. ORDER (RIGHT SHOULDER, POET), 2. ARMS. At the preparatory command, place the rear edge of the right hand against the operating rod handle with the fingers extended and joined, forcing the operating rod handle slightly to the rear, and at the same time depress the follower with the right thumb; as the bolt rides forward over the follower, remove the thumb from the follower and release the operating rod handle, pull the trigger, and resume POET ARMS. At the command ARMS, complete the movement ordered.

[A. G. 300.7 (8 Sep 43).] (C 3, 16 Sep 43.)

### ■ 59. GENERAL RULES.

\* \* \* \* \*

d. Rescinded.

[A. G. 300.7 (8 Sep 43).] (C 3, 16 Sep 43.)

### ■ 60. LOAD.—a.

\* \* \* \* \*

(2) *U. S. rifle, caliber .30, M1*.—At the command \* \* \* an angle of 45°. With the right hand, he pulls the operating rod

## INFANTRY DRILL REGULATIONS

handle smartly to the rear until the operating rod catch engages the hooks (in front of the square shoulder) on the operating rod. With his right hand he takes a fully loaded clip and places it on top of the follower. He closes his right hand into a fist with the thumb extended. He raises the elbow high and, with the ball of the thumb on top of the clip at its front end (about the middle of the top cartridge) and thumb point to the front, presses the clip down into the receiver until it engages the clip latch. He swings his thumb to the right so as to clear the bolt in its forward movement. With the heel of the right hand he strikes sharply the operating rod handle to insure that the bolt is completely closed. He then carries his hand to the small of the stock. Automatic riflemen do not execute the ceremonial loadings and firings.

(3) (Added.) *To load partially filled clip, U. S. rifle, caliber .30, M1.—(a) Using one hand.*—Being in any firing position, to load a partially filled clip, hold rifle with the left hand at the firing position, with butt resting on a secure surface (the groin, thigh, or ground). Move operating rod handle to its rearmost position with right hand. Receiver remains open. Drop empty clip into receiver and place first cartridge into clip on the follower with the right hand. Press second cartridge into clip, exerting downward rotary motion toward the center of clip with right thumb until cartridge snaps into place. Similarly, continue to load remaining cartridges, each time having the palm of right hand against receiver and rear edge of hand in front of, but not in contact with, the operating rod handle (to prevent bolt from going forward and injuring right thumb during loading). The number of rounds which can thus be loaded (maximum of eight) depends upon the dexterity of the rifleman. After placing last cartridge in clip, loading is completed by pressing down on top cartridge with right thumb and forcing the operating rod handle slightly to the rear with the side of the hand. Remove the thumb from the receiver and release the operating rod handle. The operating rod must be allowed to go forward by the force of its expanding spring. It must not be retarded in its forward movement by contact with the hand. If the operating rod is not promptly released, the bolt may not lock and, when this occurs and the trigger is pressed, the rifle will not fire.

(b) *Using both hands.*—Insert partially loaded clip into receiver on follower with right hand by gripping the sides of clip

## BASIC FIELD MANUAL

with the thumb and middle finger and using the forefinger to hold cartridges against lower lips of clip. Regrasp rifle with left hand at its firing position. Force clip down with right hand until top cartridges are against the upper lips of clip. Then, with right thumb on top cartridge, palm against receiver, rear edge of right hand pressing operating rod handle slightly to the rear, close bolt as indicated in (a) above.

NOTE.—In either case, care should be taken to insure that the base of each cartridge is *against* the rear wall of the clip.

\* \* \* \* \*

[A. G. 300.7 (8 Sep 43).] (C 3, 16 Sep 43.)

■ 82¼. (As added by C 1.) CARRYING POSITION (SLING ARMS).

\* \* \* \* \*

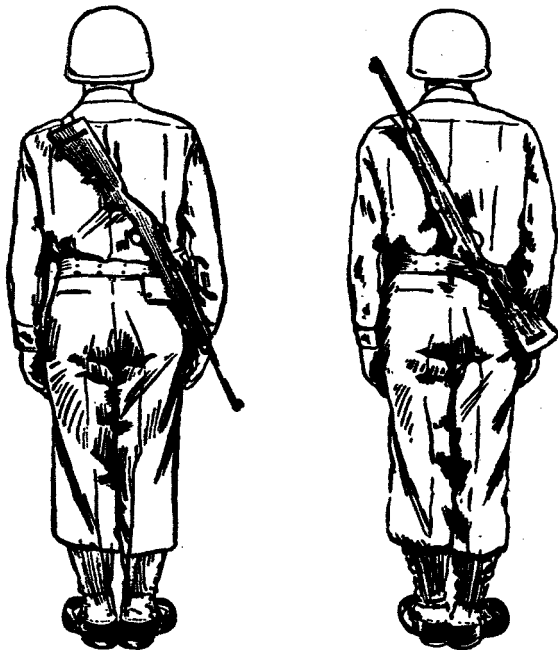

FIGURE 16¼.—Carbine slung on back.

[A. G. 300.7 (8 Sep 43).] (C 3, 16 Sep 43.)

## INFANTRY DRILL REGULATIONS

b. For dismounted marches or field exercises, the carbine will be carried in the manner prescribed by the unit leader. Depending on whether the unit is to move on foot or by truck, or personnel are to be employed in serving a weapon, he may choose any of the following methods:

(1) (Added.) Slung over either the right or left shoulder, with muzzle up.

(2) (Added.) Slung across the back, muzzle *down*, with sling over the right or left shoulder.

(3) (Added.) Slung across the back, muzzle *up*, with sling over the right or left shoulder.

(4) (Added.) Carried in the holster.

[A. G. 300.7 (8 Sep 43).] (C 3, 16 Sep 43.)

### ■ 114. GENERAL.

\* \* \* \* \*

b. As far as practicable, the squad is kept intact. The normal formation of the squad is a single rank or single file as shown in figures 25 and 26. This permits variation in the number of men composing the squad.

\* \* \* \* \*

[A. G. 300.7 (8 Sep 43).] (C 3, 16 Sep 43.)

■ 117. DISMISS SQUAD.—The commands are: 1. INSPECTION, 2. ARMS, 3. PORT, 4. ARMS, 5. DISMISSED.

[A. G. 300.7 (8 Sep 43).] (C 3, 16 Sep 43.)

### ■ 123. MARCH TO OBLIQUE.

\* \* \* \* \*

c. (1) The command HALT \* \* \* the right foot.

(2) (Added.) To stop temporarily the execution of the movement, when marching, for the correction of errors, the commands are: 1. IN PLACE, 2. HALT. All halt and stand fast. To resume the movement the commands are: 1. RESUME, 2. MARCH.

\* \* \* \* \*

■ 127. (As changed by Change 1.) STACK ARMS.—a. The rifle squad being in line at normal or close interval, the commands are: 1. STACK, 2. ARMS. Numbers 2, 6, and 9 make the stacks except when no men are on the left of these numbers. The stack \* \* \* the stacking swivel. The stackman then throws the butt of his own rifle, barrel to the rear, 2 feet in advance of that of his left file and 6 inches to the right of his right toe;

# BASIC FIELD MANUAL

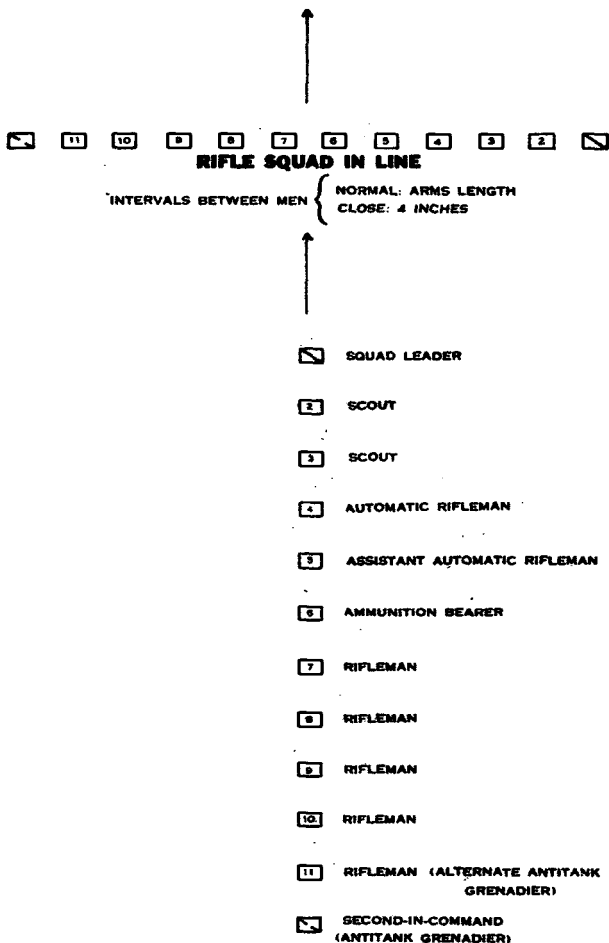

## **RIFLE SQUAD IN COLUMN** DISTANCE BETWEEN MEN 40 INCHES

FIGURE 25.—Rifle squad.

[A. G. 300.7 (8 Sep 43).] (C 3, 16 Sep 43.)

## INFANTRY DRILL REGULATIONS

at the same time he allows his right hand to slip to the stacking swivel and engages his rifle with that of his left file. The man on \* \* \* position of attention. Other rifles, and any carbines or automatic rifles of the squad are passed toward the nearest stack on the right and laid on the stack by the stackman.

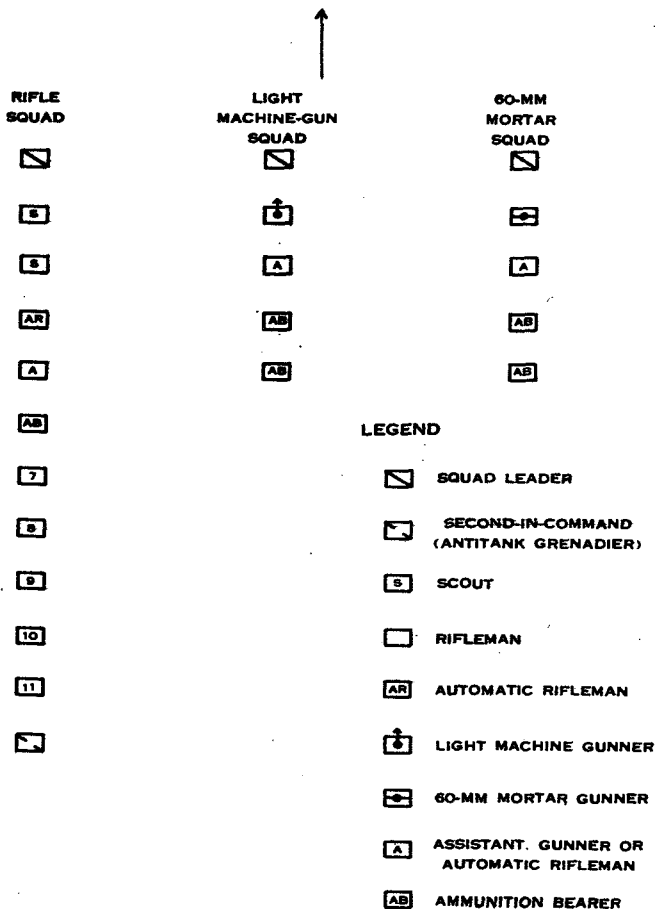
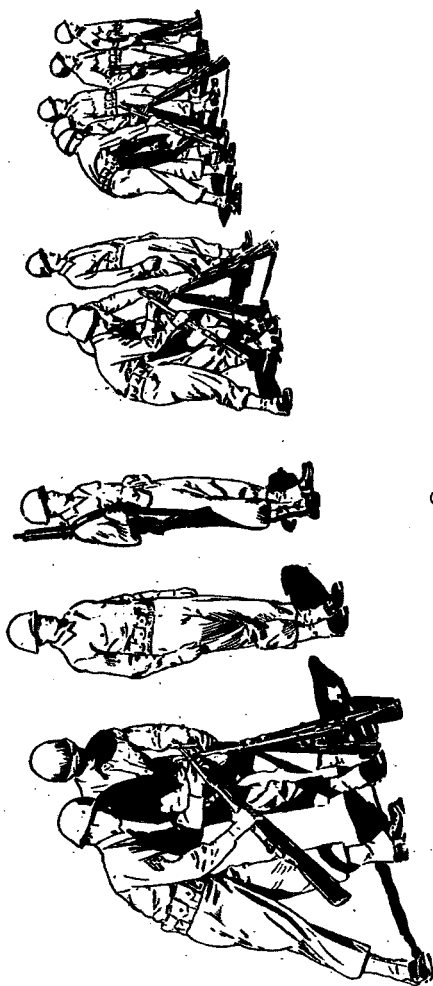

FIGURE 26.—Details of infantry rifle company squads.

[A. G. 300.7 (8 Sep 43).] (C 3, 16 Sep 43.)



BASIC FIELD MANUAL



① FIGURE 29.—Stack arms, rifle squad.

INFANTRY DRILL REGULATIONS

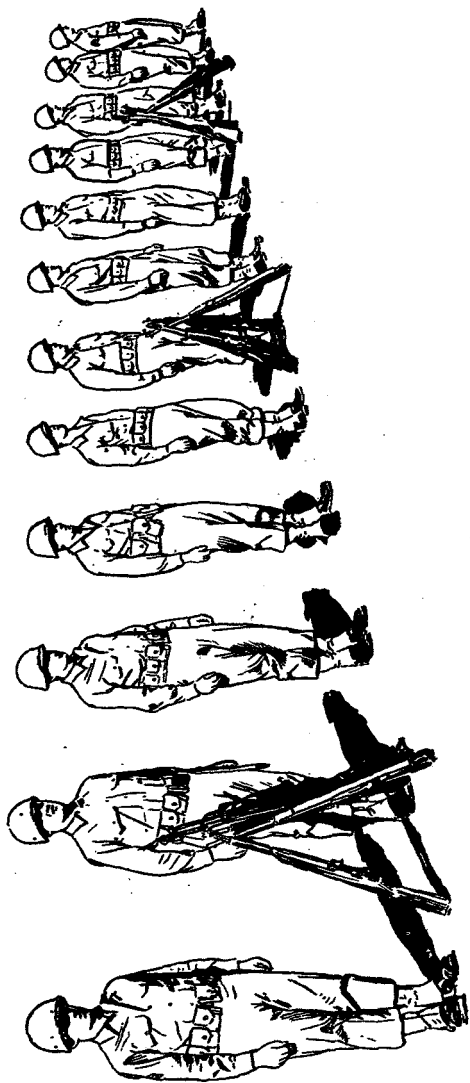

③  
FIGURE 29.—Continued.

## BASIC FIELD MANUAL

b. Rescinded.

c. Rescinded.

[A. G. 300.7 (8 Sep 43).] (C 3, 16 Sep 43.)

■ 130. COLUMN OF TWOS FROM SINGLE FILE AND RE-FORM.—*a* The squad being in column at a halt, to form column of twos the commands are: 1. **Column of Twos to the Left (Right)**, 2. **MARCH**. At the command **MARCH**, the leading man stands fast; the second man in the squad moves by the oblique until he is to the left of and abreast of the leading man (or squad leader) with normal distance and halts; the fourth man moves by the oblique until he is to the left of and abreast of the third man with normal interval, and halts; and so on.

*b*. The squad being in march in column of twos, to re-form single file, the squad is first halted. The commands are: 1. **Single File from the Right (Left)**, 2. **MARCH**. At the command \* \* \* in like manner.

*c*. (Added.) An element composed of one section only, being in column at a halt, executes **COLUMN OF TWOS FROM SINGLE FILE AND RE-FORM**, in the manner prescribed for the squad in *a* and *b* above.

*d*. (Added.) A section of two squads being in column (single file) at a halt, to form column of twos the commands are: 1. **COLUMN OF TWOS TO THE LEFT (RIGHT)**, 2. **MARCH**. At the command **MARCH**, the leading squad stands fast; the rear squad, by executing **COLUMN HALF LEFT AND COLUMN HALF RIGHT**, moves to its position to the left of and abreast of the leading squad, with normal interval, and halts.

*e*. (Added.) A section of two squads being in march in column of twos, to re-form single file, the section is first halted. The commands are: 1. **SINGLE FILE FROM THE RIGHT (LEFT)**, 2. **MARCH**. At the command **MARCH**, the right (leading) squad moves forward, the left (rear) squad follows the leading squad by executing **COLUMN HALF RIGHT AND COLUMN HALF LEFT**.

[A. G. 300.7 (8 Sep 43).] (C 3, 16 Sep 43.)

Figures 30 ① and ② are rescinded.

[A. G. 300.7 (8 Sep 43).] (C 3, 16 Sep 43.)

■ 131. FORMATIONS OF MORE THAN ONE SQUAD or Section.—*a*. The squads or sections form in line, one behind the other, with 40 inches distance between ranks.

*b*. Squads or sections are usually arranged to produce a two-, three-, four-, or six-rank formation, so that by facing to the

## INFANTRY DRILL REGULATIONS

right (left) the unit will march in column of twos, threes, fours, or sixes, depending on the number of squads or sections.

c. A platoon of three squads forms in three ranks of one squad each and marches in column of threes.

d. (Superseded.) A platoon composed of three sections of two squads each forms in three ranks of one section each, and marches in column of threes. However, when desirable, due to limited space or when the company is to be formed in mass formation, the platoon may form in column of sixes as shown in figure 46. When marching on roads, it forms in column of twos by sections.

e. (Superseded.) A platoon composed of two sections of two squads each forms in three ranks of one section each, and marches in column of fours.

f. (Superseded.) A platoon composed of two sections forms in two ranks of one section each, and marches in column of twos. It conforms to the movements prescribed for a section of two squads as prescribed in paragraph 130*d* and *e*.

g. Movements are described herein for COLUMN OF THREES and FOURS and may be executed by either formation. Movement in Column of Twos or Sixes is described where applicable to the unit.

\* \* \* \* \*

i. (1) The platoon being \* \* \* for physical training.

(2) (Added.) The platoon being in line, closes and extends as prescribed for the squad in paragraphs 120 and 121.

j. The platoon is \* \* \* paragraph 18, FM 21-20. The extension to the left is executed on the right squad, section, or platoon of the column which stands fast. The even-numbered men in all squads, sections, or platoons are designated to uncover.

[A. G. 300.7 (8 Sep 43).] (C 3, 16 Sep 43.)

### ■ 133. POSITION OF INDIVIDUALS.

\* \* \* \* \*

c. Other noncommissioned officers (such as mess and supply sergeants, clerks, technicians, etc.) and privates (such as cook's helpers and basics), whose positions are not otherwise prescribed, may be attached to platoons to equalize the strength thereof without interfering with the permanent squad organization. They fall in on the left when in line or in rear when platoons are in column (see par. 147).

[A. G. 300.7 (8 Sep 43).] (C 3, 16 Sep 43.)

## BASIC FIELD MANUAL

■ 134. FORM PLATOON.—*a.* (1) The command is: **FALL IN**. At the command **FALL IN**, the first squad forms in line on the squad leader as prescribed in paragraph 115*a*, its center opposite and 3 paces from the platoon sergeant. The other squads \* \* \* shown in figure 31.

(2) (Added.) When a platoon is composed of two sections, the sections form in line on the section leaders in a manner similar to that described for the squad.

(3) (Added.) When a platoon is composed of three sections of two squads each and the platoon is to form in three ranks, the sections form in line on the section leaders in a manner similar to that described for the squad.

\* \* \* \* \*

[A. G. 300.7 (8 Sep 43).] (C 3, 16 Sep 43.)

■ 135. DISMISS PLATOON.—The commands are: 1. **INSPECTION**, 2. **ARMS**, 3. **PORT**, 4. **ARMS**, 5. **DISMISSED**.

[A. G. 300.7 (8 Sep 43).] (C 3, 16 Sep 43.)

■ 136. MARCH PLATOON.—*a.* The normal formation for marching is in column of twos (three or fours) with squad (section) columns abreast, squad (section) leaders at the heads of their squads (sections).

\* \* \* \* \*

*c.* The platoon \* \* \*, 3. **FORWARD**, 4. **MARCH**. This marches the platoon in column of twos (threes or fours) to the right.

[A. G. 300.7 (8 Sep 43).] (C 3, 16 Sep 43.)

■ 138.1. (Added.) **BEING IN COLUMN OF TWOS AT NORMAL INTERVAL BETWEEN SECTIONS, MARCH (OR FORM) AT CLOSE INTERVAL**—

*a.* The commands are: 1. **CLOSE**, 2. **MARCH**. At the command **MARCH**, the section away from the guide closes to the right (left) by obliquing until the interval between men is 4 inches. The right (left) section takes up the half step until the dress has been regained. The distance, 40 inches, remains unchanged.

*b.* If this movement is executed from the halt, the section closes to the right (left) by executing **RIGHT OR LEFT STEP** until the 4-inch interval is reached.

[A. G. 300.7 (8 Sep 43).] (C 3, 16 Sep 43.)

■ 139.1. (Added.) **BEING IN COLUMN OF TWOS AT CLOSE INTERVAL BETWEEN SECTIONS, MARCH (OR FORM) AT NORMAL INTERVAL**—

*a.* The commands are: 1. **EXTEND**, 2. **MARCH**. At the command **MARCH**, the section away from the guide obliquates to the left (right) until the interval between men is one arm's length.

# INFANTRY DRILL REGULATIONS

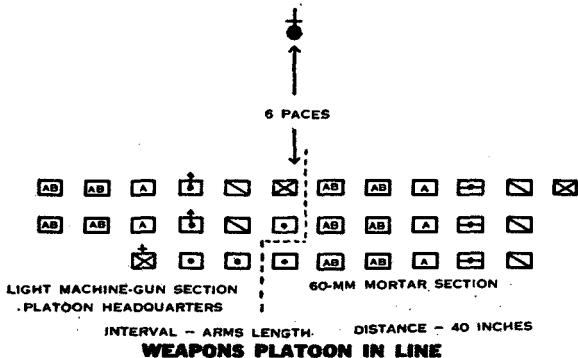
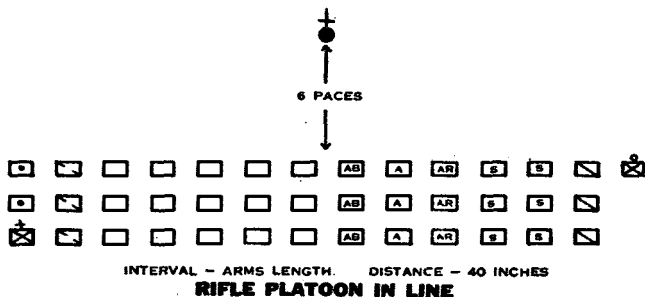

### LEGEND

- |   |  |
|---|--|
| <ul style="list-style-type: none"> <li> PLATOON LEADER</li> <li> PLATOON SERGEANT</li> <li> PLATOON GUIDE</li> <li> SERGEANT, SECTION LEADER</li> <li> SQUAD LEADER</li> <li> SCOUT</li> <li> RIFLEMAN</li> <li> SECOND-IN-COMMAND</li> </ul> | <ul style="list-style-type: none"> <li> AUTOMATIC RIFLEMAN</li> <li> LIGHT MACHINE GUNNER</li> <li> 60-MM MORTAR GUNNER</li> <li> ASSISTANT, GUNNER OF AUTOMATIC RIFLEMAN</li> <li> AMMUNITION BEARER</li> <li> MESSENGER</li> </ul> |
|---|--|

FIGURE 31.—Platoon formation.

[A. G. 300.7 (8 Sep 43).] (C 3, 16 Sep 43.)

b. If this movement is executed at the halt, the section executes LEFT or RIGHT STEP until it has secured the proper interval.

[A. G. 300.7 (8 Sep 43).] (C 3, 16 Sep 43.)



## INFANTRY DRILL REGULATIONS

■ 140. BEING IN COLUMN OF Twos (Threes or Fours), CHANGE DIRECTION.—The commands are: \* \* \* to his step. The rank(s) in rear of the leading rank executes the movement on the same ground and in the same manner as the leading rank.

[A. G. 300.7 (8 Sep 43).] (C 3, 16 Sep 43.)

■ 141. BEING IN COLUMN OF Twos (Threes or Fours), FORM LINE TO FRONT.—The commands are: \* \* \* direction is completed.

[A. G. 300.7 (8 Sep 43).] (C 3, 16 Sep 43.)

■ 144. BEING IN LINE, OPEN AND CLOSE RANKS.—a. (1) To open ranks the commands are: 1. OPEN RANKS, 2. MARCH, 3. READY, 4. FRONT. At the command MARCH, the front rank takes two steps forward, halts, and executes DRESS RIGHT. The second rank takes one step forward, halts, and executes DRESS RIGHT. The third rank stands fast and executes DRESS RIGHT. The fourth rank, if any, takes two steps backward and executes DRESS RIGHT. In a unit formed in six ranks, the sixth rank takes six steps backward, halts, and executes Dress Right: the fifth rank takes four steps backward, halts, and executes Dress Right. The platoon leader, moving by the most direct route, places himself on the flank of the platoon toward which the dress is made, one pace from and in prolongation of the front rank and facing down the line. From this position \* \* \* commands: 1. READY, 2. FRONT.

(2) (Added.) In a platoon composed of two sections, at the command MARCH, the front rank takes two steps forward, halts, and executes DRESS RIGHT. The rear rank takes one step forward, halts, and executes DRESS RIGHT.

b. (1) To close ranks, the commands are: 1. CLOSE RANKS, 2. MARCH. At the command MARCH, the front rank stands fast; the second rank takes one step forward and halts; the third rank takes two steps forward and halts; and the fourth, fifth, and sixth ranks, if any, take three, four, and five steps forward respectively and halt. Each man covers his file leader.

(2) (Added.) In a platoon composed of two sections, at the command MARCH, the front rank stands fast; the rear rank takes one step forward and halts. Each man covers his file leader.

[A. G. 300.7 (8 Sep 43).] (C 3, 16 Sep 43.)



## BASIC FIELD MANUAL

### ■ 145. FORM FOR SHELTER TENTS.

\* \* \* \* \*

a. At the command \* \* \* the front rank. The messengers take position on the left of the left man of the rear rank.

b. (1) At the command \* \* \* already on line.

(2) (Added.) In a platoon composed of two sections, formed in two ranks, the front rank stands fast, and the rear rank faces to the left in marching and steps off. The section leader gives the appropriate commands to bring his section into line abreast of the section already on line.

\* \* \* \* \*

e. To assemble, the platoon is faced to the right and re-formed from single file into column of twos (threes or fours) to the right (left) as prescribed in paragraph 146c(2) and e(2). The Platoon sergeant and messengers resume their normal posts.

[A. G. 300.7 (8 Sep 43).] (C 3, 16 Sep 43.)

### ■ 146. COLUMN OF TWOS AND SINGLE FILE AND RE-FORM.

\* \* \* \* \*

a. (1) (a) The platoon being \* \* \* THE RIGHT (LEFT), 2. MARCH. At the command MARCH, the right two squads march forward: the left squad forms column of twos to the left as prescribed for the squad and then executes COLUMN HALF RIGHT and COLUMN HALF LEFT so as to follow in column the leading squads. Forty-inch distances are maintained.

(b) (Added.) A platoon of three sections of two squads each being in column of threes at a halt, to form column of twos the commands are: 1. COLUMN OF TWOS FROM THE RIGHT (LEFT), 2. MARCH. At the command MARCH, the two right sections (center and right) march forward. The rear squad of the left section, by executing COLUMN HALF RIGHT as the two right sections clear its position, and then COLUMN HALF LEFT, follows in trace the right section. The leading squad of the left section, by executing COLUMN HALF RIGHT as the two right sections clear its position, and then COLUMN HALF LEFT, follows in trace the center section, and abreast of the rear squad. Column of twos from the left is executed in a similar manner (see fig. 34.1).

# INFANTRY DRILL REGULATIONS

## 1. COLUMN OF TWOS FROM COLUMN OF THREES

(PLATOON OF THREE SECTIONS OF TWO SQUADS EACH)

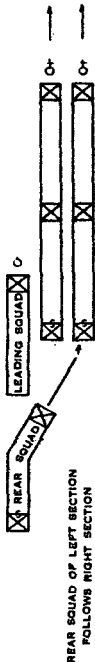
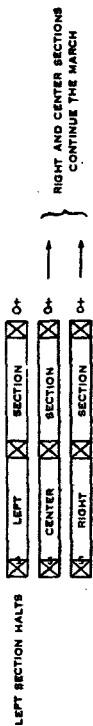

REAR SQUAD OF LEFT SECTION  
FOLLOWS RIGHT SECTION

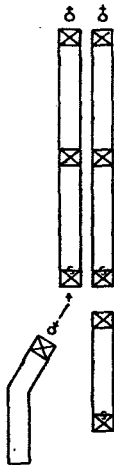

LEADING SQUAD, LEFT SECTION,  
FOLLOWS CENTER SECTION

## 2. RE-FORM

LEADING SQUAD, LEFT SECTION,  
MOVES UP ON LINE WITH  
LEADING RANKS OF RIGHT AND  
CENTER SECTIONS, FOLLOWED  
BY REAR SQUAD.

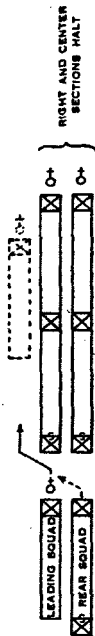

FIGURE 34.1.—Column of twos from column of threes and re-form.

[A. G. 300.7 (8 Sep 43).] (C 3, 16 Sep 43.)

## BASIC FIELD MANUAL

(2) (a) The platoon being \* \* \* 1. COLUMN OF THREES TO THE LEFT (RIGHT), 2. MARCH. At the command MARCH, the leading two squads stand fast. The rear squad forms single file from the right, as indicated in figure 34, moving into its normal place beside the leading squads by executing COLUMN HALF LEFT, then COLUMN HALF RIGHT.

(b) (Added.) A platoon of three sections of two squads each being in column of twos at a halt, to re-form in column of threes, the commands are: 1. COLUMN OF THREES TO THE LEFT (RIGHT), 2. MARCH. At the command MARCH, the two leading (center and right) sections stand fast. The left squad of the rear (left) section, by executing COLUMN HALF LEFT and COLUMN HALF RIGHT moves to its normal place beside the center section. It is halted when its leading file is on line with the leading rank of the platoon. The right squad of the rear (left) section, by executing COLUMN HALF LEFT at the proper time, follows in trace the left squad. (See fig. 34.1 ②.)

\* \* \* \* \*

c. (1) The platoon being \* \* \* LEFT (RIGHT), 2. MARCH. At the command MARCH, the right squad (section) of the platoon moves forward. The other squads (sections) stand fast initially and then successively follow the leading squad (section) by executing COLUMN HALF RIGHT and COLUMN HALF LEFT. Distances of 40 inches are maintained.

(2) The platoon being \* \* \* LEFT (RIGHT), 2. MARCH. At the command MARCH, the leading squad (section) stands fast. The other squads (sections) move to their normal places by executing COLUMN HALF LEFT then at the proper time COLUMN HALF RIGHT, and are halted when the leading file is on line with the leading rank of the platoon.

d. (Superseded.) (1) A platoon of three sections of two squads each being in column of sixes at a halt, to form column of twos, the commands are: 1. COLUMN OF TWOS FROM THE RIGHT (LEFT), 2. MARCH. At the command MARCH, the right two squads march forward; the left four squads initially stand fast; then in turn from right to left follow the leading two squads, in column of twos, by executing COLUMN HALF RIGHT and COLUMN HALF LEFT. Forty-inch distances are maintained.

(2) A platoon of three sections of two squads each being in column of twos at a halt, to re-form in column of sixes, the

## INFANTRY DRILL REGULATIONS

commands are: 1. **COLUMN OF SIXES TO THE LEFT (RIGHT)**, 2. **MARCH**. At the command **MARCH**, the leading two squads stand fast. The four rear squads move simultaneously to their normal places by executing **COLUMN HALF LEFT** and then, when opposite their places, **COLUMN HALF RIGHT**; they are halted when the leading files are on line with the leading rank of the platoon.

e. (Added.) (1) Being in column of twos at a halt, to form single file, the commands are: 1. **COLUMN OF FILES FROM THE RIGHT (LEFT)** 2. **MARCH**.

(a) *Platoon of two sections.*—At the command **MARCH**, the right section of the platoon moves forward. The left section stands fast initially and then follows the leading section by executing **COLUMN HALF RIGHT** and **COLUMN HALF LEFT**.

(b) *Platoon of three squads.*—At the command **MARCH**, the right squad of the platoon moves forward. The left squad stands fast initially and then follows the leading squad by executing **COLUMN HALF RIGHT** and **COLUMN HALF LEFT**. The rear squad stands fast initially and then follows the preceding squad by forming single file as prescribed for the squad in paragraph 130b.

(c) *Platoon of two sections of two squads each.*—At the command **MARCH**, the right leading squad moves forward; the other three squads stand fast initially. The left leading squad follows by executing **COLUMN HALF RIGHT** and **COLUMN HALF LEFT**; and is followed in turn by the right and left rear squads.

(d) *Platoon of three sections of two squads each.*—The movement is executed in a similar manner to (c) above. The fifth and sixth squads follow in turn the third and fourth squads.

(2) Being in single file at a halt, to re-form in column of twos the commands are: 1. **COLUMN OF TWOS TO THE LEFT (RIGHT)**, 2. **MARCH**.

(a) *Platoon of two sections.*—At the command **MARCH**, the leading section stands fast. The rear section moves to the left of the leading section by executing **COLUMN HALF LEFT**, then at the proper time **COLUMN HALF RIGHT**, and halts when the leading file is on line with the leading file of the first section.

(b) *Platoon of three squads.*—At the command **MARCH**, the leading squad stands fast. The second squad in column moves to the left of the leading squad by executing **COLUMN HALF LEFT**.

## BASIC FIELD MANUAL

then at the proper time **COLUMN HALF RIGHT**, and halts when the leading file is on line with the leading file of the preceding squad. The rear squad moves forward, halting 40 inches from the rear of the leading squads and forms column of twos as prescribed in paragraph 130a.

(c) *Platoon of two sections of two squads each.*—At the command **MARCH**, the leading squad stands fast. The second squad in column moves to the left of the leading squad by executing **COLUMN HALF LEFT**, then at the proper time **COLUMN HALF RIGHT**, and halts when the leading file is on line with the leading file of the preceding squad. The third squad in column moves forward, halting 40 inches from the rear of the right leading squad. The fourth squad moves to the left of the third squad in column by executing **COLUMN HALF LEFT**, then at the proper time **COLUMN HALF RIGHT**, halting when the leading file is on line with the leading file of the preceding squad.

(d) *Platoon of three sections of two squads each.*—The movement is executed in a similar manner to (c) above. The fifth and sixth squads move to their proper place in column as described for the third and fourth squads above. The members of platoon headquarters, if present, retain their respective positions at the rear of the sections, unless otherwise prescribed.

f. (Added.) Whenever commands are given involving movements of squads or sections in which a squad or section stands fast, takes up the march, continues the march, or changes formation, the squad or section leader gives the appropriate commands.

[A. G. 300.7 (8 Sep 43).] (C 3, 16 Sep 43.)

### ■ 147. GENERAL.

\* \* \* \* \*

b. For close order drill and ceremonies, company headquarters personnel present are attached to platoons to equalize the strength thereof, but without interfering with the permanent squad organization. For marches or special purposes, members of the company headquarters command group are formed as shown in figure 36, or as directed by the company commander or higher authority.

c. The first sergeant takes post as follows for drills and ceremonies:

## INFANTRY DRILL REGULATIONS

(1) *With company in line.*—(a) At normal distance in rear of the right flank man of the rear rank of the left center (or center) platoon.

b. (Added.) In a company composed of two platoons, he takes position at normal distance in rear of the right flank man of the rear rank of the left platoon.

(c) (Added.) In a company composed of platoons of two sections, he takes position at normal distance in rear of the section leader of the rear section of the center platoon.

(2) *With company in column of platoons (platoons being in column of twos, threes, or fours).*—At normal distance \* \* \* shown in figure 36.

\* \* \* \* \*

[A. G. 300.7 (8 Sep 43).] (C 3, 16 Sep 43.)

■ 149. **FORM COMPANY.**—a. The first sergeant \* \* \* point and commands: **FALL IN.** At the command **FALL IN**, the company forms in two (three or four) ranks with normal interval between men (unless close interval is directed) and 3-pace intervals between platoons as indicated in figure 35.

b. Each platoon sergeant takes post 3 paces in front of the point where the center of his platoon will be. The platoons then form as prescribed in paragraph 134, under the supervision of the platoon sergeants.

c. The platoon sergeants then command: **REPORT.** \* \* \* or "Private ——— absent." Platoon sergeants then command: 1. **INSPECTION**, 2. **ARMS**, 3. **Order**, 4. **ARMS**, and face about. Men armed with \* \* \* or "——— men absent."

\* \* \* \* \*

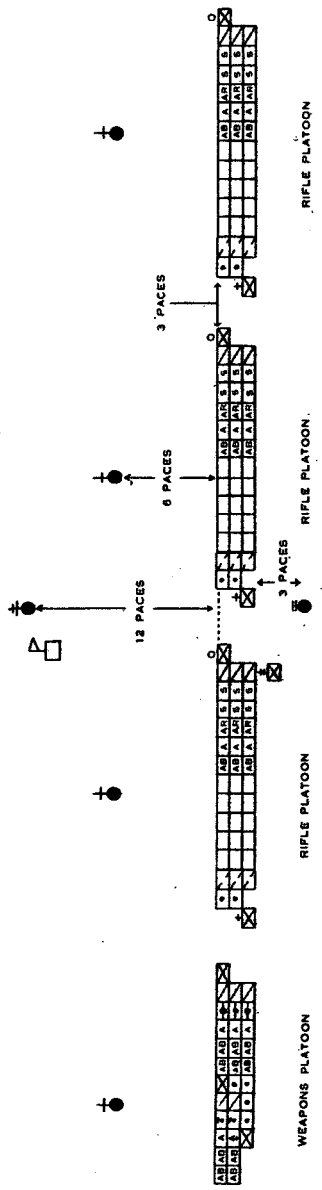



















WEAPONS PLATOON

RIFLE PLATOON

RIFLE PLATOON

FIGURE 35.—Rifle company in line.

LEGEND

	COMPANY COMMANDER		SERGEANT SECTION LEADER		LIGHT MACHINE GUNNER
	SECOND-IN-COMMAND		SQUAD LEADER		60-MM MORTAR GUNNER
	PLATOON LEADER		ASSISTANT SQUAD LEADER		AMMUNITION BEARER
	FIRST SERGEANT		RIFLEMAN		SCOUT
	PLATOON SERGEANT		GUIDON BEARER		MESSENGER
	PLATOON GUIDE		AUTOMATIC RIFLEMAN		
			ASSISTANT, AUTOMATIC RIFLEMAN OR GUNNER		

NOTES: 1. FOR DISPOSITION OF COMPANY HEADQUARTERS PERSONNEL NOT SHOWN, SEE PAR. 147.

2. FOR DISPOSITION OF COMPANY TRANSPORT SEE PAR. 163. TRUCK DRIVERS NOT SHOWN.

FIGURE 35.—Continued.

[A. G. 300.7 (8 Sep 43).] (C 3, 16 Sep 43.)



# BASIC FIELD MANUAL

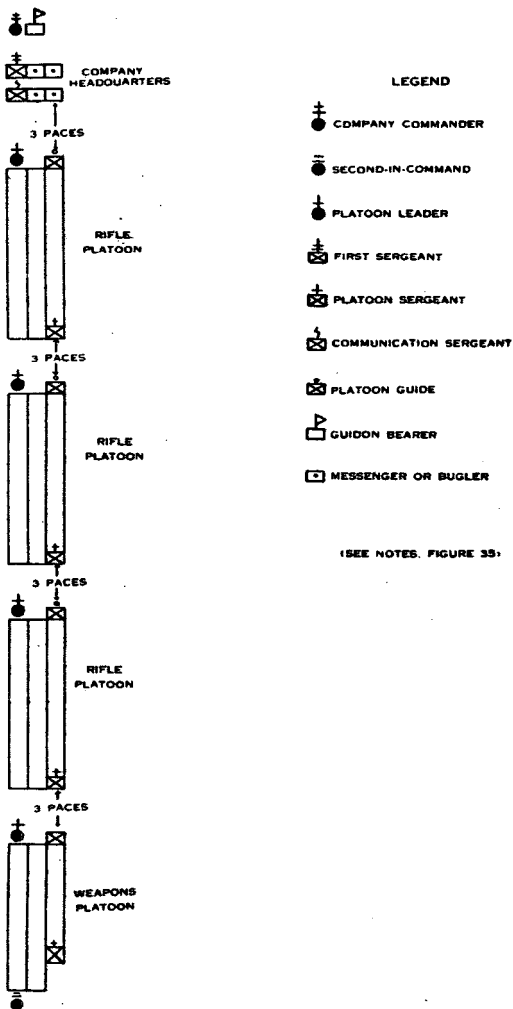

**FIGURE 36.—Rifle company in march formation.**  
 [A. G. 300.7 (8 Sep 43).] (C 3, 16 Sep 43.)

# INFANTRY DRILL REGULATIONS

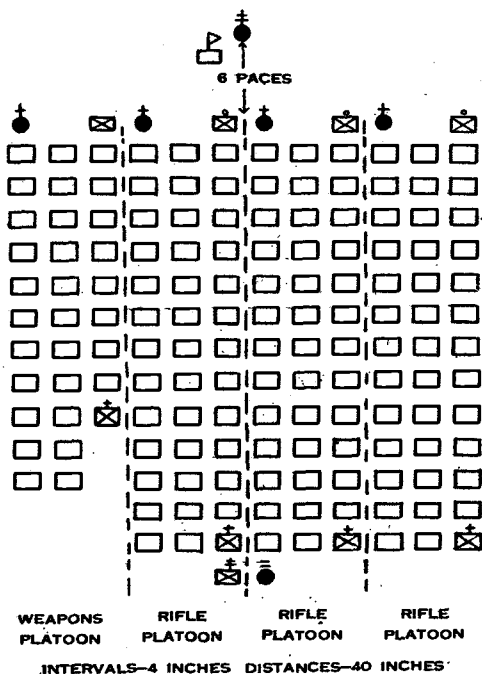

## LEGEND

- |   |   |
|---|---|
| <p>☉ COMPANY COMMANDER</p> <p>☉ SECOND-IN-COMMAND</p> <p>☉ PLATOON LEADER</p> <p>☉ FIRST SERGEANT</p> | <p>☒ PLATOON SERGEANT</p> <p>☒ PLATOON GUIDE</p> <p>☐ GUIDON BEARER</p> |
|---|---|

(SEE NOTES: FIGURE 35)

FIGURE 37.—Rifle company in mass formation.  
 [A. G. 300.7 (8 Sep 43).] (C 3, 16 Sep 43.)

## BASIC FIELD MANUAL

e. If the platoons cannot be formed in regularly organized squads, the platoon sergeants command: 1. **INSPECTION**, 2. **ARMS**, 3. **Right Shoulder**, 4. **ARMS**, and call the rolls. Each man as \* \* \* as described above.

f. (1) The company commander \* \* \* the first sergeant. The second in command and officers commanding platoons take their posts immediately after the first sergeant has reported and, when so armed, draw saber with the company commander.

(2) (Added.) When armed with the carbine the second-in-command and officers commanding platoons stand at attention with the piece in the carrying position.

\* \* \* \* \*

[A. G. 300.7 (8 Sep 43).] (C 3, 16 Sep 43.)

■ 152. **DISMISS COMPANY.**—a. The company being in line at a halt, the company commander directs the first sergeant, "Dismiss the company." The officers fall out; the first sergeant moves to a point 9 paces in front of the center of the company, salutes the company commander, faces toward the company, and commands: 1. **INSPECTION**, 2. **ARMS**, 3. **PORT**, 4. **ARMS**, 5. **DISMISSED**.

b. Dismissal may also \* \* \* the platoon sergeants. Each platoon sergeant takes post 3 paces in front of the center of his platoon and commands: 1. **INSPECTION**, 2. **ARMS**, 3. **PORT**, 4. **ARMS**, 5. **DISMISSED**.

[A. G. 300.7 (8 Sep 43).] (C 3, 16 Sep 43.)

■ 153. **ALINE COMPANY.**—a. The company being in line at a halt, to aline the company the command of the company commander is: **DRESS RIGHT (CENTER or LEFT)**. At the command **DRESS RIGHT**, the platoon leader of the base platoon dresses his platoon immediately by the commands, 1. **Dress Right**, 2. **DRESS**, 3. **Ready**, 4. **FRONT**. When **DRESS CENTER** is given, the leader of the center platoon dresses his platoon to the right in the same manner. Each platoon leader dresses his platoon toward the center (right or left) of the company as soon as the base platoon or the platoon next toward the base platoon has completed its dress.

b. (Added.) The company being in mass formation at a halt, to aline the company the commands of the company commander

## INFANTRY DRILL REGULATIONS

are: 1. DRESS RIGHT (LEFT), 2. DRESS, 3. READY, 4. FRONT. The alinement of each rank is verified expeditiously by the platoon leader of the base platoon. When the platoon leader resumes his post the company commander then commands: 3. READY, 4. FRONT.

[A. G. 300.7 (8 Sep 43).] (C 3, 16 Sep 43.)

■ 155. BEING IN COLUMN OF TWOS, THREES, OR FOURS AT CLOSE INTERVAL, FORM COMPANY MASS.—*a.* The company being \* \* \* platoon stands fast. The rear platoon(s) moves to position alongside the leading platoon(s) at 4-inch intervals by executing COLUMN HALF LEFT then COLUMN HALF RIGHT. Each platoon is \* \* \* men in ranks.

\* \* \* \* \*

[A. G. 300.7 (8 Sep 43).] (C 3, 16 Sep 43.)

■ 156. BEING IN COLUMN OF TWOS, THREES, OR FOURS, FORM EXTENDED MASS FORMATION.—The commands are: 1. COMPANY MASS — PACES LEFT (RIGHT), 2. MARCH. At the command MARCH, the movement is executed as described in paragraph 155 except that the rear platoon(s) moves to position alongside the leading platoon(s) at the intervals ordered by executing COLUMN LEFT and COLUMN RIGHT. Each platoon is \* \* \* in paragraph 241.

[A. G. 300.7 (8 Sep 43).] (C 3, 16 Sep 43.)

■ 158. BEING IN COMPANY MASS, FORM COLUMN OF TWOS, THREES, OR FOURS.—Being at a halt, the commands are: 1. COLUMN OF TWOS (THREES OR FOURS), 2. RIGHT PLATOON, FORWARD, 3. MARCH. At the command MARCH the right platoon marches forward. The other platoon(s) follows in column in its normal formation by executing COLUMN HALF RIGHT and COLUMN HALF LEFT upon the commands of its leader.

[A. G. 300.7 (8 Sep 43).] (C 3, 16 Sep 43.)

## CHAPTER 6

## DRILL FOR UNITS WITH MOTORS

[A. G. 300.7 (8 Sep 43).] (C 3, 16 Sep 43.)

■ 162. PURPOSE.—*a.* This chapter provides drill for units having motor vehicles to transport weapons, ammunition, or other combat equipment but possessing insufficient transportation to carry all personnel of the organization. In this type of unit, the minimum personnel necessary to operate the weapons should accompany them when they are on the company transport. Others march on foot. Units to which this drill may apply are—

(1) Machine gun and mortar units.

(2) Headquarters and other units which have motor vehicles to transport their combat equipment.

*b.* (Superseded.) For drill for units (such as the battalion antitank platoon, the antitank company, and the cannon company), which have sufficient transportation to carry all personnel, see chapter 7.

*c.* (Added.) The drill covered in sections II, III, and IV of this chapter is prepared for the heavy weapons company. Units mentioned in *a*(2) above must adapt this drill to fit their own organization and equipment.

*d.* (Added.) The sole purpose of the drill is the orderly formation and movement of such units. It is practiced for smoothness of execution. All personnel must be proficient in drill for foot troops.

[A. G. 300.7 (8 Sep 43).] (C 3, 16 Sep 43.)

■ 163. TRANSPORTATION.—*a.* (Superseded.) This drill is based on the assumption that, when fully equipped, there is one truck per squad. Each unit not fully equipped, or provided with motor transportation on a different basis from that given above, should adapt this drill to fit its own requirements.

*b.* (Superseded.) Normally in the heavy weapons company, the company commander, reconnaissance sergeant, and two messengers (one driving truck) in one truck; and the reconnaissance officer (second-in-command), messenger (driving truck), and communication sergeant in another truck, ride at

## INFANTRY DRILL REGULATIONS

the head of the company. The first sergeant and bugler march with the foot elements of the unit. The transportation sergeant and supply sergeant ride in another truck driven by the mechanic at the rear of the company. In other units, the personnel of company headquarters is similarly disposed. Platoon commanders march on foot with their platoons at drill with transport.

c. In the heavy weapons company the fire-control equipment of the platoon is carried in the platoon commander's truck or on one of the squad trucks. The fire-control equipment of the company is carried in the company commander's truck, and eight sets of Reel Equipment CE-11 in the reconnaissance officer's truck.

\* \* \* \* \*

e. (Added.) In formations combining both foot elements and motors, the vehicles will be arranged in accordance with instructions of the regimental or battalion commander. (See par. 171.)

[A. G. 300.7 (8 Sep 43).] (C 3, 16 Sep 43.)

■ 164. RULES FOR MEN ARMED WITH RIFLE.—Men armed with \* \* \* manual of arms. At all formations for drill and ceremonies, such men fall in at ORDER ARMS and after executing INSPECTION ARMS, as prescribed in paragraphs 43 and 44, upon command will execute SLING ARMS as prescribed in paragraph 39a. Rifles remain at \* \* \* rest or at ease.

[A. G. 300.7 (8 Sep 43).] (C 3, 16 Sep 43.)

■ 165. ORGANIZATION OF SQUAD.—a. The weapons squad (machine gun or mortar) consists of a squad leader and men to operate the weapon and to serve it with ammunition.

b. (Superseded.) The weapons, their accessories, ammunition, and the minimum personnel necessary to operate the weapons are transported by the squad truck. The other members of the section march on foot.

c. The squad secures and carries equipment and forms as prescribed in the drill for the weapon. Whenever the squad \* \* \* directs, "Carry equipment."

[A. G. 300.7 (8 Sep 43).] (C 3, 16 Sep 43.)

■ 170. ORGANIZATION.—a. The platoon consists of a headquarters and two or more squads or sections.

## BASIC FIELD MANUAL

b. The trucks of the platoon are grouped under the command of the transportation corporal who rides in the platoon commander's truck which is on the right, when in line and in the lead, when in column. He controls the vehicles by command or by arm signals prescribed in paragraph 325.

(A. G. 300.7 (8 Sep 43).] (C 3, 16 Sep 43.)

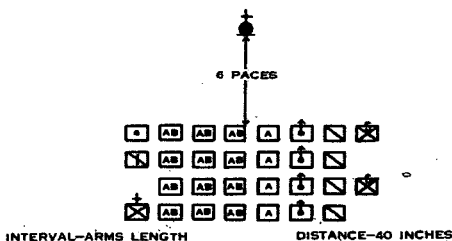

① CALIBER .30 HEAVY MACHINE-GUN PLATOON IN LINE

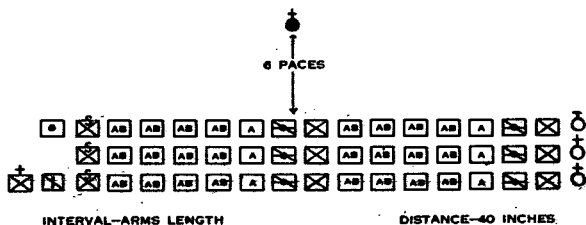

② 81-MM MORTAR PLATOON IN LINE (THREE RANKS)

FIGURE 41.—Formations of platoons of the heavy weapons company.

# INFANTRY DRILL REGULATIONS

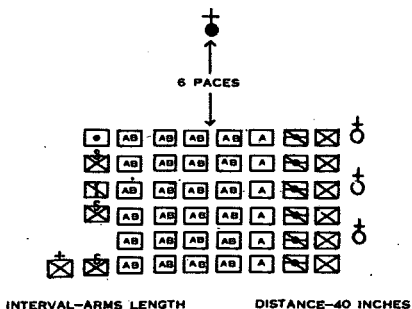

③ 81-MM MORTAR PLATOON IN LINE (SIX RANKS)

NOTE: PERSONNEL CONCERNED WITH OPERATION AND MAINTENANCE OF TRANSPORT,  
NOT INCLUDED IN DIAGRAM

### LEGEND

<p>⊕ PLATOON LEADER</p> <p>♀ SECTION LEADER, MORTAR</p> <p>⊗ PLATOON SERGEANT</p> <p>⊗ SECTION LEADER, OR SECTION SERGEANT</p> <p>⊗ SERGEANT</p> <p>⊗ CORPORAL</p>	<p>⊗ CORPORAL MORTAR GUNNER</p> <p>⊗ CORPORAL INSTRUMENT</p> <p>⊗ MACHINE GUNNER</p> <p>⊗ ASSISTANT GUNNER</p> <p>⊗ AMMUNITION BEARER</p> <p>⊗ MESSENGER</p>
--	--

FIGURE 41.—Continued.

[A. G. 300.7 (8 Sep 43).] (C 3, 16 Sep 43.)



## BASIC FIELD MANUAL

■ 171. FORMATION WITH MOTOR TRANSPORTATION.—*a.* The platoons of the heavy weapons company are formed in line as shown in figure 41. When motors are present they form in column(s), or as prescribed, 3 paces in rear. When the platoons are in column, the motors form in column three paces in rear of the last man in column when halted, and six paces when moving. Additional noncommissioned officers \* \* \* is in column.

*b.* In forming the platoon in either line or column, the transport may move to the selected position and the foot elements then form in front of it, or the foot elements, after loading the trucks, may form first and the trucks then take their proper positions.

*c.* The distance between trucks in column is 3 paces when halted and 6 paces when moving. When the transport is operating independently, other prescribed or suitable road distances and speeds are used. The interval between \* \* \* than 3 paces.

\* \* \* \* \*

[A. G. 300.7 (8 Sep 43).] (C 3, 16 Sep 43.)

■ 179. FORMATION WITH MOTOR TRANSPORT.—The procedure is similar to that prescribed for the platoon in paragraphs 163 and 171. The second in command \* \* \* in paragraph 149.

[A. G. 300.7 (8 Sep 43).] (C 3, 16 Sep 43.)

■ 180. FORMATIONS.—The formations of the company with motor vehicles are LINE, COLUMN, and MASS. The foot elements of the heavy weapons company are shown in LINE, in COLUMN, and in MASS in figures 44, 45, and 46. The foot elements of the battalion headquarters company are shown in Line and in Mass in figures 46.1 and 46.2. The regimental headquarters company is shown in LINE and in MASS in figures 47 and 48. For disposition of transport, see paragraphs 163 and 171.

[A. G. 300.7 (8 Sep 43).] (C 3, 16 Sep 43.)

■ 181. BEING IN LINE, FORM COLUMN.—The commands are: \* \* \* for the platoon. The vehicles wait until the last platoon of the company's foot elements has passed and then follow

## INFANTRY DRILL REGULATIONS

in column as prescribed by the unit commander. See paragraphs 163 and 171.

[A. G. 300.7 (8 Sep 43).] (C 3, 16 Sep 43.)

■ 182. BEING IN COLUMN, AT CLOSE INTERVAL, FORM COMPANY MASS.—*a.* The company being \* \* \* in paragraph 156. As soon as the foot elements are in place, the vehicles move forward and form in columns in rear of their respective platoons as prescribed by the company or higher commander.

\* \* \* \* \*

[A. G. 300.7 (8 Sep 43).] (C 3, 16 Sep 43.)

■ 183. BEING IN MASS FORMATION, FORM COLUMN OF TWOS, (THREES OR FOURS).—Being at a halt, the commands are: 1. COLUMN OF TWOS (THREES OR FOURS), 2. RIGHT PLATOON, FORWARD, 3. MARCH. At the command \* \* \* in paragraph 153. As soon as the foot elements have completed the movement, the motor vehicles of the right platoon move forward to position at the rear of the foot elements, followed in column, successively, by the vehicles of the other platoons. (See fig. 55.)

[A. G. 300.7 (8 Sep 43).] (C 3, 16 Sep 43.)

■ 183.1. (Added.) BEING IN MASS FORMATION, FORM COLUMN OF THREES, FOURS, AND SIXES.—Being at a halt, the commands are: 1. COLUMN OF FOURS (THREES) AND SIXES, 2. RIGHT PLATOON, FORWARD, 3. MARCH. At the command MARCH, the foot elements execute the movement as prescribed for foot troops in paragraph 158. As soon as the foot elements have completed the movement, the motor vehicles of the right platoon move forward to positions at the rear of the foot elements followed in column, successively, by the vehicles of the other platoons. (See fig. 55.)

[A. G. 300.7 (8 Sep 43).] (C 3, 16 Sep 43.)

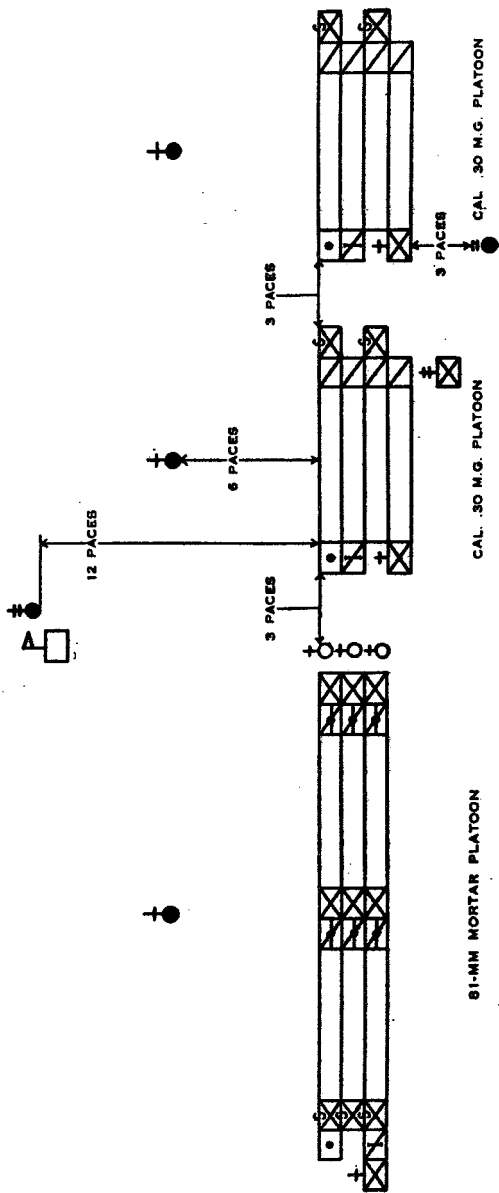

NOTES:

1. FOR DISPOSITION OF COMPANY HEADQUARTERS PERSONNEL NOT SHOWN IN DIAGRAM, SEE PAR. 178f
2. FOR DISPOSITION OF COMPANY TRANSPORT, SEE PAR. 163 AND 171. PERSONNEL CONCERNED WITH OPERATION AND MAINTENANCE OF TRANSPORT NOT SHOWN
3. SEE FIGURE 41 FOR ALTERNATIVE FORMATION OF 81-MM MORTAR PLATOON

FIGURE 44.—Heavy weapons company in line.

LEGEND

☼	COMPANY COMMANDER	☼	FIRST SERGEANT	☼	CORPORAL, MORTAR GUNNER
☼	SECOND-IN-COMMAND	☼	PLATOON SERGEANT	☼	CORPORAL, INSTRUMENT
☼	PLATOON LEADER	☼	SECTION LEADER OR SECTION SERGEANT	☼	GUIOON BEARER
☼	SECTION LEADER, MORTAR	☼	SERGEANT	☼	MESSENGER
		☼	CORPORAL		

FIGURE 44.—Continued.

[A. G. 300.7 (8 Sep 43).] (C 3, 16 Sep 43.)

# BASIC FIELD MANUAL

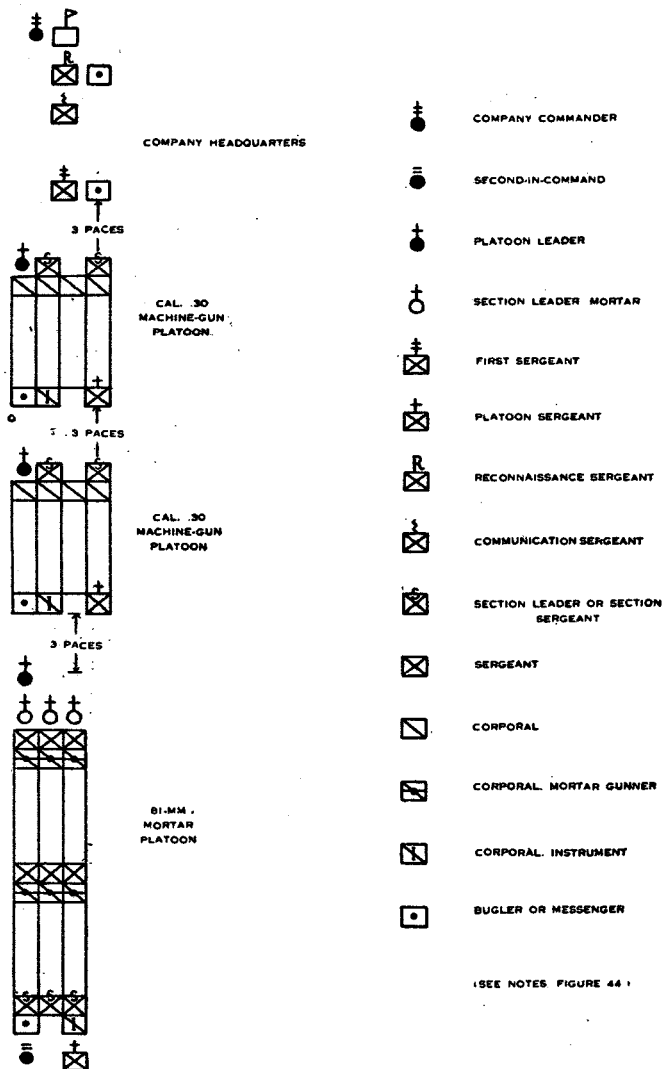
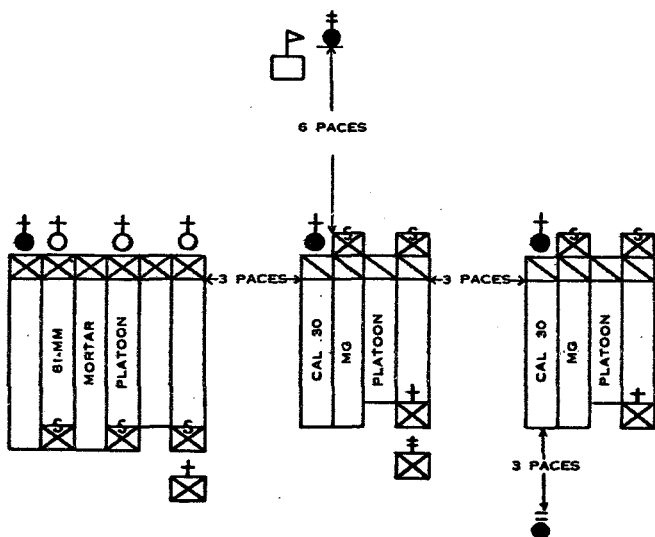

FIGURE 45.—Heavy weapons company in column.

[A. G. 300.7 (8 Sep 43).] (C 3, 16 Sep 43.)

# INFANTRY DRILL REGULATIONS.



(SEE NOTES. FIGURE 44)

### LEGEND

- |   |  |
|---|--|
| <ul style="list-style-type: none"> <li> COMPANY COMMANDER</li> <li> SECOND-IN-COMMAND</li> <li> PLATOON LEADER</li> <li> SECTION LEADER, MORTAR</li> <li> FIRST SERGEANT</li> </ul> | <ul style="list-style-type: none"> <li> PLATOON SERGEANT</li> <li> SECTION LEADER OR SECTION SERGEANT</li> <li> SERGEANT</li> <li> CORPORAL</li> <li> GUIDON BEARER</li> </ul> |
|---|--|

FIGURE 46.—Heavy weapons company in mass formation.

[A. G. 300.7 (8 Sep 43).] (C 3, 16 Sep 43.)

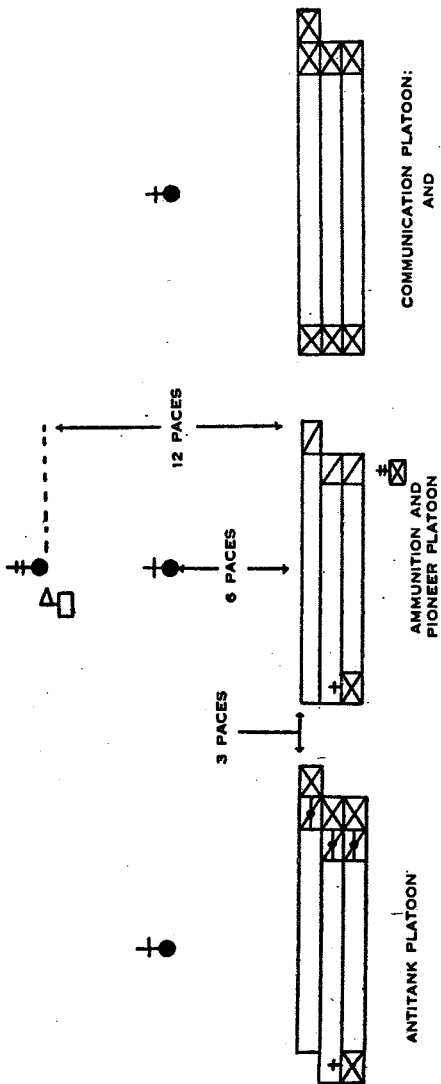









FIGURE 46.1.—Battalion headquarters company in line.

# INFANTRY DRILL REGULATIONS

## LEGEND

	COMPANY COMMANDER		SERGEANT
	PLATOON LEADER		CORPORAL
	FIRST SERGEANT		CORPORAL GUNNER
	PLATOON SERGEANT		GUIDON BEARER

### NOTES:

1. FOR DISPOSITION OF COMPANY HEADQUARTERS PERSONNEL NOT SHOWN IN DIAGRAM, SEE PAR. 178c.
2. FOR DISPOSITION OF COMPANY TRANSPORT, SEE PARS. 163 AND 171. PERSONNEL CONCERNED WITH ITS OPERATION AND MAINTENANCE NOT SHOWN.

FIGURE 46.1.—Continued.

[A. G. 300.7 (8 Sep 43).] (C 3, 16 Sep 43.)



# BASIC FIELD MANUAL

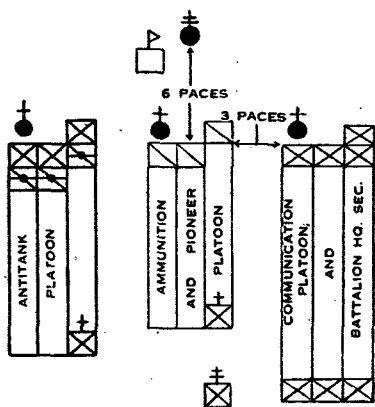

## LEGEND









	COMPANY COMMANDER		SERGEANT
	PLATOON LEADER		CORPORAL
	FIRST SERGEANT		CORPORAL GUNNER
	PLATOON SERGEANT		GUIDON BEARER

FIGURE 46.2.—Battalion headquarters company in mass formation.

[A. G. 300.7 (8 Sep 43).] (C 3, 16 Sep 43.)

# INFANTRY DRILL REGULATIONS

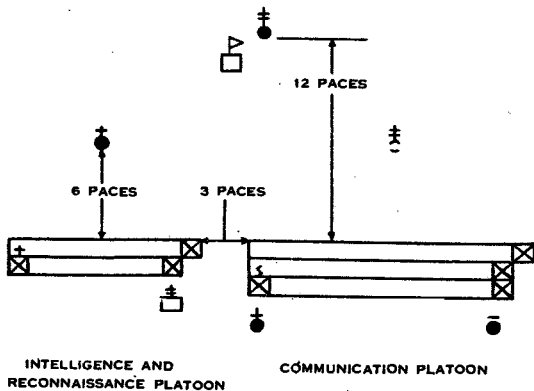

**NOTES:**

1. FOR DISPOSITION OF COMPANY HEADQUARTERS PERSONNEL SEE PAR. 178.
2. FOR DISPOSITION OF COMPANY TRUCKS, SEE PAR. 163 AND 171. PERSONNEL CONCERNED WITH THEIR OPERATION AND MAINTENANCE NOT SHOWN.

**LEGEND**

- |  |  |
|--|--|
| <ul style="list-style-type: none"> <li>● COMPANY COMMANDER</li> <li>☞ COMMUNICATION OFFICER</li> <li>⊕ OTHER OFFICER</li> <li>● WARRANT OFFICER</li> <li>☞ FIRST SERGEANT</li> </ul> | <ul style="list-style-type: none"> <li>☒ PLATOON SERGEANT</li> <li>☒ COMMUNICATION CHIEF</li> <li>☒ SERGEANT</li> <li>☐ GUIDON BEARER</li> </ul> |
|--|--|

**FIGURE 47.—Regimental headquarters company in line.**

[A. G. 300.7 (8 Sep 43).] (C 3, 16 Sep 43.)

# BASIC FIELD MANUAL

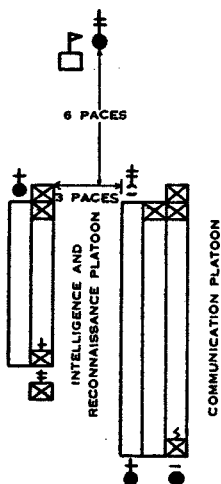

(SEE NOTES, FIGURE 47)

## LEGEND









-  COMPANY COMMANDER
-  COMMUNICATION OFFICER
-  OTHER OFFICER
-  WARRANT OFFICER
-  FIRST SERGEANT
-  PLATOON SERGEANT
-  COMMUNICATION CHIEF
-  SERGEANT
-  GUIDON BEARER

FIGURE 48.—Regimental headquarters company in mass formation.

[A. G. 300.7 (8 Sep 43).] (C 3, 16 Sep 43.)

## INFANTRY DRILL REGULATIONS

■ 188. SIGNALS.—Signals are generally \* \* \* of their movement. (See par. 325.)

[A. G. 300.7 (8 Sep 43).] (C 3, 16 Sep 43.)

■ 189. VEHICLE AND ITS LOAD.—*a.* Units armed with machine guns and mortars carry these weapons in their unit trucks together with ammunition, accessories, and the personnel of the gun squad. Antitank guns and 105-mm howitzers are towed by prime movers; the antitank gun and mine squads, personnel of howitzer sections, ammunition, and accessories are transported on the prime movers and other unit transport.

\* \* \* \* \*

[A. G. 300.7 (8 Sep 43).] (C 3, 16 Sep 43.)

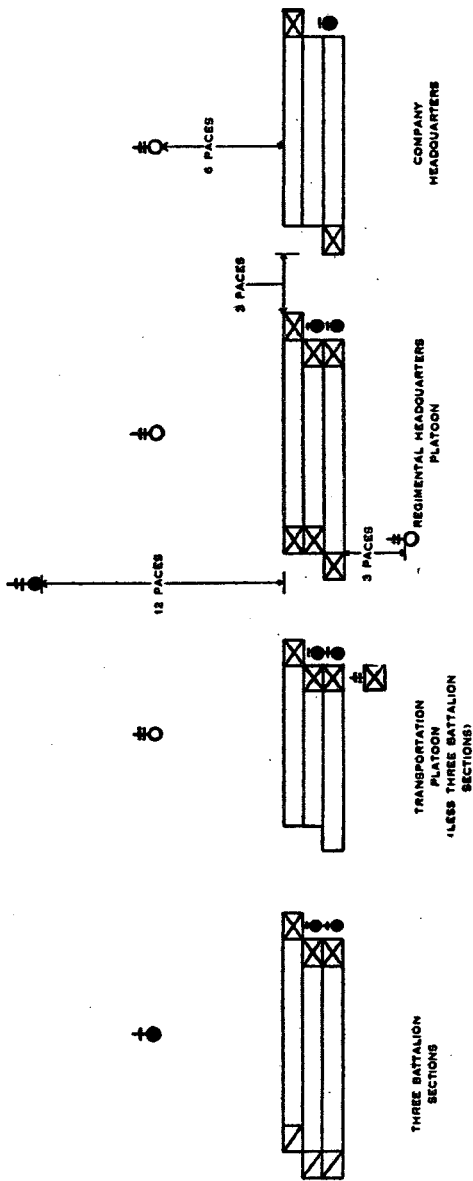

NOTE: DIAGRAM INCLUDES ALL OFFICERS AND MEN OF THE COMPANY.

① In line (dismounted).

FIGURE 56.—Service company.

# INFANTRY DRILL REGULATIONS

## LEGEND







	CAPTAIN COMPANY COMMANDER		FIRST SERGEANT
	OTHER CAPTAINS		SERGEANT
	LIEUTENANT		CORPORAL
	WARRANT OFFICER		

FIGURE 56.—Continued.

# BASIC FIELD MANUAL

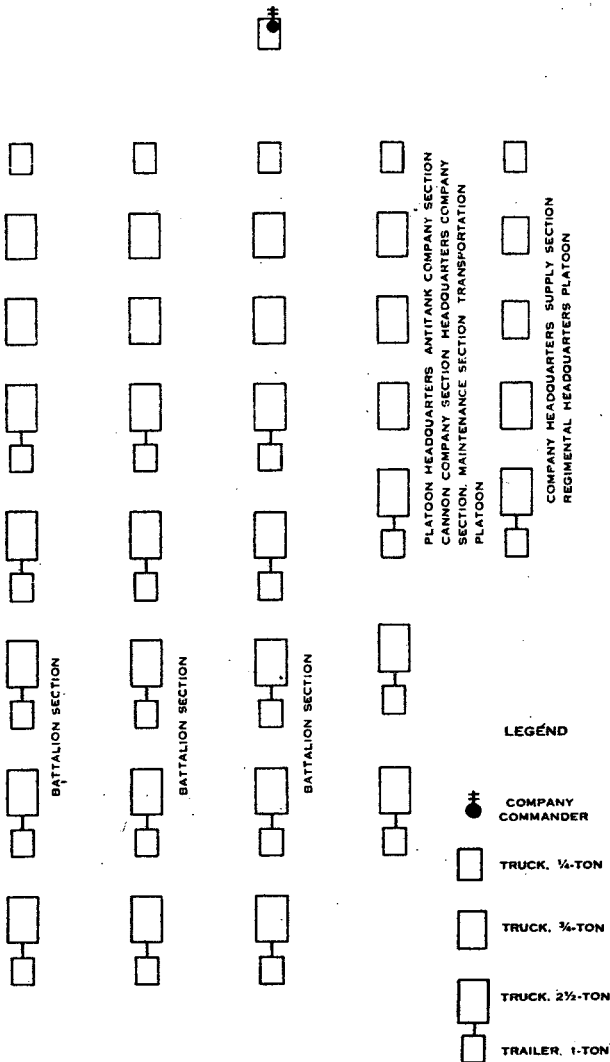

② Motorized elements in mass formation.

FIGURE 56.—Service company—Continued.

[A. G. 300.7 (8 Sep 43).] (C 3, 16 Sep 43.)

# INFANTRY DRILL REGULATIONS

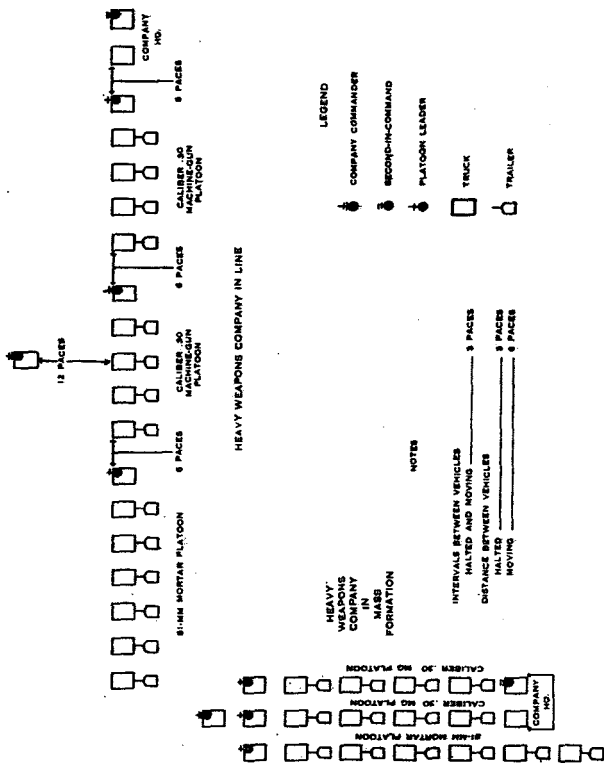

**FIGURE 57.—Heavy weapons company (personnel mounted) in line and in mass formation.**  
 [A. G. 300.7 (8 Sep 43).] (C 8, 16 Sep 43.)



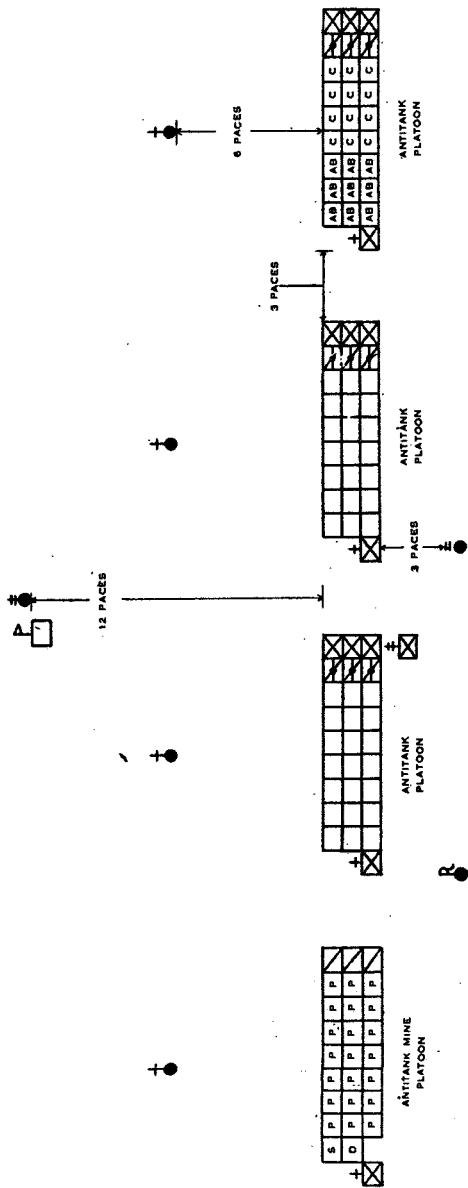

① In line (personnel dismounted).

FIGURE 58.—Antitank company.

LEGEND

‡ ●	COMPANY COMMANDER	☒	CORPORAL GUNNER
≡ ●	SECOND-IN-COMMAND	☐	GUIDON BEARER
R ●	RECONNAISSANCE OFFICER	☐	CANNONEER
† ●	PLATOON LEADER	☐	AMMUNITION BEARER
‡ ☒	FIRST SERGEANT	☐	SURVEYOR
† ☒	PLATOON SERGEANT	☐	DRAFTSMAN, TOPOGRAPHIC
☒	SERGEANT	☐	PIONEER
☒	CORPORAL SQUAD LEADER		

NOTES 1. FOR DISPOSITION OF COMPANY TRANSPORT SEE PARS 163 AND 171

2. FOR DISPOSITION OF COMPANY HEADQUARTERS PERSONNEL SEE PAR 178c

Figure 58.—Continued.

# BASIC FIELD MANUAL

NOTE:  
RIGHT CENTER PLATOON  
IS THE BASE PLATOON.  
(SEE NOTES, FIGURE 57)

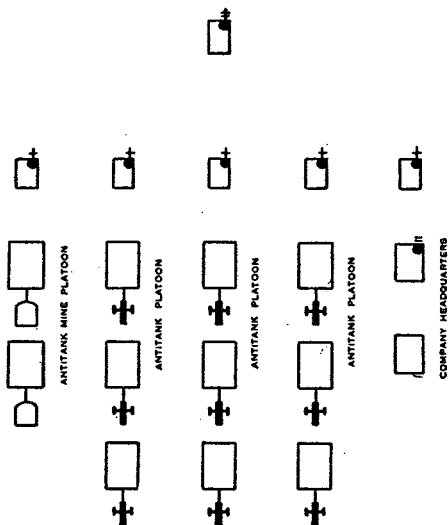

## LEGEND

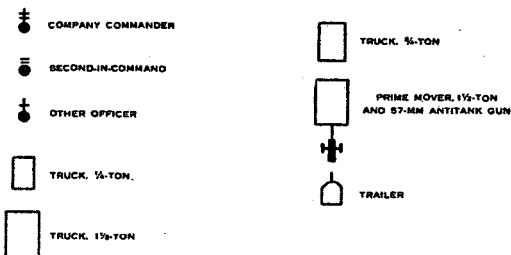

③ In mass formation (personnel mounted).

FIGURE 58.—Antitank company—Continued.

[A. G. 300.7 (8 Sep 43).] (C 3, 16 Sep 43.)



# BASIC FIELD MANUAL

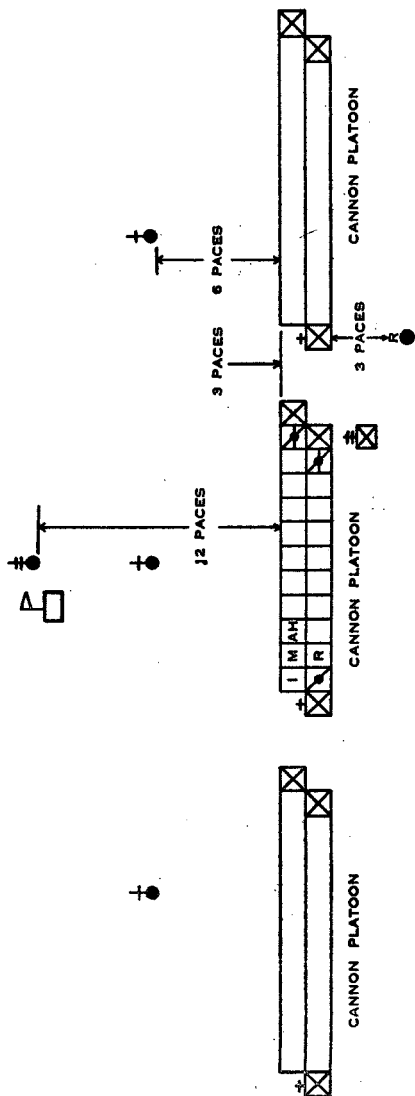

① In line.

FIGURE 58.1.—Cannon company.

# INFANTRY DRILL REGULATIONS

## LEGEND

<p>‡ ● COMPANY COMMANDER</p> <p>R ● RECONNAISSANCE OFFICER</p> <p>† ● OTHER OFFICER</p> <p>‡ ⊠ FIRST SERGEANT</p> <p>† ⊠ PLATOON SERGEANT</p> <p>⊠ SERGEANT, CHIEF OF SECTION</p> <p>⊠ CORPORAL, GUNNER</p>	<p>⊠ CORPORAL, AGENT</p> <p>□ CANNONEER</p> <p>⊠ R OPERATOR, RADIOTELEPHONE</p> <p>⊠ I OPERATOR, INSTRUMENT</p> <p>⊠ AH AMMUNITION HANDLER</p> <p>⊠ GUIDON BEARER</p> <p>⊠ M MECHANIC, ARTILLERY</p>
---	--

**NOTES:**

1. FOR DISPOSITION OF COMPANY HEADQUARTERS PERSONNEL NOT SHOWN IN DIAGRAM, SEE PAR. 178f.
2. PERSONNEL CONCERNED WITH OPERATION AND MAINTENANCE OF TRANSPORT NOT SHOWN.

FIGURE 58.1.—Continued.

# BASIC FIELD MANUAL

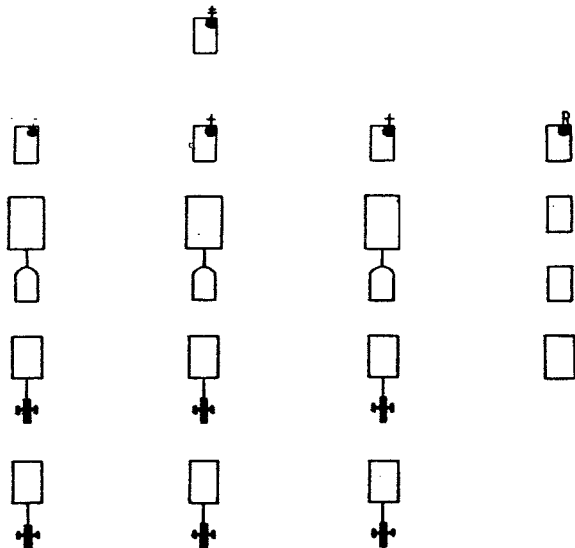

## LEGEND

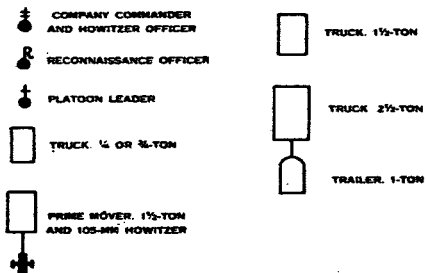

**NOTE**

INTERVALS BETWEEN VEHICLES:  
HALTED AND MOVING \_\_\_\_\_ 3 PACES

DISTANCE BETWEEN VEHICLES:  
HALTED \_\_\_\_\_ 3 PACES  
MOVING \_\_\_\_\_ 6 PACES

③ In mass formation (mounted).

FIGURE 58.1.—Cannon company—Continued.  
[A. G. 300.7 (8 Sep 43).] (C 3, 16 Sep 43.)

## INFANTRY DRILL REGULATIONS

### ■ 214. FORMATIONS.

\* \* \* \*

*f.* Rescinded.

\* \* \* \*

[A. G. 300.7 (8 Sep 43).] (C 3, 16 Sep 43.)



# BASIC FIELD MANUAL

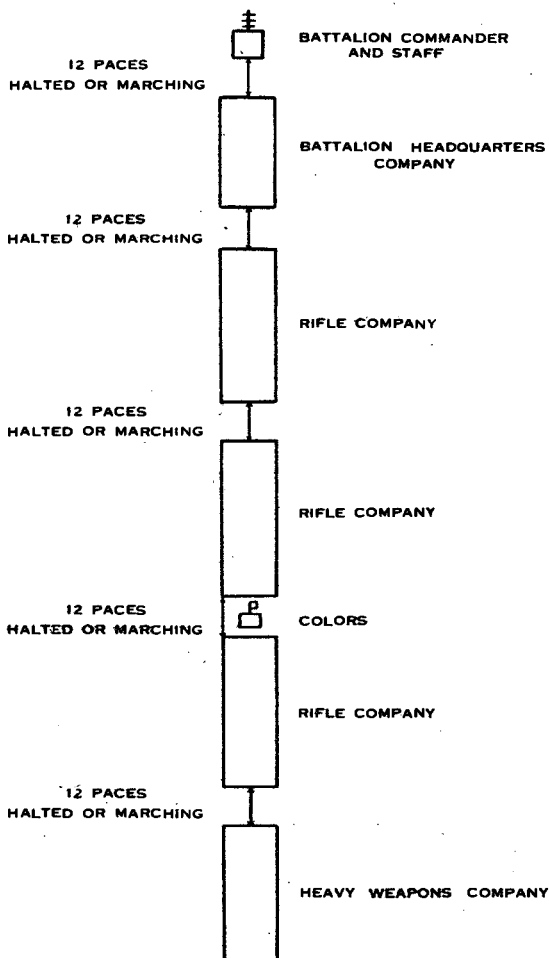



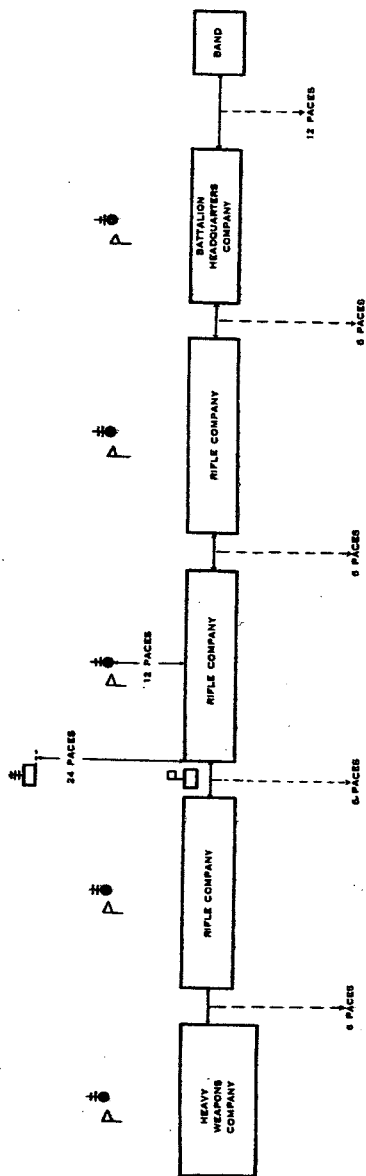

NOTE: FOR DISPOSITION OF MOTOR VEHICLES OF THE BATTALION. SEE PAR. 163 AND 171.

FIGURE 59.—Battalion in column.

[A. G. 300.7 (8 Sep 43).] (C 3, 16 Sep 43.)



LEGEND

-  BATTALION COMMANDER AND STAFF
-  COMPANY COMMANDER
-  COLORS
-  GIBSON

NOTE  
FOR DEPOSITION OF  
MOTOR VEHICLES OF  
THE BATTALION SEE  
PARS 163 AND 171.

FIGURE 60.—Battalion in line with companies in line.  
[A. G. 300.7 (8 Sep 43).] (C 3, 16 Sep 43.)

## BASIC FIELD MANUAL

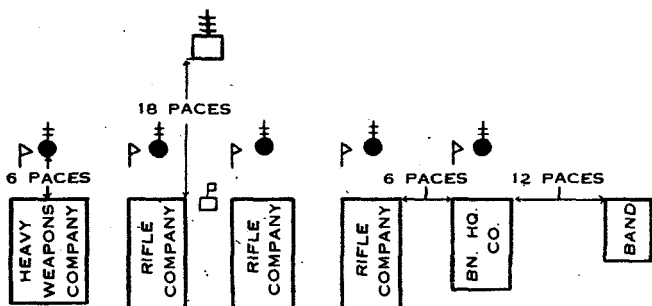

### NOTES:

1. RIFLE COMPANY MAY FORM AND MARCH WITH 3 TO 6 PACES INTERVAL BETWEEN PLATOONS TO MAKE THE MASS APPEAR LARGER.
2. FOR DISPOSITION OF MOTOR VEHICLES OF THE BATTALION. SEE PARS. 163 AND 171

### LEGEND



FIGURE 61.—Battalion in line with companies in mass formation.

[A. G. 300.7 (8 Sep 43).] (C 3, 16 Sep 43.)

# INFANTRY DRILL REGULATIONS

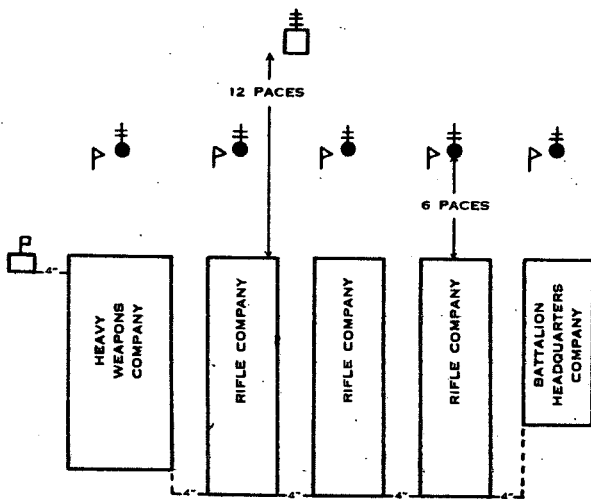

EACH COMPANY IN COLUMN AT CLOSE INTERVAL  
WITHOUT DISTANCE BETWEEN PLATOONS.

COMPANIES FORM ABREAST WITHOUT INTERVAL  
(FOR A WIDER FRONTAGE COMPANIES MAY FORM  
WITH THREE PACES INTERVAL.)

### LEGEND

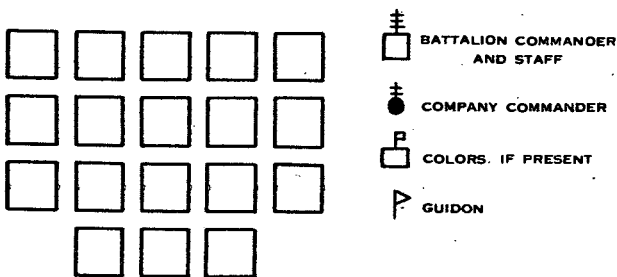

NOTE: FOR DISPOSITION OF MOTOR VEHICLES OF  
THE BATTALION SEE PARS 163 AND 171

FIGURE 62.—Battalion in mass formation.

[A. G. 300.7 (8 Sep 43).] (C 3, 16 Sep 43.)

## BASIC FIELD MANUAL

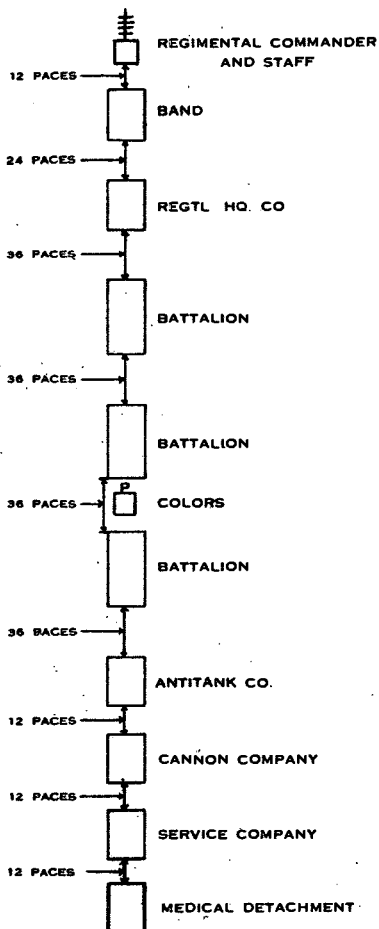

NOTE: FOR DISPOSITION OF MOTOR VEHICLES OF  
THE REGIMENT. SEE PARS. 163 AND 171

FIGURE 63.—Regiment in column (dismounted) with battalions in column of threes and fours. (For formation of battalion heavy weapons companies, see figure 45.)

[A. G. 300.7 (8 Sep 43).] (C 3, 16 Sep 43.)

## INFANTRY DRILL REGULATIONS

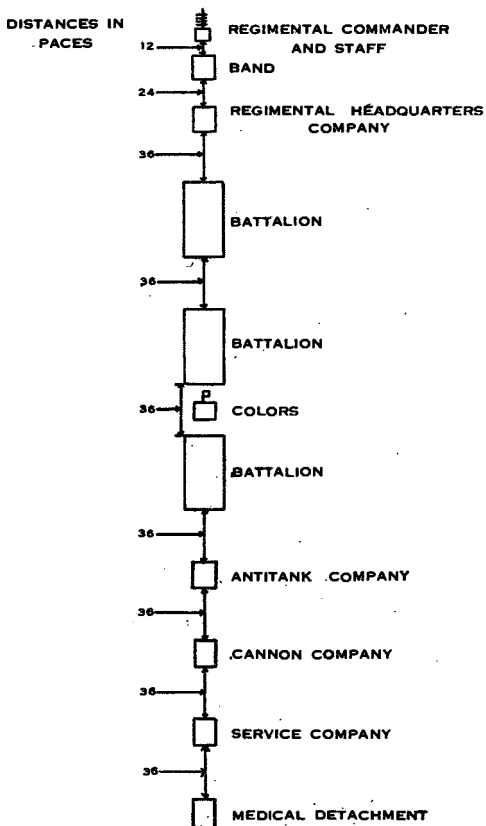

- NOTES:**
1. FOR DISPOSITION OF MOTOR VEHICLES OF THE REGIMENT, SEE PARS. 163 AND 171.
  2. REGIMENTAL HEADQUARTERS COMPANY, ANTITANK COMPANY, CANNON COMPANY, SERVICE COMPANY AND MEDICAL DETACHMENT, MAY BE FORMED INTO A FOURTH BATTALION.

**FIGURE 64.**—Regiment in column (dismounted) with battalions in mass formation.

[A. G. 300.7 (8 Sep '43).] (C 3, 16 Sep 43.)

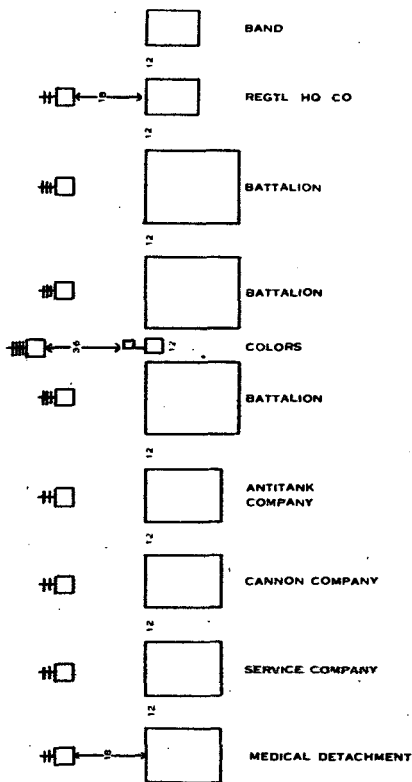

LEGEND

 REGIMENTAL COMMANDER AND STAFF

 COMPANY OR DETACHMENT COMMANDER

 BATTALION COMMANDER AND STAFF

 COLORS

NOTE  
INTERVALS AND  
DISTANCES SHOWN  
IN PAGES

- NOTES: 1. FOR DISPOSITION OF MOTOR VEHICLES OF THE REGIMENT. SEE PARS. 163 AND 171
2. REGIMENTAL HEADQUARTERS COMPANY, ANTITANK COMPANY, CANNON COMPANY, SERVICE COMPANY AND MEDICAL DETACHMENT, MAY BE FORMED INTO A FOURTH BATTALION.



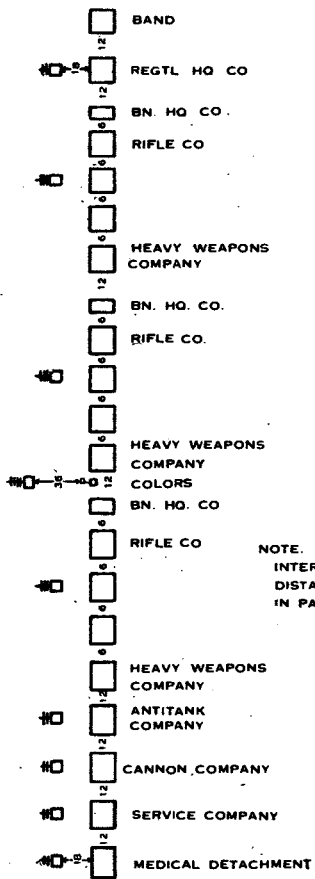

FIGURE 65.—Regiment in line (dismounted) with battalions in mass formation.

[A. G. 300.7 (8 Sep 43).] (C 3, 16 Sep 43.)



NOTE.  
INTERVALS AND  
DISTANCES SHOWN  
IN PACES

LEGEND

- |   |                                |   |                                 |
|---|--------------------------------|---|---------------------------------|
|  | REGIMENTAL COMMANDER AND STAFF |  | COMPANY OR DETACHMENT COMMANDER |
|  | BATTALION COMMANDER AND STAFF  |  | COLORS                          |

NOTE FOR DISPOSITION OF MOTOR VEHICLES OF THE REGIMENT. SEE PARS 163 AND 171

FIGURE 66.—Regiment in line (dismounted) with companies in mass formation.



## BASIC FIELD MANUAL

■ 258. **DISPOSITIONS.**—Dispositions of the rifle squad are—  
Squad column.

As skirmishers.

**Diamond formation.**

*a. Squad column* (fig. 70).—At the signal or command **Squad Column**, given when the squad is disposed in any manner, its

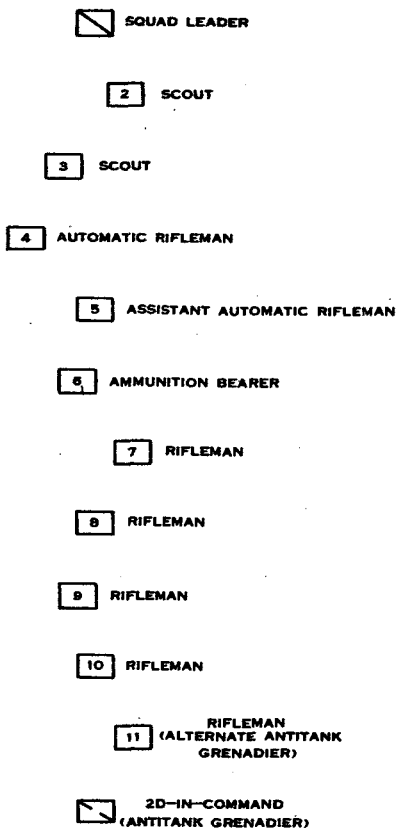

FIGURE 70.—Squad column (closed) (distance between men approximately 5 paces).

[A. G. 300.7 (8 Sep 43).] (C 3, 16 Sep 43.)

## INFANTRY DRILL REGULATIONS

members form in an irregular column behind the squad leader. With scouts out, the squad forms in a similar manner. The disposition of individuals in the column will be adapted to the terrain and circumstances and may vary from a widely spaced and staggered column suitable for crossing very open country (fig. 71) to a column of files closed up behind the leader.

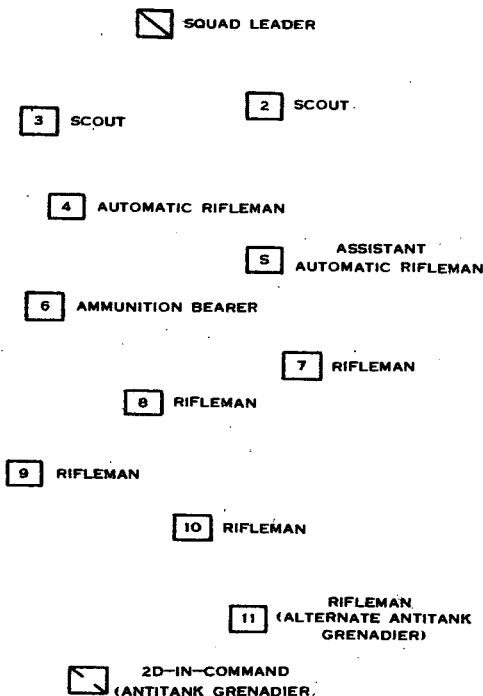

FIGURE 71.—Squad column (opened) (distance between men approximately 5 paces; width approximately 20 paces).

[A. G. 300.7 (8 Sep 43).] (C 3, 16 Sep 43.)

*b. As skirmishers* (fig. 72).—(1) At the signal or command **As Skirmishers**, usually given from squad column but permissible from any disposition, the squad deploys as shown in figure 72. Nos. 7 and 8 (riflemen) go to the right; Nos. 9 and

BASIC FIELD MANUAL

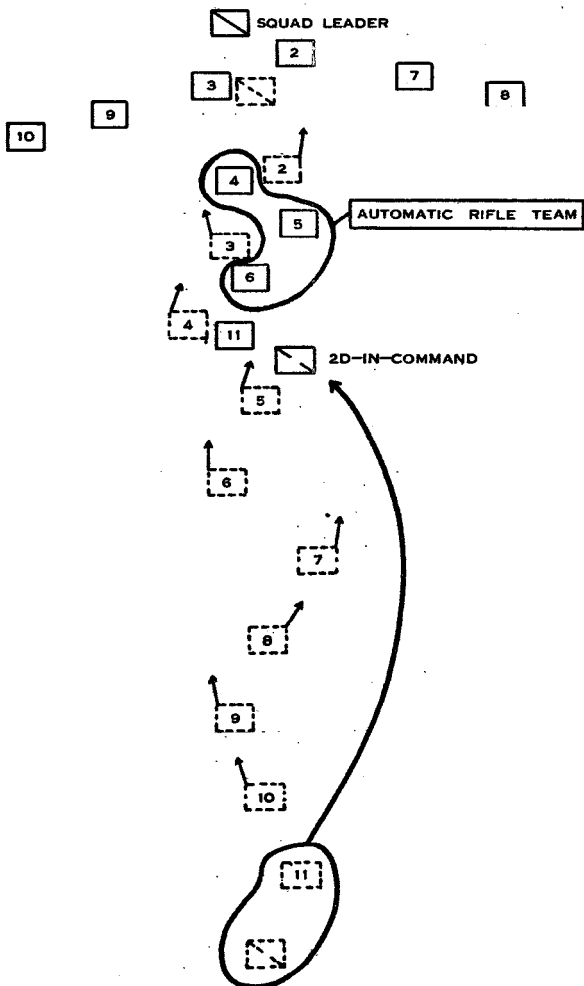

FIGURE 72.—As skirmishers from squad column (interval between individual men approximately 5 paces; between pairs, variable depending on the nature of the terrain being traversed).

[A. G. 300.7 (8 Sep 43).] (C 3, 16 Sep 43.)

## INFANTRY DRILL REGULATIONS

10 (riflemen) go to the left; No. 4 (automatic rifleman), No. 5 (assistant automatic rifleman), and No. 6 (ammunition bearer), close to a central location in rear of the squad, prepared to move to the front or to either flank as signaled or ordered by the squad leader. No. 11 (rifleman) and No. 12 (second-in-command) close on the automatic rifle team, preserving a distance of approximately 5 paces between themselves. However, No. 11 may be employed anywhere on the firing line by the squad leader.

(2) (Added.) The squad leader is in front of his squad when it is advancing; when it halts to fire, he drops back behind the line to a position from which he can control his squad and observe to the front.

c. Rescinded.

d. Rescinded.

c. (Added.) *Diamond formation* (fig. 74).—(1) At the signal or command **DIAMOND FORMATION**, usually given from squad column but permissible from any disposition, the men dispose themselves in a diamond formation around the squad leader as shown in figures 74 ① and ②. The scouts, forming the leading pair, move out to the front; Nos. 7 and 8 (riflemen) move out to the right flank as a pair; Nos. 9 and 10 (riflemen) move out to the left bank as a pair; No. 4 (automatic rifleman), No. 5 (assistant automatic rifleman), and No. 6 (ammunition bearer), close to a central location in rear of the squad leader, and move as directed by him. No. 11 (rifleman) and No. 12 (second-in-command) move up to the position vacated by Nos. 7 and 8 and become the rear pair. For drill, the interval between individual men is approximately 5 paces, and the leading and flank pairs are from 7 to 10 paces from the squad leader. In combat, the distance the scouts will precede the squad and the interval between the pairs on the flanks will depend upon the terrain. Visual contact must be maintained with the squad leader at all times.

(2) For illustration of "as skirmishers" from the diamond formation, see figure 74③.

[A. G. 300.7 (8 Sep 43).] (C 3, 16 Sep 43.)

Figure 73, Skirmishers right (or left), page 166, is rescinded.

[A. G. 300.7 (8 Sep 43).] (C 3, 16 Sep 43.)

BASIC FIELD MANUAL

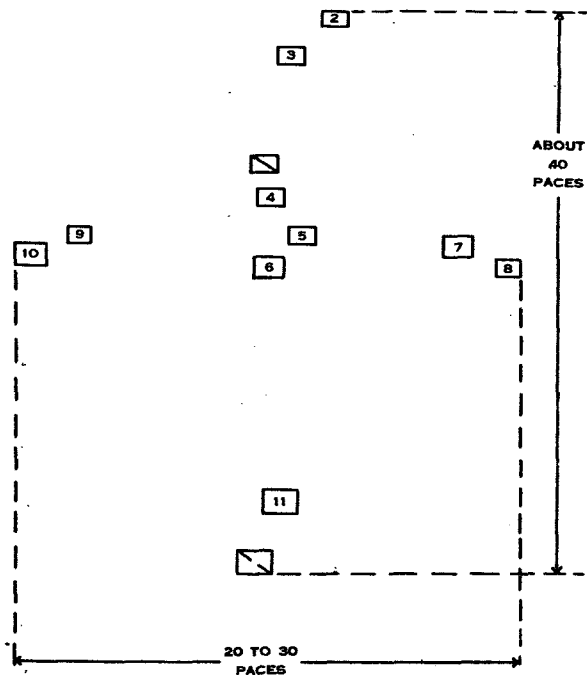

- ① Squad in diamond formation. (Distance between individual men approximately 5 paces; between pairs, variable depending on the nature of the terrain being traversed.)

FIGURE 74.—Diamond formation.

INFANTRY DRILL REGULATIONS

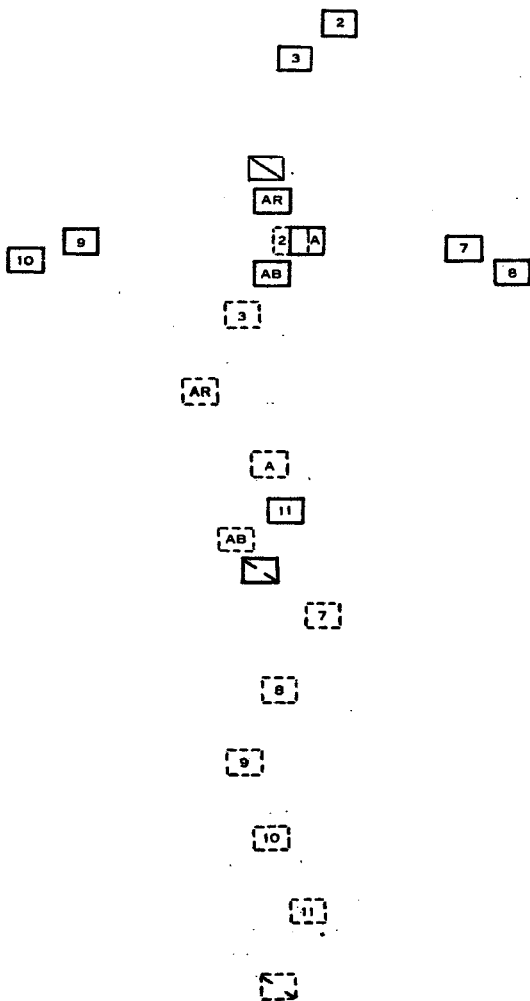

③ Diamond from squad column.

FIGURE 74.—Diamond formation—Continued.

BASIC FIELD MANUAL

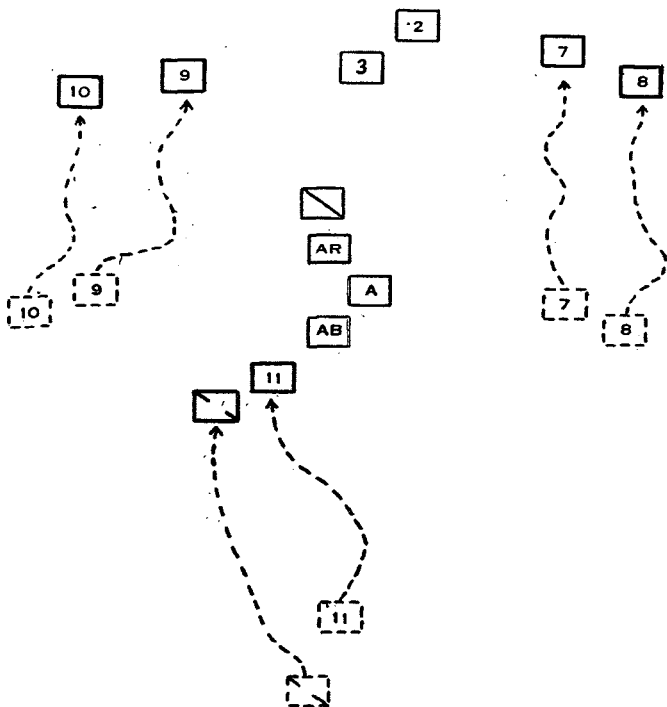

⑧ Skirmishers from diamond formation. (Interval between individual men approximately 5 paces; between pairs, variable depending on the nature of the terrain being traversed.)

FIGURE 74.—Diamond formation—Continued.

[A. G. 300.7 (8 Sep 43).] (C 3, 16 Sep 43.)

Section III, Automatic Rifle Squad, is rescinded.

[A. G. 300.7 (8 Sep 43).] (C 3, 16 Sep 43.)

■ 269. BASE SQUAD.—a

\* \* \* \* \*

(3) (Added.) When in column of twos, the right leading squad is the base squad.

\* \* \* \* \*

[A. G. 300.7 (8 Sep 43).] (C 3, 16 Sep 43.)

## INFANTRY DRILL REGULATIONS

Figure 75, Automatic rifle squad column (closed), page 170, is rescinded.

[A. G. 300.7 (8 Sep 43).] (C 3, 16 Sep 43.)

Figure 76, Automatic rifle squad column (opened), page 171, is rescinded.

[A. G. 300.7 (8 Sep 43).] (C 3, 16 Sep 43.)

Figure 77, Automatic rifle squad as skirmishers, page 172, is rescinded.

[A. G. 300.7 (8 Sep 43).] (C 3, 16 Sep 43.)

Figure 78, Automatic rifle squad as skirmishers right (left) page 173, is rescinded.

[A. G. 300.7 (8 Sep 43).] (C 3, 16 Sep 43.)

Figure 79, Automatic rifle squad wedge, page 174, is rescinded.

[A. G. 300.7 (8 Sep 43).] (C 3, 16 Sep 43.)

### ■ 270. DISPOSITIONS.—*a.*

\* \* \* \* \*

(5) One squad forward, two squads back (fig. 80).

(6) Two squads forward, one squad back (fig. 80).

(7) (Added.) A formation with squads echeloned to the right or left rear may be used to protect an exposed flank and to permit maximum fire to be delivered promptly toward that flank.

*b.* When the platoon is deployed, each squad may be in squad column, diamond formation, or as skirmishers.

[A. G. 300.7 (8 Sep 43).] (C 3, 16 Sep 43.)

■ 271. FRONTAGE.—The platoon deploys with sufficient intervals between squads to permit minor maneuvers of squads. Unless otherwise directed, squad columns, or squads disposed in the diamond formation keep about 50 yards apart. When deployed as \* \* \* unless otherwise directed.

[A. G. 300.7 (8 Sep 43).] (C 3, 16 Sep 43.)

■ 273. PLATOON COLUMN.—Being in any formation, at the signal or command **Platoon Column**, the base squad (see par.



## BASIC FIELD MANUAL

269) moves out in squad column, followed in turn by the remaining squads or as prescribed by the platoon leader.

[A. G. 300.7 (8 Sep 43).] (C 3, 16 Sep 43.)

■ 274. **DEPLOY Platoon INTO SQUAD COLUMNS.**—*a. In line of squad columns.*—The command is: **LINE OF SQUAD COLUMNS 50 (or other) PACES.**

(1) (Added.) *Being in column of twos.*—At the command **LINE OF SQUAD COLUMNS 50 PACES**, the base squad moves in squad column to the front or in the direction indicated by the platoon leader. The squad on the left of the base squad moves in squad column to a position approximately 50 paces to the left of the base squad. The rear squad moves in squad column to a position approximately 50 paces to the right of the base squad.

(2) (Added.) *Being in column of threes.*—At the command **LINE OF SQUAD COLUMNS 50 PACES**, the base squad moves in squad column to the front, or in the direction indicated by the platoon leader. The right and left squads move in squad column to positions approximately 50 paces to the right and left respectively of the base squad.

(3) (Added.) *Being in platoon column.*—At the command **LINE OF SQUAD COLUMNS 50 PACES**, the base squad moves in squad column to the front, or in the direction indicated by the platoon leader. The second and third squads in column move in squad column to positions approximately 50 paces to the right and left, respectively, of the base squad.

*b. In squad columns with one squad forward.*—At the command **SQUAD COLUMNS**, the base (or designated) squad moves in squad column to the front or in the direction indicated by the platoon leader; the other two squads move in squad column to the right and left until about 50 paces apart and follow the base or leading squad at about 50 paces. If the base squad is halted by the platoon leader, the other two squads move to the rear if necessary to gain their positions (fig. 80).

*c. In squad columns with one squad back.*—At the command **SQUAD COLUMNS, CENTER (OR DESIGNATED) SQUAD BACK**, the other two squads move in squad column to the right and left so as to march in the direction indicated by the platoon leader with about 50 paces interval. The center (or designated) squad follows the leading squads in squad column at about

# INFANTRY DRILL REGULATIONS

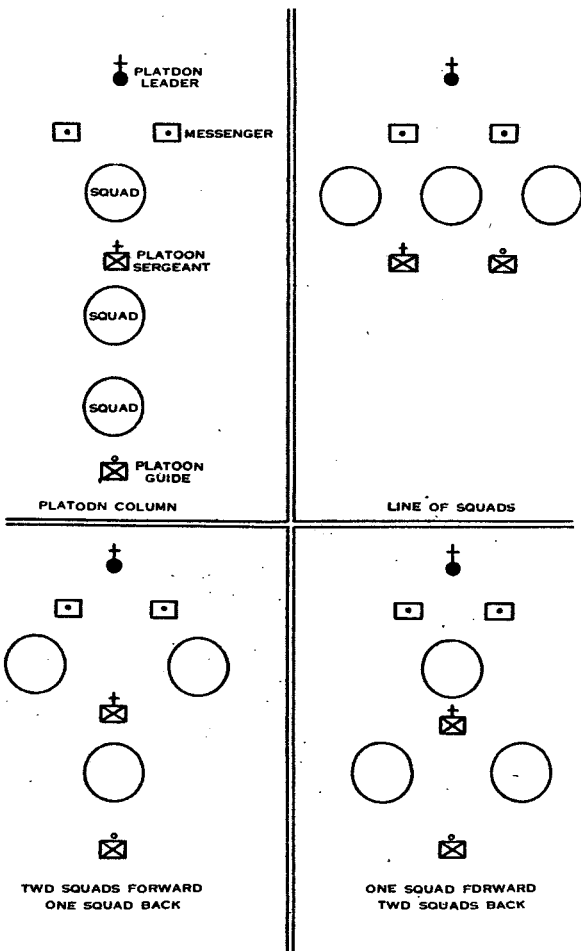

NOTE: THE POSITION OF THE PLATOON SERGEANT IS NOT FIXED. HE MOVES AS DIRECTED BY THE PLATOON LEADER.

FIGURE 80.—Disposition for the platoon.

[A. G. 300.7 (8 Sep 43).] (C 3, 16 Sep 43.)

## BASIC FIELD MANUAL

50 paces. If the leading squads are halted by the platoon leader, the center (or designated) squad moves to the rear if necessary to gain its position (fig. 80).

*d.* From column of threes, the center squad is usually designated as the forward or rear squad. In other dispositions, the squad most conveniently located may be designated.

[A. G. 300.7 (8 Sep 43).] (C 3, 16 Sep 43.)

### ■ 275. DEPLOY PLATOON AS SKIRMISHERS.

\* \* \* \* \*

*b.* To deploy as skirmishers with one squad forward (or back) the command is: AS SKIRMISHERS, BASE (or DESIGNATED) SQUAD FORWARD (or BACK). The squads move \* \* \* reach their positions.

[A. G. 300.7 (8 Sep 43).] (C 3, 16 Sep 43.)

■ 277. ASSEMBLE PLATOON.—To assemble the \* \* \* is to be made. The platoon assembles in column of threes or twos.

[A. G. 300.7 (8 Sep 43).] (C 3, 16 Sep 43.)

■ 279. ANTI-AIRCRAFT DEPLOYMENT.—*a.* Being in column \* \* \* in like manner. The men of the center squad take interval between the right and left squads, even-numbered men to the right and odd-numbered men to the left. The automatic riflemen are deployed as directed by the squad leaders, unless otherwise specified by the platoon leader (fig. 81).

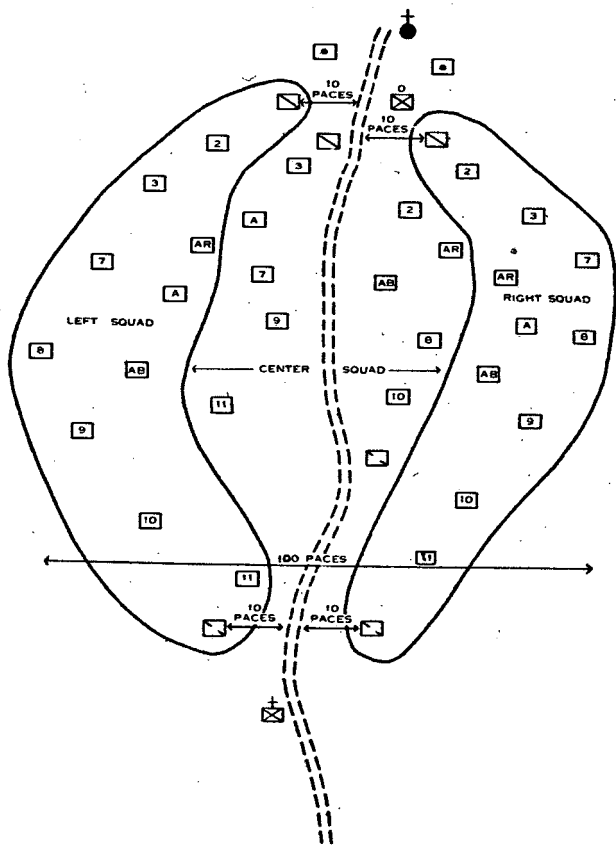

LEGEND





- |  |                  |   |                              |
|--|------------------|---|------------------------------|
|  | PLATOON LEADER   |  | RIFLEMAN                     |
|  | PLATOON SERGEANT |  | AUTOMATIC RIFLEMAN           |
|  | PLATOON GUIDE    |  | ASSISTANT AUTOMATIC RIFLEMAN |
|  | SQUAD LEADER     |  | AMMUNITION BEARER            |
|  | 2D-IN-COMMAND    |   |                              |
|  | MESSANGER        |   |                              |

FIGURE 81.—Platoon antiaircraft deployment.

[A. G. 300.7 (8 Sep 43).] (C 3, 16 Sep 43.)

## BASIC FIELD MANUAL

\* \* \* \* \*

d. Rescinded.

\* \* \* \* \*

[A. G. 300.7 (8 Sep 43).] (C 3, 16 Sep 43.)

■ 281. USE OF SCOUTS.—When necessary, the platoon leader has the platoon scouts precede the unit. No more scout pairs than are necessary to cover the front of the platoon will be used.

■ 283. SQUAD.—*a. General.*—Weapons squads represent \* \* \* an irregular column. When desired, a formation similar to that of adjacent units may be prescribed. See figures 82.1 and 82.2 for extended order formation of weapons squads. Specific instructions for \* \* \* unless otherwise directed.

\* \* \* \* \*

[A. G. 300.7 (8 Sep 43).] (C 3, 16 Sep 43.)

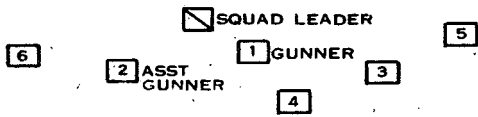

NOTE: WEAPONS SQUADS OF RIFLE COMPANY  
MAY EMPLOY SIMILAR FORMATIONS

FIGURE 82.1.—Heavy weapons squad as skirmishers.

[A. G. 300.7 (8 Sep 43).] (C 3, 16 Sep 43.)

# INFANTRY DRILL REGULATIONS

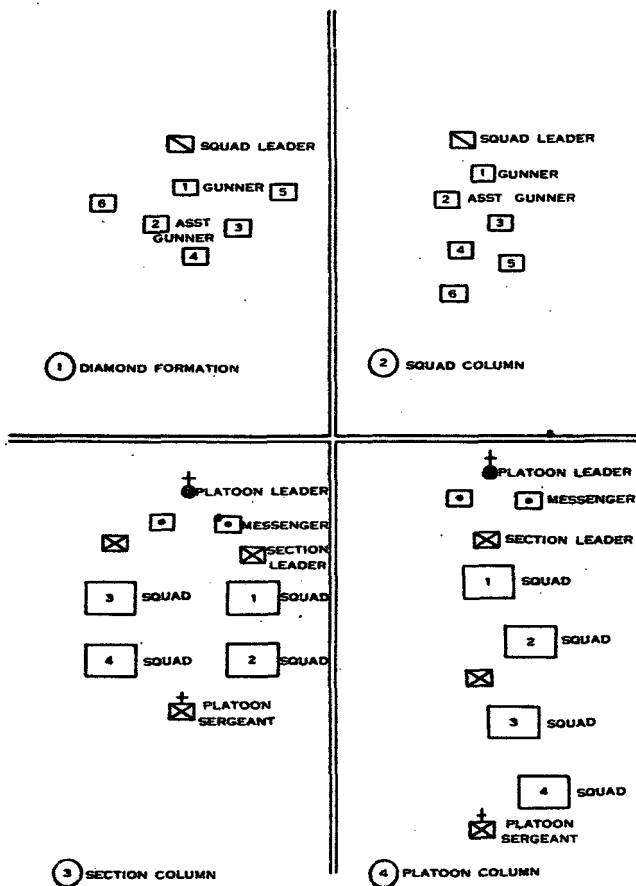

NOTE: WEAPONS PLATOON OF RIFLE COMPANY  
MAY EMPLOY SIMILAR FORMATIONS

FIGURE 82.2.—Formations of heavy weapons squad and platoon.

[A. G. 300.7 (8 Sep 43).] (C 3, 16 Sep 43.)

■ 285. PLATOON.

\* \* \* \* \*

*d. Duties of instrument corporal.*—When the platoon is deployed the messengers are formed as a group under command of the instrument corporal. The instrument corporal conducts this group at the head of the platoon, unless otherwise directed, conforming to the disposition of its other elements.

*e. Dispositions.*—The platoon deploys in the same manner as the squad or section. The platoon may be disposed in platoon column, line of sections, or antiaircraft deployment. The disposition, intervals, \* \* \* under available cover.

\* \* \* \* \*

[A. G. 300.7 (8 Sep 43).] (C 3, 16 Sep 43.)

■ 299.1. (Added.) ENEMY TANKS IN SIGHT.—With the fist strike the rifle or carbine several times between the upper sling swivel and the front sight.

[A. G. 300.7 (8 Sep 43).] (C 3, 16 Sep 43.)

■ 301. AS SKIRMISHERS, RIGHT (LEFT).—Rescinded.

[A. G. 300.7 (8 Sep 43).] (C 3, 16 Sep 43.)

■ 314. WEDGE FORMATION.—Rescinded.

[A. G. 300.7 (8 Sep 43).] (C 3, 16 Sep 43.)

Figure 87, General arm and hand signals, page 192, is rescinded.

[A. G. 300.7 (8 Sep 43).] (C 3, 16 Sep 43.)

■ 314.1. (Added.) DIAMOND FORMATION.—Face the unit, place hands behind head, elbows extended beyond the shoulders.

[A. G. 300.7 (8 Sep 43).] (C 3, 16 Sep 43.)

■ 314.2. (Added.) SQUAD OR SECTION COLUMN.—Face the unit, raise the right arm to the front, until horizontal, palm of hand down: first give the signal for squad or section (fig. 87), then smartly lower and raise the right arm to the side of the leg several times.

[A. G. 300.7 (8 Sep 43).] (C 3, 16 Sep 43.)

■ 314.3 (Added.) PLATOON COLUMN.—Face the unit, raise both arms to the front, until horizontal, palm of hands down: first give the signal for platoon (fig. 87), then smartly lower and raise both arms to the sides of the legs several times.

[A. G. 300.7 (8 Sep 43).] (C 3, 16 Sep 43.)

## INFANTRY DRILL REGULATIONS

■ 323.1 (Added.) **SEARCH.**—Face the unit, with the open hand in front of the body, waist high, palm inward; move the hand upward and downward several times with a chopping motion and then extend hand and arm in the direction of the target.

[A. G. 300.7 (8 Sep 43).] (C 3, 16 Sep 43.)

■ 325. (Superseded.) (As superseded by C 2. **STANDARD SIGNALS.**—*a.* Before a driver changes direction, slows the speed of his vehicle materially, or stops, he should give the appropriate arm-and-hand signal to warn other drivers of the contemplated change. Arm-and-hand signals should be clearly and definitely made. They should be given in time to afford ample warning and last long enough for them to be seen by other drivers. •

*b.* The following arm-and-hand signals are prescribed (see TM 10-460) :

(1) *Attention.*—Extend the arm full length above the head, palm to the front, and move it a few inches slowly from side to side several times.

(2) *Forward march.*—Raise the arm vertically, palm to the front, and lower it to horizontal position in the direction of march.

(3) *Assemble.*—Extend the arm vertically, palm to the front, fingers extended and joined, and move it to describe large horizontal circles slowly about the head.

(4) *Right turn.*—Extend the left arm at the side at an angle of 45° below the horizontal.

(5) *Left turn.*—Extend the left arm straight out.

(6) *Slow or stop.*—Extend the left arm at the side at an angle of 45° below the horizontal.

(7) *Start engines.*—Simulate cranking by describing circles in front of the body with right arm, fist closed.

(8) *Report when ready to start.*—Extend the arm vertically, fingers extended and joined.

(9) *Ready to start.*—Face the leader, and extend the arm vertically, fingers extended and joined, palm toward the leader.

(10) *Stop engines.*—Cross arms in front of body at waist and move them sharply to sides. Repeat several times.

(11) *Increase speed.*—Carry closed fist to the shoulder and rapidly thrust it upward several times to the full extent of the arm.

(12) *Mount.*—Extend the arm horizontally at the side, palm up, and wave it upward several times.



## BASIC FIELD MANUAL

(13) *Dismount*.—Extend the arm horizontally at the side, palm down, and wave it downward.

(14) *Close up*.—Extend the left arm horizontally at the side, palm toward the front, and describe a 2-foot circle.

(15) *Open up*.—Extend the left arm horizontally at the side, palm toward the front, and describe a 90° arc downward several times.

(16) *Pass and keep going*.—Extend the left arm horizontally at the side and move the hand to describe small circles toward the front.

(17) *Immediate danger (air or mechanized attack)*.—Use three long blasts of a whistle, vehicle horn, siren, or klaxon, repeated several times; or three equally spaced shots with rifle, carbine, or pistol; or three short bursts of fire from machine or submachine gun. In daylight, point in the direction of the impending danger; at night, supplement the alarm by voice warning to indicate the direction of danger.

(18) *Turn around simultaneously*.—(a) *Mounted*.—Extend the arm downward at a 45° angle, palm toward the front, and describe small circles with the arm.

(b) *Dismounted*.—Extend both arms horizontally toward the drivers and describe small vertical circles, then signal "Forward March" in the desired new direction.

c. Whenever a march column is halted on a curve, on the downgrade of a hill, or wherever some drivers cannot see the signals, signals may be relayed along the column or transmitted by messengers to all concerned.

d. In addition to the prescribed arm-and-hand signals, electrical and mechanical signals should be used when vehicles are so equipped.

[A. G. 300.7 (8 Sep 43).] (C 3, 16 Sep 43.)

### ■ 326. DRIVER SIGNALS.—Rescinded.

[A. G. 300.7 (8 Sep 43).] (C 3, 16 Sep 43.)

BY ORDER OF THE SECRETARY OF WAR:

G. C. MARSHALL,

*Chief of Staff.*

OFFICIAL:

J. A. ULIO,

*Major General,*

*The Adjutant General.*

U. S. Army Military History Institute

FM 22-5

BASIC FIELD MANUAL



INFANTRY DRILL REGULATIONS

---

Prepared under direction of the  
Chief of Infantry



UNITED STATES  
GOVERNMENT PRINTING OFFICE  
WASHINGTON : 1941

---

For sale by the Superintendent of Documents, Washington, D. C. - Price 30 cents

WAR DEPARTMENT,  
WASHINGTON, August 4, 1941.

FM 22-5, Basic Field Manual, Infantry Drill Regulations, is published for the information and guidance of all concerned.

[A. G. 062.11 (2-17-41).]

BY ORDER OF THE SECRETARY OF WAR:

G. C. MARSHALL,  
*Chief of Staff.*

OFFICIAL:

E. S. ADAMS,  
*Major General,*  
*The Adjutant General.*

DISTRIBUTION:

Bn and H (5); C (20).  
(For explanation of symbols see FM 21-6.)

## TABLE OF CONTENTS

	Paragraph	Page
CHAPTER 1. GENERAL.....	1-13	1
CHAPTER 2. THE SOLDIER WITHOUT ARMS.		
Section I. General.....	14-15	9
II. Positions.....	16-20	10
III. Steps and marchings.....	21-32	13
CHAPTER 3. THE SOLDIER WITH ARMS.		
Section I. General.....	33-34	16
II. Manual of arms for rifle.....	35-58	18
III. Loading and firing.....	59-64	30
IV. Carrying automatic rifle.....	65	35
V. Manual of the pistol.....	66-82	36
VI. Manual of the guidon.....	83-94	41
VII. Manual of the color and stand- ard.....	95-103	45
VIII. Manual of the saber.....	104-113	49
CHAPTER 4. DRILL FOR FOOT TROOPS.		
Section I. Squad.....	114-130	56
II. Platoon.....	131-146	68
III. Company.....	147-158	76
CHAPTER 5. DRILL FOR UNITS WITH ANIMAL-DRAWN CARTS OR PACK ANIMALS.....	159-161	85
CHAPTER 6. DRILL FOR UNITS WITH MOTOR CAR- RIERS.		
Section I. General.....	162-164	87
II. Squad and section.....	165-169	89
III. Platoon.....	170-177	89
IV. Company.....	178-186	93
CHAPTER 7. DRILL FOR MOTOR AND WAGON UNITS.		
Section I. General.....	187-188	101
II. Single vehicle.....	189-194	102
III. Drill for vehicles in single col- umn or line.....	195-200	104
IV. Drill for vehicles in mass forma- tion.....	201-205	108
V. Company drill.....	206-210	114
CHAPTER 8. FORMATIONS OF BATTALION AND REGI- MENT.		
Section I. General.....	211-213	118
II. Battalion.....	214-217	120
III. Regiment.....	218-225	126
CHAPTER 9. CEREMONIES.		
Section I. Reviews and presentation of decorations.....	226-234	132
II. Escorts.....	235-236	144
III. Parades.....	237-238	146
IV. Inspections.....	239-242	147
V. Funerals.....	243-254	151

TABLE OF CONTENTS

	Paragraph	Page
CHAPTER 10. EXTENDED ORDER.		
Section I. General.....	255-256	160
II. Rifle squad.....	257-263	162
III. Automatic rifle squad.....	264-266	169
IV. Rifle platoon.....	267-281	169
V. Company.....	282	180
VI. Weapons squads, sections, and platoons.....	283-285	180
CHAPTER 11. SIGNALS.		
Section I. General.....	286-287	186
II. Whistle signals.....	288-291	187
III. General arm and hand signals..	292-314	187
IV. Additional arm and hand signals for weapons units.....	315-323	192
V. Arm and hand signals for motor vehicles.....	324-326	194
APPENDIX. Special ceremonial parade.....		196
INDEX .....		201

# BASIC FIELD MANUAL

## INFANTRY DRILL REGULATIONS

(This manual supersedes FM 22-5, July 1, 1939, including section II, Training Circular No. 21, War Department, 1941.)

### CHAPTER 1

#### GENERAL

■ 1. SCOPE.—*a.* The drill prescribed herein is designed for general use and may be adapted to any type of unit; therefore some of the explanation is of a general nature which gives sufficient latitude for adaptation to specific units. Interpretation should be based on these general provisions, and all should learn to use this manual as a guide to a common-sense solution of minor points which are not specifically covered in the text. Much discussion over trifles or failure to make appropriate adaptation indicates a failure to grasp the spirit of the regulations. Higher commanders should encourage subordinates to make minor adjustments without calling on higher authority for interpretation. Necessary adaptation should be simple and should not complicate the drill. Stress should be placed on precision in execution of the manual of arms and in marching in step with proper alinement. Nothing inspires the military spirit more than to see or to be a part of a compact group moving in unison, confidently and to a measured cadence. Complicated procedure destroys this effect.

*b.* Basic strengths of units are governed by appropriate Tables of Organization. The diagrams of organizations shown in the figures herein are based specifically on approved Tables of Organization, war strength. They must be adapted to the actual war or peace strengths of the units concerned. They may be adapted to any type of unit, to changes in Tables of Organization, and to the maneuver space available.

■ 2. PURPOSES OF DRILL.—The purposes of drill are to—

a. Enable a commander to move his command from one place to another in an orderly manner and to provide simple formations from which dispositions for combat may readily be assumed.

b. Aid in disciplinary training by instilling habits of precision and response to the leader's orders.

c. Provide a means, through ceremonies, of enhancing the morale of troops, developing the spirit of cohesion, and giving interesting spectacles to the public.

d. Give junior officers and noncommissioned officers practice in commanding troops.

■ 3. DEFINITIONS.—a. *Alinement*.—A straight line upon which several elements are formed or are to be formed; or the dressing of several elements upon a straight line.

b. *Base*.—The element on which a movement is regulated.

c. *Center*.—The middle point or element of a command.

d. *Column*.—A formation in which the elements are placed one behind another.

e. *Depth*.—The space from head to rear of any formation or of a position, including the leading and rear elements. The depth of a man is assumed to be 12 inches.

f. *Distance*.—Space between elements in the direction of depth. Distance is measured, with respect to dismounted men, from the back of the man in front to the breast of the man in rear; mounted men and animals, from the croup of the animal in front to the head of the animal in rear; vehicles, from the rear part of the vehicle in front to the front part of the vehicle or head of animal hitched thereto (as the case may be) in rear. Distance between troops in formation, whether of men, animals, or vehicles, is measured from the rear rank of the unit in front to the front rank of the unit in rear. Platoon commanders, guides, and others whose position in a formation is at 40 inches distance from a rank are themselves considered as a rank. Otherwise the commander of any unit and those accompanying him are not considered in measuring distance between units. The color and guard are not considered in measuring distance between subdivisions of a unit with which they are posted. The distance between ranks of dismounted men is 40 inches in both line and column. The distance between ranks of

mounted men in close order is 45 inches (1½ paces).

*g. Double time.*—Cadence at the rate of 180 steps per minute.

*h. Element.*—A squad, section, platoon, company, or larger unit, forming a part of a still larger unit.

*i. File.*—A column of men one behind the other.

*j. Flank.*—The right or left of a command in line or in column, or the element on the right or left of the line.

*k. Formation.*—Arrangement of the elements of a command. The placing of all fractions in their order in line, in column, or for battle.

*l. Front.*—The space occupied by an element measured from one flank to the opposite flank. The front of a man is assumed to be 22 inches.

*m. Guide.*—An officer, noncommissioned officer, or private upon whom the command (or elements thereof) regulates its march.

*n. Head.*—The leading element of a column.

*o. Interval.*—Space between individuals or elements of the same line. Interval is measured, with respect to dismounted men, from the shoulder or elbow; mounted men from the knee; animals from the shoulder; vehicles from the hub of the wheel or the track. Between troops in formation, it is measured from the left flank of the unit on the right to the right flank of the unit on the left. The commander of any unit, or of any element thereof, and those accompanying him are not considered in measuring interval between units. The color and guard are not considered in measuring interval between subdivisions of a unit with which they are posted. The normal interval is one arm's length; the close interval is 4 inches. The interval between mounted men is 6 inches.

\*[The interval between vehicles is shown in paragraph 171c.

*p. Left.*—The left extremity or element of a body of troops.

*q. Line.*—A formation in which the different elements are abreast of each other.

*r. Mass formation.*—The formation of a company or any larger unit in which the squads in column are abreast of one another.

*s. Pace.*—A step of 30 inches; the length of the full step in quick time.

*t. Piece.*—The rifle or the automatic rifle.

---

\*All changes in this revision are indicated by brackets in the left margin.



*u. Quick time.*—Cadence at the rate of 120 steps per minute.

*v. Rank.*—A line of men placed side by side.

*w. Right.*—The right extremity or element of a body of troops.

*x. Step.*—The distance measured from heel to heel between the feet of a man walking. The half step and back step are 15 inches. The right step and left step are 12 inches. The steps in quick and double time are 30 and 36 inches, respectively.

■ 4. **PRECISION IN DRILL.**—In order best to accomplish its mission, drill should be frequent and of short duration. Smartness and precision should be required in the execution of every detail.

■ 5. **USE OF RIGHT AND LEFT.**—The explanation of a movement in the text that may be executed toward either flank is generally given for execution toward but one flank. To adapt such a description to execution of the movement toward the opposite flank, it is necessary only to substitute the word “left” for “right” or “right” for “left” as the case requires.

■ 6. **DOUBLE TIME.**—*a.* Any movement not especially excepted may be executed in double time.

*b.* If a unit is at a halt or marching in quick time, and it is desired that a movement be executed in double time, the command **DOUBLE TIME** precedes the command of execution.

■ 7. **REVOKE COMMAND.**—To revoke a command or to begin anew a movement improperly begun from a halt, the command **AS YOU WERE** is given, at which the movement ceases and the former position is resumed.

■ 8. **GENERAL RULES FOR GUIDE.**—*a.* Unless otherwise announced, the guide of a platoon or subdivision of a company in column or line is right.

*b.* To march with the guide other than as prescribed above, or to change the guide, the command **GUIDE RIGHT (LEFT, or CENTER)** is given. The leading man in each file is responsible

for the interval. The guide is responsible for the direction and cadence of march.

c. The announcement of the guide, when made in connection with a movement, follows the command of execution for the movement.

d. In column of subdivisions, the guide of the leading subdivision is charged with the step and direction; the guides in the rear preserve the trace, step, and distance.

■ 9. PARTIAL CHANGES OF DIRECTION.—a. Partial changes of direction may be executed by interpolating in the preparatory command the word "half" as COLUMN HALF RIGHT (LEFT), so as to change direction 45°.

b. Slight changes in direction are effected by the command INCLINE TO THE RIGHT (LEFT). The guide or guiding element moves in the indicated direction and the remainder of the command conforms.

■ 10. NUMBERING UNITS.—For permanent designation of infantry units, platoons within each company and squads within each rifle and heavy weapons platoon are numbered from right to left when in line, and from front to rear when in column. In the weapons platoon of the rifle company, squads are numbered within each weapons section. For drill purposes, the platoon or squad on the right (when in line) or in front (when in column) is referred to as the first unit, other units being designated in numerical order from right to left when in line or from front to rear when in column.

■ 11. POSTS OF OFFICERS, NONCOMMISSIONED OFFICERS, GUIDONS, AND SPECIAL UNITS.—a. The posts of officers, noncommissioned officers, guidons, and special units in the various formations of infantry units are shown in the figures or explained in the text.

b. When changes of formation involve changes of posts, the new post is taken by the most direct route, except where otherwise prescribed, as soon as practicable, after the command of execution for the movement; officers and noncommissioned officers who have prescribed duties in connection with the movement ordered take their new posts when such duties are completed. In executing any movement or facing in alining units, or in moving from one post to another,

officers and noncommissioned officers maintain a military bearing and move with precision.

c. When acting as instructors, officers and noncommissioned officers go wherever their presence is necessary. They rectify mistakes and insure steadiness and promptness in the ranks.

d. In subsequent movements after the initial formation, guidons and special units maintain their relative positions with respect to the flank or end of the command on which they were originally posted.

e. In all formations and movements, a noncommissioned officer commanding a section, platoon, or company carries his rifle as the men do, if he is so armed. He takes the same post as prescribed for an officer in command. When giving commands, making reports, or drilling a unit, his rifle is at the right shoulder, if he is so armed.

■ 12. COMMANDS.—a. Commands are employed in close order drill at attention.

b. In this manual a command is the direction of the commander expressed orally and in prescribed phraseology.

c. Where it is not mentioned who gives the prescribed commands, they will be given by the commander of the unit.

d. There are two kinds of commands:

(1) The preparatory command, such as FORWARD, which indicates the movement that is to be executed.

(2) The command of execution, such as MARCH, HALT, or ARMS, which causes the execution.

e. Preparatory commands are distinguished in this manual by SMALL CAPITALS and those of execution by LARGE CAPITALS.

f. The preparatory command is given at such interval of time before the command of execution as to admit proper understanding and to permit the giving of necessary commands by subordinate leaders; the command of execution is given at the instant the movement is to commence.

g. The tone of the command should be animated, distinct, and of a loudness proportioned to the number of men for whom it is intended. Indifference in giving commands must be avoided, as this leads to laxity in execution. Commands must be given with spirit.

*h.* When giving commands to troops, the commander faces them. When the section or platoon in close order drill or in ceremonies is part of a larger unit, the leader turns his head toward the unit to give commands but does not face about.

*i.* Officers and men fix their attention at the first word of command.

*j.* If all men in the unit are to execute the same movement simultaneously, the subordinate leaders do not repeat commands; otherwise they repeat the command or give the proper new command for the movement of their own unit.

*k.* If at a halt, the commands for movements involving marching, such as 1. COLUMN RIGHT, 2. MARCH, are not prefaced by the command FORWARD.

*l. Instruction by the numbers.*—All movements for the purpose of instruction may be divided into motions and executed in detail. The command of execution determines the prompt execution of the first motion. The other motions, depending on the number, are executed at the commands TWO, THREE, FOUR. To execute the movement in detail, the instructor first cautions, "By the numbers." All movements are then executed in detail, one motion for each count until he cautions, "Without the numbers."

■ 13. MASS COMMANDS.—*a.* Mass commands assist in overcoming diffidence, timidity, and awkwardness. They help to develop confidence, self-reliance, assertiveness, and enthusiasm. They require the individual to rely upon his own initiative and intelligence in order both to give the commands correctly, and to execute properly the movement requested by the command. They develop proficiency by making each individual his own drill instructor, and through their use the benefits of individual instruction may be transmitted to large masses.

*b.* Each individual is required to give the commands as if he alone were giving them to the entire unit. The volume and smash of the combined voices impel each man to extend himself to the limit in performing the movements with snap and precision. Giving the commands in unison results in an early development in coordination and sense of cadence in the individual.

*c.* Each movement should be explained in detail and illustrated before it is attempted by the mass. The necessary

Commands for putting the required movement into operation should be rehearsed, without performing the movement, until the mass has learned to give the command properly. When this has been accomplished, the movement should be performed at the command of the mass.

*d.* The interval between the preparatory command and the command of execution will depend upon the number of men being drilled and their degree of proficiency. Care must be exercised that this interval is not too short.

*e.* Instructors should give their preparatory commands with a rising inflection, lifting the entire unit with an intonation that rouses the men and makes them eager to respond when the command of execution is given. In no other phase of training is the quality of instruction as accurately reflected as in mass commands, because of the natural emulation of the instructor by the soldier.

*f.* (1) Mass commands in drill are usually confined to simple movements, those requiring short preparatory commands and commands of execution, and those which are executed simultaneously by all elements of the unit. No movement which requires a repetition of the preparatory command by subordinate leaders or instructors is applicable to mass commands.

(2) The instructor first describes the exercises to be executed, then gives such instructions as are necessary relative to the movement or its cadence. He then causes the mass to give the necessary command to put it into operation. Examples are—

(a) 1. *Instructor.*—1. CALL THE PLATOON TO ATTENTION, 2. **COMMAND.**

2. *Mass.*—1. PLATOON, 2. ATTENTION.

(b) 1. *Instructor.*—1. FACE THE PLATOON TO THE RIGHT, 2. **COMMAND.**

2. *Mass.*—1. RIGHT, 2. FACE.

(c) 1. *Instructor.*—1. GIVE THE PLATOON "AT EASE," 2. **COMMAND.**

2. *Mass.*—AT EASE.

(d) 1. *Instructor.*—1. HAVE THE PLATOON STAND AT PARADE **REST,** 2. **COMMAND.**

2. *Mass.*—1. PARADE, 2. REST.

(e) 1. *Instructor.*—1. HALT THE PLATOON, 2. **COMMAND.**

2. *Mass.*—1. PLATOON, 2. HALT.

[(f) 1. *Instructor*.—1. MARCH THE PLATOON (SQUAD) FORWARD  
[8 PACES, AND HALT, 2. COMMAND.

[2. *Mass*.—1. FORWARD, 2. MARCH, *one, two, three,*  
[*four,* 3. PLATOON, 4. HALT, *one, two.*

[(3) Continuous movements may be conducted as follows:

[(a) *Instructor*.—All movements until further notice will  
[be at your command.

[(b) 1. *Instructor*.—1. FORWARD MARCH, 2. COMMAND.

[2. *Mass*.—1. FORWARD, 2. MARCH.

[(c) 1. *Instructor*.—1. BY THE RIGHT FLANK, 2. COMMAND.

[2. *Mass*.—1. BY THE RIGHT FLANK, 2. MARCH.

[(4) When the instructor desires to terminate mass com-  
[mands he cautions, "At my command."

## CHAPTER 2

### THE SOLDIER WITHOUT ARMS

SECTION I. General .....	Paragraphs 14-15
II. Positions .....	16-20
III. Steps and marchings .....	21-32

#### SECTION I

#### GENERAL

■ 14. DUTIES OF INSTRUCTOR.—The instructor explains briefly each movement, first executing it himself. He requires the recruits to take the proper positions unassisted and touches them only for the purpose of correction when they are unable to correct themselves. He avoids keeping the recruits too long at any position or movement. Each position or movement should be understood before passing to another. The instructor exacts by degrees the desired precision and uniformity.

■ 15. GROUPING RECRUITS.—*a.* Recruits are separated into small groups consistent with the available number of trained instructors in order to facilitate individual instruction. Each group is formed as a squad (see par. 115).

*b.* As instruction progresses, the recruits are grouped according to proficiency. Those who show a lack of aptitude and quickness are separated from the others and placed under the most experienced drill masters. Care should be taken that men who are naturally inapt are not ridiculed or treated harshly; an officer should carefully superintend the

instruction of such men to insure that they are given firm but quiet and considerate handling.

## SECTION II

### POSITIONS

■ 16. POSITION OF THE SOLDIER, OR OF ATTENTION.—*a.* Heels on the same line and as near each other as the conformation of the man permits.

*b.* Feet turned out equally and forming an angle of 45°.

*c.* Knees straight without stiffness.

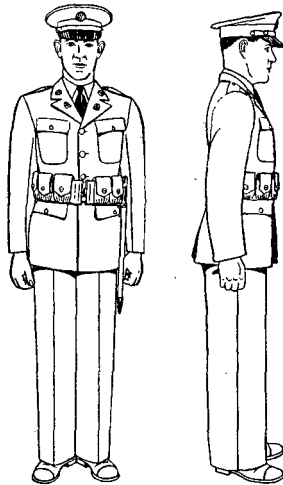

FIGURE 1.—Position of the soldier, or of attention.

*d.* Hips level and drawn back slightly; body erect and resting equally on hips, chest lifted and arched; shoulders square and falling equally.

*e.* Arms hanging straight down without stiffness so that the thumbs are along the seams of the trousers; back of the hands out; fingers held naturally.

*f.* Head erect and squarely to the front; chin drawn in so that the axis of the head and neck is vertical; eyes straight to the front.

*g.* Weight of the body resting equally on the heels and the balls of the feet.

*h.* In assuming the position of the soldier, or of attention, the heels are brought together smartly and audibly.

■ 17. **RESTS.**—Being at a halt, the commands are: **FALL OUT; REST; AT EASE;** and 1. **PARADE,** 2. **REST.**

*a.* At the command **FALL OUT,** the men leave the ranks but are required to remain in the immediate vicinity. The men resume their former places at attention at the command **FALL IN.** On the march, men will fall in **AT EASE** unless they were at attention when the command **FALL OUT** was given.

*b.* At the command **REST,** one foot is kept in place. Silence and immobility are not required.

*c.* At the command **AT EASE,** the right foot is kept in place. Silence but not immobility is required.

*d.* At the command of execution, **REST,** of 1, **PARADE,** 2. **REST,** move the left foot smartly 12 inches to the left of the right foot keeping the legs straight so that the weight of the body rests equally on both feet. At the same time, clasp the hands behind the back, palms to the rear, thumb and fingers of the right hand clasping the left thumb without constraint; preserve silence and immobility.

*e.* Being at any of the rests except **FALL OUT,** to resume the position of attention, the commands are: 1. **SQUAD,** 2. **ATTENTION.** At the command **ATTENTION** take the position of the soldier as prescribed in paragraph 16.

■ 18. **EYES RIGHT OR LEFT.**—The commands are: 1. **EYES,** 2. **RIGHT (LEFT),** 3. **READY,** 4. **FRONT.** At the command **RIGHT,** each man turns his head and eyes to the right. At the command **FRONT,** the head and eyes are turned to the front.

■ 19. **FACINGS.**—All facings are executed from the halt and in the cadence of quick time.

*a. To the flank.*—(1) The commands are: 1. **RIGHT (LEFT),** 2. **FACE.** At the command **FACE,** slightly raise the left heel and the right toe; face to the right, turning on the right heel, assisted by a slight pressure on the ball of the left foot. Hold the left leg straight without stiffness. (**TWO**) Place the left foot beside the right.

(2) Execute **LEFT FACE** on the left heel in a corresponding manner.

*b. To the rear.*—The commands are: 1. **ABOUT,** 2. **FACE.**



At the command **FACE**, carry the toe of the right foot a half-foot length to the rear and slightly to the left of the left heel without changing the position of the left foot; weight of the body mainly on the heel of the left foot; right leg straight without stiffness. (**TWO**) Face to the rear, turning to the right on the left heel and on the ball of the right foot; place the right heel beside the left.

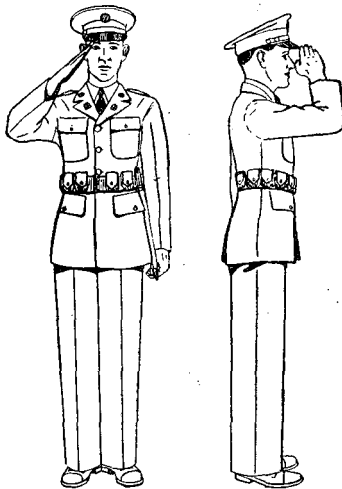

FIGURE 2.—Hand salute.

■ 20. SALUTE WITH HAND.—*a.* The commands are: 1. **HAND**, 2. **SALUTE**. At the command **SALUTE**, raise the right hand smartly until the tip of the forefinger touches the lower part of the headdress or forehead above and slightly to the right of the right eye, thumb and fingers extended and joined, palm to the left, upper arm horizontal, forearm inclined at  $45^{\circ}$ , hand and wrist straight; at the same time turn the head and eyes toward the person saluted. (**TWO**) Drop the arm to its normal position by the side in one motion, at the same time turning the head or eyes to the front.

*b.* Execute the first position of the hand salute when 6 paces from the person saluted, or at the nearest point of approach, if more than 6 paces. Hold the first position until

the person saluted has passed or the salute is returned. Then execute the second movement of the hand salute.

### SECTION III

#### STEPS AND MARCHINGS

■ 21. **GENERAL.**—*a.* All steps and marchings executed from the halt, except right step, begin with the left foot.

*b.* The instructor indicates the proper cadence when necessary by calling "One," "Two," "Three," "Four," as the left and right foot respectively strike the ground.

■ 22. **QUICK TIME.**—Being at a halt, to march forward in quick time, the commands are: 1. FORWARD, 2. MARCH. At the command FORWARD, shift the weight of the body to the right leg without perceptible movement. At the command MARCH, step off smartly with the left foot and continue the march with 30-inch steps taken straight forward without stiffness or exaggeration of movements. Swing the arms easily in their natural arcs, 6 inches to the front and 3 inches to the rear of the body.

■ 23. **DOUBLE TIME.**—*a.* Being at a halt or in march in quick time, to march in double time the commands are: 1. DOUBLE TIME, 2. MARCH.

(1) If at a halt, at the command DOUBLE TIME, shift the weight of the body to the right leg without perceptible movement. At the command MARCH, raise the forearms, fingers closed, knuckles out, to a horizontal position along the waistline, take up an easy run with the step and cadence of double time, allowing a natural swinging motion to the arms.

(2) If marching in quick time, at the command MARCH, given as either foot strikes the ground, take one more step in quick time and then step off in double time.

*b.* To resume the quick time from double time the commands are: 1. QUICK TIME, 2. MARCH. At the command MARCH, given as either foot strikes the ground, advance and plant the other foot in double time; resume the quick time, dropping the hands by the sides.

■ 24. **HALT.**—*a.* To halt when marching in quick time, the commands are: 1. SQUAD, 2. HALT. At the command HALT, given as either foot strikes the ground, execute the halt in

two counts by advancing and planting the other foot and then bringing up the foot in rear.

b. To halt when marching in double time, the commands are: 1. SQUAD, 2. HALT. At the command HALT, given as either foot strikes the ground, advance and plant the other foot as in double time, then halt in two counts as in quick time.

c. To halt from side step the commands are: 1. SQUAD, 2. HALT. At the command HALT, given as the heels are together, plant the foot next in cadence and come to the halt when the heels are next brought together.

■ 25. MARK TIME.—The commands are: 1. MARK TIME, 2. MARCH.

a. Being in march, at the command MARCH, given as either foot strikes the ground, advance and plant the other foot; bring up the foot in rear, placing it so that both heels are on line and continue the cadence by alternately raising and planting each foot. The feet are raised 2 inches from the ground.

b. Being at a halt, at the command MARCH, raise and plant first the left foot, then the right as prescribed above.

c. Mark time may be executed in either quick time or double time.

d. The halt is executed from mark time as from quick time or double time by taking 2-inch vertical in place of 30-inch horizontal steps. Forward, halt, and mark time may be executed one from the other in quick or double time.

■ 26. HALF STEP.—a. The commands are: 1. HALF STEP, 2. MARCH. At the command MARCH, take steps of 15 inches in quick time in the same manner as prescribed in paragraph [22. The half step is executed in quick time only.

b. To resume the full step from half step or mark time the commands are: 1. FORWARD, 2. MARCH.

■ 27. SIDE STEP.—a. Being at a halt the commands are: 1. RIGHT (LEFT) STEP, 2. MARCH. At the command MARCH, carry the right foot 12 inches to the right; place the left foot beside the right, left knee straight. Continue in the cadence of quick time.

[b. The side step is executed in quick time from a halt and [for short distances only.

■ 28. **BACK STEP.**—*a.* Being at a halt the commands are: 1. **BACKWARD**, 2. **MARCH**. At the command **MARCH**, take steps of 15 inches straight to the rear.

■ [*b.* The back step is executed in quick time, from a halt and [for short distances only.

■ 29. **FACE IN MARCHING.**—The facings in marching are an important part of movements such as, **COLUMN RIGHT**, **CLOSE**, **TAKE INTERVAL**, **EXTEND**, etc.

*a.* To face to the right in marching and advance from a halt, at the command of execution of the movement, turn to the right on the ball of the right foot and at the same time step off in the new direction with the left foot with a half step, full step, or in double time, as the case may be.

*b.* To face to the right in marching and advance, being in march, at the command of execution, given as the right foot strikes the ground, advance and plant the left foot, then face to the right in marching and step off in the new direction with the right foot with a half step, full step, or in double time, as the case may be.

*c.* To face to the rear in marching, being in march, the commands are: 1. **TO THE REAR**, 2. **MARCH**. At the command **MARCH**, given as the right foot strikes the ground, advance and plant the left foot; turn to the right about on the balls of both feet and immediately step off with the left foot.

■ 30. **MARCH BY FLANK.**—Being in march, the commands are: 1. **BY THE RIGHT (LEFT) FLANK**, 2. **MARCH**. At the command **MARCH**, given as the right foot strikes the ground, advance and plant the left foot, then face to the right in marching and step off in the new direction with the right foot.

■ 31. **CHANGE STEP.**—The commands are: 1. **CHANGE STEP**, 2. **MARCH**.

*a.* Being in march in quick time, at the command **MARCH**, given as the right foot strikes the ground, advance and plant the left foot; plant the toe of the right foot near the heel of the left and step off with the left foot.

*b.* Execute the change on the right foot similarly, the command **MARCH** being given as the left foot strikes the ground.

■ 32. **MARCH OTHER THAN AT ATTENTION.**—The commands are: 1. **ROUTE STEP**, 2. **MARCH**; or 1. **AT EASE**, 2. **MARCH**.

*a.* 1. **ROUTE STEP**, 2. **MARCH**. At the command **MARCH**, men

are not required to march at attention, in cadence, or to maintain silence.

b. 1. AT EASE, 2. MARCH. At the command MARCH, men are not required to march at attention or in cadence but they will maintain silence.

## CHAPTER 3

### THE SOLDIER WITH ARMS

	Paragraphs
SECTION I. General .....	33-34
II. Manual of arms for rifle .....	35-58
III. Loading and firing .....	59-64
IV. Carrying automatic rifle .....	65
V. Manual of the pistol .....	66-82
VI. Manual of the guidon .....	83-94
VII. Manual of the color and standard .....	95-103
VIII. Manual of the saber .....	104-113

#### SECTION I

#### GENERAL

■ 33. INSTRUCTION OF RECRUIT.—As soon as practicable, the recruit is taught the use, care, and nomenclature of the rifle. When fair progress has been made in instruction without arms, he is taught the manual of arms. Instruction without arms and with arms should alternate.

■ 34. RULES GOVERNING CARRYING RIFLE.—Except where otherwise indicated, these rules will be applicable alike to the U. S. rifle, caliber .30, M1903, and to the U. S. rifle, caliber .30, M1.

a. (1) The U. S. rifle, caliber .30, M1903, is not carried with cartridges in either the chamber or the magazine except when specifically ordered. When so loaded or when supposed to be loaded, it is habitually carried locked; that is, with the safety lock turned to the "safe". At all other times it is carried unlocked with the trigger pulled. The cut-off is kept turned off except when cartridges are actually used.

(2) Whenever troops equipped with the U. S. rifle, caliber .30, M1903, are formed under arms, pieces are immediately inspected at the commands: 1. INSPECTION, 2. ARMS. A similar inspection is made before dismissal. If cartridges are found in the chamber or magazine they are removed and placed in the belt.

b. (1) The U. S. rifle, caliber .30, M1, is not carried with cartridges in either the chamber or the receiver except when specifically ordered. When so loaded or when supposed to be loaded, it is habitually carried locked; that is, with the safety in its rearmost position, inside the trigger guard.

(2) Whenever troops equipped with the U. S. rifle, caliber .30, M1, are formed under arms, pieces are immediately inspected at the commands: 1. INSPECTION, 2. ARMS, 3. LOCK PIECES. At the command LOCK PIECES, each man in ranks closes the bolt, sets the safety of his piece in its rearmost position, and resumes PORT ARMS. Rifles are again inspected at dismissal by the commands: 1. INSPECTION, 2. ARMS, 3. UNLOCK PIECES. At the command UNLOCK PIECES, each man in ranks closes the bolt, sets the safety of his piece in its foremost position, pulls the trigger, and resumes PORT ARMS. If cartridges are found in the chamber or receiver, they are removed and placed in the belt. The procedure prescribed for these inspections is intended, first, to insure that U. S. rifles, caliber .30, M1, in the hands of troops are carried cocked and locked; second, to insure that hammers are released on unloaded pieces not in use to prevent damage from long continued compression of the hammer springs.

c. The bayonet is fixed only when so ordered.

d. FALL IN is executed with the rifle at the ORDER ARMS.

e. (1) Before starting any movement for troops armed [with rifles, the commands, 1. RIGHT SHOULDER (SLING), 2. ARMS, are given *before* the command for movement.

[(2) Movements for short distances may be executed AT THE TRAIL by prefacing the preparatory command with the words "at trail," as 1. AT TRAIL, FORWARD, 2. MARCH. The trail is taken at the command MARCH.

(3) Weapons such as the automatic rifle, light machine gun, light mortar, etc., which have no manual of arms are slung from the right shoulder at the command of execution, ARMS, of 1, RIGHT SHOULDER, 2. ARMS. They are kept slung until the command REST OR AT EASE. In long halts at attention, the men carrying such equipment may be directed to ["unsling arms." (See par. 65c.)

f. When the facings, alinements, open and close ranks, side step, back step, forming for shelter tents, extending and closing are executed from the order, the weapon is brought

to the trail while in motion and the order resumed on halting. The position of TRAIL ARMS is taken at the command of execution in each case.

*g.* At the command HALT, men armed with the rifle remain at the position of right (left) shoulder arms until the command: 1. ORDER, 2. ARMS, is given.

*h.* In double time under arms, a disengaged hand is held as when without arms.

## SECTION II

### MANUAL OF ARMS FOR RIFLE

■ 35. RULES GOVERNING EXECUTION OF MANUAL OF ARMS.—Except where otherwise indicated, these rules will be applicable alike to the U. S. rifle, caliber .30, M1903, and to the U. S. rifle, caliber .30 M1.

*a.* In all positions of the left hand at the balance, the thumb clasps the rifle; the sling is included in the grasp of the hand (fig. 3). In describing the manual of arms, the term "at the balance" refers to points on rifles as follows:

(1) *U. S. rifle, caliber .30, M1903.*—The center of the rear sight leaf.

(2) *U. S. rifle, caliber .30, M1.*—A point just forward of the trigger housing.

*b.* In all positions of the rifle, diagonally across the body, the barrel is up, butt in front of the right hip, barrel crossing opposite the junction of the neck with the left shoulder. The rifle is grasped at the balance with the left hand, palm toward the body, wrist straight.

*c.* The cadence of the motions is that of quick time. Recruits are first required to give their whole attention to the details of the motions, the cadence being gradually acquired as they become accustomed to handling their rifles. The instructor may require them to count aloud in cadence with the motions.

*d.* (1) The manual is not executed in marching except to pass from right shoulder to left shoulder or port arms and the reverse in marching at attention. These movements may be used to add interest to the drill or to prevent fatigue in long marches at attention.

(2) The manual is taught at a halt and the movements for the purpose of instruction may be divided into motions

and executed in detail. In this case, the command of execution determines the prompt execution of the first motion,



FIGURE 3.—Left hand at the balance.

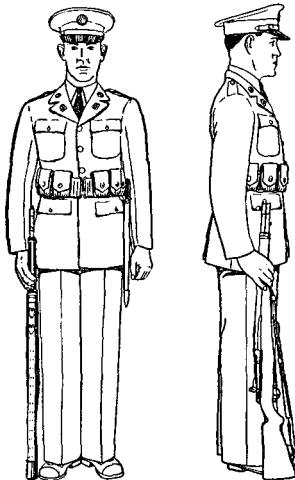

FIGURE 4.—Position of ORDER ARMS.



and the commands TWO, THREE, FOUR, that of the other motions.

(3) To execute the movement in detail, the instructor first cautions, "By the numbers." All movements divided into motions are then executed as above explained until he cautions, "Without the numbers."

*e.* (1) Any appropriate position of the manual of arms may be ordered from a previous position by giving the suitable commands.

(2) Under exceptional conditions of weather and fatigue, the rifle may be carried as directed.

■ 36. POSITION OF ORDER ARMS.—The butt of the rifle rests on the ground, barrel to the rear, toe of the butt on line with the toe of, and touching the right shoe, right hand holding the rifle between the thumb and fingers, left hand as in position of the soldier without arms.



FIGURE 5.—Position of TRAIL ARMS.

■ 37. BEING AT ORDER ARMS.—1. TRAIL, 2. ARMS. At the command ARMS, raise the rifle and incline the muzzle forward so that the barrel makes an angle of about  $15^{\circ}$  with the vertical, the right arm slightly bent.

■ 38. BEING AT TRAIL ARMS.—1. ORDER, 2. ARMS. At the command ARMS, lower the rifle with the right hand and resume the order.

■ 39. BEING AT ORDER ARMS TO SLING ARMS, AND BEING AT SLING ARMS TO UNSLING ARMS.—*a.* SLING ARMS. This movement is not executed in cadence and applies to any rifle, automatic rifle, light machine gun, light mortar, etc. Loosen the sling, if not already loosened, and in the most convenient manner assume the position shown in figure 6. This position is authorized for long parades, long reviews, and for occasions when the prolonged holding of the rifle becomes a hardship on the troops. When used in ceremonies the bayonet may be fixed.

*b.* 1. UNSLING, 2. ARMS, 3. ADJUST, 4. SLINGS. At the command ARMS, pieces are unslung. At the command SLINGS,

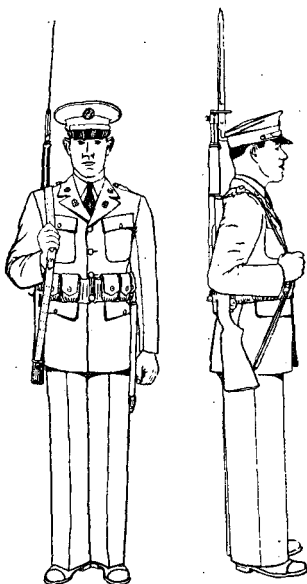
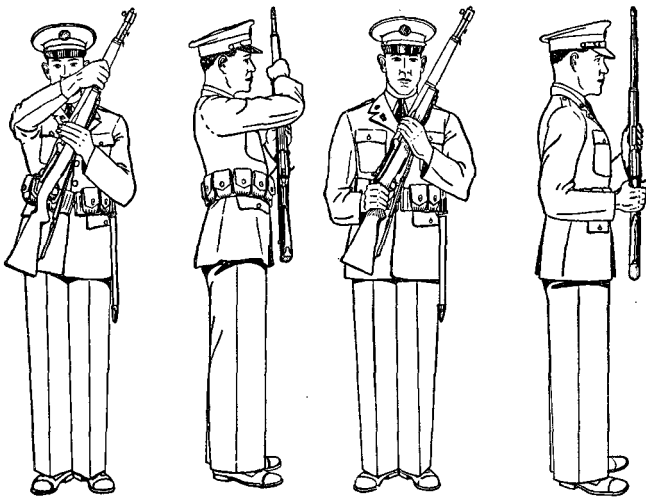

FIGURE 6.—Position of SLING ARMS.

slings are adjusted to the drill position. This adjustment of the sling will be made before precise movements of the manual are to be executed.

■ 40. BEING AT ORDER ARMS.—1. PORT, 2. ARMS. At the command ARMS, raise the rifle with the right hand and carry it diagonally across the front of the body until the right hand is in front of and slightly to the left of the chin (fig. 7①), so that the barrel is up, butt in front of the right hip, barrel



① First position.

② Second position.

FIGURE 7.—Position of PORT ARMS.

crossing opposite the junction of the neck with the left shoulder. At the same time, grasp the rifle at the balance with the left hand, palm toward the body, wrist straight. (TWO) Carry the right hand to the small of the stock, grasping it, palm down, holding right forearm horizontal; left elbow resting against the body; the rifle in a vertical plane parallel to the front (fig. 7②).

■ 41. BEING AT ORDER ARMS.—1. PRESENT, 2. ARMS. At the command ARMS, with the right hand carry the rifle in front of the center of the body, barrel to the rear and vertical, grasp it with the left hand at the balance, forearm horizontal and resting against the body. (TWO) Grasp the small of the stock with the right hand

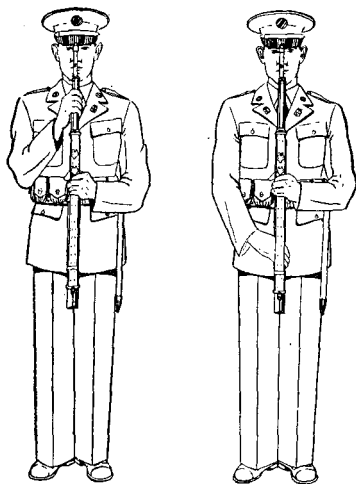

FIGURE 8.—Execution of PRESENT ARMS.

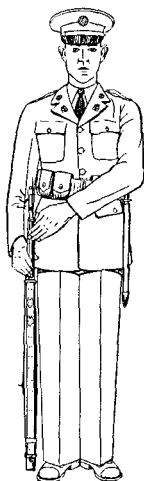

FIGURE 9.—Next to last position of ORDER ARMS.

■ 42. BEING AT PRESENT OR PORT ARMS.—1. ORDER, 2. ARMS. At the command ARMS, let go of the rifle with the right hand and regrab the piece between the upper sling swivel and

stacking swivel. (TWO) Let go of the rifle with the left hand, lower the piece to the right so that the butt is 3 inches from the ground, barrel to the rear, left hand with the fingers extended and joined steadying the rifle, forearm and wrist straight and inclining downward. (THREE) Complete the order by lowering the rifle gently to the ground with the right hand. Cut away the left hand smartly to the side. Allowing the rifle to drop to the ground forcibly injures the rifle and is prohibited.

■ 43. BEING AT ORDER ARMS.—*a. U. S. rifle, caliber .30, M1903.*—1. INSPECTION, 2. ARMS. At the command ARMS, take the position of PORT ARMS. Seize the bolt handle with the thumb and forefinger of the right hand, turn the handle up, draw the bolt back, lower the head and eyes sufficiently to glance into the magazine. Having found the magazine empty, or having emptied it, raise the head and eyes to the front.

*b. U. S. rifle, caliber .30, M1.*—1. INSPECTION, 2. ARMS. At the command ARMS, take the position of PORT ARMS. With the fingers of the left hand closed, place the left thumb on the operating rod handle and push it smartly to the rear until it is caught by the operating rod catch; at the same time lower the head and eyes sufficiently to glance into the receiver. Having found the receiver empty, or having emptied it, raise the head and eyes to the front, at the same time regrasp the piece with the left hand at the balance.

■ 44. BEING AT INSPECTION ARMS.—*a. U. S. rifle, caliber .30, M1903.*—1. ORDER (RIGHT SHOULDER, PORT), 2. ARMS. At the preparatory command, push the bolt forward, turn the handle down, pull the trigger, and resume PORT ARMS. At the command ARMS, complete the movement ordered.

*b. U. S. rifle, caliber .30, M1.*—1. LOCK PIECES, 2. ORDER (RIGHT SHOULDER), 3. ARMS, or 1. UNLOCK PIECES, 2. DISMISSED. At the command LOCK (OR UNLOCK) PIECES, place the right side of the right hand against the operating rod handle with the fingers extended and joined and the thumb on the follower. (TWO) Force the operating rod handle slightly to the rear, depress the follower with the right thumb, and permit the bolt to ride forward about 1 inch over the follower. (THREE) Remove the thumb from the follower and release the operating rod handle. (FOUR) Lock the piece, or unlock the piece and pull the trigger as the case may be (par. 34b(2)) and

resume the position of PORT ARMS. After the pieces have been locked or unlocked, as prescribed above, ORDER or RIGHT SHOULDER ARMS is given or the unit is dismissed.

■ 45. BEING AT ORDER ARMS.—1. RIGHT SHOULDER, 2. ARMS. At the command ARMS, raise and carry the rifle diagonally across the body with the right hand as shown in figure 10, at the same time grasp it at the balance with the left hand. (TWO) Regrasp it with the right hand on the butt, the heel between the first two fingers, thumb and fingers closed on the stock. (THREE) Without changing the grasp of the right hand, place the rifle on the right shoulder, barrel up and inclined at an angle of about  $45^{\circ}$  from the horizontal, trigger guard in the hollow of the shoulder, right elbow against the side, forearm horizontal, the rifle in a vertical plane perpendicular to the front, carry the left hand, thumb and fingers extended and joined, to the small of the stock, first joint of the forefinger touching the cocking piece (or, for the M1 rifle, touching the rear end of the receiver),

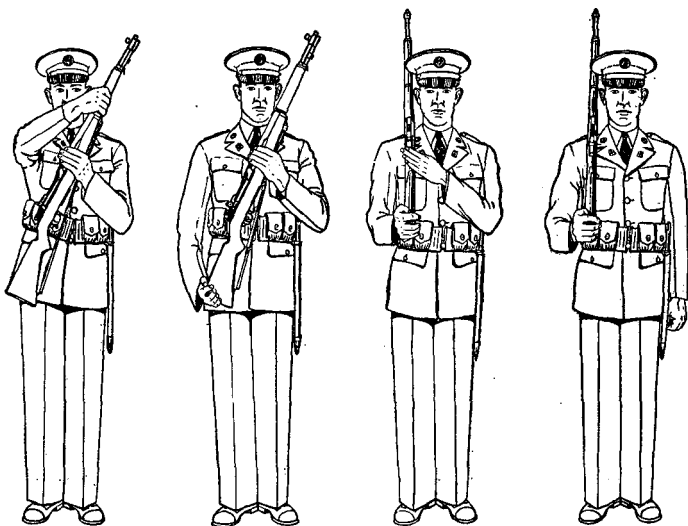

FIGURE 10.—Execution of RIGHT SHOULDER ARMS.

wrist straight, and elbow down. (FOUR) Cut away the left hand smartly to the side.

■ 46. BEING AT RIGHT SHOULDER ARMS.—1. PORT, 2. ARMS. At the command ARMS, press the butt down quickly and throw the rifle diagonally across the body, at the same time turning it to the left so as to bring the barrel up, the right hand retaining its grasp on the butt, the left grasping the rifle at the balance. (TWO) Change the right hand to the small of the stock.

■ 47. BEING AT RIGHT SHOULDER ARMS.—1. ORDER, 2. ARMS. At the command ARMS, press the butt down quickly and throw the rifle diagonally across the body, the right hand retaining the grasp on the butt, the left hand grasping the rifle at the balance. Then execute ORDER ARMS as described in paragraph 42.

■ 48. BEING AT PORT ARMS.—1. RIGHT SHOULDER, 2. ARMS. At the command ARMS, change the right hand to the butt as described in paragraph 45. (TWO), (THREE) Execute the last two movements as in RIGHT SHOULDER ARMS from ORDER ARMS.

■ 49. BEING AT ORDER ARMS.—1. PARADE, 2. REST. At the command REST, move the left foot smartly 12 inches to the left of the right foot, keeping the legs straight so that the weight of the body rests equally on both feet. At the same time incline the muzzle of the rifle to the front, the right arm extended, right hand grasping the rifle just below the upper band. Hold the left hand behind the body, resting in the small of the back, palm to the rear.

■ 50. BEING AT PARADE REST.—1. SQUAD, 2. ATTENTION. At the command ATTENTION, resume the position of ORDER ARMS.

■ 51. BEING AT RIGHT SHOULDER ARMS.—1. LEFT SHOULDER, 2. ARMS. At the command ARMS, execute PORT ARMS in two counts as described in paragraph 46. (THREE) Let go of the rifle with the left hand and with the right hand still grasping the small of the stock place it on the left shoulder, barrel up, trigger guard in the hollow of the shoulder; at the same time grasp the butt with the left hand, heel between the first and second fingers, thumb and fingers closed on the stock, left forearm horizontal, left elbow against the side, the rifle in a vertical plane perpendicular to the front. (FOUR) Drop the right hand quickly to the right side.

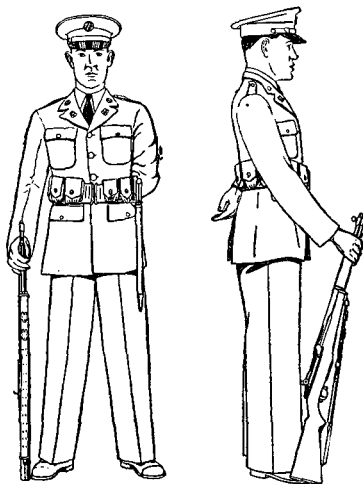

FIGURE 11.—POSITION OF PARADE REST.

■ 52. BEING AT LEFT SHOULDER ARMS.—*a.* 1. PORT, 2. ARMS. At the command ARMS, grasp the rifle with the right hand at the small of the stock. (TWO) Let go with the left hand and at the same time carry the piece with the right hand to the position of PORT ARMS and then regrab it with the left.

*b.* LEFT SHOULDER ARMS may be ordered directly from the ORDER, RIGHT SHOULDER, OR PRESENT. At the command ARMS, execute PORT ARMS and continue in cadence to the position ordered.

■ 53. BEING AT LEFT SHOULDER ARMS.—1. RIGHT SHOULDER, 2. ARMS. At the command ARMS, execute PORT ARMS as described in paragraph 52, and then RIGHT SHOULDER ARMS as described in paragraph 48.

■ 54. BEING AT LEFT SHOULDER ARMS.—1. ORDER, 2. ARMS. At the command ARMS, execute PORT ARMS as described in paragraph 52 and complete the movement of ORDER ARMS as described in paragraph 42.

■ 55. BEING AT ORDER OR TRAIL ARMS.—1. RIFLE, 2. SALUTE. At the command SALUTE carry the left hand smartly to the



right side, palm of the hand down, thumb and fingers extended and joined, forearm and wrist straight, first joint of forefinger between the stacking swivel and the muzzle as nearly as the conformation of the man permits, and look toward the person saluted. (TWO) Cut away the left hand smartly to the side; turn the head and eyes to the front.

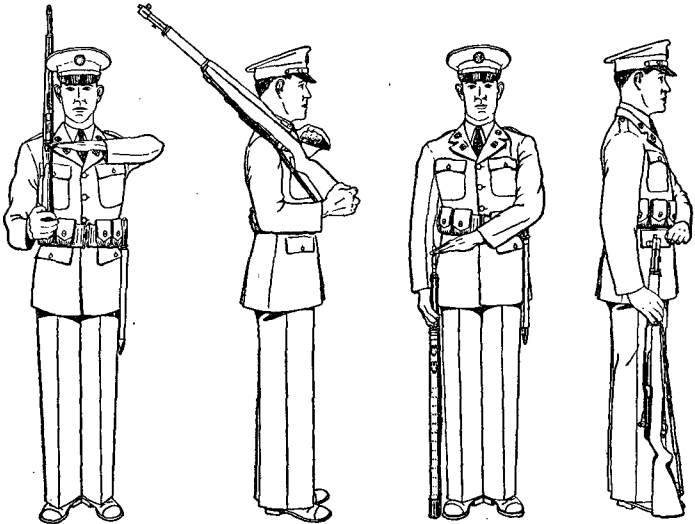

FIGURE 12.—Rifle salute at RIGHT SHOULDER ARMS and at ORDER ARMS.

■ 56. BEING AT RIGHT SHOULDER ARMS.—1. RIFLE, 2. SALUTE. At the command SALUTE, carry the left hand smartly to small of the stock, forearm horizontal, palm of the hand down, thumb and fingers extended and joined, first joint of the forefinger touching end of cocking piece (or, for the M1 rifle, touching the rear end of the receiver); look toward the person saluted. (TWO) Cut away the left hand smartly to the side; turn the head and eyes to the front.

■ 57. BEING AT ORDER ARMS.—1. FIX, 2. BAYONETS. At the command BAYONETS—

a. If the bayonet scabbard is carried on the belt, move the muzzle of the rifle to the left front and grasp the rifle below the stacking swivel with the left hand; grasp the

bayonet with the right hand, back of the hand toward the body; pressing the spring with the forefinger, draw the bayonet from the scabbard and fix it on the barrel, glancing at the muzzle; resume the order.

b. If the bayonet is carried on the haversack, draw and fix the bayonet in the most convenient manner.

c. These movements are not executed in cadence.

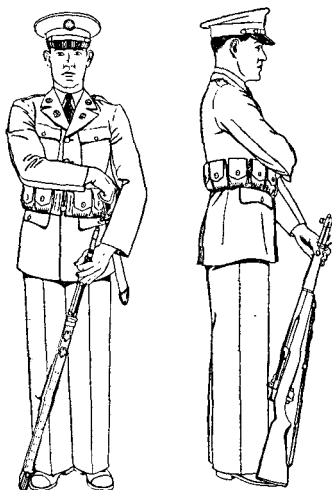

FIGURE 13.—Fix bayonets.

■ 58. BEING AT ORDER ARMS.—1. UNFIX, 2. BAYONETS. At the command BAYONETS—

a. If the bayonet scabbard is carried on the belt, take the position for fixing bayonets; grasp the handle of the bayonet with the right hand, pressing the spring, raise the bayonet until the handle is about 12 inches above the muzzle of the rifle; drop the point to the left, back of the hand toward the body and, glancing at the scabbard, return the bayonet, the blade passing between the left arm and the body; re-grasp the rifle with the right hand and resume the order.

b. If the bayonet scabbard is carried on the haversack, take the bayonet from the rifle as described above and return it to the scabbard in the most convenient manner.

c. These movements are not executed in cadence.

SECTION III  
LOADING AND FIRING

■ 59. GENERAL RULES.—Except where otherwise indicated, these rules will be applicable alike to the U. S. rifle, caliber .30, M1903, and the U. S. rifle, caliber .30, M1.

a. For ceremonial firing, the front rank only of units larger than a squad executes the loading and firing. A squad is always formed in line preliminary to such firing.

b. Rifles, caliber .30, M1903, are loaded and locked before any orders for firing are given. Rifles, caliber .30, M1, are loaded while locked. (See par. 34b(2).)

c. Except during firing, if rifles have been ordered loaded and locked, they are kept loaded and locked without command until the command UNLOAD, or 1. INSPECTION, 2. ARMS. During firing, fresh clips will be inserted when the magazine or clip is exhausted.

d. Except when used as a single loader, the U. S. rifle, caliber .30, M1, is habitually loaded by placing a full clip of eight cartridges in the receiver.

■ 60. LOAD.—a. The unit being in any formation, standing at a halt, the commands are: 1. WITH BALL (BLANK, DUMMY, GUARD) CARTRIDGES, 2. LOAD.

(1) *U. S. rifle, caliber .30; M1903.*—At the command LOAD, each front rank rifleman faces half right and carries the right foot 12 inches to the right and to such position as will insure the greatest firmness and steadiness of the body, raises or lowers the rifle and drops it into the left hand at the balance, left thumb extending along the stock, muzzle pointed into the air at an angle of 45°, and turns the cut-off up. With the right hand he turns up the bolt and draws it back; takes a loaded clip and inserts the end in the clip slots; places his thumb on the powder space of the top cartridge, the fingers extending around the rifle and tips resting on the magazine floor plate; forces the cartridges into the magazine by pressing down with the thumb; removes the clip; thrusts the bolt home, turning down the handle; turns the safety lock to the "safe" and carries the hand to the small of the stock. Automatic riflemen do not execute the ceremonial loadings or firings.

(2) *U. S. rifle, caliber .30, M1.*—At the command **LOAD**, each front rank rifleman faces half right and carries his right foot 12 inches to the right and to such position as will secure the greatest firmness and steadiness of the body, raises or lowers the rifle and drops it into the left hand at the balance, right hand at the small of the stock, muzzle in the air at an angle of 45°. With the forefinger of the right hand, he pulls the operating rod handle smartly to the rear until the operating rod is caught by the operating rod catch. With his right hand he takes a fully loaded clip and places it on top of the follower. He places the right side of his right hand against the operating rod handle and with his thumb presses the clip down into the receiver until it engages the clip latch. He swings his thumb to the right so as to clear the bolt in its forward movement. He releases the operating rod handle. He then pushes forward on the operating rod handle with the heel of his right hand to make certain of complete closing of the bolt and carries his right hand to the small of the stock. Automatic riflemen do not execute the ceremonial loadings and firings.

b. For instruction in loading, the commands are: 1. **SIMULATE**, 2. **LOAD**.

(1) *U. S. rifle, caliber .30, M1903.*—At the command **LOAD**, execute loading as described in *a*(1) above, except that the cut-off remains "off" and the handling of the cartridge is simulated.

(2) *U. S. rifle, caliber .30, M1.*—At the command **LOAD**, execute loading as described in *a*(2) above except that the handling of cartridges is simulated.

c. (1) The *U. S. rifle, caliber .30, M1903*, may be used as a single loader by turning the cut-off to "off". At the command **LOAD**, the magazine may be filled in whole or in part by pressing cartridges singly down and back until they are in the proper place. The use of the rifle as a single loader is, however, to be regarded as exceptional.

(2) To use the *U. S. rifle, caliber .30, M1*, as a single loader, at the command **LOAD**, take the position of **LOAD** and open the bolt. With the right hand, place one round in the chamber, seating it in place with the thumb. With the side of the right hand against the operating rod handle and the fingers extended and joined, force the operating rod handle slightly to the rear, depress the follower with the right thumb, and

permit the bolt to ride forward about 1 inch over the follower. Then remove the thumb from the follower, release the operating rod handle and push forward on the operating rod handle with the heel of the hand to be certain that the bolt is completely closed. Carry the right hand to the small of the stock.

■ 61. UNLOAD.—Being in any formation, the command is: UNLOAD.

a. *U. S. rifle, caliber .30, M1903.*—At the command UNLOAD, take the position of LOAD, turn the safety lock up, and move the bolt alternately backward and forward until all the cartridges are ejected. After the last cartridge is ejected, the chamber is closed by first thrusting the bolt forward slightly to free it from the stud holding it in place when the chamber is opened, pressing the follower down and back to engage it under the bolt, and then thrusting the bolt home. The trigger is then pulled, the cartridges are picked up, cleaned, and returned to the belt, and the rifle is brought to the order.

b. *U. S. rifle, caliber .30, M1.*—At the command UNLOAD, take the position of LOAD. Hook the right thumb over the operating rod handle, pull and hold the operating rod in the extreme rear position. Hold the rifle with the right hand, thumb on operating rod handle, fingers around trigger guard. Steady the rifle by pressing the stock against the right hip. Place the left hand over the receiver and release the clip latch with the left thumb. Catch the ejected clip in the left hand, return the clip to the belt, return the left hand to the balance. Place the right side of the right hand against the operating rod handle and force the operating rod slightly to the rear. Depress the follower with the right thumb and permit the bolt to ride forward about 1 inch over the follower. Remove the thumb from the follower and release the operating rod handle. Bring the rifle to the order.

■ 62. FIRE RIFLE.—a. *U. S. rifle, caliber .30, M1903, fully loaded with ball (blank or guard) ammunition.*—Squeeze the trigger for each shot. After each shot draw back and thrust home the bolt with the right hand, leaving the safety lock turned up to the “ready.”

b. *U. S. rifle, caliber .30, M1.*—(1) *Fully loaded with clips of ball ammunition.*—Squeeze the trigger for each shot.

When the eighth shot has been fired, the clip will be ejected automatically and the bolt will remain open for the insertion of a new clip.

(2) *Fully loaded with clips of blank or guard ammunition.*—Squeeze the trigger for each shot. After each shot, pull the operating rod handle to the rear with the right forefinger and release it. Push forward on the operating rod handle with the heel of the right hand to insure that the bolt is fully closed.

■ 63. FIRE BY VOLLEY.—*a.* Being in firing formation with rifles loaded, the commands are: 1. FRONT RANK, 2. READY, 3. AIM, 4. SQUAD, 5. FIRE. (For ceremonial purposes, blank ammunition is used and only the front rank executes the commands.)

(1) *U. S. rifle, caliber .30, M1903.*—At the command READY, take the position of LOAD, if not already in that position, and turn the safety lock to the "ready." At the command AIM, raise the rifle with both hands, butt placed and held firmly against the shoulder, left hand well under the rifle grasping it at or in front of the balance, rifle resting in the palm of the left hand, right elbow at the height of the shoulder, right cheek held firmly against the stock as far forward as it can be placed without straining. The rifle is raised 45° from the horizontal or, if ordered, at the horizontal. The left eye is closed, right eye looking through the notch of the rear sight. At the command FIRE, the trigger is squeezed rapidly; the rifle is then lowered to the position of LOAD and loaded.

(2) *U. S. rifle, caliber .30, M1.*—At the command READY, take the position of LOAD, if not already in that position. At the command AIM, raise the rifle with both hands, butt placed and held firmly against the shoulder, left hand well under the rifle grasping it at or in front of the balance, rifle resting in the palm of the left hand, right elbow at the height of the shoulder, right cheek held firmly against the stock as far forward as it can be placed without straining, and press the safety lock to its forward position with the trigger finger. The rifle is raised 45° from the horizontal or, if ordered, at the horizontal. The left eye is closed, right eye looking over the rear sight. At the command FIRE, the trigger is squeezed rapidly; the rifle is then lowered to the position of LOAD and loaded.

b. To continue the firing, the commands are: 1. AIM, 2. SQUAD, 3. FIRE.

(1) *U. S. rifle, caliber .30, M1903.*—Each command is executed as previously explained. LOAD (from the magazine) is executed by drawing back and thrusting home the bolt with

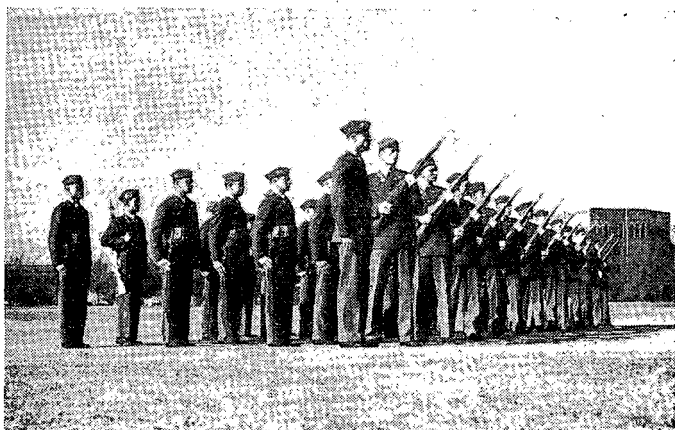

① Execute position of LOAD.

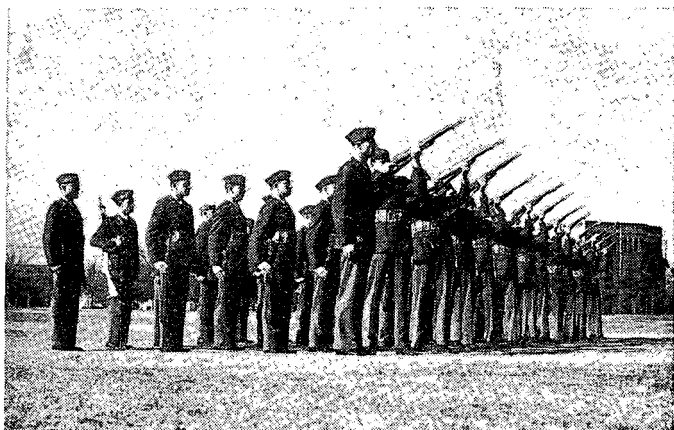

② Execute position of FIRE.

FIGURE 14.—Platoon in ceremonial firing.

the right hand, leaving the safety lock turned up to the "ready."

(2) *U. S. rifle, caliber .30, M1.*—Each command is executed as previously explained. **LOAD** (from the clip) is executed by pulling the operating rod handle fully to the rear with the right forefinger and releasing it, leaving the "safety" in its forward position.

■ 64. **CEASE FIRING.**—The command is: **CEASE FIRING.** At the command **CEASE FIRING**, firing stops; rifles not already at the position of **LOAD** are brought to that position.

#### SECTION IV

#### CARRYING AUTOMATIC RIFLE

■ 65. **GENERAL RULES.**—*a.* Except as otherwise prescribed, the automatic rifle is habitually carried slung over the right shoulder, butt down, barrel to the rear, right hand grasping the sling, hand in front of armpit.

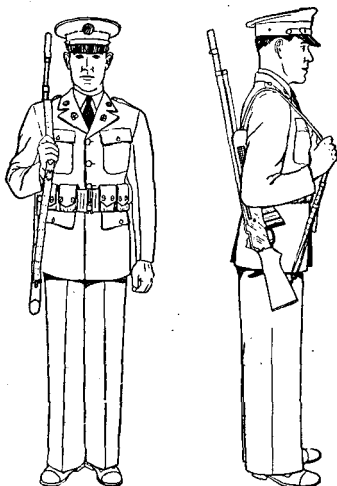

FIGURE 15.—Position of automatic rifle slung over right shoulder.

*b.* For marches and field exercises, the automatic rifle may be carried slung over either shoulder.

*c.* When troops are at ease, the automatic rifle is kept slung unless otherwise ordered.



*d.* When troops are at rest, the automatic rifle may be unslung and the position of ORDER ARMS taken.

*e.* Only the following movements of the manual are executed by the automatic rifleman:

(1) *Parade rest.*—If at SLING ARMS, execute as without arms keeping the right hand on the sling.

(2) *Inspection arms.*—At the command of execution, grasp the magazine with the left hand, at the same time press the magazine release with the right hand. Withdraw the magazine with the left hand and place it in the belt. Pull back the operating handle with the left hand.

(3) *Being at inspection arms.*—1. ORDER (PORT, RIGHT SHOULDER), 2. ARMS. At the command of execution, pull the trigger, replace the magazine, and resume the position of ATTENTION, the automatic rifle being kept slung.

*f.* Men armed with the automatic rifle execute inspection arms when a unit is formed or dismissed at the command: [1. INSPECTION, 2. ARMS.

*g.* Men armed with the automatic rifle salute with the hand salute when not in ranks. In ranks they do not salute.

*h.* For instruction, ceremonies, and drill, the organization commander at his discretion may substitute rifles for automatic rifles.

## SECTION V

### MANUAL OF THE PISTOL

■ 66. GENERAL.—*a.* The movements herein described differ in purpose from the manual of arms for the rifle in that they are not designed to be executed in exact unison. Furthermore, with only a few exceptions, there is no real necessity for their simultaneous execution. They are not therefore planned as a disciplinary drill to be executed in cadence with snap and precision, but merely as simple, quick, and safe methods of handling the pistol. Commands are prescribed for such movements only as may be occasionally executed simultaneously by the squad or larger unit.

*b.* In general, movements begin and end at the position of RAISE PISTOL.

*c.* Commands for firing, when required, are limited to COMMENCE FIRING and CEASE FIRING.

*d.* Officers and enlisted men armed with the pistol remain at the position of attention during the manual of arms, except

when their units are presented to their commanders or are presented during ceremonies, at retreat, and at guard mounting. In such cases they execute the hand salute at the command of execution, ARMS, of 1. PRESENT, 2. ARMS, and resume the position of attention at the command of execution of the next command.

[e. Men armed with the pistol execute inspection pistol [when a unit is formed or dismissed at the command: 1. INSPECTION, 2. ARMS.

[f. Whenever the pistol is carried mounted the lanyard will be used. The lanyard should be of such length that the arm may be fully extended without constraint.

#### DISMOUNTED

■ 67. RAISE PISTOL.—The commands are: 1. RAISE, 2. PISTOL. At the command PISTOL, unbutton the flap of the holster with the right hand and grasp the stock, back of the hand outward. Draw the pistol from the holster; reverse it, muzzle up, the thumb and last three fingers holding the stock, the forefinger extended outside the trigger guard, the barrel of the pistol to the rear and inclined to the front at an angle of 30°, the hand as high as, and 6 inches in front of, the point of the right shoulder. This is the position of RAISE PISTOL.

■ 68. WITHDRAW MAGAZINE.—Without lowering the right hand, turn the barrel slightly to the right; press the magazine catch with the right thumb and with the left hand remove the magazine. Place it in the belt or pocket.

■ 69. OPEN CHAMBER.—Withdraw the magazine and resume the position of RAISE PISTOL. Without lowering the right hand, grasp the slide with the thumb and the first two fingers of the left hand (thumb on left side of slide and pointing downward); keeping the muzzle elevated, shift the grip of the right hand so that the right thumb engages with the slide stop. Push the slide downward to its full extent and force the slide stop into its notch with the right thumb without lowering the muzzle of the pistol.

■ 70. CLOSE CHAMBER.—With the right thumb press down the slide stop and let the slide go forward. Squeeze the trigger.

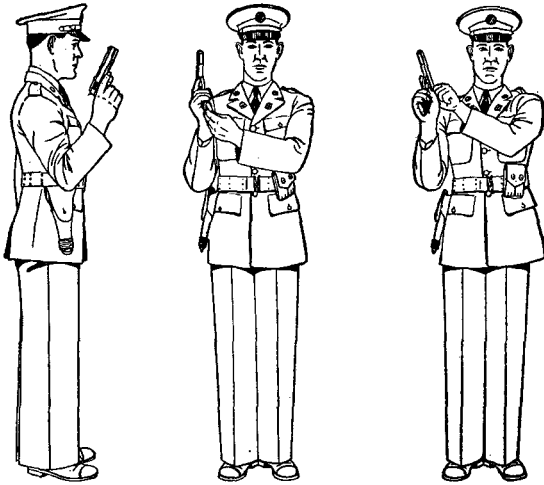

① Raise pistol. ② Withdraw magazine. ③ Pull slide downward in loading.

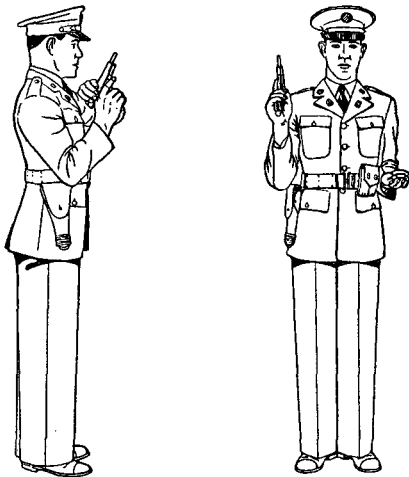

④ Open chamber.

⑤ Inspect pistol.

FIGURE 16.—Manual of the pistol (dismounted).

■ 71. INSERT MAGAZINE.—Without lowering the right hand, turn the barrel to the right. Grasp a magazine with the first two fingers and thumb of the left hand; withdraw it from the belt and insert it in the pistol. Press it fully home.

■ 72. LOAD PISTOL.—The commands are: 1. LOAD, 2. PISTOL. At the command PISTOL, if a loaded magazine is not already in the pistol, insert one. Without lowering the right hand, turn the barrel slightly to the left. Grasp the slide with the thumb and fingers of the left hand (thumb on right side of slide and pointing upward). Pull the slide downward to its full extent. Release the slide and engage the safety lock.

■ 73. UNLOAD PISTOL.—The commands are: 1. UNLOAD, 2. PISTOL. At the command PISTOL, withdraw the magazine. Open the chamber as prescribed in paragraph 72. Glance at the chamber to verify that it is empty. Close the chamber. Take the position of RAISE PISTOL and squeeze the trigger. Then insert an empty magazine.

■ 74. INSPECT PISTOL.—The commands are: 1. INSPECTION, 2. PISTOL. At the command PISTOL, withdraw the magazine. Open the chamber as prescribed in paragraph 69. Take the position of RAISE PISTOL. The withdrawn magazine is held in the open left hand at the height of the belt. After the pistol has been inspected, or at the command 1. RETURN, 2. PISTOL, close the chamber, take the position of RAISE PISTOL, and squeeze the trigger. Insert an empty magazine and execute RETURN PISTOL.

■ 75. RETURN PISTOL.—The commands are: 1. RETURN, 2. PISTOL. At the command PISTOL, lower the pistol to the holster, reversing it, muzzle down, back of the hand to the right; raise the flap of the holster with the right thumb; insert the pistol in the holster and thrust it home; button the flap of the holster with the right hand.

#### MOUNTED

■ 76. GENERAL RULES.—The following movements are executed as when dismounted: RAISE PISTOL, RETURN PISTOL, CLOSE CHAMBER. The mounted movements may be practiced when dismounted by first cautioning, "Mounted position." The right foot is then carried 20 inches to the right and the left hand to the position of the bridle hand. Whenever the pistol

is lowered into the bridle hand, the movement is executed by rotating the barrel to the right. Grasp the slide in the full grip of the left hand, thumb extending along the slide, back of the hand down, barrel down and pointing upward and to the left front.

■ 77. WITHDRAW MAGAZINE.—Lower the pistol into the bridle hand. Press the magazine catch with the forefinger of the right hand, palm of the hand over the base of the magazine to prevent it from springing out; withdraw the magazine and place it in the belt or pocket.

■ 78. OPEN CHAMBER.—Withdraw the magazine. Grasp the stock with the right hand, back of the hand down, thrust forward and upward with the right hand, and engage the slide stop by pressure of the right thumb.

■ 79. INSERT MAGAZINE.—Lower the pistol into the bridle hand. Extra magazines should be carried in the belt with the projection on the base pointing to the left. Grasp the magazine with the tip of the right forefinger on the projection, withdraw it from the belt, and insert it in the pistol. Press it fully home.

■ 80. LOAD PISTOL.—The commands are: 1. LOAD, 2. PISTOL. At the command PISTOL, lower the pistol into the bridle hand. If a loaded magazine is not already in the pistol, insert one. Grasp the stock with the right hand, back of the hand down, and thrust upward and to the left front; release the slide and engage the safety lock.

■ 81. UNLOAD PISTOL.—The commands are: 1. UNLOAD, 2. PISTOL. At the command PISTOL, withdraw the magazine. Open the chamber. Glance at the chamber to verify that it is empty. Close the chamber. Take the position of RAISE PISTOL and squeeze the trigger. Then insert an empty magazine.

■ 82. INSPECT PISTOL.—The commands are: 1. INSPECTION, 2. PISTOL. (The pistol is inspected mounted only at mounted guard mounting. The magazine is not withdrawn.) At the command PISTOL, take the position of RAISE PISTOL. After the pistol has been inspected, or on command, it is returned.

## SECTION VI

## MANUAL OF THE GUIDON

■ 83. GENERAL.—The guidon is a company identification flag. It is carried at ceremonies and when prescribed by the commander. In camp it is displayed at the company headquarters. In combat it is with the company baggage. The guidon bearer is a specially selected enlisted man designated by the company commander.

## DISMOUNTED

■ 84. GENERAL RULES.—The guidon is brought to PRESENT ARMS, PARADE REST, and to the ORDER with the company. At the command of execution of other movements of the manual, the guidon is brought to the CARRY except for the execution of the manual at parades. When executing the FACINGS, SIDE STEP, and ALINEMENTS, the guidon is held at CARRY GUIDON. When marching at ROUTE STEP or at ease the guidon is at the CARRY, the lance held by either hand. When at the ORDER, unless otherwise prescribed, the guidon is brought to the CARRY at the command of execution for marching in quick time.

■ 85. CARRY GUIDON.—The lance of the guidon is held vertically in the right hand, resting in the hollow formed by the thumb and first finger, back of the hand to the right, arm extending downward, lance resting in the hollow of the shoulder, ferrule 6 inches from the ground as shown in figure 17. The CARRY is the habitual position when troops are marching.

■ 86. BEING AT ORDER GUIDON, EXECUTE CARRY GUIDON.—Grasp the lance with the left hand at the same time loosening the grip of the right hand on the lance. Raise the guidon vertically with the left hand, the lance sliding through the right hand until the ferrule is 6 inches from the ground, then regrasp the lance with the right hand. Cut the left hand away smartly to the left side.

■ 87. BEING AT CARRY GUIDON, EXECUTE ORDER GUIDON.—Allow the lance to slide through the right hand until the ferrule is on the ground on line with and touching the toe

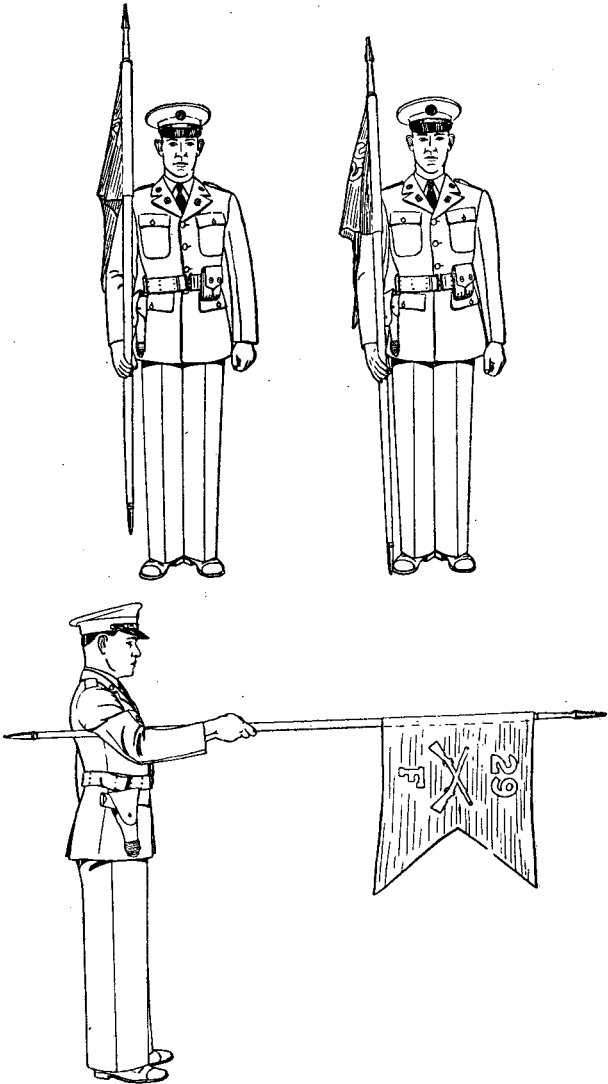

FIGURE 17.—Manual of the guidon.

of the right shoe, right hand grasping the lance as in the CARRY.

■ 88. BEING AT ORDER GUIDON, EXECUTE PARADE REST.—Execute in a manner similar to PARADE REST with the rifle.

■ 89. BEING AT CARRY OR ORDER GUIDON, EXECUTE PRESENT GUIDON.—*a.* Lower the guidon straight to the front, extending the right arm nearly horizontal until the lance, resting in the pit of the right arm, is horizontal. This movement is executed at the command of execution, ARMS, of 1. PRESENT, 2. ARMS.

*b.* In passing in review the guidon bearer executes EYES RIGHT and PRESENT GUIDON at the second movement of the company commander's saber salute (or at the first movement of his hand salute) and returns to FRONT and CARRY GUIDON at the last movement of the company commander's salute.

■ 90. BEING AT PRESENT GUIDON, EXECUTE CARRY GUIDON.—Grasp the lance with the left hand, palm up, at a point just beyond the right hand. With the left hand carry the guidon up and back to the position of CARRY GUIDON as shown in figure 17, at the same time the right hand, retaining its grasp on the lance, is lowered to the right side. Cut the left hand away smartly to the left side.

■ 91. BEING AT PRESENT GUIDON, EXECUTE ORDER GUIDON.—The manual is executed as prescribed in paragraph 90 except that when the guidon is brought to the vertical position, the lance is allowed, if necessary, to slide through the right hand, the left hand steadying the lance, until the guidon is in the position of ORDER GUIDON as shown in figure 17.

■ 92. INDIVIDUAL SALUTE BY GUIDON BEARER.—At the CARRY or ORDER, the salute is given with the left hand in the same manner as a rifle salute at order arms.

■ 93. DOUBLE TIME.—At double time, the guidon is held diagonally across the body, the right hand grasping the lance at the position used at the CARRY, right forearm horizontal, elbow near the body, left hand grasping the lance opposite the junction of the neck and left shoulder.



## MOUNTED

■ 94. GENERAL RULES.—When the guidon is carried mounted, the following modifications will prevail:

a. If leading the horse, the lance is held in the left hand in the same relative manner as in the CARRY, dismounted.

b. At STAND TO HORSE, the heel of the lance rests on the ground on line with and touching the toe of the left shoe, the lance being held with the left hand in the same relative manner as in the ORDER, dismounted.

c. At the command PREPARE TO MOUNT, the heel of the lance is raised slightly from the ground while stepping back; upon halting, the heel is placed on the ground 1 foot in front of the left forefoot of the horse; the left hand continues to grasp the lance as well as a lock of the mane.

d. After mounting, the lance is grasped with the right hand and is then raised over the reins and is lowered on the right side of the saddle, the heel of the lance being inserted in the guidon socket. The right arm is passed through the sling.

e. When mounted, the heel of the lance being in the guidon socket, the right hand grasps the lance, forearm nearly horizontal, the arm through the sling, lance vertical. This is the position of CARRY GUIDON, mounted, and is the habitual position of the guidon when the guidon bearer is mounted.

f. (1) PRESENT GUIDON and the RETURN TO THE CARRY are executed as from CARRY, dismounted, except that the left hand is not used in executing these movements.

(2) The individual salute is not rendered by a guidon bearer when mounted.

g. At the command PREPARE TO DISMOUNT, the arm is disengaged from the sling, the heel of the lance is disengaged from the guidon socket; the lance, slightly inclined to the rear, is carried over the reins, the lance lowered until its heel rests on the ground 1 foot in front of the left forefoot of the horse and the lance grasped jointly in the left hand with a lock of the mane. After dismounting, the position of stand to horse is assumed.

h. When the organization is marching at ROUTE STEP or AT EASE, the guidon may be carried at will with the spearhead elevated.

## SECTION VII

## MANUAL OF THE COLOR AND STANDARD

■ 95. USE AND CARE OF COLORS AND STANDARDS.—The following rules will govern the use and care of the colors and standards:

*a.* The national and regimental flags carried by dismounted organizations are called the national color and the regimental color. The term "color" implies the national color. The term "colors" implies both the national color and regimental color.

*b.* The national and regimental flags carried by mounted or motorized organizations are called the national standard and the regimental standard. The term "standard" implies the national standard. The term "standards" implies both the national standard and the regimental standard.

*c.* In garrison, the colors and standards when not in use are kept at the office or quarters of the commanding officer and are escorted thereto and therefrom by the color guard or standard guard. In camp the colors or standards when not in use are displayed in front of the commanding officer's tent. From reveille to retreat, when the weather permits, they are displayed uncased. From retreat and to reveille and during inclement weather, they are cased and placed in the commanding officer's office, quarters, or tent.

*d.* Colors and standards are cased when furled and placed within protective covering.

*e.* The colors and standards may be carried in any formation in which two or more companies participate, and in escorts when ordered.

*f.* In separate organizations and commands entitled to colors or standards and in battalions not stationed with their regimental headquarters, the colors and standards are similarly cared for and displayed at the office, quarters, or tent of the commanding officer.

*g.* Battalions and squadrons stationed with their regimental headquarters do not display the colors or standards of their organizations.

*h.* At regimental formations, the colors or standards are posted with the regiment. When the regimental formation is broken up, as at drill or field exercises, the colors or stand-

ards join the regimental commander or are dismissed as directed.

■ 96. SALUTES NOT RENDERED BY NATIONAL COLOR OR STANDARD.—The national color or standard renders no salute.

■ 97. SALUTES BY REGIMENTAL COLOR OR STANDARD.—*a.* The regimental color or standard salutes in all military ceremonies while the *National Anthem* or *To the Color* is being played and when rendering honors to its regimental commander or an individual of higher rank, but in no other case.

*b.* If marching, the regimental color or standard salutes when 6 paces from the person entitled to the salute and resumes the CARRY when 6 paces beyond him.

*c.* In passing in review the color or standard guard executes EYES RIGHT at the command of the senior color sergeant, who commands: 1. EYES, 2. RIGHT and 1. READY, 2. FRONT at the saluting distances prescribed in *b* above. The regimental color or standard also salutes (*a* above) at the command RIGHT and resumes the CARRY at the command FRONT. The man on the right flank does not execute EYES RIGHT. In those organizations which do not execute EYES RIGHT in passing in review, the standard guard omits this compliment. Where applicable, the regimental standard salutes at the command of the senior, who commands: 1. STANDARD, 2. SALUTE. The return to the CARRY is made at the command: 1. CARRY, 2. STANDARD.

■ 98. COLOR GUARD.—*a.* The color guard consists of two color sergeants who are the regimental color bearers, and two experienced privates selected by the regimental commander, usually for long and honorable service. A position on the color guard is one of honor and responsibility. The privates so designated, when not engaged in the performance of their duties as members of the color guard, join their organizations. The senior color sergeant carries the national color and commands the color guard. He gives the necessary commands for movements and for rendering honors, when present, otherwise the senior remaining member does so. The junior color sergeant carries the regimental color. The regimental color is always placed on the left of the national color in whatever direction they face.

*b.* When battalions carry the color, a battalion staff sergeant acts as color bearer, and two experienced privates are

selected by the battalion commander as members of the color guard. The general rules prescribed for the regimental color guard are applicable to the battalion.

c. The color guard is formed and marched in one rank at close interval, the color bearers in the center. The color guard does not execute TO THE REAR MARCH, ABOUT FACE, OR FIX BAYONETS. When the unit to which it is attached moves to the rear for short distances, the color guard, at the command of the senior color sergeant, executes COLUMN RIGHT (LEFT) twice, marches to the new line, again executes COLUMN RIGHT (LEFT) twice, and halts in its proper place.

d. At the command of the senior color sergeant, the privates of the color guard PRESENT ARMS or, if armed with the pistol, execute the HAND SALUTE on receiving and parting with the colors. After having parted with the colors, the guard is brought to ORDER ARMS by command of the senior remaining member who is placed as right man of the guard.

e. Having received the colors, the senior sergeant conducts the guard to its proper position before the color company, as outlined in *f* below. Having parted with the colors, the guard is dismissed by the senior sergeant.

*f.* At drills and ceremonies in which the colors are to participate, except escort of the color, the colors are received by the color company prior to the formation of the battalion with the following ceremony: the color company is formed, its company commander facing the front. The color guard, conducted by the senior sergeant, approaches from the front and halts at a distance of 10 paces from the company commander. The company commander then faces about, brings the company to the PRESENT, faces to the front, salutes, again faces about, and brings the company to the ORDER. The privates of the color guard execute PRESENT and ORDER ARMS with the color company. The color guard is then marched by the senior color sergeant directly to its post, as indicated. When the color company joins the battalion, the color guard takes its appropriate post in the battalion formation. When the color battalion joins the regiment, the color guard takes its appropriate post in the regimental formation. When the color joins the color company, it takes post on the left when the company is in line or mass and in rear when it is in column.

*g.* When it is desired to dismiss the color guard at the conclusion of a drill or ceremony in which the colors have participated, the color guard proceeds from its position and halts 10 paces in front of and facing the company commander of the color company. The company commander then faces about, brings the company to the PRESENT, faces to the front, salutes, again faces about, and brings the company to the ORDER. The privates of the color guard execute PRESENT and ORDER ARMS with the color company. The color guard then escorts the colors to the office, quarters, or tent of the commanding officer. The color guard is dismissed from organizations smaller than a company (funeral escort) in a similar manner.

*h.* In campaign, prior to engagement of the regiment and upon direction of the commanding officer, the colors are stored with the regimental baggage under guard of one color sergeant. The other color sergeant remains with regimental headquarters.

■ 99. POSITION OF COLOR AT ORDER.—At the ORDER, the heel of the pike rests on the ground on line with and touching the toe of the right shoe. The right hand at a convenient place on the pike clasps it with the thumb, back of the hand to the right, and holds it in a vertical position.

■ 100. POSITION OF COLOR AT CARRY.—At the CARRY, the heel of the pike rests in the socket of the sling; the right hand grasps the pike at the height of the shoulder; the pike is inclined slightly to the front.

■ 101. POSITION OF COLOR AT PARADE REST.—*a.* PARADE REST with the color is similar to PARADE REST with the rifle, except that the pike is kept vertical.

*b.* The ORDER is resumed at the command ATTENTION.

*c.* The ORDER and PARADE REST are executed with the color company.

■ 102. POSITION OF REGIMENTAL COLOR AT COLOR SALUTE.—This position is assumed from the CARRY by slipping the right hand up the pike to the height of the eye, then lowering the pike by straightening the arm to the front. When the regimental color salutes with troops who execute PRESENT ARMS from the order, the position of CARRY is assumed at the command ARMS and the COLOR SALUTE executed.

■ 103. POSITION OF COLORS DURING MANUAL OF ARMS.—The colors habitually remain at the ORDER during the execution of the manual of arms.

## SECTION VIII

## MANUAL OF THE SABER

■ 104. GENERAL.—*a.* For garrison service, officers and warrant officers are equipped with the officer's saber. The saber is not carried in the field.

*b.* Dismounted, the scabbard is carried on the left side attached to the belt by the saber sling or chain and hooked to the belt by means of the upper ring, guard of the saber to the rear.

*c.* Mounted, the scabbard is carried in the saber carrier attached to the off side of the cantle of the saddle, guard of the saber to the rear.

*d.* Officers of a commander's staff draw and return saber with him.

*e.* The position of ORDER SABER is assumed by dismounted officers when in formation at attention, except as otherwise provided in *f*, *g*, *h*, and *i* below.

*f.* The position of CARRY SABER is assumed—

- (1) To give commands.
- (2) To change position at quick time.
- (3) When officially addressing or when officially addressed by another officer, if saber is drawn.
- (4) Preparatory to returning saber.
- (5) At the preparatory command for and while marching in quick time.

*g.* The position of PRESENT SABER is assumed—

- (1) To salute when the saber is drawn.
- (2) In executing PRESENT ARMS when the unit is presented to the colors, to any person, or when the *National Anthem* is played.
- (3) In executing EYES RIGHT (OR LEFT) when marching past a reviewing officer or stand, officers armed with the saber who are in the interior of a mass formation do not execute PRESENT SABER.

*h.* The position of PORT SABER is assumed when marching in double time.

*i.* The position of the saber at PARADE REST is assumed by dismounted officers whenever the unit executes PARADE REST.

*j.* Mounted officers do not execute ORDER SABER, PORT SABER, or PARADE REST.

*k.* The manual of the saber is executed without command except for saber drill.

*l.* The saber may be carried in the scabbard while marching AT EASE or at ROUTE STEP.

#### DISMOUNTED

■ 105. DRAW SABER.—*a.* The commands are: 1. DRAW, 2. SABER.

(1) At the command DRAW, unhook the saber with the thumb and first fingers of the left hand, thumb on the end of the hook, fingers lifting the upper ring. Grasp the scabbard with the left hand at the upper band and bring the hilt of the saber a little forward, guard down, blade inclined downward to the rear at an angle of 45°. Grasp the hilt in

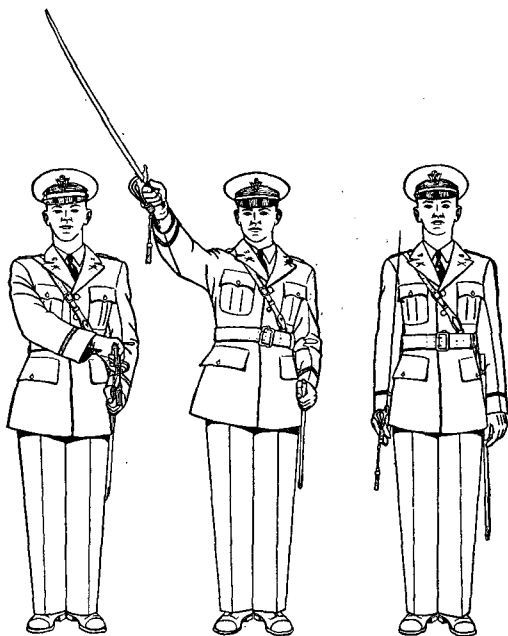

FIGURE 18.—Draw saber

the right hand, press the left hand against the left thigh and draw the saber 6 inches from the scabbard.

(2) At the command **SABER**, draw the saber smartly, raising the arm to its full extent to the right front at an angle of  $45^{\circ}$  with the horizontal, edge down, in prolongation of the arm. Make a slight pause and bring the saber down so that the back of the blade is against the point of the shoulder, edge to the front, arm nearly extended, elbow back, the grip clasped easily between the first and second fingers and the thumb, the third and fourth fingers back of the grip. At the same time, hook up the scabbard with the thumb and first two fingers of the left hand, thumb through the upper ring, fingers supporting it. Drop the left hand by the side. This is the position of **CARRY SABER, dismounted**.

b. Members of dismounted organizations will not engage the wrist in the saber knot except when they intend to publish orders, call the roll, etc.

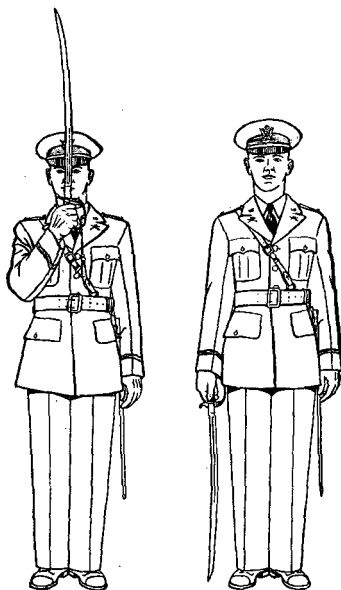

FIGURE 19.—Present saber.



■ 106. PRESENT SABER.—*a.* The commands are: 1. PRESENT, 2. SABER.

(1) At the command PRESENT, raise and move the saber to the front, base of the hilt as high as and 3 inches in front of the chin, edge to the left, point 6 inches farther to the front than the hilt, thumb extended on the left of the grip, all fingers grasping the grip.

(2) At the command SABER, lower the saber smartly until the point is in prolongation of the right foot and near the ground, edge to the left, hand by the side, thumb on the left of the grip, arm extended. If marching, the arms swing naturally.

*b.* PRESENT SABER is executed when 6 paces from the person saluted or at the point of nearest approach if more than 6 paces. The second position is held until the person saluted has passed or the salute has been returned. In passing in review, salutes are rendered and EYES RIGHT executed when the leading element of the unit which is to execute EYES RIGHT on command is 6 paces from a point directly opposite the reviewing officer. The second position is held until a point 6 paces beyond the reviewing officer is passed by the rear-most element of that unit.

*c.* For action of commanders and staff see paragraph 234*g*.

*d.* From PRESENT SABER the position of CARRY is assumed in two counts in the cadence of quick time. The first count brings the saber to the ORDER, the second count to the CARRY.

■ 107. RETURN SABER.—When practicable, RETURN SABER should be executed at the halt. The commands are: 1. RETURN, 2. SABER. At the command RETURN, carry the right hand opposite to, and 6 inches in front of, the left shoulder, saber vertical, edge to the left. At the same time unhook and lower the scabbard with the left hand and grasp it at the upper band. At the command SABER, drop the point to the rear by turning the right hand as shown in figure 20, or in the most convenient manner as the design of the saber permits. Turn the head slightly to the left, fixing the eyes on the opening of the scabbard, raise the right hand sufficiently to insert the blade and return it. Turn the head to the front and drop the right hand by the side. Hook up the scabbard with the left hand and drop the left hand by the side.

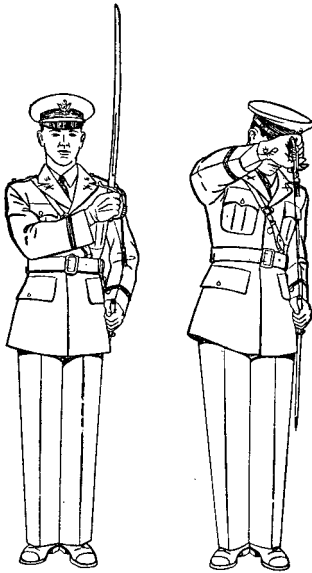

FIGURE 20.—Return saber.

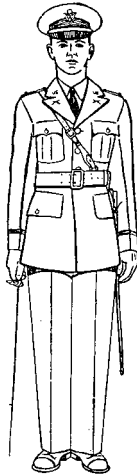

FIGURE 21.—Order saber.

■ 108. ORDER SABER.—The commands are: 1. ORDER, 2. SABER.

*a.* Being at CARRY SABER, at the command SABER, drop the point of the saber directly to the front, point near the ground, edge down, thumb along the back of the grip.

*b.* Being at PRESENT SABER, at the command SABER, bring the saber to the position of order by turning the hand to the left.

■ 109. PARADE REST.—Being at ORDER SABER, the commands are: 1. PARADE, 2. REST. At the command REST, move the left foot 12 inches to the left of the right foot, keeping the legs straight, so that the weight of the body rests equally on both feet. Place the left hand behind the body, resting in the small of the back, palm to the rear. At the command ATTENTION, resume the position of attention.

■ 110. PORT SABER.—The commands are: 1. PORT, 2. SABER. At the command SABER, the saber is carried diagonally across the breast, edge to the front, right hand at the height of the waist and in front of the right hip, left hand steadying the scabbard.



FIGURE 22.—Parade rest.



FIGURE 23.—Port saber.

## MOUNTED

■ 111. **DRAW SABER.**—At the command **DRAW**, insert the hand through the saber knot, and execute the same movements as when dismounted, except that the left hand is not used. At the command **SABER**, execute the same movements as when dismounted, except that at **CARRY SABER**, mounted, the right hand rests on the thigh.

■ 112. **PRESENT SABER.**—Execute at the same command and in the same manner as when dismounted, except that the point of the saber is lowered to the level and a little to the

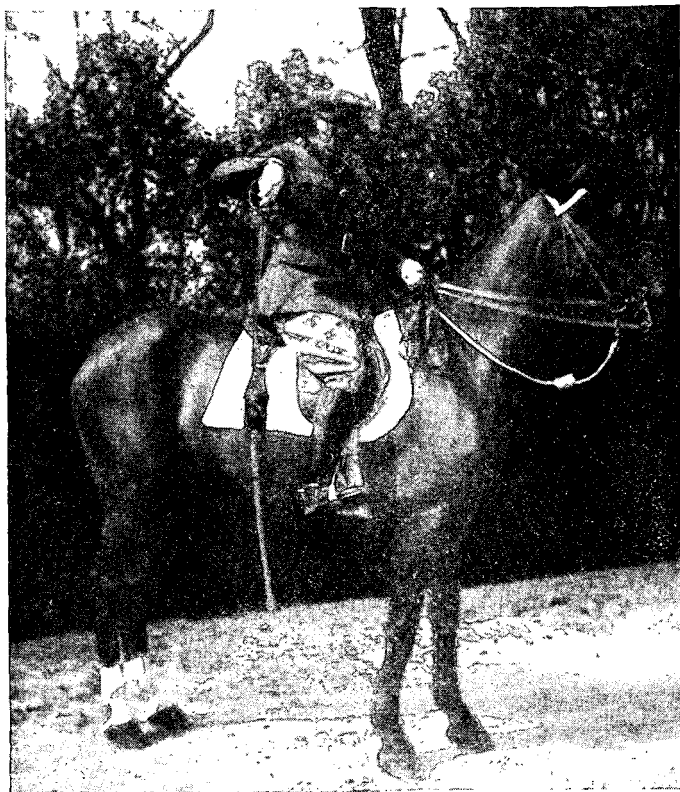

FIGURE 24.—Return saber, mounted.

front and right of the stirrup. The right hand is slightly in rear of the thigh.

■ 113. **RETURN SABER.**—At the command **RETURN**, carry the hand to a position the height of and 6 inches in front of the right shoulder, the blade vertical, edge to the front, the grip grasped so that the pommel rests in the hollow of the hand. At the command **SABER**, turn the head and eyes toward the scabbard, raise the right hand vertically to the full extent of the arm, lower the blade, and return the saber as shown in figure 24. Disengage the wrist from the saber knot and resume the position of attention.

## CHAPTER 4

### DRILL FOR FOOT TROOPS

SECTION		Paragraphs
I.	Squad .....	114-130
II.	Platoon .....	131-146
III.	Company .....	147-158

#### SECTION I

#### SQUAD





■ 114. **GENERAL.**—*a.* The squad is a group of soldiers organized primarily as a combat team. It consists of one squad leader and other personnel as authorized by appropriate Tables of Organization. When the squad leader is absent, he is replaced by the second in command. If the second in command is also absent, the next senior member of the squad acts as leader.

*b.* As far as practicable, the squad is kept intact. The normal formation of the squad is a single rank or single file. This permits variation in the number of men composing the squad.

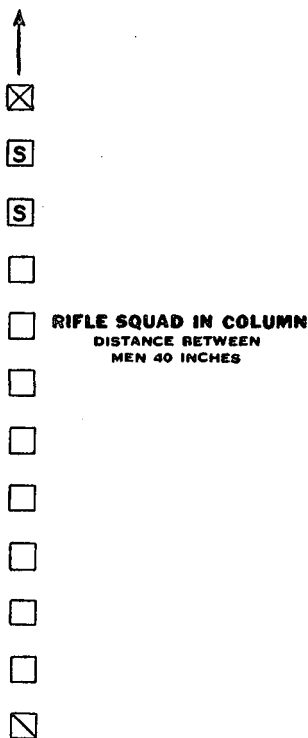
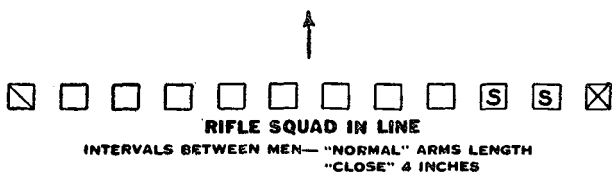
*c.* The squad in line marches to the left or to the front only for minor changes of position.

■ 115. **FORM SQUAD.**—*a.* The command is: **FALL IN**. At the command **FALL IN**, the squad forms in line as shown in figure 27. On falling in, each man except the one on the left extends his left arm laterally at shoulder height, palm of the hand down, fingers extended and joined. Each man, except the one on the right, turns his head and eyes to the right and places himself in line so that his right shoulder touches lightly



-  SQUAD LEADER
-  SECOND IN COMMAND
-  RIFLEMAN
-  SCOUT

① Rifle squad.

FIGURE 25.—Squad.

the tips of the fingers of the man on his right. As soon as proper intervals have been obtained, each man drops his arm smartly to his side and turns his head to the front.

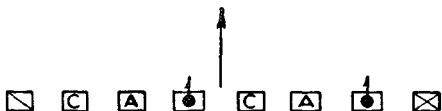

**AUTOMATIC RIFLE SQUAD IN LINE**  
 INTERVALS BETWEEN MEN: "NORMAL"—ARMS LENGTH  
 "CLOSE"—4 INCHES

**LEGEND**

☒ SQUAD LEADER

☐ C SECOND IN COMMAND

☐ ● ↑ AUTOMATIC RIFLEMAN

☐ A ASSISTANT  
 AUTOMATIC RIFLEMAN

☐ C AMMUNITION CARRIER



**AUTOMATIC RIFLE SQUAD IN COLUMN**

DISTANCE BETWEEN MEN:— 40 INCHES

② Automatic rifle squad.

FIGURE 25.—Squad—Continued.

*b.* To form at close intervals, the commands are: 1. AT CLOSE INTERVAL, 2. FALL IN. At the command FALL IN, the men fall in as in *a* above, except that close intervals are obtained by placing the left hands on the hips as shown in

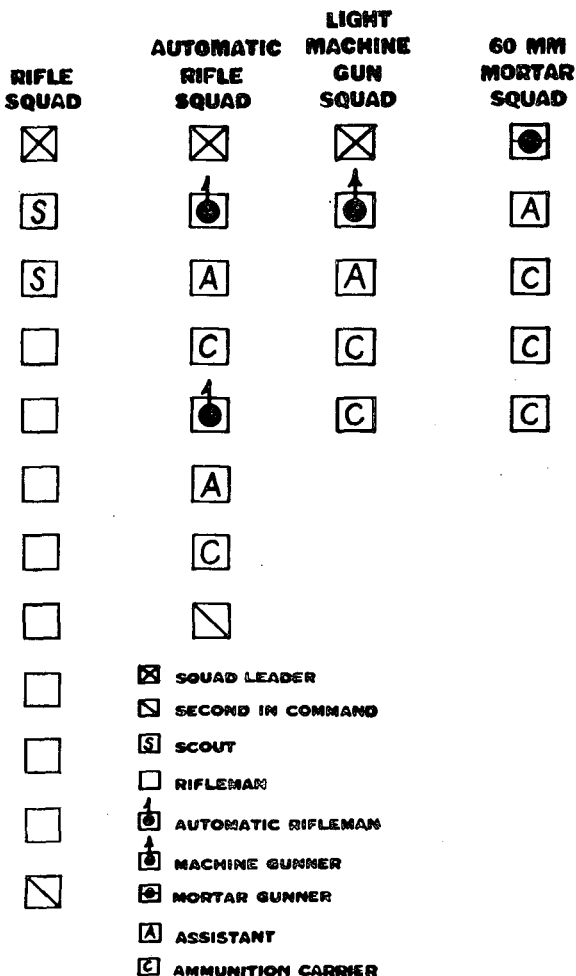

FIGURE 26.—Details of infantry rifle company squads.



figure 28. In this position the heel of the palm of the hand rests on the hip, the fingers and thumb are extended and joined, and the elbow is in the plane of the body.

[c. The squad falls in on the squad leader. If the squad is [formed under arms, pieces are at once inspected.

■ 116. PREVIOUS INSTRUCTIONS APPLICABLE.—The squad executes the positions, movements, and manual of arms as prescribed in chapters 2 and 3, all men executing the movements simultaneously.

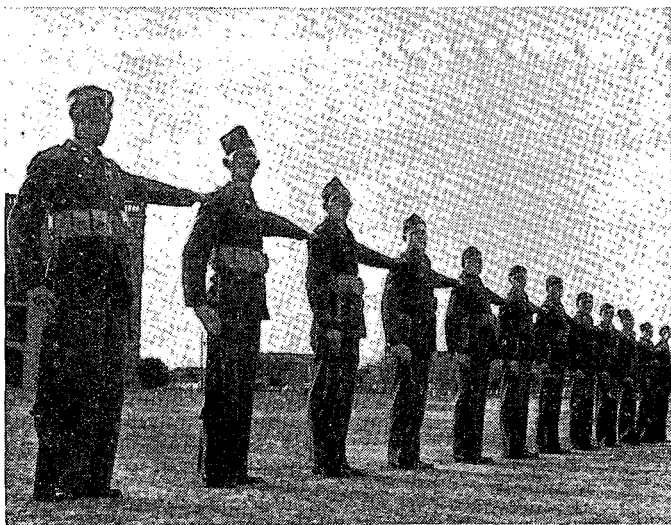

FIGURE 27.—FALL IN.

■ 117. DISMISS SQUAD.—The commands are: 1. INSPECTION, 2. ARMS, 3. PORT, 4. ARMS, 5. DISMISSED, or 3. UNLOCK PIECES, 4. DISMISSED (if armed with the M1 rifle).

■ 118. COUNT OFF.—a. The command is: COUNT OFF. At the command COUNT OFF, each man of the squad, except the one on the right flank, turns his head and eyes to the right. The right flank man calls out, "One." Each man in succession calls out, "Two," "Three," etc., turning his head and eyes to the front as he gives his number.

b. This command may be given whenever it is desired that the men know their relative positions in the squad.



FIGURE 28.—1. AT CLOSE INTERVAL, 2. FALL IN.

■ 119. **ALINE SQUAD.**—*a.* If in line, the commands are: 1. **DRESS RIGHT (LEFT)**, 2. **DRESS**, 3. **READY**, 4. **FRONT**. At the command **DRESS**, each man except the one on the left extends his left arm (or if at close interval, places his left hand upon his hip), and all aline themselves to the right. The instructor places himself on the right flank 1 pace from and in prolongation of the line and facing down the line. From this position he verifies the alinement of the men, ordering individual men to move forward or back as is necessary. Having checked the alinement, he faces to the right in marching and moves 3 paces forward, halts, faces to the left and commands: 1. **READY**, 2. **FRONT**. At the command **FRONT**, arms are dropped quietly and smartly to the side and heads turned to the front.

*b.* If in column the command is: **COVER**. At the command **COVER**, men cover from front to rear with 40 inches distance between men.

■ 120. BEING IN LINE AT NORMAL INTERVAL, OBTAIN CLOSE INTERVAL.—The commands are: 1. CLOSE, 2. MARCH. At the command MARCH, all men except the right flank man face to the right in marching and form at close interval as prescribed in paragraph 115*b*.

■ 121. BEING IN LINE AT CLOSE INTERVAL, EXTEND TO NORMAL INTERVAL.—The commands are: 1. EXTEND, 2. MARCH. At the command MARCH, all men except the right flank man face to the left in marching and form at normal interval as prescribed in paragraph 115*a*.

■ 122. BEING IN LINE, MARCH TO FLANK.—The commands are: 1. RIGHT (LEFT), 2. FACE, 3. FORWARD, 4. MARCH. The movements are executed as explained in paragraphs 19*a* and 22, all men stepping off simultaneously.

■ 123. MARCH TO OBLIQUE.—*a*. For the instruction of recruits, the squad being in column or correctly alined, the instructor causes each man to face half right (left), points out his position, and explains that it is to be maintained in the oblique march.

*b*. The squad being in any formation, the commands are: 1. RIGHT (LEFT) OBLIQUE, 2. MARCH. At the command MARCH, given as the right foot strikes the ground, each individual advances and plants the left foot, faces half right in marching and steps off in a direction of 45° to the right of his original front. He preserves his relative position, keeping his shoulders parallel to those of the guide (man on right front of line or column), and so regulates his step that the ranks remain parallel to their original front.

*c*. The command HALT is given on the left foot when halting from the right oblique and on the right foot when halting from left oblique. At the command HALT, given as the left foot strikes the ground, each individual advances and plants the right foot, turns to the front on the ball of the right foot, and places the left foot by the side of the right foot.

*d*. To resume the original direction, the commands are: 1. FORWARD, 2. MARCH. At the command MARCH, each individual faces half left in marching and then moves straight to the front.

*e*. If at HALF STEP OR MARK TIME while obliquing, the FULL STEP is resumed by the command: 1. OBLIQUE, 2. MARCH.

*f.* To give volume to the command the word "oblique" is pronounced to rhyme with "strike."

■ 124. MARCH TOWARD FLANK WHILE IN MARCH.—*a.* The commands are: 1. BY THE RIGHT (LEFT) FLANK, 2. MARCH. At the command MARCH, each individual executes the movement as prescribed in paragraph 30.

*b.* This movement is used when a quick movement to the right or left for a short distance is required. Normally the unit is halted, faced in the desired direction, and started forward again by the commands: 1. FORWARD, 2. MARCH.

■ 125. BEING IN COLUMN, CHANGE DIRECTION.—The commands are: 1. COLUMN RIGHT (LEFT) (HALF RIGHT) (HALF LEFT), 2. MARCH. At the command MARCH, the leading man executes the movement as prescribed in paragraph 29*a* or *b*. The other men in the column execute the same movement successively and on the same ground as the leading man.

■ 126. BEING IN LINE, TAKE INTERVAL AND ASSEMBLE.—*a.* To take interval, the commands are: 1. TAKE INTERVAL TO THE LEFT (RIGHT), 2. MARCH. At the command MARCH, the right flank man stands fast and extends his left arm at shoulder height, palm of the hand down, fingers extended and joined until the man on his left obtains the proper interval, then he drops his arm. Other men face to the left in marching and step out until they have an interval of two arms' length from the man on their right. Each man, except the one on the left who raises his right arm only, extends both arms laterally at shoulder height. Each man, except the right flank man, then turns his head and eyes to the right and places himself in line so that the finger tips of his right hand touch lightly the finger tips of the left hand of the man on his right. As soon as each man alines himself at two arms' length intervals from the man on his right, he drops his right arm to the side and turns his head and eyes to the front. He drops his left arm to the side when the man on his left has obtained his proper interval. If under arms, rifles will be slung prior to the execution of this movement.

*b.* To assemble, the commands are: 1. ASSEMBLE TO THE RIGHT (LEFT), 2. MARCH. At the command MARCH, the right flank man stands fast. All other men face to the right in marching and form at normal intervals as in paragraph 115*a*.

**127. STACK ARMS.—a.** The rifle squad being in line at normal or close interval, the commands are: 1. STACK, 2. ARMS. Numbers 2, 5, 8, and 11 make the stacks except when no men are on the left of these numbers. The stack is made as follows: At the command ARMS, the man on the left of the stackman regrasps his rifle with his right hand at the balance, carrying it to the horizontal position, barrel up, and passes his rifle to the stackman who grasps it with his left hand between the upper sling swivel and stacking swivel and places the butt between his feet, barrel to the front, muzzle inclined slightly to the front, the thumb and forefinger raising the stacking swivel. The stackman then throws the butt of his own rifle 2 feet in advance of that of his left file and 6 inches to the right of his right toe; at the same time he allows his right hand to slip to the stacking swivel and engages his rifle with that of his left file. The man on the right of the stackman raises his rifle with his right hand, regrasps it with his right hand at the balance, steps to the left front keeping his right foot in place, and carries his rifle well forward, barrel to the front; the left hand guiding the stacking swivel engages the lower hook of the swivel of his own rifle with the free hook of that of his left file, and then turns the barrel outward into the angle formed by the other two rifles and lowers the butt to the ground so that it will form a uniform stack with the other two rifles. He then assumes the position of attention. Other rifles of the squad are passed toward the nearest stack and laid on the stack by the stackman.

**b.** The automatic rifle squad, rifle company, being in line at normal or close interval, the commands are: 1. STACK, 2. ARMS. The second man from the left makes the stack. The stack is made as follows: At the command ARMS, the man on the left of the stackman regrasps his rifle with the right hand at the balance, carrying it to the horizontal position, barrel up, and passes his rifle to the stackman who grasps it with his left hand between the upper sling swivel and stacking swivel and places the butt between his feet, barrel to the front, muzzle inclined slightly to the front, the thumb and forefinger raising the stacking swivel. The stackman then throws the butt of his own rifle 2 feet in advance of that of his left file and 6 inches to the right of his right toe; at the same time he allows his right hand to slip to the stacking swivel and engages his rifle with that of his left file.

The nearest rifle on the right is then passed to the man on the right of the stackman who raises the rifle with his right hand at the balance, steps to the left front keeping his right



①

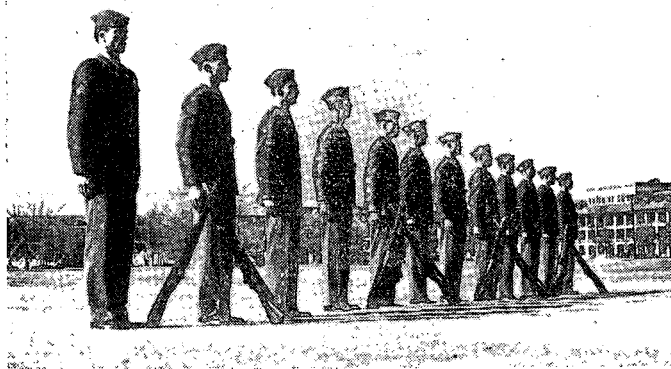

②

FIGURE 29.—Stack arms, rifle squad.

foot in place, and carries the rifle well forward, barrel to the front; the left hand guiding the stacking swivel engages the lower hook of the swivel of the rifle with the free hook of

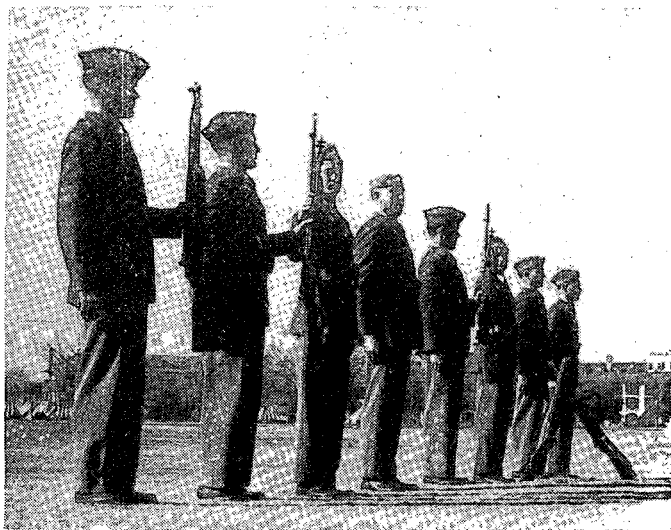

【①】

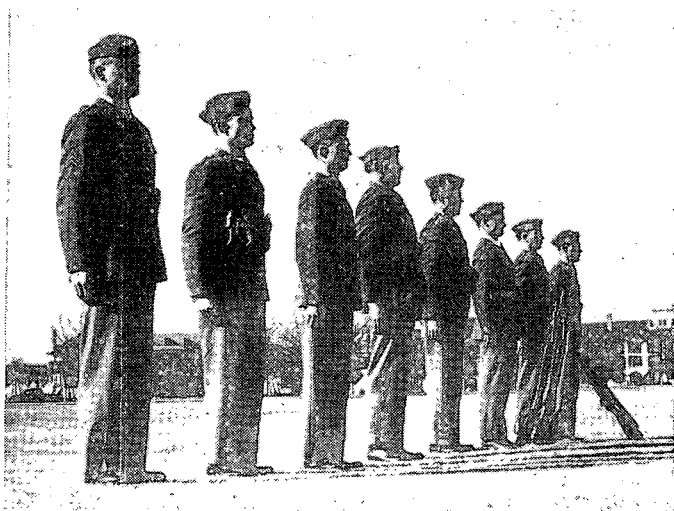

【②】

【FIGURE 30.—Stack arms, automatic rifle squad.

[that of the stackman, and then turns the barrel outward into the angle formed by the other two rifles and lowers the butt to the ground so that it will form a uniform stack with the other two rifles. He then assumes the position of attention. Automatic rifles and the other rifle of the squad as passed toward the stack and laid on the stack by the stackman.

[c. The rifle squad of the antitank company and other types of squads in general stack arms with the methods prescribed in *a* and *b* above.

■ 128. TAKE ARMS.—The squad being in line behind the stacks, the commands are: 1. TAKE, 2. ARMS. At the command ARMS, the procedure of stacking arms is reversed. The loose rifles are first passed back. In breaking the stack, the stackman grasps his rifle and that of the man on his left, so that the rifles will not fall when the man on the right raises and disengages his rifle. Each man, as he receives his rifle, resumes the position of ORDER ARMS.

■ 129. COLUMN OF TWOS.—When marching small groups not at drill, the group may be marched in column of twos by forming it in two ranks and giving the command: 1. RIGHT (LEFT), 2. FACE.

■ 130. FORM COLUMN OF TWOS FROM SINGLE FILE AND REFORM.—*a*. The squad being in column at a halt, to form column of twos the commands are: 1. FORM COLUMN OF TWOS, 2. MARCH. At the command MARCH, the leading man stands fast; the second man in the squad moves by the oblique until he is to the left of and abreast of the corporal with normal interval, and halts; the third man moves forward until behind the corporal with normal distance and halts; the fourth man moves by the oblique until he is to the left of and abreast of the third man with normal interval, and halts; and so on.

*b*. The squad being in column of twos, in marching to re-form single file, the squad is first halted. The commands are: 1. FORM SINGLE FILE FROM THE RIGHT, 2. MARCH. At the command MARCH, the leading man of the right column moves forward, the leading man of the left column steps off to the right oblique, then executes LEFT OBLIQUE so as to follow the right file at normal distance. Remaining twos follow successively in like manner.



## SECTION II

## PLATOON

■ 131. FORMATIONS OF MORE THAN ONE SQUAD.—*a.* The squads form in line, one behind the other, with 40 inches distance between ranks.

*b.* Squads are usually arranged to produce a three- or four-rank formation so that by facing to the right the unit will march in column of threes or column of fours depending on the number of squads.

*c.* A two-squad unit forms in two ranks and marches in column of twos.

*d.* A three-squad unit forms in three ranks and marches in column of threes.

*e.* A four-squad unit forms in four ranks and marches in column of fours.

*f.* A platoon composed of two sections of two squads each forms in four ranks and marches in column of fours.

*g.* Movements are described herein for COLUMN OF THREES or FOURS and may be executed by either formation.

*h.* When in line, the platoon is alined as prescribed for the squad in paragraph 119. The alinement of each rank is verified by the platoon leader.

*i.* The platoon being in line takes interval and assembles as prescribed for the squad in paragraph 126. This movement may be ordered after ranks are opened for the display of field equipment or for other special purpose. It is not utilized in forming for physical training.

*j.* The platoon is ordinarily formed for physical training from column of threes or fours in accordance with the commands and method prescribed in paragraph 18, FM 21-20. The extension to the left is executed on the right squad of the column which stands fast. The even-numbered men in all squads are designated to uncover.

■ 132. COMPOSITION AND FORMATION OF PLATOON.—The platoon consists of platoon headquarters and several squads. Platoon headquarters consists of a platoon leader and one or more assistants. For purposes of drill and ceremonies, a three-squad or four-squad formation should be arranged and the size of the squads equalized. Figure 31 shows how the platoon

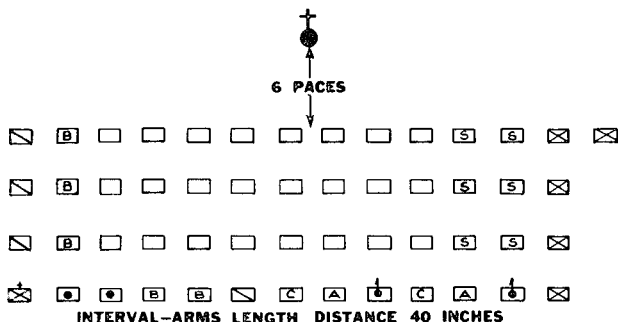

**RIFLE PLATOON IN LINE**

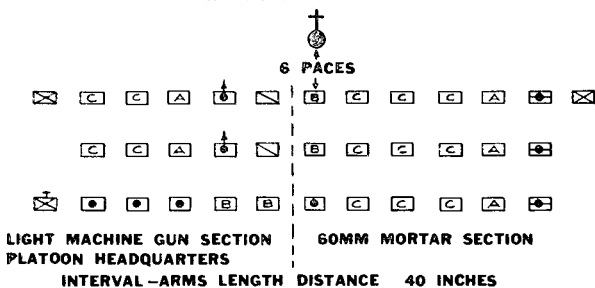

**WEAPONS PLATOON OF A RIFLE COMPANY IN LINE.**

**LEGEND**

- |                    |                        |
|--------------------|------------------------|
| ● PLATOON LEADER   | □ RIFLEMAN             |
| ⊕ PLATOON SERGEANT | ⊕ AUTOMATIC RIFLEMAN   |
| ⊗ SECTION LEADER   | ⊕ LIGHT MACHINE GUNNER |
| ⊗ PLATOON GUIDE    | ⊕ 60MM MORTAR GUNNER   |
| ⊗ SQUAD LEADER     | △ ASSISTANT GUNNER     |
| ⊗ CORPORAL         | □ AMMUNITION CARRIER   |
| ⊗ SCOUT            | ⊕ MESSENGER            |

⊗ BASIC

FIGURE 31.—Platoon formation

Formation applies to a rifle platoon and to the weapons platoon of a rifle company.

■ 133. POSITION OF INDIVIDUALS.—*a.* The platoon leader takes position 6 paces in front of the center of his platoon when in line. In march formation (column of threes or fours), he marches at the head of his platoon as shown in figure 32.

*b.* The second in command of a platoon takes position on the left of the left man of the rear rank when squads are in line unless otherwise indicated. When squads are in column, he follows the rear man in the right squad of the unit. The second in command observes the conduct of the unit, sees that the proper formation is maintained, and that commands are promptly and properly executed. The platoon guide (a sergeant or other specially designated noncommissioned officer) is posted on the right of the right flank man of the front rank when in line. In column, he takes post in front of the right flank man. He is responsible for maintaining the proper direction and cadence of march of the platoon.

*c.* Other noncommissioned officers (such as mess and supply sergeants, clerks, etc.) and privates (such as cooks, armorers, etc.), when attached to the platoon, fall in on the left when in line (or in rear when squads are in column) and march as part of regularly organized squads.

■ 134. FORM PLATOON.—*a.* The command is: FALL IN. At the command FALL IN, the first squad forms in line as prescribed in paragraph 115*a*, its center opposite and 3 paces from the platoon sergeant. The other squads form in rear of the first squad and in the same manner, with 40 inches distance between ranks. Members of the rear squads extend their arms to obtain their approximate intervals but cover the corresponding members in the first squad. The guide places himself as shown in figure 31.

*b.* To form with close interval, the commands are: 1. AT CLOSE INTERVAL, 2. FALL IN. At the command FALL IN, the movement is executed as prescribed in *a* above except that squads form at close interval (par. 115*b*).

*c.* The platoon is ordinarily formed and dismissed by the platoon sergeant (see also par. 149).

■ 135. DISMISS PLATOON.—The commands are: 1. INSPECTION, 2. ARMS, 3. PORT, 4. ARMS, 5. DISMISSED, or 3. UNLOCK PIECES, 4. DISMISSED (if armed with the M1 rifle).

■ 136. MARCH PLATOON.—*a.* The normal formation for marching is in column of threes (or fours) with squad columns abreast, squad leaders at the head of their squads.

*b.* The platoon in line marches to the left or to the front only for minor changes of position.

*c.* The platoon being in line to march to the right, the commands are: 1. RIGHT, 2. FACE, 3. FORWARD, 4. MARCH. This marches the platoon in column of threes (or fours) to the right.

■ 137. GUIDE IN MARCHING.—Except when otherwise directed, men in ranks keep the proper distance and interval and aline themselves on the men toward the flank on which the guide is marching. When it is desired to guide toward the left, the command is: GUIDE LEFT. The guide and the platoon leader then change their relative positions.

■ 138. BEING IN COLUMN OF THREES (OR FOURS) AT NORMAL INTERVAL BETWEEN SQUADS, MARCH (OR FORM) AT CLOSE INTERVAL.—*a.* The commands are: 1. CLOSE, 2. MARCH. At the command MARCH, the squads close to the center by obliquing until the interval between men is 4 inches. The center squad (or squads) take up the half step until the dress has been regained. The distance, 40 inches, remains unchanged.

*b.* If this movement is executed from the halt, the squads close toward the center by executing RIGHT or LEFT STEP until 4-inch intervals are reached. If in column of threes, the [right and left squads LEFT and RIGHT STEP two steps. If in [column of fours, the right center and left center squads LEFT [and RIGHT STEP one step, the right and left squads LEFT and RIGHT STEP three steps.

■ 139. BEING IN COLUMN OF THREES (OR FOURS) AT CLOSE INTERVAL BETWEEN SQUADS, MARCH (OR FORM) AT NORMAL INTERVAL.—*a.* The commands are: 1. EXTEND, 2. MARCH. At the command MARCH, the squads open to the right and left from the center by obliquing until the interval between men is one arm's length. The center squad (or squads) take up the half step until the dress has been regained.

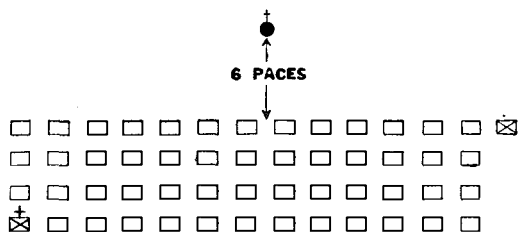

INTERVAL —ARMS LENGTH DISTANCES—40 INCHES

**1. RIFLE PLATOON IN LINE FACED TO THE FRONT.**

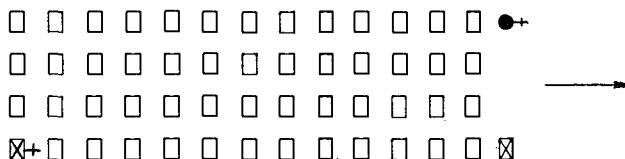

INTERVAL —ARMS LENGTH DISTANCES—40 INCHES

**2. AT THE COMMANDS: 1. RIGHT 2. FACE, THE PLATOON FACES TO THE RIGHT. PLATOON LEADER AND GUIDE CHANGE TO NEW POSITIONS.**

**AT THE COMMANDS: 1. FORWARD 2. MARCH, IT MOVES OFF.**

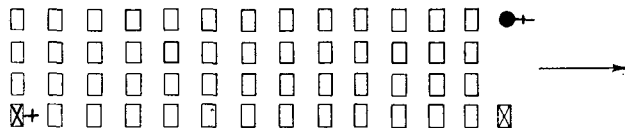

INTERVAL —4 INCHES DISTANCE 40 INCHES

**3. AT THE COMMANDS: 1. CLOSE 2. MARCH, THE SQUAD COLUMNS CLOSE TO THE CENTER.**

**LEGEND**

● PLATOON LEADER    ⊗ PLATOON GUIDE    ⊗ PLATOON SERGEANT  
 □ ALL OTHERS

FIGURE 32.—Platoon in line, marched to the right. (For detailed position of individuals, see fig. 31.)

b. If this movement is executed at the halt, the squads execute **RIGHT** or **LEFT STEP** until they have secured the proper interval by reversing the procedure outlined in paragraph 138b.

■ 140. **BEING IN COLUMN OF THREES (OR FOURS), CHANGE DIRECTION.**—The commands are: 1. **COLUMN RIGHT (LEFT)**, 2. **MARCH**. The right flank man of the leading rank (the guide and platoon leader excepted) is the pivot of this movement. At the command **MARCH**, given as the right foot strikes the ground, the right flank man of the leading rank faces to the right in marching as prescribed in paragraph 29 a and b, and takes up the half step until the other men of his rank are abreast of him, then he resumes the full step. The other men of the leading rank oblique to the right in marching without changing interval, place themselves abreast of the pivot man, and conform to his step. The ranks in rear of the leading rank execute the movement on the same ground and in the same manner as the leading rank.

■ 141. **BEING IN COLUMN OF THREES (OR FOURS), FORM LINE TO FRONT.**—The commands are: 1. **COLUMN RIGHT**, 2. **MARCH**, 3. **PLATOON**, 4. **HALT**, 5. **LEFT**, 6. **FACE**. Column right is executed as prescribed in paragraph 140. The command **HALT** is given after the change of direction is completed.

■ 142. **BEING IN ANY FORMATION IN MARCH, MARCH TOWARD FLANK.**—The commands are: 1. **BY THE RIGHT (LEFT) FLANK**, 2. **MARCH**. This movement is executed as prescribed for the squad in paragraph 124. If the platoon is in column at close (4-inch) interval, the squads in rear of the squad which becomes the leading squad take up the half-step until they each reach 40 inches distance from the squad ahead. This movement is used only for short distances.

■ 143. **STACK ARMS.**—Before stacking arms, ranks are opened. Arms are then stacked by each squad as prescribed in paragraph 127.

■ 144. **BEING IN LINE, OPEN AND CLOSE RANKS.**—a. To open ranks the commands are: 1. **OPEN RANKS**, 2. **MARCH**, 3. **READY**, 4. **FRONT**. At the command **MARCH**, the front rank takes three steps forward, halts, and executes **DRESS RIGHT**. The second rank takes two steps forward, halts, and executes **DRESS RIGHT**. The third rank takes one step forward, halts,

and executes **DRESS RIGHT**. The fourth rank, if any, executes **DRESS RIGHT**. The platoon leader places himself on the flank of the platoon toward which the dress is to be made, 1 pace from and in prolongation of the front rank and facing down the line. From this position he alines the front rank. The second and third ranks are alined in the same manner. In moving from one rank to another, the platoon leader faces to the left in marching. After verifying the alinement of the rear rank, he faces to the right in marching, moves 3 paces beyond the front rank, halts, faces to the left and commands: 1. **READY**, 2. **FRONT**.

b. To close ranks, the commands are: 1. **CLOSE RANKS**, 2. **MARCH**. At the command **MARCH**, the front rank stands fast; the second rank takes one step forward and halts; the third rank takes two steps forward and halts; and the fourth rank, if any, takes three steps forward and halts. Each man covers his file leader.

■ 145. **FORM FOR SHELTER TENTS**.—The platoon being in line the commands are: 1. **FORM FOR SHELTER TENTS TO THE LEFT (RIGHT)**, 2. **MARCH**, 3. **DRESS RIGHT (LEFT)**, 4. **DRESS**, 5. **READY**, 6. **FRONT**, 7. **COUNT OFF**.

a. At the command **FORM FOR SHELTER TENTS TO THE LEFT (RIGHT)**, the second in command moves to a position on the right of the guide who is on the right of the right man of the front rank. The messenger takes position on the left of the left man of the rear rank.

b. At the command **MARCH**, all squads except the front squad face to the left in marching and step off. Squad leaders by giving the appropriate commands: 1. **BY THE RIGHT (LEFT) FLANK**, 2. **MARCH**, and 1. **SQUAD**, 2. **HALT**, move their squads into line abreast of the squad(s) already on line.

c. At the commands 3. **DRESS RIGHT (LEFT)**, 4. **DRESS**, 5. **READY**, 6. **FRONT**, and 7. **COUNT OFF**, given by the platoon leader the entire rank executes these movements as prescribed in paragraphs 118 and 119.

d. On direction of the platoon leader, the odd numbers draw their bayonets and thrust them into the ground alongside the outside of the left heel near the instep. The bayonet indicates the position of the front tent pole. Men not equipped with bayonets mark the place with the left heel. Odd and even numbers (Nos. 1 and 2; Nos. 3 and 4; etc.) pitch tents together.

e. To assemble, the platoon is faced to the right and reformed from single file into column of threes (or fours) to the right (left) as prescribed in paragraph 146c(2). The platoon sergeant and messenger resume their normal posts.

■ 146. COLUMN OF TWOS AND SINGLE FILE AND RE-FORM.—The platoon may be marched in column of twos or single file by the procedure given below. This is not a precise movement. It is practiced in drill so that when necessary the movement may be executed smoothly and without delay. The change of column is always made from a halt.

a. (1) The platoon being in column of threes at a halt, to form column of twos the commands are: 1. COLUMN OF TWOS FROM THE RIGHT (LEFT), 2. MARCH. At the command MARCH, the right two squads march forward; the left squad forms column of twos as prescribed for the squad and then executes COLUMN HALF RIGHT and COLUMN HALF LEFT so as to follow in column the leading squads. Forty-inch distances are maintained.

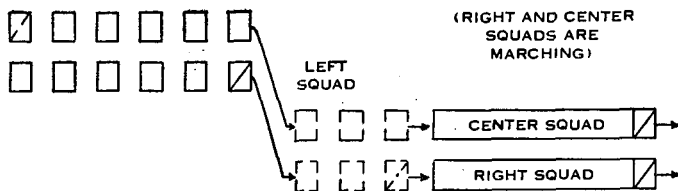

FIGURE 33.—Column of twos from column of threes.

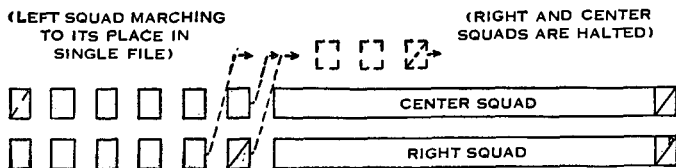

FIGURE 34.—Re-form column of three from column of two.

(2) The platoon being in column of twos at a halt, to reform in column of threes, the commands are: 1. COLUMN OF THREES TO THE LEFT (RIGHT), 2. MARCH. At the command MARCH, the leading two squads stand fast. The rear squad forms single file from the right as prescribed in paragraph 130b and moves to its normal place beside the leading squads by executing COLUMN HALF LEFT then COLUMN HALF RIGHT.



It is halted when its leading file is on line with the leading rank of the platoon.

b. (1) The platoon being in column of fours at a halt, to form column of twos, the commands are: 1. COLUMN OF TWOS FROM THE RIGHT (LEFT), 2. MARCH. At the command MARCH, the right two squads march forward; the left two squads initially stand fast, then follow the leading two squads by executing COLUMN HALF RIGHT and COLUMN HALF LEFT. Forty-inch distances are maintained.

(2) The platoon being in column of twos at a halt, to reform in column of fours, the commands are: 1. COLUMN OF FOURS TO THE LEFT (RIGHT), 2. MARCH. At the command MARCH, the leading two squads stand fast. The two rear squads move to their normal places by executing COLUMN HALF LEFT then COLUMN HALF RIGHT, and are halted when the leading files are on line with the leading rank of the platoon.

c. (1) The platoon being in column of threes (or fours) at a halt, to form single file, the commands are: 1. COLUMN OF FILES FROM THE RIGHT (LEFT), 2. MARCH. At the command MARCH, the right squad of the platoon moves forward. The other squads stand fast initially and then successively follow the leading squad by executing COLUMN HALF RIGHT and COLUMN HALF LEFT. Distances of 40 inches are maintained.

(2) The platoon being in single file at a halt, to re-form in column of threes (or fours), the commands are: 1. COLUMN OF THREES (OR FOURS) TO THE LEFT (RIGHT), 2. MARCH. At the command MARCH, the leading squad stands fast. The other squads move to their normal places by executing COLUMN HALF LEFT, then at the proper time COLUMN HALF RIGHT, and are halted when the leading file is on line with the leading rank of the platoon.

d. Whenever commands are given involving movements of squads in which one squad stands fast, takes up the march, continues the march, or changes formation, the squad leader gives the appropriate commands.

### SECTION III

#### COMPANY

■ 147. GENERAL.—a. The company consists of a company headquarters and two or more platoons.

b. For close order drill and ceremonies, company headquarters personnel present are attached to platoons to equalize the strength thereof. A usual disposition for this purpose is shown in figure 37. Members of the company headquarters are formed for marches or special purposes as shown in figure 36 or as directed by the company commander or higher authority.

c. The first sergeant takes post as follows for drills and ceremonies:

(1) *With company in line.*—At normal distance in rear of the squad leader of the rear squad of the left center (or center) platoon.

(2) *With company in column of platoons (rifle platoons [being in columns of fours and the weapons platoon in column [of threes).*—At normal distance in rear of the left squad of the rear platoon for drills and ceremonies. For march formations, his position is as shown in figure 36.

(3) *With company in mass formation.*—At normal distance in rear of the second in command of the left (or left center) platoon.

d. The first sergeant takes post in march formation at normal distance behind the company commander.

e. The guidon bearer takes post as follows for drills and ceremonies:

(1) *With company in line or in mass formation.*—One pace to the rear and 3 paces to the left of the company commander.

(2) *With company in column of threes or fours.*—As shown in figure 36.

f. For marches in the field, the guidon is disposed with the company headquarters baggage or as otherwise directed. If carried by the guidon bearer he takes the position shown in figure 36.

■ 148. RULES FOR COMPANY DRILL.—a. The platoon, rather than the company, is the basic close order drill unit. Only such formations are prescribed for the company as are necessary for marches, drills, and ceremonies.

b. Platoon leaders repeat such preparatory commands as are to be executed immediately by their platoons, such as FORWARD, and the men execute the movement if it applies to their platoons at the command of execution, such as

**MARCH** and **HALT**, given by the company commander. In movements executed in **ROUTE STEP** and **AT EASE**, the platoon leaders repeat the command of execution if necessary. Platoon leaders do not repeat the company commander's commands in having the company fall out, stack arms, take arms, or in executing the manual of arms, nor those commands which are not essential to the execution of a movement by their platoons. In giving commands or cautions, platoon leaders may prefix the numbers of the platoons, as: **FIRST PLATOON, HALT**; or **SECOND PLATOON, FORWARD**.

c. Whenever commands are given involving movements of the company in which one platoon stands fast or continues the march, its platoon leader commands: **STAND FAST**, or cautions, **CONTINUE THE MARCH**, as the case may be.

d. The company does not march forward when in line except for minor changes in position.

■ 149. **FORM COMPANY**.—a. The first sergeant takes post 9 paces in front of the point where the center of the company is to be, faces that point and commands: **FALL IN**. At the command **FALL IN**, the company forms in three (or four) ranks with normal interval between men (unless close interval is directed) and 3-pace intervals between platoons as indicated in figure 35.

b. Each platoon sergeant takes post 3 paces in front of the point where the center of his platoon will be. The platoons form in their proper places under supervision of the platoon sergeants.

c. The platoon sergeants then command: **REPORT**. Remaining in position (at **ORDER ARMS** if armed with the rifle), the squad leaders, in succession from front to rear in each platoon, salute and report, "All present," or "Private \_\_\_\_\_ absent." Platoon sergeants then command: 1. **INSPECTION**, 2. **ARMS**, 3. **LOCK PIECES** (if armed with the M1 rifles), [4. **ORDER**, 5. **ARMS**, and face about. Men armed with the [automatic rifle and the pistol excute inspection arms at the [command: 1. **INSPECTION**, 2. **ARMS**. At the command **REPORT** given by the first sergeant, the platoon sergeants successively, beginning with the right platoon, salute and report, "All present or accounted for" or "\_\_\_\_\_ men absent."

d. All platoons having reported, the first sergeant commands: **POSTS**. The platoon sergeants face about and move

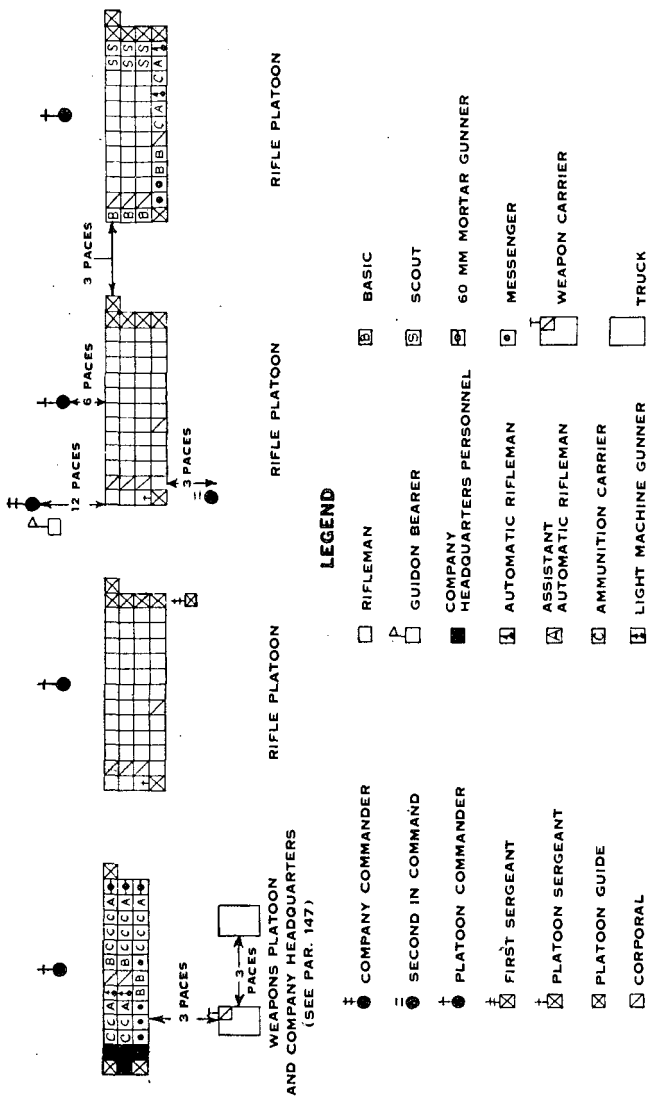

FIGURE 35.—Rifle company in line.

by the most direct routes to the positions shown in figure 35. The first sergeant then faces the company commander, salutes, and reports, "Sir, all present or accounted for" or

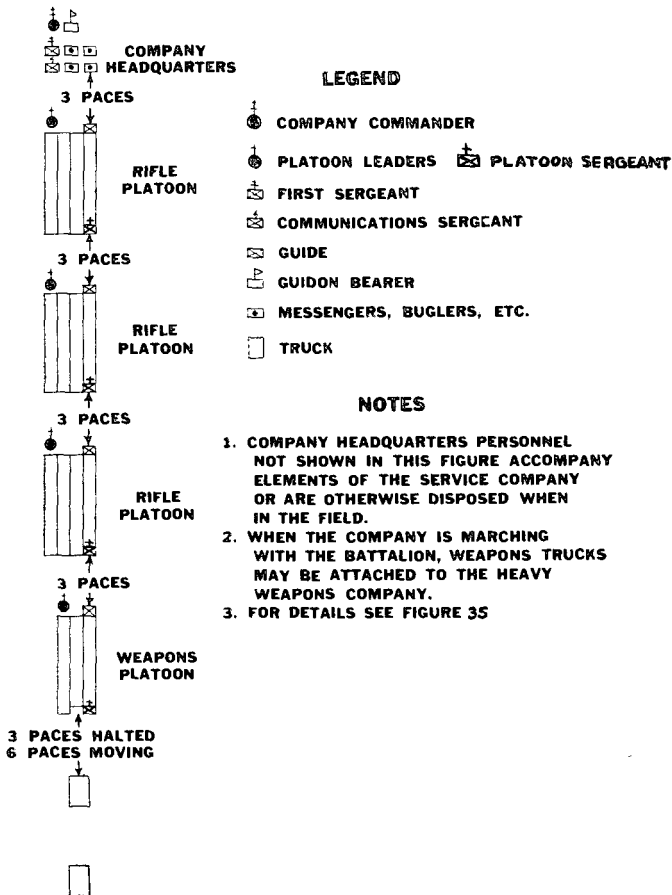

FIGURE 36.—Rifle company in march formation.

"Sir, ——— men absent," and without command faces about and moves by the most direct route to the position shown in figure 35.

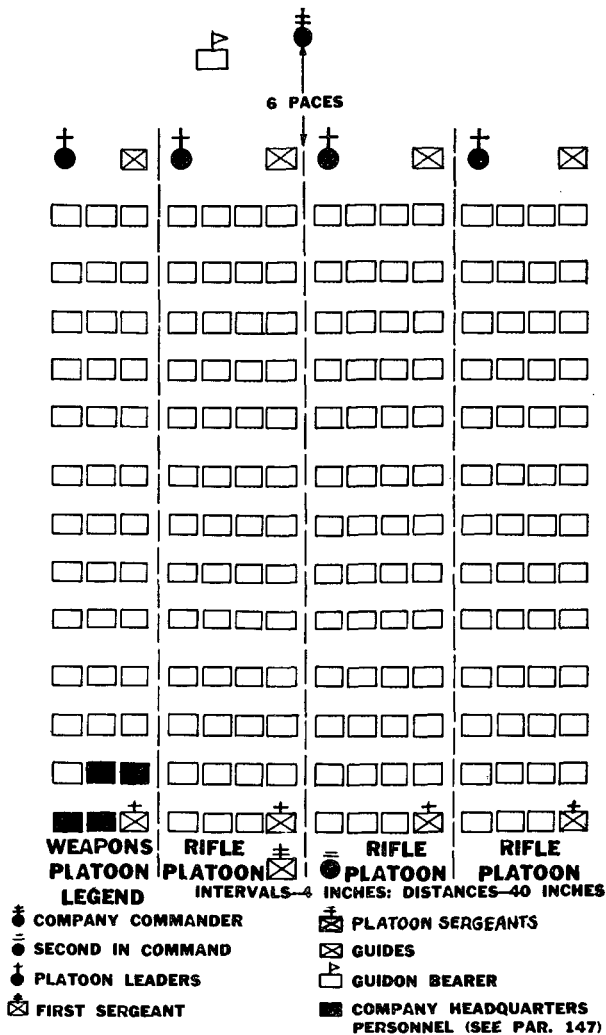

FIGURE 37.—Rifle company in mass formation (interval between men 4 inches; distance between men 40 inches).

e. If the platoons cannot be formed in regularly organized squads, the platoon sergeants command: 1. INSPECTION, 2. ARMS, 3. LOCK PIECES (if armed with M1 rifles), 4. RIGHT SHOULDER, 5. ARMS, and call the rolls. Each man as his name is called answers "Here," and comes to ORDER ARMS. The platoon sergeants then divide the platoons into squads and report as described above.

f. The company commander places himself 12 paces in front of the center of and facing the company in time to receive the report of the first sergeant. The second in command and officers commanding platoons take their posts immediately after the first sergeant has reported and draw saber with the company commander.

g. In forming the company, all who are required to salute and make a report maintain the position of salute until it is returned.

■ 150. BEING IN LINE, MARCH TO RIGHT.—*a.* The company is faced to the right and marched as prescribed for the platoon in paragraph 136c. The company commander, first sergeant, and guidon take positions as shown in figure 36. The second in command of the company will normally take post in rear of the second in command of the rear platoon at 40 inches distance. For drills and ceremonies, the first sergeant takes position as prescribed in paragraph 147c(2).

*b.* The company marches to the left from line only for minor changes of position.

■ 151. FORM WITH CLOSE INTERVAL BETWEEN MEN.—The commands are: 1. AT CLOSE INTERVAL, 2. FALL IN. At the command FALL IN, the company forms as prescribed in paragraph 149 with each platoon forming as prescribed in paragraph 134b. This formation is used only for roll calls or where space is limited.

■ 152. DISMISS COMPANY.—*a.* The company being in line at a halt, the company commander directs the first sergeant, "Dismiss the company." The officers fall out; the first sergeant moves to a point 9 paces in front of the center of the company, salutes the company commander, faces toward the company, and commands: 1. INSPECTION, 2. ARMS, 3. PORT, 4. ARMS, 5. DISMISSED, or, for troops armed with the U. S. rifle, caliber .30, M1, 1. INSPECTION, 2. ARMS, 3. UNLOCK PIECES, 4. DISMISSED.

b. Dismissal may also take place by the command: **DISMISS YOUR PLATOONS**. The platoons being in line at a halt are then dismissed on direction of the individual platoon leaders to the platoon sergeants. Each platoon sergeant takes post 3 paces in front of the center of his platoon and commands: 1. **INSPECTION**, 2. **ARMS**, 3. **PORT**, 4. **ARMS**, 5. **DISMISSED**, or for troops armed with the U. S. rifle, caliber .30, M1, 1. **INSPECTION**, 2. **ARMS**, 3. **UNLOCK PIECES**, 4. **DISMISSED**.

■ 153. **ALINE COMPANY**.—The company being in line at a halt, to align the company the command is: **DRESS RIGHT (CENTER or LEFT)**. At the command **DRESS RIGHT**, the platoon leader of the base platoon dresses his platoon immediately. When **DRESS CENTER** is given, the leader of the center platoon dresses his platoon to the right. Each platoon leader dresses his platoon toward the center (right or left) of the company as soon as the base platoon or the platoon next toward the base platoon has completed its dress. When in mass formation the commands are given by the company commander, and the alinement of each rank is verified expeditiously by the platoon leader of the base platoon.

■ 154. **PREVIOUS INSTRUCTION APPLICABLE**.—The company marches, executes changes of direction, closes and extends intervals between squads in column of threes or fours, opens and closes ranks, stacks and takes arms as in platoon drill.

■ 155. **BEING IN COLUMN OF THREES OR FOURS AT CLOSE INTERVAL, FORM COMPANY MASS**.—*a*. The company being at a halt, the commands are: 1. **COMPANY MASS LEFT (RIGHT)**, 2. **MARCH**. At the command **MARCH**, the leading platoon stands fast. The rear platoons move to position alongside the leading platoon(s) at 4-inch intervals by executing **COLUMN HALF LEFT** then **COLUMN HALF RIGHT**. Each platoon is halted when its leading rank is on line with the leading rank of the platoon(s) already on line. This forms the company in mass, with 4-inch intervals between all men in ranks.

*b*. The company being in march, the commands are the same as given in *a* above. The movement is executed as described in *a* above, except that immediately after the command **MARCH**, the leading platoon is halted by the commands: 1. **PLATOON**, 2. **HALT**, given by its own leader.



156. BEING IN COLUMN OF THREES OR FOURS, FORM EXTENDED MASS FORMATION.—The commands are: 1. COMPANY MASS —→

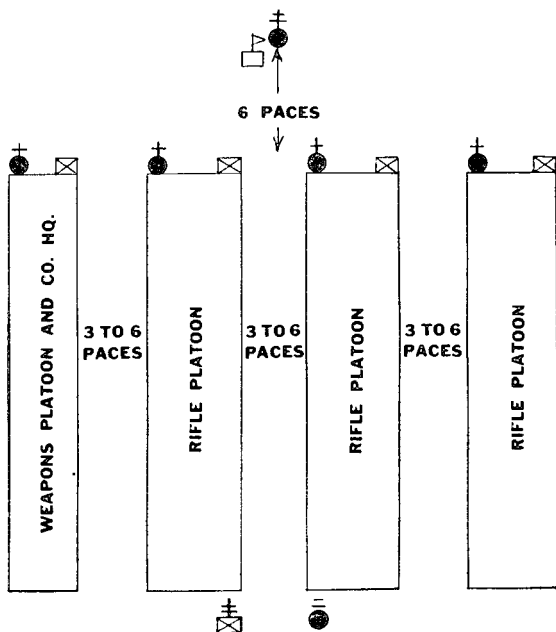

### LEGEND

⊕	COMPANY COMMANDER	⊕	FIRST SERGEANT
⊖	SECOND IN COMMAND	⊗	GUIDES
⊕	PLATOON LEADERS	⊐	GUIDON BEARER

FIGURE 38.—Rifle company in extended mass formation.

PACES LEFT (RIGHT), 2. MARCH. At the command MARCH, the movement is executed as described in paragraph 155:

## ERRATA SHEET

---

### BASIC FIELD MANUAL INFANTRY DRILL REGULATIONS

Paragraphs 157 and 184 are changed as follows:

■ 157. BEING IN MASS FORMATION, CHANGE DIRECTION.—*a.* The [comands are: 1. RIGHT (LEFT) TURN, 2. MARCH, 3. FORWARD, [4. MARCH. The right flank man of the line of guides and platoon leaders is the pivot of this movement. At the com-[mand 2. MARCH, he faces to the right in marching and [takes up the half step. Other first rank men execute a [RIGHT OBLIQUE, advance until opposite their place in line, execute a second RIGHT OBLIQUE, and upon arriving abreast of the pivot man take up the half step. Each succeeding rank executes the movement on the same ground and in the same manner as the first rank. All take the full step [at the command 4. MARCH, which is given after the entire company has changed direction.

*b.* In turning to the left on a moving pivot, each rank dresses [to the left until the command 4. MARCH, and after that the dress is to the right unless otherwise announced.

*c.* The company commander faces to the rear and marches backward until the change in direction has been completed.

[A. G. 062.11 (9-26-41).]

■ 184. BEING IN MASS FORMATION, CHANGE DIRECTION.—The [commands are: 1. RIGHT (LEFT) TURN, 2. MARCH, 3. FORWARD, [4. MARCH. The movement is executed as prescribed for foot troops in paragraph 157. The vehicles on the inside of the turn preserve the prescribed 6-pace distance. The vehicles on the outside of the turn increase their speed to keep abreast.

[A. G. 062.11 (9-26-41).]

except that the rear platoons move to position alongside the leading platoon(s) at the intervals ordered by executing **COLUMN LEFT** and **COLUMN RIGHT**. Each platoon is halted when its leading rank is on line with the leading rank of the platoon(s) already on line. This formation is used for drills and ceremonies if it is desired to increase the size of the mass in order to present a more impressive appearance. The company in this formation drills in the same manner as for mass formation, maintaining the interval between platoons. The extended mass formation is also utilized in forming the company for inspection as prescribed in paragraph 241.

■ 157. **BEING IN MASS FORMATION, CHANGE DIRECTION.**—*a.* The [commands are: 1. **RIGHT (LEFT) TURN**, 2. **MARCH**. The right flank man of the line of guides and platoon leaders is the pivot of this movement. At the command **MARCH**, he faces to the right in marching and takes up the half step. Other first rank man executes a **RIGHT OBLIQUE**, advances until opposite his place in line, executes a **second RIGHT OBLIQUE** and, upon arriving abreast of the pivot man, takes up the half step. Each succeeding rank executes the movement on the same ground and in the same manner as the first rank. All take the full step at the command **MARCH**, which is given after the entire company has changed direction.

*b.* In turning to the left on a moving pivot, each rank dresses to the left until the command **MARCH** and after that the dress is to the right unless otherwise announced.

*c.* The company commander faces to the rear and marches backward until the change in direction has been completed.

■ 158. **BEING IN COMPANY MASS, FORM COLUMN OF THREES (OR FOURS).**—Being at a halt, the commands are: 1. **COLUMN OF THREES (OR FOURS)**, 2. **RIGHT PLATOON, FORWARD**, 3. **MARCH**. At the command **MARCH** the right platoon marches forward. The other platoons follow in column in their normal formation successively by executing **COLUMN HALF RIGHT** and **COLUMN HALF LEFT** upon the commands of their respective leaders.

## CHAPTER 5

### DRILL FOR UNITS WITH ANIMAL-DRAWN CARTS OR PACK ANIMALS

■ 159. **GENERAL.**—Units equipped with animal-drawn carts or pack animals follow the same drill as is prescribed in

chapter 6 for units with motor carriers with the modifications indicated in the succeeding paragraphs.

■ 160. SQUAD AND ITS TRANSPORTATION.—*a.* The squad consists of a squad leader, a crew to handle the weapons or equipment, mule leaders, and one or more carts or pack animals depending upon the equipment. Some weapons may be provided with a wheeled mount which is attached to and trailed by one of the carts.

*b.* Each member of the gun squad except the squad leader is given a number as prescribed in the special gun drill for the weapon. The squad leader is not numbered. Mule leaders take the last numbers in the squad. Assistant mule leaders take the next lower numbers.

*c.* If the squad has two carts (a gun cart and an ammunition cart) or pack mules instead of carts, they are formed one behind the other with 2 paces distance and remain in this formation at all times.

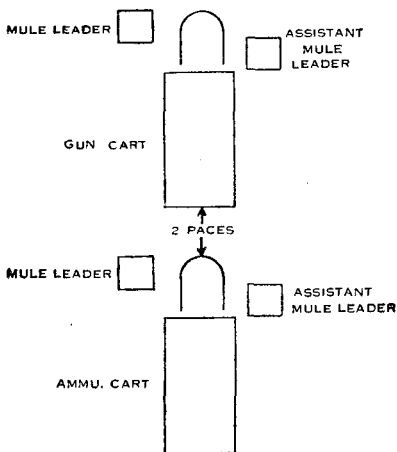

FIGURE 39.—Squad with two carts.

The two carts taken together maneuver in the manner prescribed for a single truck in the drill for units with motor carriers. Carts or pack animals form and march with 2 paces distance and not with the distances prescribed for motor vehicles.

■ 161. **HANDLING MULE.**—*a. Leading.*—The mule when hitched is led by means of the reins or halter tie rope. The mule leader takes position on the left side of the mule, holding the reins near the bit with his right hand, and holding the loose ends of the reins in his left hand. The assistant mule leader takes position 1 pace to the right of the hip of the mule. At drill and ceremonies the mule is led with the reins. On the march, the halter tie rope may be used. The mule is led with a loose rein and urged on from the rear, if necessary, by the assistant mule leader. The mule leader should not face or threaten the mule when leading him.

*b. Gathering.*—The mule leader raises his right hand until it touches the mule's lower jaw and at the same time exerts a slight pressure with the reins in the direction in which the movement is to be made. The object of gathering the mule is to attract his attention and prepare him for the movement. At all preparatory commands involving a movement of the cart, the mule is gathered in time to cause the movement to begin at the command of execution.

*c. Changing direction.*—The mule is led outward and away from the pivot in all changes of direction with carts in order to increase the radius of turning. The mule, while actually led in a turn to the right, may be better controlled if the mule leader places his right shoulder against the mule and guides him in the turn.

## CHAPTER 6

### DRILL FOR UNITS WITH MOTOR CARRIERS

	Paragraphs
SECTION I. General .....	162-164
II. Squad and section .....	165-169
III. Platoon .....	170-177
IV. Company .....	178-186

#### SECTION I

#### GENERAL.

■ 162. **PURPOSE.**—*a.* This chapter provides drill for units having motor carriers to transport weapons, ammunition, or other combat equipment. In this type of unit all personnel, except the drivers and certain commanders and their assist-

ants, march on foot. Units to which this drill may apply are—

(1) Machine gun, mortar, and antitank units.

(2) Headquarters and other units which have motor carriers to transport their combat equipment.

b. The sole purpose of the drill is the orderly formation and movement of such units. It is practiced for smoothness of execution. All personnel must be proficient in drill for foot troops.

■ 163. TRANSPORTATION.—a. When fully equipped, there should be one or more motor carriers per weapon squad. In peace strength units, there may be available only one truck or carrier per section (one motor carrier for each two squads). Each unit should make the adaptations to fit its requirements.

b. One or more passenger cars may be included in the company's transportation. Normally the company commander, first sergeant, and one or more messengers ride in one car at the head of the company. The second in command, transport sergeant, mechanic, and a messenger ride in another car at the rear of the company. Platoon commanders march on foot with their platoons at carrier drill.

c. The fire-control equipment of the platoon is carried in the platoon commander's car or on one of the squad carriers. The fire-control equipment of the company is carried in the company commander's car or in one of the squad carriers.

d. For the movement of the entire company by motor, additional trucks are provided by higher headquarters.

■ 164. RULES FOR MEN ARMED WITH RIFLE.—Men armed with the rifle execute INSPECTION ARMS, ORDER ARMS, SLING ARMS, and UNSLING ARMS but no other movements of the manual when in formations with their units. They will be instructed, however, in the entire manual of arms. At all formations for drill and ceremonies, such men fall in at ORDER ARMS and after executing INSPECTION ARMS (and LOCK PIECES if armed with the M1 rifle) upon command will execute SLING ARMS as prescribed in paragraph 39a. Rifles remain at the position of SLING ARMS until they are unslung as prescribed in paragraph 39b. Men in ranks may remove their rifles from their shoulders when at rest or at ease.

## SECTION II

## SQUAD AND SECTION

■ 165. ORGANIZATION OF SQUAD.—*a.* The weapons squad (machine gun, mortar, antitank) consists of a squad leader and men to operate the weapon and to serve it with ammunition.

*b.* When equipped with a motor carrier (truck or other vehicle) the weapon, its accessories, and ammunition are transported by the carrier. The members of the squad, except the carrier operator, march on foot. Antitank guns designed for towing are trailed.

*c.* The gun squad secures and carries equipment and forms as prescribed in the gun drill for the weapon. Whenever the squad is at a halt, the men ground the equipment they are carrying. Before starting any movement, the squad leader directs, "Carry equipment."

■ 166. FORMATION AT TRUCK.—Being in any formation without equipment, or with the squad carrying its equipment, to form at the truck the commands are: 1. AT YOUR TRUCK(S), 2. FALL IN. At the command FALL IN, the squad moves to its truck and forms as shown in figure 40. If one truck serves two squads, the squads form abreast.

■ 167. LOAD TRUCK(S).—Being in formation at the truck(s), the command is: LOAD TRUCK(S). At this command the gun and equipment are loaded into the truck under the direction of the squad leader. If one truck serves two squads, the section leader directs the loading. When the loading is completed, the squad re-forms without command as shown in figure 40.

■ 168. UNLOAD TRUCKS.—Being in formation at the truck(s), the command is: UNLOAD TRUCK(S). At this command, equipment is removed from the truck under the direction of the squad (or section) leader and the squad (or squads) re-forms without command as shown in figure 40.

■ 169. SECTION OPERATING ALONE.—When the section operates alone, it drills as prescribed for the platoon.

## SECTION III

## PLATOON

■ 170. ORGANIZATION.—*a.* The gun platoon consists of a headquarters and two or more squads or sections.

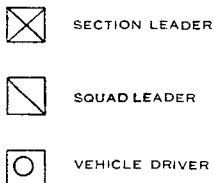
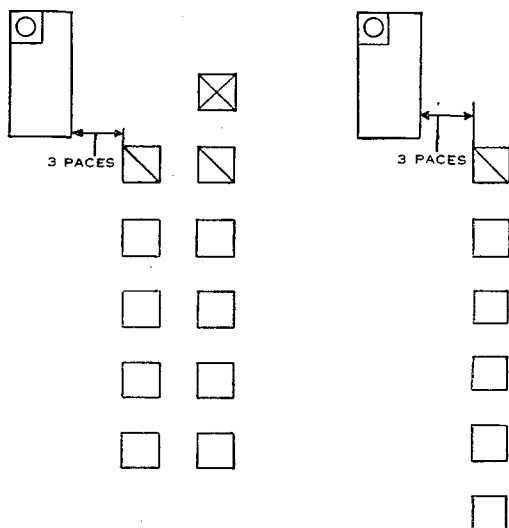

FIGURE 40.—Formation at truck.

b. The motor carriers of the platoon are grouped under the command of a designated noncommissioned officer who rides in the right carrier when in line and in the leading carrier when in column. He controls the motor carriers by command or by arm signals (ch. 11).

■ 171. FORMATION WITH MOTOR TRANSPORTATION.—a. The platoon is formed as shown in figure 41. Additional noncommissioned officers or privates authorized by Tables of Organization are placed on the left when the platoon is in line, and in rear when it is in column.



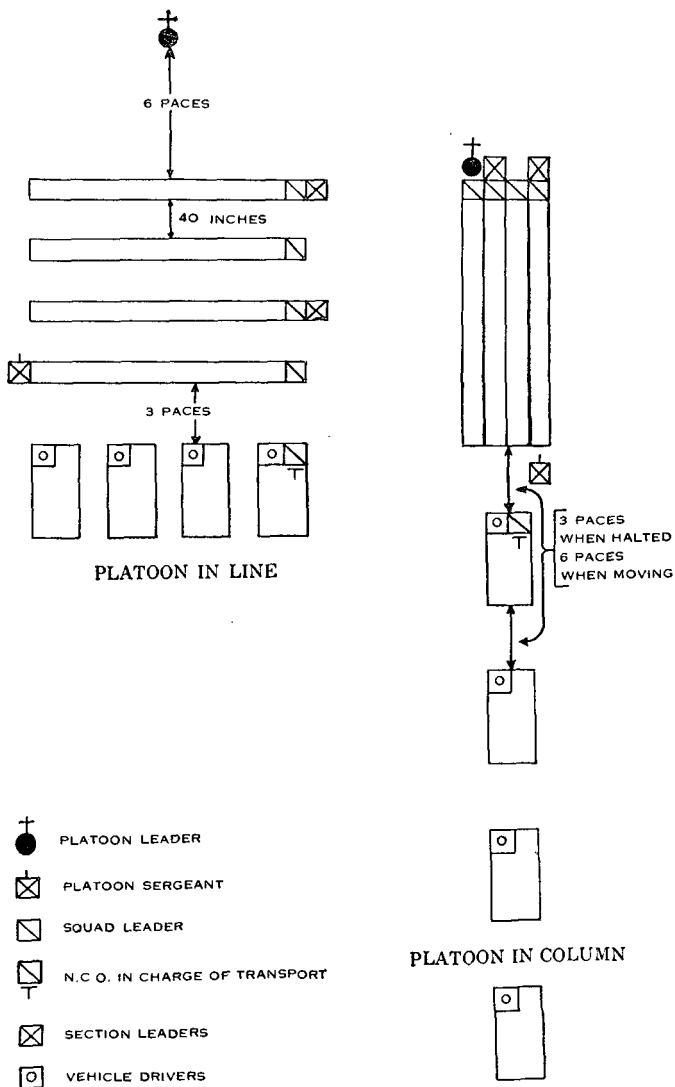

FIGURE 41.—Formations of the platoon.

b. In forming the platoon in either line or column, the loaded carriers may move to the selected position and the foot elements then form in front of them, or the foot elements after loading the carriers may form first and the carriers then take their proper positions.

c. The distance between carriers in column is 3 paces when halted and 6 paces when moving. When carriers are operating independently, other prescribed or suitable road distances and speeds are used. The interval between vehicles in line depends on the frontage of the unit behind which they form. It should not be less than 3 paces.

d. When moving the platoon with transportation, the platoon leader gives arm signals in addition to oral commands in order to be understood while the motors are running.

e. The engines of vehicles are started at the command or signal **START ENGINES** which is given prior to the command for any movement. Engines are kept running until the command or signal **STOP ENGINES** is given. At drill the engines are kept running at the halts unless the halt is to be of some duration or when it is necessary to give oral instructions.

■ 172. **BEING IN COLUMN AT A HALT, MARCH FORWARD.**—The commands are: 1. **START ENGINES**, 2. **FORWARD**, 3. **MARCH**. At the command **MARCH**, the foot element of the platoon moves forward as prescribed for foot troops in paragraph 22. The leading vehicle follows at 6 paces. Other vehicles follow with 6 paces distance between trucks. If the engines are already running the command to start engines is omitted.

■ 173. **HALT.**—The commands are: 1. **PLATOON**, 2. **HALT**. At the command **HALT**, the foot elements halt as prescribed

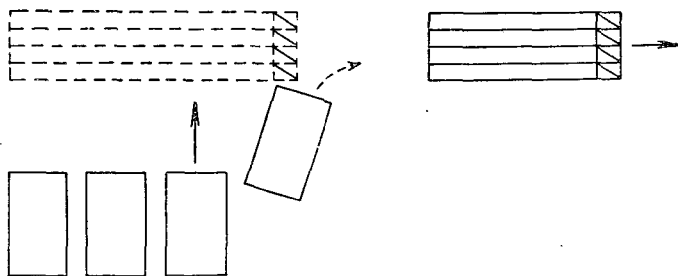

FIGURE 42.—The platoon being in line, form column to the right.

for foot troops in paragraph 24*a*, vehicles close to 3 paces distance and stop. To place the vehicles in any desired position, the platoon leader gives the necessary instruction to the noncommissioned officer in charge of the transportation.

■ 174. MOVEMENTS WITH MOTOR TRANSPORTATION.—*a*. The platoon with motor transportation marches in column formation only.

*b*. The platoon in line may move a short distance to the front or rear for the purpose of alinement with other units or getting in proper formation. The trucks move under the direction of the noncommissioned officer in charge of transportation.

■ 175. BEING IN LINE, FORM COLUMN.—The commands are: 1. RIGHT, 2. FACE, 3. FORWARD, 4. MARCH. The foot element executes RIGHT FACE and FORWARD MARCH as for foot troops. The vehicle on the right moves forward and follows the platoon at 6 paces distance. The other vehicles move forward and turn to the right, each following the preceding truck at 6 paces distance. The foot troops march at close interval or at normal interval as described in paragraphs 138 and 139.

■ 176. BEING IN COLUMN, CHANGE DIRECTION.—The commands are: 1. COLUMN RIGHT, 2. MARCH, executed as for foot troops; the trucks follow.

■ 177. BEING IN COLUMN, FORM LINE.—The platoon leader signals HALT to the vehicles. The foot troops of the platoon are then marched to and formed in line at the desired point. At the platoon leader's signal the vehicles move to their respective places in rear of the line.

#### SECTION IV

#### COMPANY

■ 178. GENERAL.—*a*. The company consists of a company headquarters and two or more platoons. The platoon is the basic drill unit. Squads, sections, and platoons are numbered as prescribed in paragraph 10. These designations do not change. The company commander may direct the platoon leaders to form their platoons in any prescribed formation.

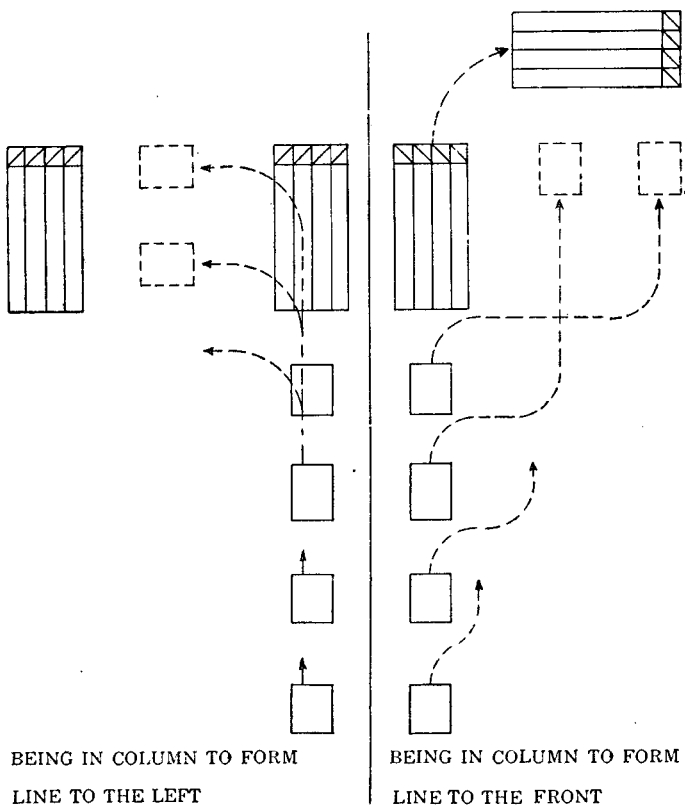

FIGURE 43.—Form line from column.

*b.* For marches in which no tactical situation is involved, the personnel of the company may be marched as a unit in front of the combined company vehicles.

*c.* For drill or ceremonies, company headquarters personnel whose positions are not otherwise prescribed are attached to platoons without interfering with the permanent squad organization.

*d.* When posted with the company commander, dismounted, in line or mass formation, the guidon is 1 pace to his rear and 3 paces to his left. When he is in formation

riding in his vehicle it is flown therefrom. In the field, it is disposed with the company headquarters' baggage or as otherwise directed.

■ 179. FORMATION WITH MOTOR TRANSPORTATION.—The procedure is similar to that prescribed for the platoon in paragraph 171. The second in command, assisted by the company and platoon transport noncommissioned officers and chauffeurs, brings up the vehicles. The foot elements are formed in line in accordance with the procedure given in paragraph 149.

■ 180. FORMATIONS.—The formations of the company with motor carriers are LINE, COLUMN, and MASS. The battalion heavy weapons company is shown in LINE, in COLUMN, and in MASS in figures 44, 45, and 46. The regimental headquarters company is shown in LINE and in MASS in figures 47 and 48.

■ 181. BEING IN LINE, FORM COLUMN.—The commands are: 1. RIGHT, 2. FACE, 3. FORWARD, 4. MARCH. This movement is executed as for the platoon. The motor carriers wait until the last platoon of the company's foot elements has passed and then follow, taking the formation shown in figure 45.

■ 182. BEING IN COLUMN, AT CLOSE INTERVAL, FORM COMPANY MASS.—*a.* The company being at a halt, the commands are: 1. COMPANY MASS 3 PACES LEFT (RIGHT), 2. MARCH. At the command MARCH, the foot elements execute the movement as prescribed for foot troops in paragraph 156. As soon as the foot elements are in place, the vehicles move forward and form in columns in rear of their respective platoons as shown in figures 46 and 48.

*b.* The company being in march, the commands are the same as given in *a* above. The movement is executed as in *a* above, except that immediately after the command or signal MARCH, the leading platoon is halted by its own leader and all vehicles stop.

■ 183. BEING IN MASS FORMATION, FORM COLUMN OF THREES (OR FOURS).—Being at a halt, the commands are: 1. COLUMN OF THREES (OR FOURS), 2. RIGHT PLATOON, FORWARD, 3. MARCH. At the command MARCH, the foot elements execute the movement as prescribed for foot troops in paragraph 158. As soon as the foot elements have completed the movement, the motor

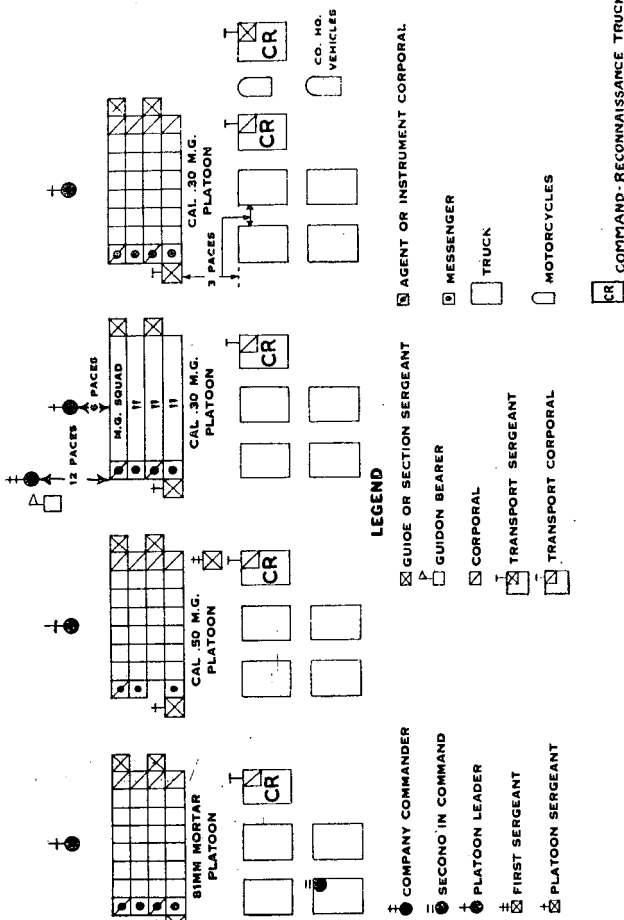

FIGURE 44.—Battalion heavy weapons company in line.

vehicles of the right platoon move forward to position as shown in figure 45, followed in column, successively, by the vehicles of the other platoons.

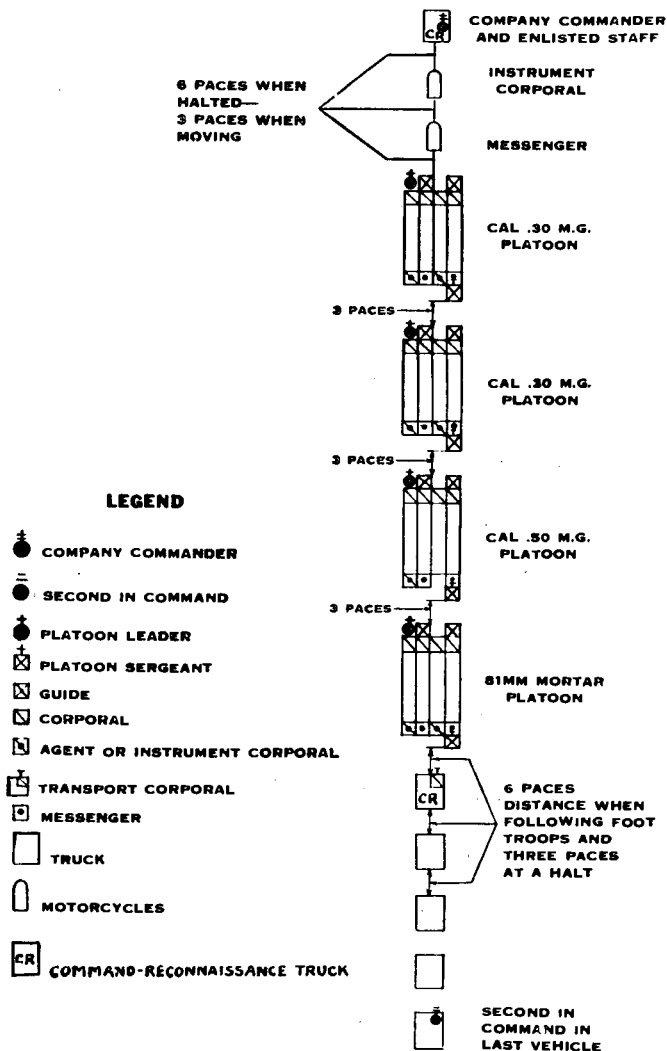

FIGURE 45.—Battalion heavy weapons company in column.

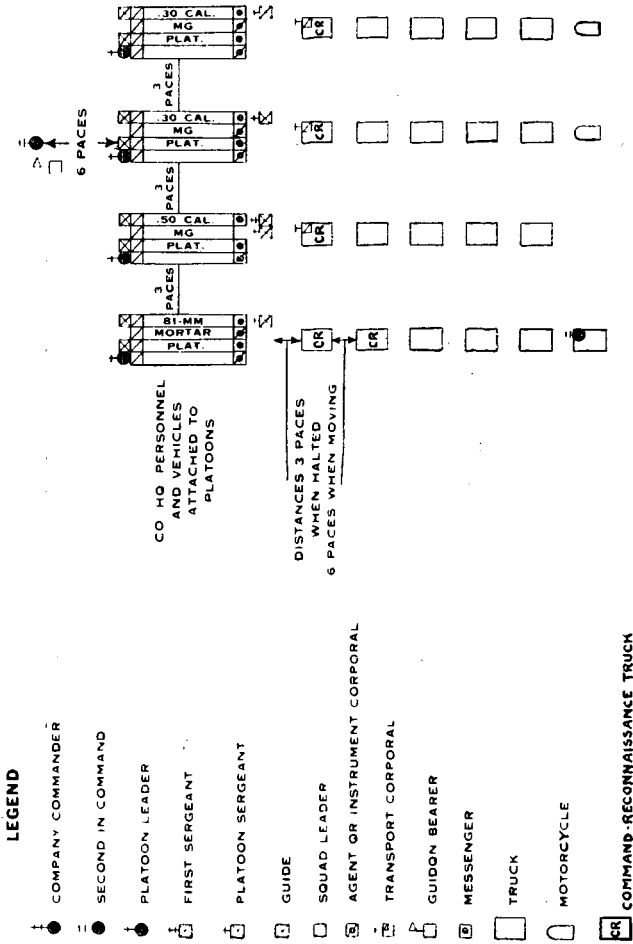

Figure 46.—Battalion heavy weapons company in mass formation.



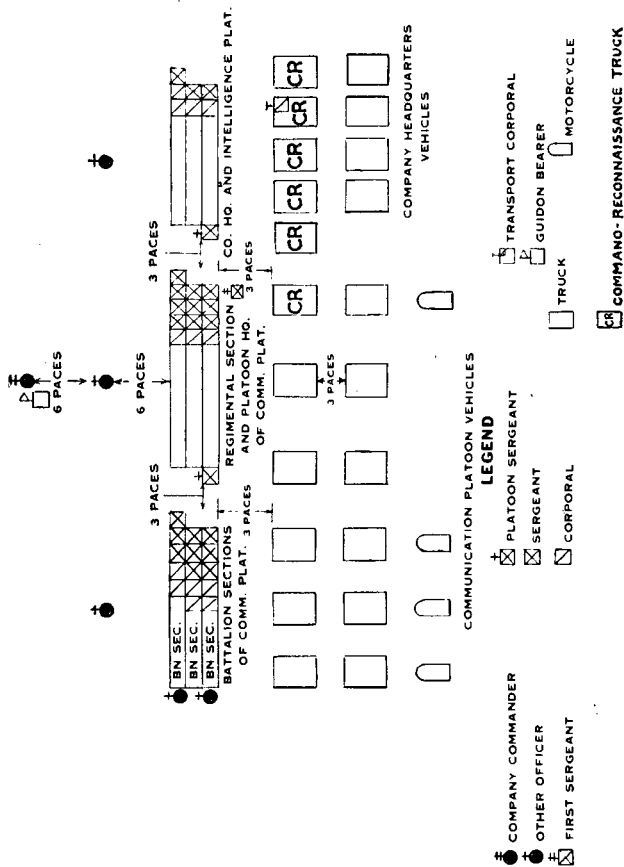

Figure 47.—Regimental headquarters company in line.



■ 184. BEING IN MASS FORMATION, CHANGE DIRECTION.—The [commands are: 1. RIGHT (LEFT) TURN, 2. MARCH. The movement is executed as prescribed for foot troops in paragraph 157. The vehicles on the inside of the turn preserve the prescribed 6-pace distance. The vehicles on the outside of the turn increase their speed to keep abreast.

■ 185. OTHER FORMATIONS OR MOVEMENTS AS REQUIRED.—The company commander explains the formation or movement to his platoon leaders and the officer (and noncommissioned officers) in charge of the trucks. Subdivisions of the company carry out such directions in the most convenient manner.

■ 186. DISMISS COMPANY.—The company is dismissed in the same manner as prescribed for foot troops in paragraph 152.

## CHAPTER 7

### DRILL FOR MOTOR AND WAGON UNITS

	Paragraphs
SECTION I. General .....	187-188
II. Single vehicle .....	189-194
III. Drill for vehicles in single column or line .....	195-200
IV. Drill for vehicles in mass formation .....	201-205
V. Company drill .....	206-210

#### SECTION I

#### GENERAL

■ 187. PURPOSE AND SCOPE.—*a.* This chapter provides drill for units in which all personnel ride in vehicles. Such units are—

- (1) Motorized machine-gun, mortar, and antitank units in which the weapons and their crews are carried in trucks.
- (2) Service companies (either motor or wagon).
- (3) Motorized headquarters units.

*b.* The sole purpose of the drill is the orderly formation and movement of such units. The movements are practiced at first in small groups with empty vehicles, later with the entire organization and with full loads. All personnel must be proficient in drill for foot troops. Personnel handling weapons are also trained in the gun drills for their weapons. All drivers will be instructed in traffic regulations and trained to drive in convoy. Officers and noncommissioned officers who command

such units will be trained in convoy operation and control (FM 25-10).

■ 188. SIGNALS.—Signals are generally given by whistle and by hand and arm movements. Because of the noise of motors, sound signals are of little value except at halts. The bugle may be used in rear areas for such signals as ATTENTION, ASSEMBLE, and FORWARD. Whistle and voice may be used at halts to attract attention. Hand and arm signals may be used both at a halt and in movement. All operating personnel, whether drivers or not, must be thoroughly trained in the use of the standard signals given in chapter 11 and impressed with the necessity for the prompt and rapid transmission of signals from one end of the column to the other. In movement, signals are given by the commander, who makes certain that the subordinate commanders receive them and promptly pass them on. Drivers use the driver's signals to warn the vehicle in rear of their movement.

## SECTION II

### SINGLE VEHICLE

■ 189. VEHICLE AND ITS LOAD.—*a.* Units armed with machine guns, mortars, or cannons carry these weapons in their unit trucks together with ammunition, accessories, and the personnel of the gun squad. Mortars and machine guns are loaded into the truck. Antitank guns, if designed for towing, are trailed.

*b.* Before entrucking, gun squads secure equipment as prescribed in the gun drill for the weapon. Headquarters personnel secure their fire-control, communication, or other equipment.

■ 190. FORM AT TRUCK.—The squad(s) being in any formation with or without weapons or equipment, the commands are: 1. AT YOUR TRUCK(S), 2. FALL IN.

*a.* At the command FALL IN, drivers, if not already there, take their seats at the controls. Other members of the squad (or occupants of the vehicle) form in single file as shown in figure 49.

*b.* As soon as they are in place, the men ground the equipment they are carrying. Men who are moving a weapon on

wheels retain their positions at the tugs and do not form a single column. Men and equipment are kept 3 paces to the right of the truck to permit trucks to move after loading or unloading is completed.

c. If the number of men in the column causes it to extend past the center of the next vehicle in rear, the leader forms it in column of twos.

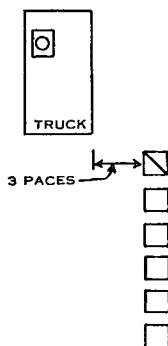

FIGURE 49.—Form at truck.

■ **191. LOAD TRUCK.**—The squad(s) being in formation at the truck the command is: **LOAD TRUCK(S)**. The weapon and other equipment are loaded into the truck under the direction of the senior noncommissioned officer. Weapons capable of antiaircraft fire if practicable are set up on their mounts in firing position in the truck. Ammunition and equipment are stowed under the seats. If the weapon is of the trailer type it is attached to the rear of the truck for towing. The men mount the truck and take seats at attention. The senior noncommissioned officer or private present in the truck signals, "Ready to start."

■ **192. UNLOAD TRUCK.**—The squad(s) being in the truck, the command is: **UNLOAD TRUCK(S)**. At this command, the men dismount in an orderly manner as prescribed by the unit commander and based on the gun drill of the weapon concerned. All take their proper loads and form at the truck as shown in figure 49. A towed cannon is disconnected and moved clear of the truck. The men who move it remain at their position at the tugs.

■ 193. **DISMOUNT, LEAVING EQUIPMENT IN TRUCK.**—The squad(s) being in the truck, the command or signal is: **DISMOUNT**. Men (except the driver) get out of the truck and take position in column at the right of the truck as shown in figure 49, leaving the equipment in the truck. If followed by the command **FALL OUT**, men leave ranks and the driver dismounts. They remain in the vicinity of the truck.

■ 194. **ENTRUCK.**—The command or signal is: **MOUNT**. The driver takes his place and the men get into the truck. The senior officer, noncommissioned officer, or private in the vehicle checks the men and when all are present signals, "Ready to start" to his next senior commander.

### SECTION III

#### DRILL FOR VEHICLES IN SINGLE COLUMN OR LINE

■ 195. **GENERAL RULES.**—*a.* The number and type of vehicles in a section or platoon are governed by Tables of Organization. A section of weapons usually consists of two guns with a truck for each gun and its crew. A battalion section of the service company transportation platoon may have seven or more vehicles. Since the vehicles of a section or platoon normally form in line or in column, the number of vehicles is immaterial to the drill.

*b.* Complicated maneuvers are not executed with vehicles. Movements are generally limited to getting the vehicles into a column formation where they can follow a leader.

*c.* Signals are given as a warning. On the command or signal to move, the leading (or right) vehicle moves out. The other vehicles follow successively in column, each starting in time to follow at a distance prescribed to suit the occasion.

*d.* All conform to the speed of the commander's vehicle. For drill and ceremonies with foot troops, vehicles conform to the foot-rate of march (about 3 miles per hour). Movements should be practiced at this speed. Some practice should be given at 10 miles per hour for use when it is not necessary to conform to foot-troop speed.

■ 196. **FORMATIONS.**—The formations for a group such as a section or platoon are line and column.

*a.* In line, the front edges of the vehicles are alined.

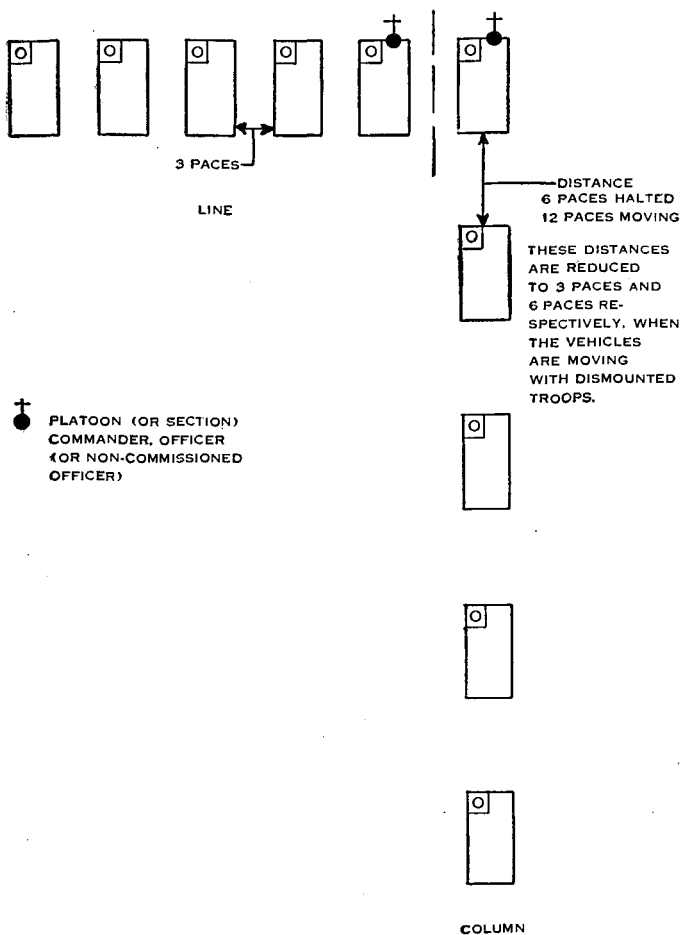

FIGURE 50.—Formation of a group in line or column.

- b. The commander of the unit rides in the right vehicle when in line and the leading vehicle when in column.
- e. The second in command (and a mechanic, if the section or platoon has one) rides in the left vehicle when in line and the rearmost vehicle when in column.

d. Vehicles are arranged in any convenient manner. When necessary, the distances and intervals may be changed to meet requirements of space.

e. Engines of trucks are started at the command or signal **START ENGINES** which is given prior to the command for any movement. Engines are kept running until the command or signal **STOP ENGINES** is given. At drill, engines are kept running at halts unless the halt is to be of some duration.

■ 197. **FORM COLUMN OR LINE.**—The vehicles being in any formation, the commander places his vehicle at the desired position, signals **ASSEMBLE**, and then extends his arm hori-

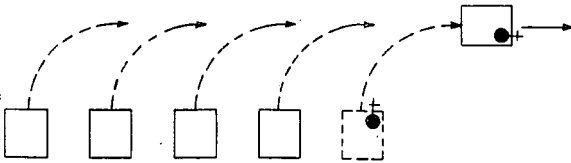

TO FORM COLUMN AND MOVE TO THE RIGHT

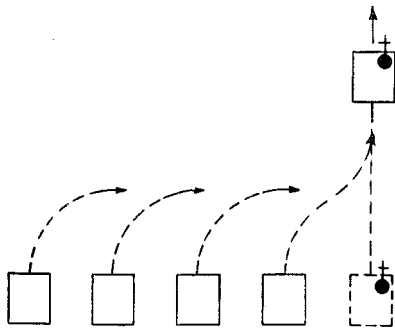

TO FORM COLUMN AND MOVE TO THE FRONT

FIGURE 51.—Being in line, form column.

zontally pointing down the line or column on which the vehicles are to form. The vehicles then move to position in column or line as indicated. The commander or an assistant may dismount and direct the formation.



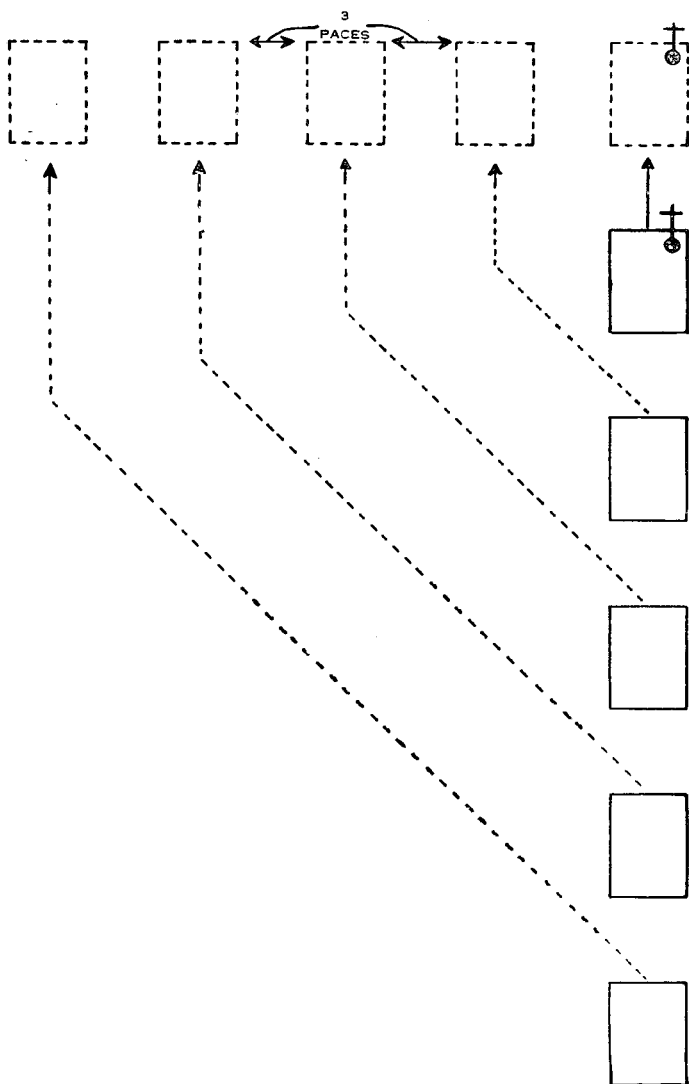

FIGURE 52.—Being in column, form line.

■ 198. BEING IN LINE, FORM COLUMN.—The commander gives the signal FORWARD OR (TO THE RIGHT), indicating the direction, gets in his car and moves in the desired direction. Other vehicles in succession from the right turn and follow at the prescribed distance.

■ 199. BEING IN COLUMN, HALT.—The warning signal STOP is given by the commander and driver in the leading vehicle. The commander has his vehicle slow down and stop. Other vehicles close to 3 paces and stop.

■ 200. BEING IN COLUMN, FORM LINE.—The commander halts the leading truck 6 or more paces in rear of the desired line, signals ASSEMBLE, and then extends his arm horizontally indicating the line on which the trucks are to form. The leading truck then moves forward 6 or more paces (so as to give the truck in rear space to maneuver). Other trucks move to the line and halt.

#### SECTION IV

#### DRILL FOR VEHICLES IN MASS FORMATION

(Two or more columns)

■ 201. GENERAL.—*a.* When a unit consists of two or more subdivisions, the trucks of each subdivision (section or platoon) are formed in parallel lines or columns.

*b.* The commander's car (or the vehicle in which he rides) takes position 6 paces in front of the center of the formation.

*c.* Each column of vehicles when practicable should be a complete unit of an organization. For drill and ceremonies if the subdivisions of an organization vary greatly in size, it is advisable to redistribute vehicles so as to have columns of approximately the same length. The formation should consist preferably of three or four columns so that it may be moved in column of threes or fours. Small units may use two columns and move in column of twos.

*d.* Each column forms, secures equipment, loads, and maneuvers as is prescribed for a unit in single line or column in section III.

*e.* Vehicles aline themselves to the right in each line.

■ 202. FORM IN COLUMN OF THREES (OR OTHER NUMBER).—The commander announces or sends word to the com-

manders of subdivisions that the unit will form with platoons (or other subdivision) abreast. He places his vehicle in the desired position and the subdivisions (sections or platoons) form successively as shown in figure 53.

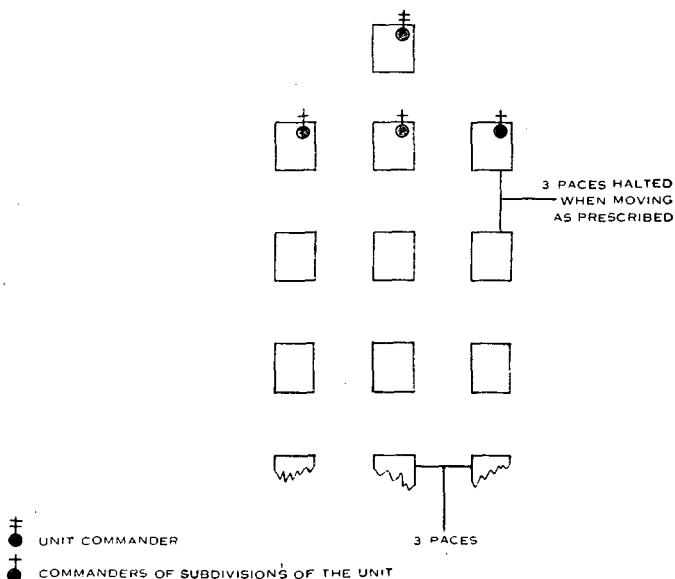

THE NUMBER OF COLUMNS ABREAST MAY BE TWO THREE OF FOUR, DEPENDING ON THE NUMBER OF SUBDIVISIONS IN THE UNIT OR THE SPACE AVAILABLE FOR ITS FORMATION

FIGURE 53.—Vehicles in mass formation.

203. BEING IN FORMATION WITH SEVERAL COLUMNS ABREAST, MOVE FORWARD.—The commander signals FORWARD and causes his vehicle to move forward. Other vehicles follow, extending their distance to 6 paces or to other distance as prescribed.

204. BEING IN FORMATION WITH SEVERAL COLUMNS ABREAST, CHANGE DIRECTION.—If at a halt the commander signals FORWARD indicating the direction of march. If moving, the change in direction is indicated by the driver's signal, TURN

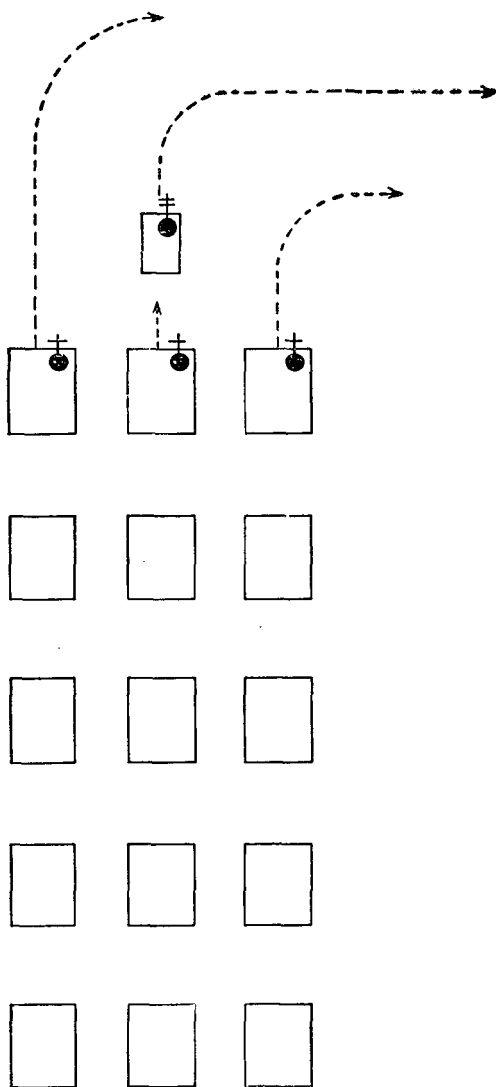

FIGURE 54.—Being in formation with several columns abreast, change direction.

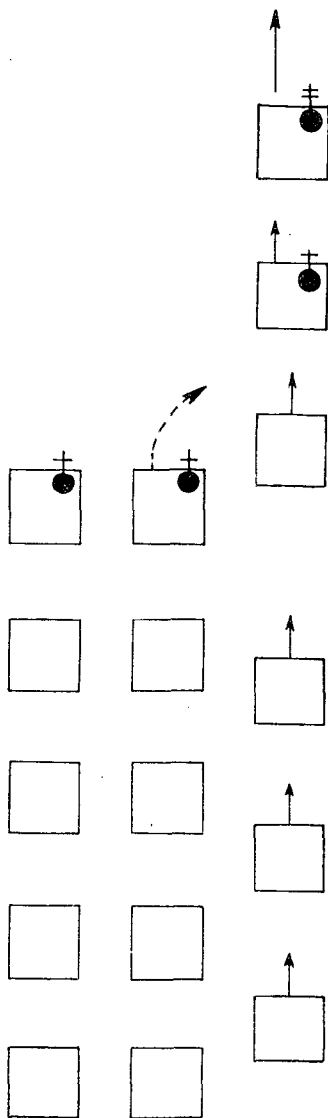
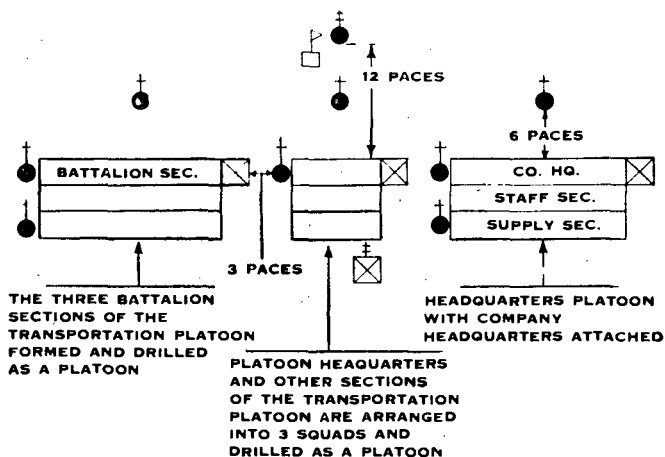

FIGURE 55.—Being in formation with several columns abreast, form a single column.

RIGHT OR TURN LEFT. The commander causes his vehicle to move in the desired direction. Other vehicles conform. The speed of the vehicles on the outside of the turn is increased.

205. BEING IN FORMATION OF SEVERAL COLUMNS ABREAST, FORM SINGLE COLUMN.—*a.* The commander signals or announces COLUMN and points to the column leader who is to lead off. He then moves his vehicle in the desired direction. The leader of the designated column causes his vehicle to follow at the prescribed distance. Other vehicles of that column follow. Other columns follow in succession.

*b.* If executed while moving, the commander increases the speed of his vehicle. Vehicles in the designated column follow the commander's vehicle at the increased speed. Other trucks continue at the original speed until their turn comes to follow, when their speed is increased to conform to the speed of the vehicles ahead. When the movement has been completed the original speed is resumed.



① Foot elements in line.

FIGURE 56.—Service company.

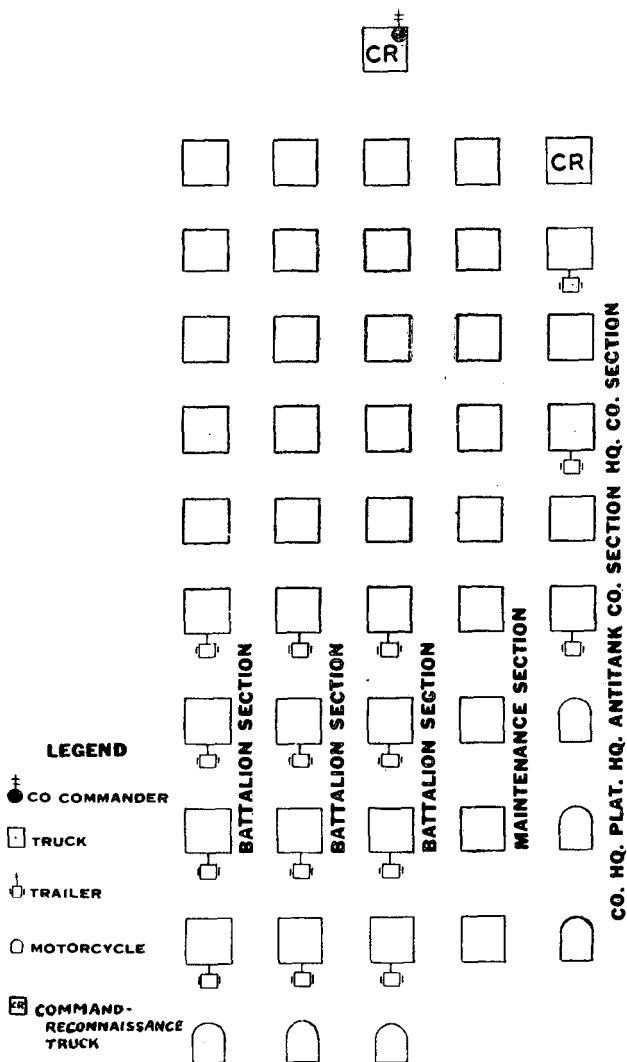

② Motorized elements in mass formation.  
 FIGURE 56.—Service company—Continued.

## SECTION V

## COMPANY DRILL

■ 206. GENERAL.—*a.* Weapons companies and other motorized units with 8 to 18 vehicles may be formed and drilled as a single unit. Units with large numbers of vehicles, such as service companies, are formed in several subdivisions based on the organization as shown in figure 56 ① and ②.

*b.* Drill as a company should be directed toward efficient and orderly formation and movement. The essential movements are—

(1) Movement into a mass or other designated formation from a single column.

(2) Movement in mass formation including changes in direction.

(3) Breaking into a single column from mass formation while moving and while at a halt.

*c.* For ceremonies, the formation and movements should be explained in advance.

■ 207. FORMATIONS.—*a.* Figures 53 to 58, inclusive, give several formations which may be used as a guide. The detailed arrangement of vehicles and the grouping of subdivisions may be modified to meet the requirements of each specific organization.

*b.* When the company commander is riding in formation in his vehicle, the guidon is flown therefrom. If the guidon is posted with the company commander dismounted, in line or mass formation, the guidon is 1 pace to his rear and 3 paces to his left. In the field it is disposed with the company headquarters' baggage or as otherwise directed.

■ 208. FORM COMPANY WITH PERSONNEL AND LOADS IN VEHICLES.—*a.* The men are formed as for foot troops, except that the drivers and other personnel connected with the operation of the vehicles, under the second in command or a designated commander, proceed to the vehicles and bring them to a convenient place for loading.

*b.* After the company has formed and reports have been received, the first sergeant with the platoon or other leaders arranges the subdivisions so as to conform to the number of vehicles. Extra men and small headquarters groups are attached to regular squads.



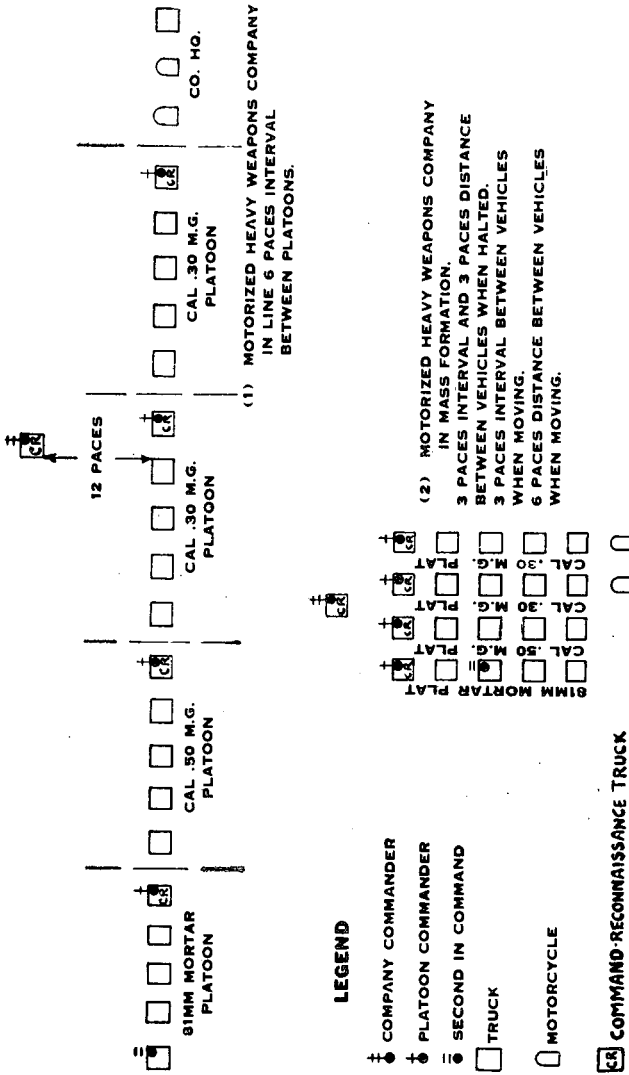
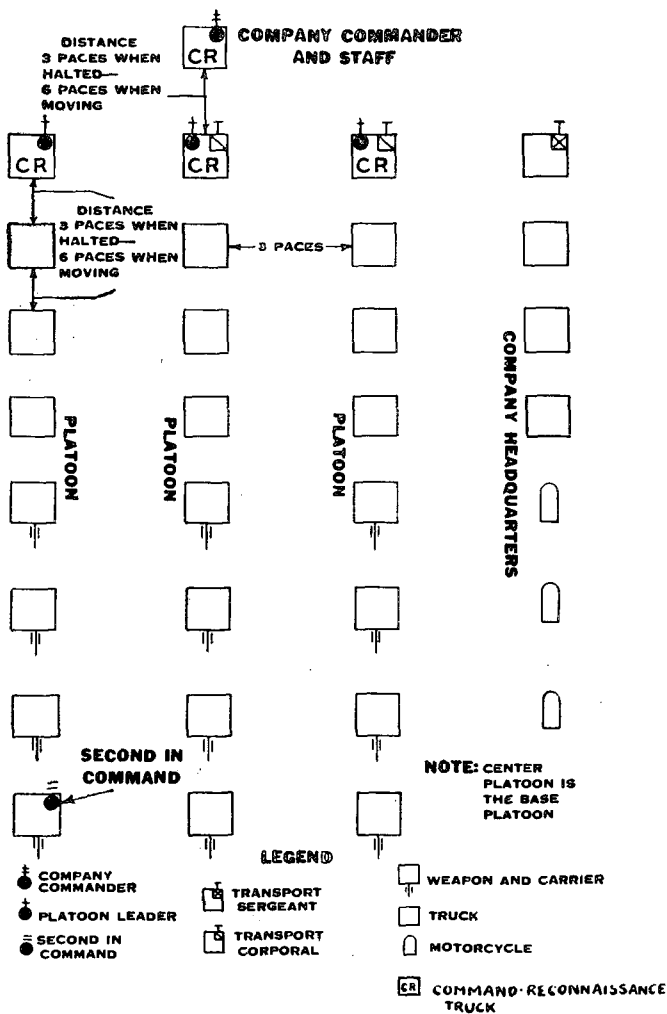

FIGURE 57.—Battalion heavy weapons company, motorized, in line and in mass formation.





⊙ In mass formation.

FIGURE 58.—Antitank company, motorized.—Continued.

■ 209. MOVEMENTS.—*a.* The company, if all vehicles are massed as one unit, drills as prescribed in section IV.

*b.* If the company is formed into several masses, the company commander gives instructions to the commander of the subdivisions of the company. The leading subdivision starts the movement and other subdivisions conform. The leading subdivision is responsible for maintaining the proper direction and speed. For ceremonies, the company commander places his car at the prescribed distance in front of the center of his company when in march or at a halt. For drill, he moves about so as best to observe the performance of his unit.

■ 210. DISMISS COMPANY.—*a.* The vehicles are unloaded and sent to the park under a designated officer. Transportation personnel remain with the trucks.

*b.* The remainder of the company may be called to attention, arms inspected, and squad leaders directed to store their equipment and dismiss their squads, or the company may be re-formed as for foot troops, marched to its camp or barracks, and then dismissed.

## CHAPTER 8

### FORMATIONS OF BATTALION AND REGIMENT

	Paragraphs
SECTION I. General .....	211-213
II. Battalion .....	214-217
III. Regiment .....	218-225

#### SECTION I

#### GENERAL

■ 211. GENERAL.—*a.* The regiment does not drill by command. Its battalions form and march as directed by the regimental commander. When practicable, the formation and movement of the subdivisions of the battalion and regiment should be made clear to subordinate commanders before starting the movement.

*b.* The battalion drills by command when in mass formation. Such drill is limited to movements for ceremonies where the units of the battalion execute the manual, facings, and marching as one body at the command of the battalion com-

mander. These movements are executed by the battalion as prescribed for the company.

*c.* The assembly of units in mass formation is directed by the battalion commander. Each company commander moves his company to its place in the most convenient manner.

*d.* To assume any formation, the battalion or regimental commander indicates the character of the formation desired, the point where the right (left) of the battalion or regiment is to be, and the direction in which the line or column is to face.

*e.* Upon completion of the movement ordered by the battalion commander, companies may be given AT EASE until another movement is ordered. In ceremonies, units remain at attention until ordered to stand at ease by the next higher commander.

*f.* After a battalion is halted, its subdivisions make no movement to correct alinement or position unless so directed by the battalion commander.

*g.* When a unit is presented to its commander or to a reviewing officer, the officer who presents it faces his unit in giving the commands: 1. PRESENT, 2. ARMS. When all elements of his unit are at PRESENT ARMS, he faces to the front and salutes (PRESENT SABER if armed with a saber, or the HAND SALUTE if armed with a pistol). His staff salutes and terminates the salute with him. His guidon or flag bearer (if any) executes and terminates PRESENT GUIDON with his salute.

*h.* Formations should be such that the squad columns are all either perpendicular to or parallel to the front.

■ 212. COMMANDS AND ORDERS.—The commands or orders of the battalion or regimental commander are given orally, by bugle, by signal, or by means of staff officers or orderlies who communicate the desired directions.

■ 213. STAFF.—*a.* The staff of a commander forms in his rear in one rank at a distance of  $1\frac{1}{2}$  paces, the second officer in line immediately in rear of the commander. Enlisted personnel form  $1\frac{1}{2}$  paces in rear of the commissioned staff. If only one officer is present, he is posted 1 pace to the right and  $1\frac{1}{2}$  paces to the rear of the commander. Staff officers are arranged from right to left generally in order of rank, the senior on the right, but the commander may cause them

to be arranged in any order desired by him. Enlisted personnel forming with the staff are posted in the same order from right to left as the officers of the staff, except that the bearer of a general officer's flag is on the right.

*b.* When necessary to reduce the front of the staff, as in marching, it forms a column of threes under the direction of the senior staff officer and follows the commander.

## SECTION II BATTALION

■ 214. FORMATIONS.—Formations for the battalion are shown in figures 59 to 62, inclusive.

*a.* The band, when attached to the battalion, is posted by the adjutant as indicated in figures 60 and 61.

*b.* Attached units take position as directed by the battalion commander and conform to the formation and movements of the units of the battalion.

*c.* In whatever direction the battalion faces, the companies are designated numerically from right to left in line and from head to rear in column; that is, first company, second company, third company.

*d.* The terms "right" and "left" apply to actual right and left as the troops face.

*e.* The designation "center company" indicates the right center or the actual center company, according to whether the number of companies is even or odd.

*f.* Personnel and vehicles of the battalion headquarters detachment may be attached to the weapons company for ceremonies.

*g.* The battalion commander supervises the formation from such positions as will best enable him to correct alignments, intervals, and distances. With his staff (less the adjutant) he takes post in time to receive the report.

*h.* Officers armed with a saber in the interior of a mass formation remain at CARRY SABER at all times except when the battalion is at rest or at ease.

*i.* Any formation or combination of formations may be employed to meet existing conditions of space or purpose.

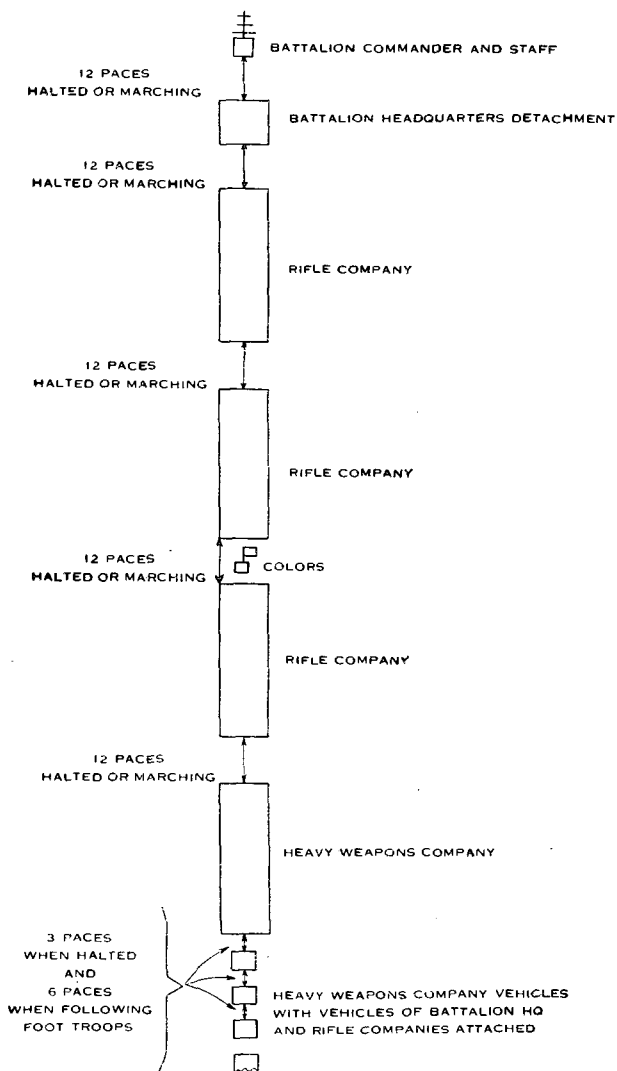
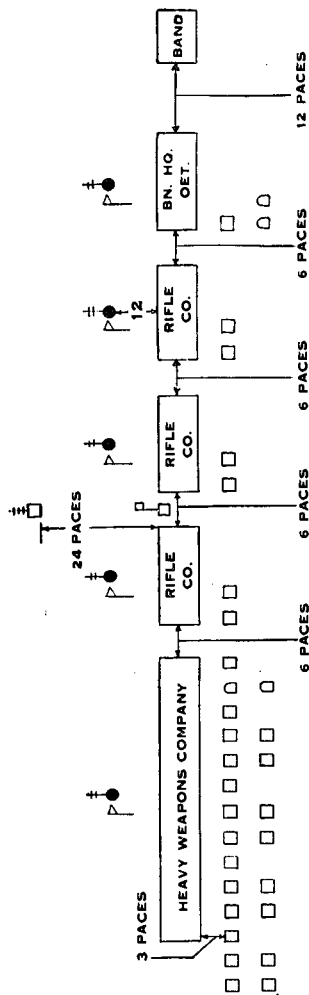

FIGURE 59.—Battalion in column.



**LEGEND**

- † □ BATTALION COMMANDER AND STAFF
- † ● COMPANY COMMANDER
- P □ COLORS
- P □ GUIDON
- TRUCK OR CAR
- MOTORCYCLE

**FOR DRILL CEREMONIES AND MARCHES.  
THE COMPANY TRUCKS MAY BE ATTACHED TO  
THE HEAVY WEAPONS COMPANY.**

FIGURE 60.—Battalion in line with companies in line.



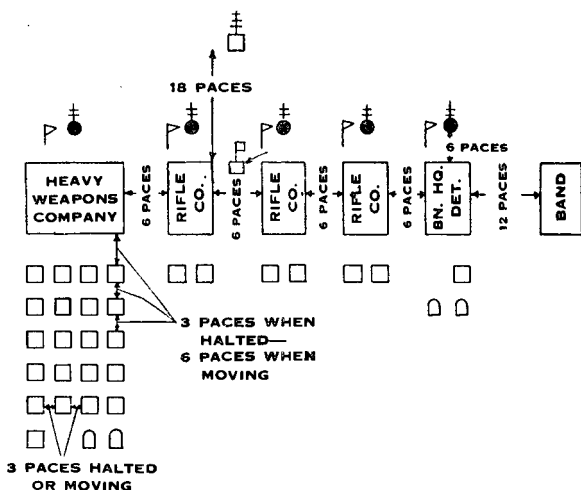

**RIFLE COMPANY MAY FORM AND MARCH WITH 3 TO 6 PACES INTERVAL BETWEEN PLATOONS TO MAKE THE MASS APPEAR LARGER. FOR DRILL CEREMONIES AND MARCHES. THE COMPANY TRUCKS MAY BE ATTACHED TO THE HEAVY WEAPONS COMPANY. BATTALION HEADQUARTERS DETACHMENT MAY BE ATTACHED TO THE WEAPONS COMPANY**

**LEGEND**

- COMPANY COMMANDER AND STAFF
- COMPANY COMMANDER
- COLORS
- GUIDON
- TRUCK OR CAR
- MOTORCYCLE

FIGURE 61.—Battalion in line with companies in mass formation

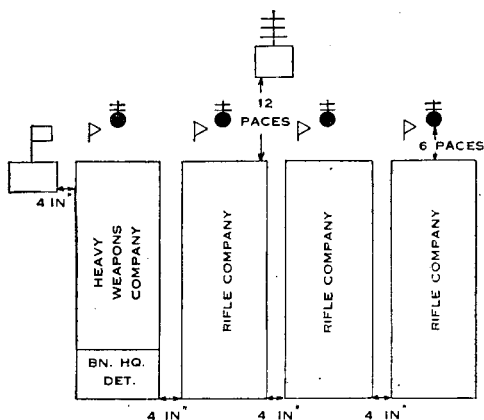

EACH COMPANY IN COLUMN AT CLOSE INTERVAL WITHOUT DISTANCE BETWEEN PLATOONS.

COMPANIES FORM ABREAST WITHOUT INTERVAL. (FOR A WIDER FRONTAGE COMPANIES MAY FORM WITH THREE PACES INTERVAL.)

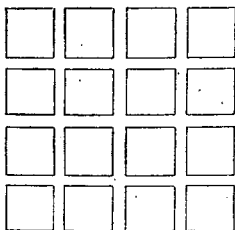
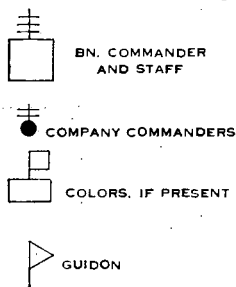

VEHICLES OF HEAVY WEAPONS COMPANY WITH BN. HQ. AND RIFLE CO. VEHICLES ATTACHED VEHICLES ARE 3 PACES BEHIND REAR OF FOOT ELEMENTS WHEN HALTED AND 6 PACES WHEN MOVING. 3 PACE INTERVALS AND 3 PACE DISTANCES ARE MAINTAINED BETWEEN VEHICLES WHEN HALTED. THREE PACE INTERVALS AND SIX PACE DISTANCES ARE MAINTAINED BETWEEN VEHICLES WHEN MOVING.

FIGURE 62.—Battalion in mass formation.

■ 215. FORM IN LINE WITH COMPANIES IN LINE (FOR CEREMONIES).—*a.* The adjutant indicates the line on which the battalion is to form with two flags, one on each flank. The adjutant takes post on the right of the line and facing down the line.

*b.* When the band is present, the adjutant causes *Adjutant's Call* to be sounded.

*c.* Companies are marched from the left flank in column of threes (or fours) to their positions in line, the line of march being sufficiently off the line on which the battalion is to form to permit the expeditious alinement of guides of the right company by the adjutant. As each company arrives at its position, it is halted (taking care to halt in rear of the position it is to occupy), faced to the front, and the company commander orders, GUIDES ON THE LINE. At this command, the guide of each platoon moves (at the trail) to his position on the line indicated by the flags and faces the adjutant. The adjutant will aline the guides of the right company accurately; the guides of other companies will cover accurately the guides already on the line, the guides indicating the right of their respective platoons. As soon as the guides have established themselves on the line, the company is alined as prescribed in paragraph 153. The right man of the front rank places himself so that his chest touches the guide.

*d.* When all units have reached their positions on the line, the band stops playing and the adjutant moves by the most direct route to a position midway between the battalion and the battalion commander and faces the battalion.

*e.* When all units are dressed, the adjutant commands: 1. GUIDES, 2. POST. At this command, the guides move to their normal position in ranks.

■ 216. FORM IN LINE WITH COMPANIES IN MASS FORMATION (FOR CEREMONIES) (fig. 61).—The procedure is the same as in forming in line except that—

*a.* Companies are marched from either flank in mass formation to their position in line, the line of march being well in rear of the line on which the battalion is to form. When opposite its place in line, each company executes LEFT (RIGHT) **[TURN**. As soon as this column movement has been initiated the company commander orders, GUIDE OF RIGHT PLATOON ON

**THE LINE.** At this command, the guide of the right platoon moves out at the double time to the line indicated by the flags, halts, comes to the order arms, and faces the adjutant. The guide indicates the right of the company.

b. At the command 1. GUIDES, 2. POST, the guides move to their normal positions.

■ 217. **DISMISS BATTALION.**—The battalion commander commands: **DISMISS YOUR COMPANIES.**

a. Each company commander salutes the battalion commander and marches his company to the place of dismissal and dismisses it as prescribed in paragraph 152.

b. The battalion commander then dismisses the staff, including enlisted personnel.

### SECTION III

#### REGIMENT

■ 218. **COLUMN WITH BATTALIONS IN COLUMN OF THREES OR FOURS (fig. 63).**—For marches, vehicles are grouped and follow the regiment or move as a separate detachment at normal motor speed.

■ 219. **COLUMN WITH BATTALIONS IN MASS FORMATION.**—See figure 64.

■ 220. **LINE OF BATTALIONS.**—The battalions may be—

a. In mass formation (fig. 65).

b. In line of company masses (fig. 66).

■ 221. **VARIATION IN FORMATION.**—a. Motor vehicles of weapons units may be grouped into one mass.

b. The weapons companies may be grouped into a provisional battalion.

c. Motor vehicles may form in rear of foot troops.

■ 222. **FORM REGIMENT.**—a. The regimental commander prescribes the formation, whether it will be with or without vehicles, the place where the regiment is to form, the direction in which the regiment will face, the hour of forming, location of head of column (or right of the line), and the order in column or line of the headquarters, band, battalions, special and attached units, and trains.

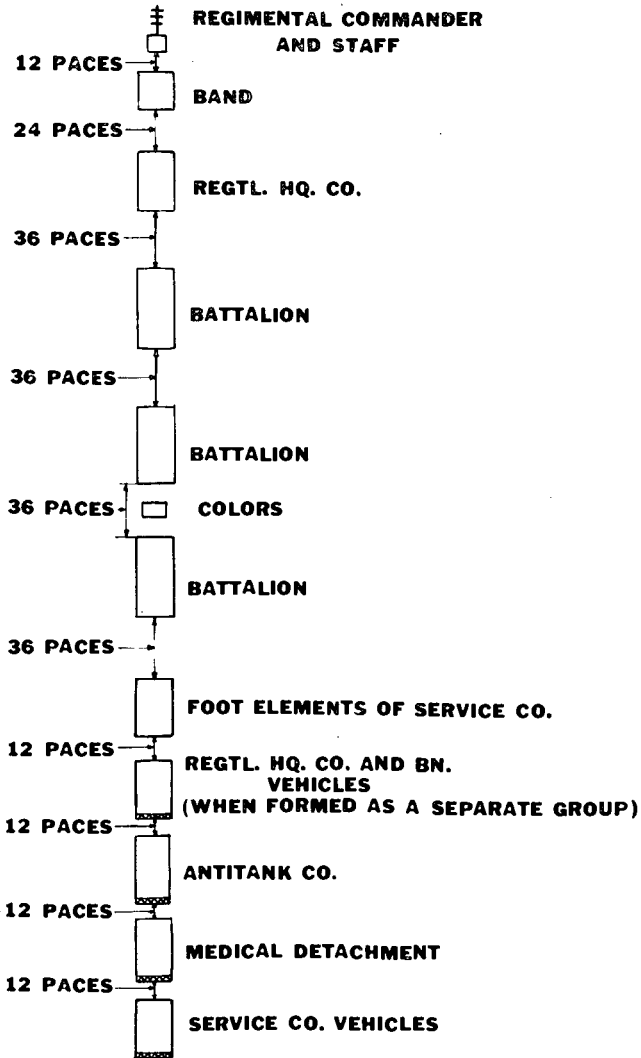

FIGURE 63.—Regiment in column with battalions in column of threes or fours.

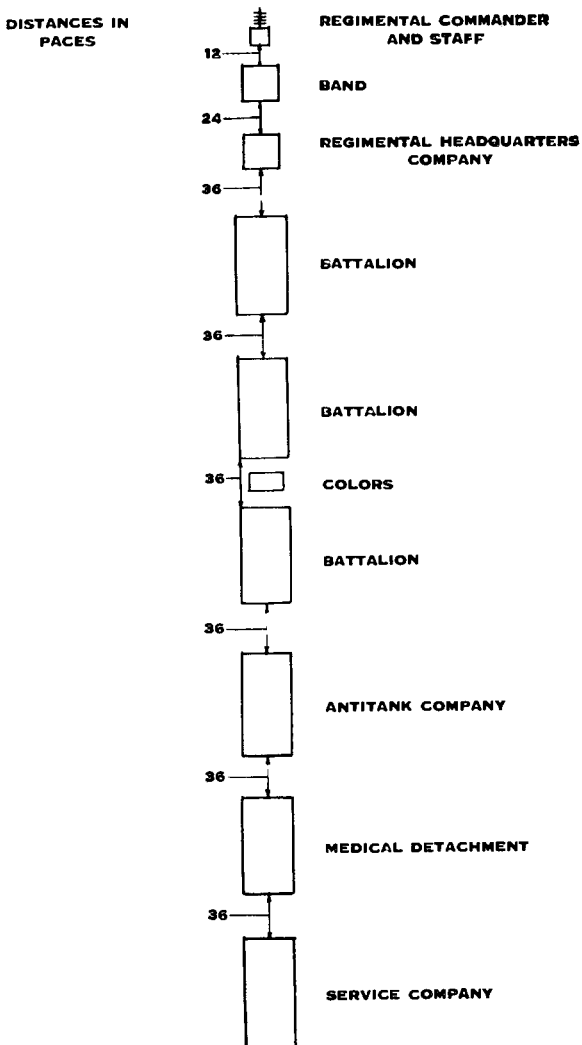
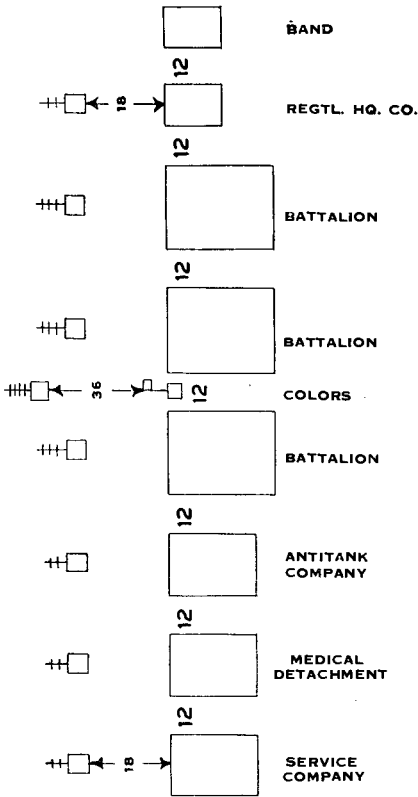

FIGURE 64.—Regiment in column with battalions in mass formation.



NOTE:  
INTERVALS  
AND DISTANCES  
SHOWN IN PAGES

LEGEND

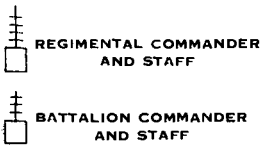
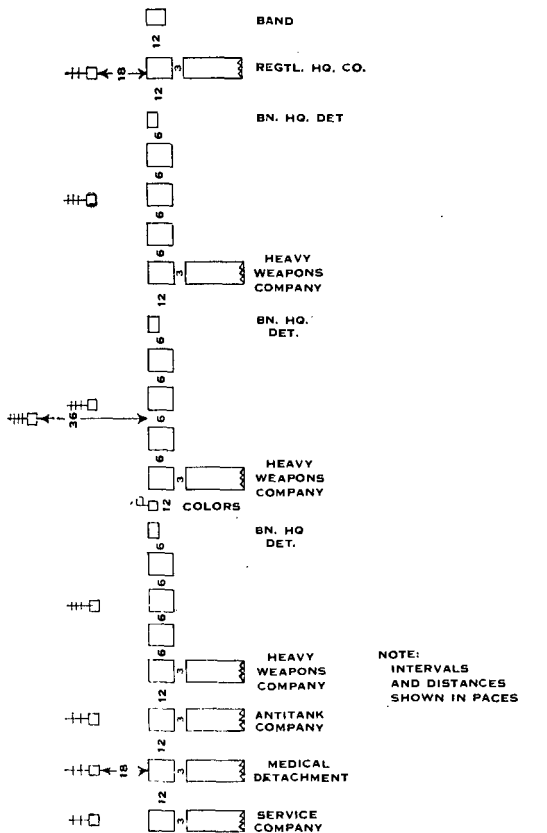

FIGURE 65.—Regiment in line with battalions in mass formation.



**LEGEND**

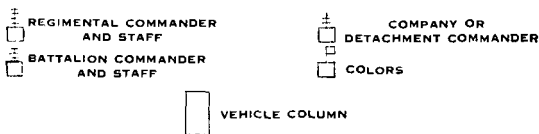

FIGURE 66.—Regiment in line with companies in mass formation.



b. The regimental commander gives his orders either orally or in writing. They may be given directly to the officers concerned or may be communicated to them through his staff.

c. Before forming the regiment, the regimental commander may cause the positions which are to be taken by the larger elements to be indicated by markers.

d. Battalion commanders and commanders of special and attached units move their commands to the place of formation and dispose them as ordered.

e. Upon arrival at their designated places in the prescribed formation, battalion and special unit commanders report the fact to the regimental commander; if units are combined, the commander thereof reports the arrival of the combined units at their designated place.

f. Battalions and special units are given rest upon arrival at their designated places.

g. For ceremonies, the procedure as described for the formation of a battalion is followed except that battalion adjutants take post on the line on which the regiment is to form at *Adjutant's Call*. Battalion adjutants face down the line from position 6 paces from the point where the right flank of each battalion will rest. When all units of their battalions are on line they move to their posts by the most direct routes.

■ 223. MARCH.—a. The regiment being in any formation, the regimental commander prescribes the formation in which the regiment will march and the route to be followed and puts the command in motion by prescribing the hour, by giving the commands, 1. FORWARD, 2. MARCH, by bugle, or by signal.

b. To march in route column, the regiment is not usually formed and put into march as a unit. Battalion commanders and special and attached unit commanders are informed in orders of the destination, route, hour of starting, initial point, order of march, and, if necessary, the distance between elements. They are held responsible for having their commands take their places in the column at the prescribed times and places.

c. The regiment may be formed for march in route column with the foot elements of the different types of platoons and companies in columns of threes or fours in accordance with the formations indicated in figures 36 and 45. If require-

ments of road space, air defense, or other considerations render it desirable, the foot elements of all platoons and companies within the regiment may be formed in column of threes, in column of twos on one side of the road, or in column of twos with single files on each side of the road.

■ 224. **HALT.**—To halt the regiment, the regimental commander may either prescribe the hour when the column will be halted or he may give the command or signal **HALT**.

■ 225. **DISMISS REGIMENT.**—To dismiss the regiment, the regimental commander orders the battalion and special and attached unit commanders to dismiss their organizations. The order may be given directly to the commanders concerned or it may be communicated to them through staff officers or messengers.

## CHAPTER 9 CEREMONIES

	Paragraphs
SECTION I. Reviews and presentation of decorations.....	226-234
II. Escorts .....	235-236
III. Parades.....	237-238
IV. Inspections .....	239-242
V. Funerals.....	243-254

### SECTION I

#### REVIEWS AND PRESENTATION OF DECORATIONS

■ 226. **ELEMENTS OF A REVIEW.**—A review consists of four parts:

- a. Formation of troops.
- b. Presentation and honors.
- c. Inspection (passing around the troops).
- d. March in review.

■ 227. **COMMANDER OF TROOPS.**—The senior officer present in the ceremony is designated as commanding officer of troops. He is responsible for the formation, presentation, and march in review. A commander reviewing his own troops designates some other officer as commanding officer of troops. When the review is given for a visiting higher commander or civilian dignitary, the local commander designates a commanding officer of troops so that he may accompany and receive the review with the visitor.

■ 228. PREPARATIONS.—The line on which the troops are to form and along which they are to march is marked out or otherwise designated. The post of the reviewing officer is marked with a flag which will be placed opposite the center of the line of troops. (See fig. 67.)

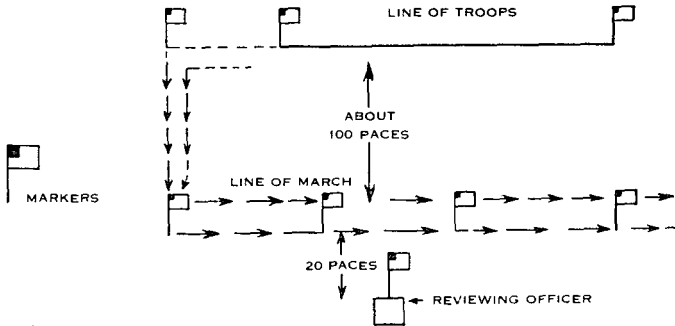

[FIGURE 67.—To illustrate paragraph 228.

■ 229. FORMATIONS.—*a.* Any of the formations prescribed for the battalion or regiment may be used. Such formation may be modified to meet the local situation. The formation used depends on the space available and the formation in which the units are to pass in review. When practicable, the formation selected should have all squad columns either perpendicular or parallel to the line on which the troops form.

*b.* In reviews of a regiment or larger group, especially when troops pass in review in mass formation, special arrangements are made to provide for breaking up into march columns after troops have passed the reviewing officer. This may be done by assigning areas which do not block the line of march into which different units can move while still in mass formation.

*c.* When a review is held at retreat, as soon as the troops are formed and brought to present arms, the commander of troops commands: **SOUND RETREAT** (or gives a signal to the band or bugles). The bugles sound retreat and immediately afterward the band plays the *National Anthem* (if no band is present the bugles sound *To the Color*). When the evening parade is held on an Army post, the evening gun is

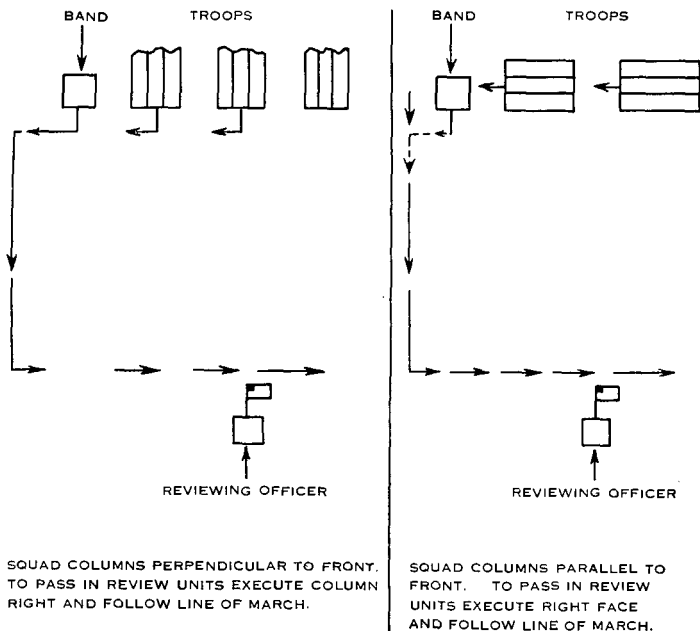

FIGURE 68.—To illustrate paragraph 229.

fired at the last note of retreat and the post flag is lowered as the band plays the *National Anthem*.

d. The commanding officer of troops remains facing the troops and salutes at the first note of the *National Anthem*. At the last note of the *National Anthem* he faces the reviewing officer and salutes him. The reviewing officer returns the salute. The commanding officer of troops brings the troops to **ORDER ARMS** and the ceremony proceeds.

230. FORMATION FOR REVIEW.—a. Battalions and regiments are formed as prescribed. In reviews in which two or more arms are present the troops are arranged as directed by the commander of troops. The following order, from right to left in line, may be used as a guide: infantry regiments and other units which contain foot troops; horse cavalry; horse artillery; motorized artillery; tanks and mechanized cavalry;

motorized service units. In each category the units are arranged in order of the rank of their commanders.

b. Troops move to position in the most convenient manner. In large reviews, the commanding officer of troops prescribes the routes and time of arrival. If the frontage of units has been measured and marked, they may arrive in any convenient order and occupy their place in line. If this is not done, units must form successively from the right. The former method is preferable in large mixed commands.

c. When commanders are mounted in motor vehicles, they dismount and take posts as prescribed or as directed from the time their units arrive on the line until the command, **PASS IN REVIEW**.

d. (1) When all units are formed and alined, the troops are presented to the commander of troops by a designated staff officer. The commander of troops and his staff take position so as to be in front of the post of the reviewing officer, midway between the line of the next lower commanders in the formation and the post of the reviewing officer if not already in such position.

(2) If the formation contains more than one regiment, the regimental commanders direct their regiments to present arms starting with the center (or right center) regiment and continuing simultaneously toward both flanks. If the formation consists of a single regiment, the same principle is followed. Battalions execute **PRESENT ARMS**, **ORDER ARMS**, or other movements of the manual at the commands of the battalion commanders. If the formation consists of a single battalion, it presents arms at the command of the adjutant.

(3) The commander of troops returns the salute of the staff officer who presented the command and directs him to take his post. He then draws saber (if so armed) and brings the command to the order and gives **REST OR AT EASE**. The commander of troops and his staff then form so as to face the post of the reviewing officer.

(4) Staff and orderlies salute only when the command is presented to the reviewing officer. At other times they stand at attention at **ORDER ARMS**.

■ **231. REVIEWING PARTY.**—*a.* When the formation has been completed, the reviewing officer with his staff and orderlies moves to his position opposite the center of the line of troops to receive the review.

b. The local commander (if not acting as commander of troops), distinguished civilians invited to accompany the reviewing officer, staffs, and enlisted personnel take positions facing the troops as shown in figure 69 with 1½ paces distance between ranks. When an organization is to be reviewed before an inspecting or other officer junior in rank to the local commander, the latter takes position on the left of the local commander.

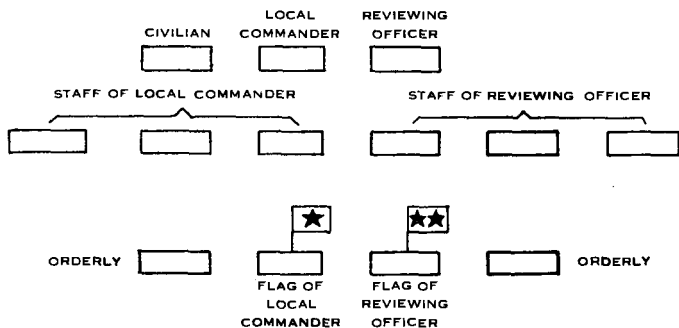

FIGURE 69.—Reviewing party.

c. An officer from the local staff is designated to escort distinguished civilians and to indicate to them their proper places. If a civilian is to receive the review, he takes position on the right of the local commander and, if necessary, timely explanation of the ceremony is made to him. The reviewing party is mounted only when the commander of troops is likewise mounted. When the commander of troops is in a motor vehicle, the reviewing officer receives the review on foot.

■ 232. PRESENTATION AND HONORS.—a. As the reviewing officer moves to his position, the commander of troops brings his command to attention. Troops come to attention at the commands of their respective battalion commanders.

b. When the reviewing officer is in position, the commander of troops faces his troops and directs PRESENT ARMS, which is executed in the same manner as prescribed in paragraph 230. When all units have come to PRESENT ARMS, he turns about and salutes the reviewing officer. His staff and orderlies [salute with him. The band (or a designated band near the

[center of the command, if more than one band is present) For field music then sounds the honors. When the honors are completed, the commander of troops terminates his salute (his staff conforming) and brings the troops to ORDER ARMS. If the formation consists of more than one battalion, he orders AT EASE.

**[c.** When artillery is present in the review and when the commander of troops deems it practicable, a salute may be fired. The first gun is fired with the first note of the honors. The detachment firing the salute rejoins its unit after the salute is fired. The salute may be fired for those entitled to a gun salute in addition to the salute provided in AR 600-25 for visiting officials. Its use should be limited to special ceremonial occasions and when the presence of civilian spectators makes desirable an especially impressive ceremony.

**[d.** When the grade of the reviewing officer entitles him to the honor, each regimental color salutes with its command.

**[e.** The reviewing officer, his staff, and all military spectators salute at the first note of the music and retain the salute until music and gun salute are completed.

**[f. Honors.**—The officials named below will be rendered salutes and honors as follows:

	Guns, salute	Ruf- fles and flour- ishes	Music	Paragraph reference, AR 600-30
President.....	21	4	National Anthem	2a.
Ex-President.....	21	4	March.....	2c.
Chief magistrate or sovereign of a foreign country.	21	4	National Anthem	2b.
Members of a reigning royal family.	21	4	National Anthem	2b.
Vice President.....	19	4	March.....	2c.
American or foreign ambassa- dor.	19	4	National Anthem	2e (1) (b).
High commissioner or other diplomatic officer equal or superior to an ambassador.	19	4	National Anthem	2e (1) (b).
High commissioner to the Commonwealth of the Phil- ippine Islands.	19	4	National Anthem	2e (1) (c).
President of the Common- wealth of the Philippine Is- lands.	19	4	National Anthem	2e (1) (c).

	Guns, salute	Ruf- fles and flour- ishes	Music	Paragraph reference, AR 600-30
Secretary of War.....	19	4	March.....	2e (1) (a).
Members of the Cabinet.....	19	4	March.....	2e (1) (a).
President pro tempore of the Senate.	19	4	March.....	2e (1) (d).
Governor of a State.....	19	4	March.....	2e (1) (g).
The Chief Justice.....	19	4	March.....	2e (1) (c).
General of the Armies.....	19	4	General's March..	2d (1) and (2) (a).
Assistant Secretary of War.....	17	4	March.....	2e (1) (i).
Assistant Secretary of the Navy.	17	4	March.....	2e (1) (j).
Governors of Territories or foreign possessions within the limits of their respective jurisdictions.	17	4	March.....	2e (1) (h).
Speaker of the House of Repre- sentatives.	17	4	March.....	2e (1) (e).
A committee of Congress.....	17	4	March.....	2e (1) (f).
Chief of Staff.....	17	4	General's March..	2d (1) and (2) (a).
Former Chief of Staff.....	17	4	General's March..	2d (1) and (2) (a).
General.....	17	4	General's March..	2d (1) and (2) (a).
Vice Governor of the Philip- pine Islands.	15	3	March.....	2e (2).
American envoys or ministers and foreign envoys or minis- ters accredited to the United States.	15	3	March.....	2e (2).
Lieutenant general.....	15	3	General's March..	2d (1) and (2) (b).
Major general.....	13	2	General's March..	2d (1) and (2) (c).
American ministers resident and ministers resident accred- ited to the United States.	13	2	March.....	2e (3).
American chargés d'affaires and chargés d'affaires accred- ited to the United States.	11	1	March.....	2e (4).
Brigadier general.....	11	1	General's March..	2d (1) and (2) (d).
Consuls general accredited to the United States.	11			
Consuls accredited to the United States.	7			
Vice consuls or consular agents accredited to the United States.	5			



■ 233. INSPECTION.—*a.* The reviewing officer and his party move forward to the commander of troops. The two exchange salutes. Staffs do not salute. The commander of troops then conducts the reviewing party around the formation, beginning with the unit on the right of the line and passing in front of the line and then back around the rear of the formation. While passing around the troops, the reviewing officer may direct that his staff, flag, and orderlies remain at the post of the reviewing officer, or that only his personal staff and flag accompany him. The commander of troops and the local commander accompany the reviewing officer while he passes around the troops and march on that side of the reviewing officer which is away from the troops. The staffs of the commander of troops, of the local commander (if present), and of the reviewing officer follow, each staff following its own commander in column of files. In passing around the troops, the staffs maintain the formation in which they commence their march. If the inspection is to be made in motor cars, the reviewing party enters cars which drive up to the post of the reviewing officer after completion of the honors. One seat in each car on the side away from the troops during the inspection is left vacant. The cars move to the post of the commander of troops. The commander of troops enters the car with the reviewing officer. A staff officer enters each of the other cars. Orderlies and flag remain at their posts.

*b.* The reviewing officer makes such general inspection of the command as he may desire while passing around the troops. A detailed inspection is not a part of the ceremony of review.

*c.* The band of an organization plays while the reviewing officer is in front or rear of the organization.

*d.* If the formation is standing at ease, each company or massed unit is brought to attention as the reviewing party approaches.

*e.* As the reviewing party approaches each front line company or battalion (if the battalion is in mass formation), its commander gives the commands, 1. EYES, 2. RIGHT. The men execute EYES RIGHT and as soon as the reviewing officer comes into their line of vision they follow him with their eyes, turning the head, until the reviewing officer reaches their

front when the head and eyes of each man, individually, remain fixed to the front.

*f.* On arriving again at the right of the band after passing around the line, the commander of troops salutes the reviewing officer and halts (or dismounts from his car). The reviewing officer and the commander of troops with their staffs then return to their respective posts.

■ 234. MARCH IN REVIEW.—*a.* When the reviewing party is again in place, the commander of troops commands: **PASS IN REVIEW**. At the command **PASS IN REVIEW**, the band of the right unit changes direction, if necessary, and halts.

*b.* When the band has halted, the commander of the unit next to the band gives the command to put the troops in march in the formation designated for the review. Troops pass in review in quick time only.

*c.* Other units move out in succession so as to follow at the prescribed distance.

*d.* The band and each unit change direction at the points indicated without command from the commander of troops. At each change of direction the commander of each mass formation (company or battalion) in turn commands: 1. **LEFT TURN**, 2. **MARCH**, 3. **FORWARD**, 4. **MARCH**. The third and fourth commands are given so that the unit steps off at full step when the change of direction is completed.

*e.* Regimental commanders and battalion commanders move into position in the column at the head of their troops after the first change of direction.

*f.* The commander of troops moves into position at the head of the column after the second change in direction.

*g.* Each commander, when he arrives 6 paces from the front of the reviewing officer, salutes. He terminates the salute when his staff has passed 6 paces beyond the reviewing officer. His staff salutes and terminates the salute with him.

*h.* Each band executes **COLUMN LEFT** when it has passed the reviewing officer. It executes a second **COLUMN LEFT** and a third **COLUMN LEFT** so as to place the band in front of and facing the reviewing officer and at least 12 paces from the left flank of the marching troops. It continues to play until the regiment has passed. It then ceases playing and follows in rear of its regiment. The band of the following regiment

commences to play as soon as the preceding band has ceased. In large commands, two bands may remain alongside of each other after they have turned out of column to alternate in playing the troops by. Such an arrangement is necessary to rest the musicians if the playing of march music is to be long continued. In large commands, bands may be massed and posted as directed by the commander of troops as another alternative.

*i.* Each company commander (or the senior company commander if the battalion is in mass formation), when 6 paces from the front of the reviewing officer, without turning his body, commands: 1. EYES, 2. RIGHT; 3. READY, 4. FRONT. He gives the command RIGHT when he is 6 paces from the front of the reviewing officer, and the command FRONT when the rear of his unit has passed 6 paces beyond the reviewing officer. He brings his saber to the first position of PRESENT SABER at the command EYES and to the second position at the command RIGHT. He resumes the carry at the command FRONT. In each company or mass formation the men on the right do not execute EYES RIGHT.

*j.* When passing in review, at the commands 1. EYES, 2. RIGHT, the following salute:

(1) The officer who gives the command and his staff execute PRESENT SABER (OR HAND SALUTE if armed with pistol). Orderlies execute HAND SALUTE. Guidon or flag bearers execute PRESENT GUIDON. They all terminate the salute (or come to carry saber or guidon) with the commander.

(2) In battalion mass formation at the commands 1. EYES, 2. RIGHT, company commanders and officers in the front rank of the mass execute PRESENT SABER (OR HAND SALUTE if armed with pistol). No other salute.

(3) In a company not part of a battalion, mass formation platoon leaders execute PRESENT SABER (OR HAND SALUTE if armed with pistol).

(4) All terminate the salute at the command FRONT. Those with saber or guidon return to the carry.

(5) The band leader and the drum major execute and terminate the salute at the points prescribed for other commanders.

(6) If the reviewing officer is entitled to a color salute, the regimental color salutes when at 6 paces from his front and is raised when at 6 paces beyond him.

*k.* Troops march in review with the guide toward the flank on which the reviewing officer is posted.

*l.* After saluting the reviewing officer in passing in review, the commander of troops turns out of the column and takes post on the side of the reviewing officer toward the direction of march of the command, and returns saber. The members of his staff accompany him, take post on the corresponding side of the reviewing officer's staff, and return saber with him. When the rear element of his command has passed, the commanding officer of the troops, without changing his position, salutes the reviewing officer with the hand salute. He and the members of his staff then rejoin the command. If the person reviewing the command is not mounted, the commanding officer and his staff, on turning out of the column after passing the reviewing officer, dismount preparatory to taking post. In such case the salute of the commanding officer, prior to rejoining his command, is made before remounting. If the commanding officer and his staff are in motor cars, the cars are parked on the side of the reviewing officer toward the direction of march and in rear of the lines occupied by the reviewing officer, the commanding officer, and their staffs.

*m.* All individuals at the reviewing stand salute the color as it passes. When passing around the troops, the reviewing officer and those accompanying him salute the color when passing in front of it.

*n.* The reviewing officer returns the salute of the commanding officer of the troops and the salutes of subordinate commanders down to include the battalion commanders. Those who accompany the reviewing officer do not salute.

*o.* A review is ordinarily held on occasions of the presentation of decorations or of the decoration of the colors. After the reviewing officer has passed around the line and resumed his post, the commanding officer of the troops from his own post commands (or orders, or signals): **1. PERSONS TO BE DECORATED AND ALL COLORS, CENTER, 2. MARCH.** At the command **MARCH**, persons to be decorated and all colors move by the most direct route and take post as follows:

(1) The persons to be decorated in a single rank in the center of the command and 10 paces in front of the line of company commanders according to the rank of the decora-

tions to be conferred. Those receiving similar awards take position in accordance with their military rank.

(2) Colors to be decorated in single rank 5 paces in front of the center of the line of persons to be decorated in groups according to rank of decoration to be bestowed, highest ranking decoration on the right.

(3) All other colors with color guards in single rank 5 paces in rear of the center of the persons to be decorated and in the same relative position as their location in the command.

(4) The commander of troops takes post 5 paces in front of the center of the leading element. He then commands: 1. FORWARD, 2. MARCH. At the command MARCH, the commanding officer, the persons to be decorated, and the colors advance, the band playing. The commander of troops marches on the reviewing officer. In all ranks the guide is center. The detachment is halted by the commander of troops when he has reached a point 10 paces from the reviewing officer by the commands: 1. DETACHMENT, 2. HALT. He then salutes the reviewing officer and reports, "Sir, the persons (colors) to be decorated are present." The reviewing officer returns the salute and directs that the command be presented. The commander of troops returns to his post in front of the center of his command by moving around the right flank of the persons or colors to be decorated and then directly to his post. On reaching his post he commands: PRESENT ARMS, faces about, and salutes. The band then plays the *National Anthem*. If only field music is present, it sounds *To the Color*. On completion of the music, the commanding officer of the troops brings the command to the order. If the formation consists of more than one battalion, he directs AT EASE. The persons to be decorated salute and terminate the salute at the commands of PRESENT ARMS and ORDER ARMS given by the commander of troops.

(5) A designated staff officer then reads the order announcing the awards. After the reading of the order, the reviewing officer, accompanied if necessary by his staff or designated members thereof, advances to the colors and to the line of persons to be decorated, fastens the appropriate streamer to the staff of the color, and pins the decoration awarded on the left breast of each person. He then directs the commanding officer of the troops to march the command in review and

resumes his post. The persons decorated form line on the left of the reviewing officer or as otherwise directed, and the colors return to their posts by the most direct route.

## SECTION II

### ESCORTS

■ 235. ESCORT OF THE COLOR.—*a.* The regiment being in line, the regimental commander details a company to receive and escort the national color to its place. For this ceremony the regimental color forms with the color guard at its post with the regiment.

*b.* The band moves straight to its front until clear of the line of battalion commanders, changes direction if necessary, and halts. The designated company forms columns of threes or fours 15 paces in rear of band with the color bearer in rear of leading platoon. The escort then marches without music to the regimental commander's office or quarters and forms line facing the entrance. The color bearer, preceded by the senior lieutenant and followed by a sergeant of the escort, obtains the color.

*c.* When the color bearer returns, followed by the lieutenant and the sergeant, he halts before the entrance, facing the escort. The lieutenant places himself on the right and the sergeant on the left of the color bearer. The escort then presents arms and the field music sounds *To the Color*. The lieutenant and the sergeant salute at the command of the company commander. Arms are brought to the order; the lieutenant and the sergeant return to their posts. The company is formed in column, the band taking post in front of the column. The color bearer places himself in the center of the space in rear of the leading platoon. The escort then marches back to the regiment, the band playing. The march is conducted so that the escort arrives at a point about 50 paces in front of the right of the regiment and then passes parallel to its front. When the color arrives opposite the center of the regiment, the escort is formed in line facing the regiment. The color bearer moves to a position 6 paces in front of the regimental commander.

*d.* The color bearer having halted, the regimental commander, who, prior to the arrival of the color bearer, has taken post 30 paces in front of the center of the regiment,

turns about and brings the regiment to PRESENT ARMS. The regimental commander then turns to the front and salutes. The field music sounds *To the Color* when the regimental commander salutes. The regimental commander then turns about and brings the regiment to the order and the color bearer moves to his post beside the regimental color bearer. The escort executes PRESENT ARMS and ORDER ARMS at the command of its commander who then forms it in column to the right and, preceded by the band, marches it to its place, passing around the left flank of the regiment. The band plays until the escort passes the left of the line. The band then returns to its post on the right, passing in rear of the regiment. The regiment may be given the command REST when the escort passes the left of the line.

e. Escort of the color is executed by a battalion according to the same doctrines as for a regiment.

■ 236. ESCORT OF HONOR.—a. Escorts of honor are detailed for the purpose of receiving and escorting personages of high rank, civil or military. The troops detailed for this duty are selected for their soldierly appearance and superior discipline.

b. The escort forms in line, opposite the place where the personage is to present himself, the band on the flank of the escort toward which it is to march. On the appearance of the personage, the escort will be brought to attention and, when he has taken position from which to receive them, the honors due his rank will be rendered. Ordinarily the person so honored will inspect his escort. The escort then forms column and takes up the march. The personage with his staff or retinue takes position in rear of the column. When the personage leaves the escort, line is again formed, and, when he has taken position from which to receive them, the same honors are rendered as on his arrival.

c. When the position of the escort is at a considerable distance from the point where the personage is to be received, for instance, where a courtyard or wharf intervenes, a double line of sentinels, facing inward, is posted from that point to the escort. The sentinels successively salute as the personage passes.

d. An officer is designated to accompany the personage.

## SECTION III

## PARADES

■ 237. REGIMENT OR BATTALION.—*a.* The regimental or battalion parade is the same as a review except that the appearance and movement of troops in formation are the primary considerations. For this reason the troops usually form without heavy weapons or transportation, and all companies form and execute the movements prescribed for foot troops. Small headquarters companies and detachments are attached to larger units. The march to the initial formation is made to music (band, bugles, or drums). Escort of the color (par. 235) or the presentation of decorations (par. 234o) may be included after the troops have been presented to the reviewing officer.

*b.* At evening parade, as soon as the troops are formed and brought to present arms, the commander of troops commands: SOUND RETREAT (or gives a signal to the band or bugles). The bugles sound *Retreat* and immediately afterward the band plays the *National Anthem* (if no band is present the bugles sound *To the Color*). When the evening parade is held on an Army post, the evening gun is fired at the last note of retreat and the post flag is lowered as the band plays the *National Anthem*.

*c.* The commanding officer of troops remains facing the troops and salutes at the first note of the *National Anthem*. At the last note of the *National Anthem* he faces the reviewing officer and salutes him. The reviewing officer returns the salute. The commanding officer of troops brings the troops to ORDER ARMS and the ceremony proceeds as for a review except that the reviewing officer does not inspect or pass around the troops.

■ 238. STREET.—*a.* For street parades, troops are formed and marched in the most convenient manner. Street parades may include transportation. Weapons transportation with the weapon towed or set up in the vehicles when practicable adds to the effect of a street parade. Cargo vehicles are included only when it is desired to increase the size of the display.



b. Among the formations which may be used for street parades are columns of threes or fours; two or more columns of threes or fours abreast; mass formation.

c. Transportation marches in single column or column of twos, threes, or fours as the street width permits.

d. In long street parades, rifles may be carried slung over the right shoulder with bayonets fixed.

#### SECTION IV

#### INSPECTIONS

■ 239. **GENERAL.**—The company is the basic unit for inspection. Battalion, regimental, and higher commanders or inspecting officers should inspect each company in its own area, or have each company march to a designated place at a specified time for inspection. Under special conditions an entire battalion or regiment may be formed and inspected in one large formation.

■ 240. **COMPANY.**—*a. Formation.*—The company forms in line or in an inspection formation of column of platoons as described in paragraph 241. If transportation is to be included in the formation it forms in line 3 paces in rear or as directed. Drivers of motor vehicles remain with their vehicles. Drivers and mule leaders of animal transportation stay with their animals. Drivers or animal leaders lay out their equipment as directed. Transportation may be inspected separately from the foot elements as directed.

*b. Procedure.*—(1) The company being in column of platoons (par. 241) the company commander commands: **PREPARE FOR INSPECTION**. At this command, platoon leaders cause ranks to be opened. They then place themselves, facing to the front, 3 paces in advance of the right flank of their platoons.

(2) Ranks having been opened, the company commander commands: **REST** and returns saber. He then inspects the company. During the inspection, officers, noncommissioned officers, and guidon bearers not in ranks come to attention at **ORDER ARMS** as the inspecting officer approaches, and after being inspected resume the position of **REST**. The company commander may direct the second in command and/or the first sergeant to join him and take down notes as he inspects.

The company commander, commencing at the head of the column, then makes a minute inspection of the arms, equipment, dress, and appearance of the personnel of the company. As he approaches each platoon, its leader brings the platoon to attention and salutes. As soon as inspected, the platoon leader returns saber, places himself on the right of the company commander, and accompanies him throughout the inspection of the platoon.

(3) The inspection is made from right to left in front and from left to right in rear of each rank.

(4) Each man executes **INSPECTION ARMS** as the company commander or inspecting officer reaches his position.

(5) The company commander takes the rifle, grasping it with the right hand just above the lower band, the man dropping his hands. He inspects the rifle and, with the hand and rifle in the same position as in receiving it, hands it back to the man, who takes it with the left hand at the balance and executes **ORDER ARMS**.

(6) Should the piece be inspected without handling, each man executes **ORDER ARMS** as soon as the company commander has passed to the next man.

(7) A man armed with the automatic rifle executes **INSPECTION ARMS** as the company commander reaches his position. The inspection completed, he pulls the trigger, replaces the magazine, and resumes the position of the soldier, the automatic rifle being slung.

(8) Enlisted men armed with the pistol execute **INSPECTION PISTOL**. When the company commander has passed, they execute **RETURN PISTOL**.

(9) Upon completion of the inspection of each platoon, its leader takes his post, faces down the line, and commands: 1. **CLOSE RANKS**, 2. **MARCH**, and adds **REST** after ranks have been closed. He then takes his post in front of the center of the platoon.

(10) The company commander may direct the platoon leaders to make the detailed inspection of arms or other equipment of the men of their platoons.

■ 241. **PERSONAL FIELD EQUIPMENT WHILE IN RANKS.**—The company forms in column of platoons (with each platoon in line) by forming extended mass formation to the right at 24 paces (par. 156 and fig. 38) and then executing **LEFT FACE**.

The company commander, after the inspection of arms has been completed in a platoon, causes that platoon to take interval and prepare for inspection of equipment. Intervals having been taken, the platoon leader commands: 1. UNSLING EQUIPMENT, 2. DISPLAY EQUIPMENT.

*a.* At the command UNSLING EQUIPMENT, each man draws his bayonet and with his left hand thrusts it into the ground, ring to the front, the bayonet outside of and against his left heel near the instep to mark the line for the rear edge of equipment when displayed. Men not armed with the rifle mark the place with the left heel. Each man then lays his rifle on the ground, muzzle to the front, barrel to the left, butt near the toe of his right foot, unslings his equipment and places it on the ground at his feet, haversack to the front, the pack 1 foot in front of his toes.

*b.* At the command DISPLAY EQUIPMENT, packs are opened and equipment displayed as prescribed in section IV, FM [21-15. Equipment is displayed in the interval to the left of each man. When equipment is displayed, each man resumes his original position in ranks.

*c.* The company commander then passes along the ranks as before, inspects the equipment, and directs the platoon leader to have packs rolled and the platoon assembled. The platoon leader then commands: ROLL PACKS.

*d.* Each man assembles his equipment and, leaving the equipment in its position on the ground at his feet, resumes the position of ATTENTION.

*e.* All equipment being assembled, the platoon leader commands: SLING EQUIPMENT.

*f.* Packs are slung and belts fastened and rifles taken.

*g.* The platoon leader then causes the platoon to assemble. The inspection is completed as already explained.

*h.* In units which have special combat equipment such as machine guns, mortars, signal or command post equipment, the company commander, after packs have been opened (or after the individual inspection has been completed), directs LAY OUT MACHINE-GUN (MORTAR OR OTHER) EQUIPMENT FOR INSPECTION. Gun squads under the direction of their leaders break ranks and lay out their weapons and accessories for inspection as prescribed in the gun drill for the weapon. Headquarters personnel lay out the fire-control, communication, or other combat equipment. The gun or equipment is

laid out in rear of its vehicle. If no transportation other than that drawn by hand is present, the equipment is displayed 3 paces from the flank of each squad on the side from which interval was taken. The rear of the equipment is placed on line with the rear edge of the individual field equipment.

■ 242. BATTALION.—*a.* The battalion is formed in column of companies, each company being formed as prescribed for the company. Any other convenient formation may be used. Before the inspection, the battalion commander indicates whether heavy weapons and special equipment are to be laid out for inspection or left on their transportation.

*b.* The headquarters, rifle, and weapons units are prepared and inspected in the manner prescribed for the company.

*c.* The battalion being in column of platoons, with all personnel dismounted, the battalion commander commands: **PREPARE FOR INSPECTION**. At this command each company and the band, if present, are prepared for inspection. Buglers rejoin their companies. The color bearer and the color guard proceed to the head of the column and take position 3 paces in rear of the staff.

*d.* The battalion commander then commands: **REST**, returns saber, and inspects his staff and the color guard. When the battalion commander approaches the staff, the officers, without command, come to attention at **ORDER SABER**. When they have been inspected, they return saber and accompany the battalion commander. As the battalion commander approaches the color guard, the color bearer commands: **1. COLOR GUARD, 2. ATTENTION**. The color guard may be dismissed as soon as inspected.

*e.* The battalion commander commencing at the head of the column makes an inspection of the arms, accouterments, dress, and appearance of the personnel of the band and of the several companies.

*f.* When the inspection of the band has been completed, it may be dismissed or it may take position at the rear of the column and play during the inspection.

*g.* As the battalion commander approaches each company, its commander faces toward it and commands: **1. COMPANY, 2. ATTENTION**, faces to the front, and salutes. As soon as he has been inspected, the company commander faces about

and commands: **REST**, returns saber, and accompanies the battalion commander. The inspection proceeds as prescribed for company inspection.

*h.* The battalion commander may direct the company commanders to make the detailed inspection of the arms or other equipment of their companies. He may require officers of his staff to assist in the inspection, especially by checking equipment.

*i.* When a company has been inspected, the battalion commander directs that it be dismissed or otherwise occupied.

*j.* When desired, the battalion commander may cause companies not under inspection to stack arms, fall out, and resume their places in time to be inspected.

*k.* If the inspecting officer is an officer other than the battalion commander, the latter prepares the battalion for inspection as prescribed in the preceding paragraphs. Upon the approach of the inspecting officer, the battalion commander brings the battalion to attention, faces to the front, and salutes. The inspecting officer inspects the battalion commander who then commands: **REST**, returns saber, and accompanies the inspecting officer. The inspection then proceeds as previously prescribed.

## SECTION V

### FUNERALS

■ 243. **GENERAL.**—*a.* Military funerals are divided into three classes as follows:

(1) With chapel service, followed by march to the grave (or place of local disposition), with the prescribed escort.

(2) Without chapel service, but with funeral procession forming at the entrance to the cemetery or at a point within a reasonable marching distance therefrom.

(3) With graveside service only.

*b.* A full military funeral normally consists of the following elements:

(1) Band.

(2) Escort appropriate to the grade of the deceased, including firing party and bugler (AR 600-30).

(3) Colors.

(4) Clergy.

(5) Caisson and casket bearers.

(6) Caparisoned horse (if the deceased was mounted).

(7) Honorary pallbearers.

c. The services of an Army chaplain will be provided unless otherwise requested by the family of the deceased or its representative. A civilian clergyman may be substituted for or act in conjunction with the Army chaplain. The desires of the family are paramount and will be given the fullest consideration as to the selection of elements involved, but the funeral will be conducted in accordance with these regulations.

d. The commanding officer or his representative will assist in making funeral arrangements and will supervise the conduct of the funeral.

e. The selection of honorary pallbearers, if they are desired, will be made by the family of the deceased, or its representatives, otherwise by the commanding officer.

f. At a military funeral, all persons in the military service in uniform or in civilian clothes, attending in their individual capacity, will stand at attention uncovered and hold the headdress over the left breast at any time when the casket is being moved by the casket bearers and during services at the grave, including the firing of volleys and the sounding of *Taps*. During the prayers, they will also bow their heads. In cold or inclement weather, they will remain covered and execute the hand salute at any time when the casket is being moved by the casket bearers and during the firing of volleys and sounding of *Taps*.

g. Whenever arms are presented at a military funeral of a person entitled to personal honors, the prescribed ruffles and flourishes will be sounded, followed immediately by the *National Anthem* (or *To the Colors* if only field music is present), or the march prescribed for the grade of the deceased, *except* where arms are presented at the close of the benediction at the grave.

h. The word "chapel" as used herein is interpreted to include the church, home, or other place where services are held, exclusive of the service at the grave.

i. The word "casket" is interpreted to include the receptacle containing the cremated remains of the deceased.

■ 244. WITH CHAPEL SERVICE.—a. Prior to the beginning of the service, the funeral escort is formed in line opposite and

facing the chapel, the band on the flank toward which it is to march.

*b.* Members of the immediate family, relatives, and friends of the deceased will be requested to enter the chapel and be seated before the casket is taken in. Members of the immediate family and relatives should occupy front seats on the right of the chapel.

*c.* The conveyance bearing the remains to the chapel should arrive in front of the chapel a few moments before the time set for the chapel service. When all is in readiness to move the casket into the chapel, the commander of the escort will bring the escort to **ATTENTION** and command: **1. PRESENT, 2. ARMS.** At the command **ARMS**, the band plays an appropriate air; the casket is removed from the conveyance by the casket bearers and carried between the ranks of honorary pallbearers, if present, into the chapel. When the casket has been carried into the chapel, the band ceases playing. The escort is then brought to the **ORDER** and may be permitted to stand at ease.

*d.* If honorary pallbearers are present, they will be formed in two ranks (each facing the other) forming an aisle from the conveyance to the entrance of the chapel. At the first note of the music and while the casket is being borne between ranks of honorary pallbearers, they will stand at **ATTENTION**, uncovered, and hold the headdress over the left breast. In cold or inclement weather, they will remain covered and will execute the **HAND SALUTE**. They will then follow the casket in column of twos and occupy pews to the left front.

*e.* When the casket has been placed upon the church truck, the casket bearers will form behind the honorary pallbearers and be seated behind them to the left front of the chapel. If there are no honorary pallbearers, the casket bearers will follow the casket in a column of twos and be seated as indicated above. Upon completion of the chapel service, the casket bearers will follow the honorary pallbearers or, if none is present, the chaplain, to the entrance of the chapel.

*f.* Upon completion of the chapel service, the honorary pallbearers will follow the chaplain in column of twos as the casket is moved to the entrance of the chapel. They will again form an aisle from the entrance of the chapel to the caisson or hearse and proceed as prescribed in *d* above. When the casket has been placed on the caisson they will, if march-

ing, form column of files on each side of the caisson, the leading member of each column opposite the front wheels of the caisson. If riding, they will enter their conveyances at this time.

*g.* The casket will be moved to the entrance immediately behind the honorary pallbearers and casket bearers followed by the family group. As soon as the honorary pallbearers have taken their positions (*f* above), casket bearers will carry the casket to the caisson and form in column of twos behind it. The family group will remain at the chapel entrance until the honorary pallbearers have broken ranks to enter their conveyances or have taken their positions at the caisson. The family group will then be conducted to their conveyances.

*h.* The funeral escort and band will follow the procedure prescribed in *c* above when the casket appears at the entrance of the chapel at the conclusion of the service. The band will cease playing when the casket has been secured to the caisson.

*i.* The procession is then formed in the following order:

- (1) Band.
- (2) Escort, including colors, firing party, and bugler.
- (3) Clergy.
- (4) Caisson and honorary pallbearers, if walking.
- (5) Casket bearers.
- (6) Caparisoned horse, if the deceased was mounted.
- (7) Honorary pallbearers, if riding in cars.
- (8) Family.
- (9) Patriotic or fraternal organizations.
- (10) Friends.

*j.* When the procession has been formed, the band and the escort are put in march by the commander of the escort. Elements in rear conform. The procession marches slowly to solemn music.

*k.* As the procession approaches the grave, marching elements march directly to positions previously determined. The band and military escort will be formed in line facing the grave, other marching elements being placed as near as practicable to the grave. The firing party will be so placed that it will not fire directly over the mourners.

*l.* As soon as the caisson is halted, honorary pallbearers will be formed in two ranks, each facing the other, extending



from the caisson toward the grave, with sufficient distance between ranks to permit passage of the casket. The casket bearers will remove the casket from the caisson, bear it between the lines of honorary pallbearers to the grave, and place the casket on the lowering device. They will remain in place facing the casket. They will raise the flag from the casket and hold it in a horizontal position, waist high, until the conclusion of *Taps*. The flag is then folded as prescribed in Army Regulations, care being taken that it does not touch the ground. It is then handed to the superintendent of the cemetery or his representative for disposition in accordance with Army Regulations. As soon as the casket, preceded by the chaplain and cemetery representative (or funeral director), has passed between the honorary pallbearers, they will face toward the grave and follow the casket in column of twos, followed by the family and friends. Upon arrival at the grave they will be formed in line in an appropriate position, facing the grave. When the grave is too near the road to permit the above formation, they will be directed to take their position at the grave prior to removal of the casket from the caisson. Upon the removal of the casket from the caisson, [they will uncover and remain uncovered until the conclusion [of *Taps*. In cold or inclement weather, they will remain [covered but will render the hand salute while the casket is being borne between their ranks and will again salute during the firing of musketry and the sounding of *Taps*.

*m.* As the casket bearers remove the casket from the caisson, the commander of the escort commands: 1. **PRESENT**, 2. **ARMS**. At the command **ARMS**, the band plays an appropriate air. When the casket has been placed over the grave the escort is brought to the order and the band ceases playing. The commander of the escort then commands: 1. **PARADE**, 2. **REST**. The escort executes **PARADE REST** with officers and men inclining their heads.

*n.* When the escort has been brought to **PARADE REST**, the chaplain conducts the graveside service. At the conclusion of the benediction, he will move two steps to the side or rear.

*o.* When the service has been completed, the commander causes the escort to resume attention. He then commands: 1. **ESCORT, LESS FIRING PARTY**, 2. **PRESENT**, 3. **ARMS**, 4. **FIRING PARTY**, 5. **FIRE THREE VOLLEYS**. The firing party then fires three volleys of blank cartridges, assumes the position of

READY, and remains in this position until the conclusion of *Taps*. At the command ARMS the bugler takes position at the head of the grave and sounds *Taps* immediately following the last volley.

*p.* At the conclusion of *Taps*, rifles of the firing party will be locked. The entire escort is then brought to the order. The band and escort are put in march in quick time by the commander of the escort. Other elements conform. The band will not play during the march from the grave. At the first halt, the rifles of the firing party are unloaded and inspected.

*q.* When the distance to the place of interment is considerable, the escort, after leaving the chapel, may march at ease in quick time until brought to attention in the vicinity of the grave. The band does not play while the escort is marching at ease. The field music may alternate with the band in playing.

■ 245. WITHOUT CHAPEL SERVICE BUT WITH PROCESSION AND GRAVESIDE SERVICE.—*a.* When the escort for a military funeral forms at or near the entrance to the cemetery, the officer in charge will supervise the transfer of the casket from the hearse to the caisson.

*b.* If honorary pallbearers are present, they will be formed in single line facing the caisson, the leading honorary pallbearers opposite the front wheel and on the side opposite to that on which the hearse is to be halted. If more than twelve are present they will form in double rank.

*c.* While the casket is being transferred from the hearse to the caisson, the escort is brought to PRESENT ARMS and the band plays an appropriate air. The honorary pallbearers uncover or salute as outlined in paragraph 244*d*. During the transfer of the casket, the family and friends remain in their conveyances.

*d.* The funeral procession is then formed and proceeds as prescribed in paragraph 244*j* to *q*, inclusive.

■ 246. GRAVESIDE SERVICE.—*a.* For this type of funeral all elements of a full military funeral, except the caisson and caparisoned horse, may be present and used as outlined in paragraph 244*l* to *q*, inclusive. However, if troops are not

conveniently available or the family desires to eliminate other elements, the following will suffice:

- (1) Clergy.
- (2) Casket bearers.
- (3) Firing party.
- (4) Bugler.

*b.* All military elements participating in a graveside service will be in position prior to the arrival of the remains.

■ 247. CREMATED REMAINS.—*a.* (1) In cases where the remains are cremated and the ashes interred with military honors, the provisions of paragraphs 244, 245, and 246 with necessary modifications will govern.

(2) For all phases of the funeral where the cremated remains are carried by hand, one enlisted man will be detailed to carry the receptacle containing the ashes. Four enlisted men will also be detailed as flag bearers. When the receptacle containing the ashes is carried from the conveyance into the chapel, from the chapel to the conveyance or conveyance to the grave, the flag bearers will follow the receptacle, the flag being folded as prescribed in paragraph 2*g*, AR 260-10, and carried by the leading flag bearer on the right.

(3) When the receptacle has been placed on the stand before the chancel of the chapel or when placed in the conveyance, the flag will be folded and placed beside the receptacle. If the caisson is equipped with a casket container for the receptacle, the open flag will be laid upon the container as prescribed for a casket, otherwise the flag will be carried, folded as prescribed, by the active flag bearers.

(4) When no hearse or caisson is used, suitable transportation will be provided for the receptacle bearer and the flag bearers.

*b.* In cases where the remains are conducted to a crematory and the ashes are to be interred with military honors at a later time, the ceremony will consist only of the escort to the crematory. Arms will be presented as the remains are borne into the crematory. The firing of volleys and sounding of *Taps* are omitted. In case the funeral ceremony is held at the crematory and no further military honors are anticipated, the volleys may be fired and *Taps* sounded at

the discretion of the commanding officer and dependent upon local conditions.

■ 248. CEREMONY PRIOR TO SHIPMENT OF REMAINS.—In cases where the remains of a deceased officer or soldier are moved to a railway station or other point for shipment to a distant place for interment or final disposition, funeral services, modified as necessary, may be carried out essentially as prescribed in paragraphs 244, 245, and 246. If no further military honors are anticipated at the place of interment or final disposition, the volleys of musketry may be fired and *Taps* sounded at the discretion of the commanding officer and dependent upon local conditions. If military honors are anticipated at the place of final disposition, the firing of volleys and sounding of *Taps* will be omitted.

■ 249. CANNON SALUTE.—*a.* When the funeral of an officer on the active or retired list who was entitled to a salute takes place at or near a military post, minute guns will be fired while the remains are being borne to the place of interment (or place of local disposition). The first gun will be fired immediately after the procession is put in motion.

*b.* Immediately after the remains have been lowered into the grave (upon completion of the benediction) a salute corresponding to the grade of the deceased (as prescribed in Army Regulations) will be fired, followed by three salvos of artillery, guns firing simultaneously, or three volleys of musketry.

■ 250. PARTICIPATION OF AVIATION.—When aviation participates in a military funeral, the participation will be so timed that airplanes will appear over the procession while the remains are being borne to the grave.

■ 251. PARTICIPATION OF FRATERNAL OR PATRIOTIC ORGANIZATIONS.—*a.* At the request of the immediate family of the deceased or its representative, fraternal or military organizations of which the deceased was a member may be permitted to take part in the funeral services.

*b.* If the ritual is military or semimilitary in nature, the rites will begin immediately upon the conclusion of the Army religious service. If the ritual contains the firing of three volleys of musketry and the sounding of *Taps*, the military

firing party and bugler may be used. This sounding of *Taps* will conclude the funeral services.

c. Nonmilitary rituals by fraternal organizations will be held at the conclusion of *Taps*. The military escort will be marched away from the site of the grave promptly and quietly at the termination of the military ceremonies.

■ 252. DUTIES OF CHAPLAIN.—The chaplain will take position in front of the chapel prior to the arrival of the remains. He will precede the casket when it is borne into the chapel and again while the casket is borne from the chapel to the caisson or hearse. While the remains are being placed on the caisson or in the hearse, he will stand uncovered at the rear and to the side facing the caisson or hearse. When the casket has been secured, he will take his position in front of the caisson or hearse. In the event that the chaplain is wearing vestments, he may, at his discretion, proceed directly from the chancel to the sacristy at the conclusion of the service and devest, joining the procession just prior to its movement from the chapel. When the procession is formed at the entrance to the cemetery or other point and the chapel service is omitted, he will take a similar position near the caisson while the remains are being transferred from the hearse to the caisson. If riding, his conveyance will be placed in position in front of the caisson or hearse. In cold or inclement weather, the chaplain may remain covered except when reading such parts of the service as require that he be uncovered.

■ 253. PRELIMINARY ARRANGEMENTS.—The officer detailed in charge of a military funeral, accompanied by the commander of the escort and the superintendent of the cemetery or his representative, will visit the places involved and make careful arrangements prior to the time set for the funeral. Positions at the grave to be occupied by various elements of the funeral, arrangements for traffic control, etc., will be definitely determined.

■ 254. FLORAL TRIBUTES.—a. In the absence of a funeral director, the officer in charge, assisted by the chaplain and such details as may be required, will cause all floral tributes to be properly arranged in the chapel and at the grave. He will call upon the commanding officer for necessary transportation for the prompt transfer of floral tributes from the

chapel to the grave. The conveyance bearing floral tributes will be loaded promptly at the conclusion of the chapel service and will precede the funeral procession, moving as rapidly as practicable to the site of the grave. The funeral procession will not move from the chapel until the conveyance carrying floral tributes has cleared the escort.

b. The officer in charge will be responsible that cards are removed and a record made giving a brief description of the floral piece pertaining to each card. The cards and record will be turned over to a member of the family of the deceased after completion of the funeral services.

## CHAPTER 10

### EXTENDED ORDER

	Paragraphs
SECTION I. General.....	255-256
II. Rifle squad.....	257-263
III. Automatic rifle squad.....	264-266
IV. Rifle platoon.....	267-281
V. Company.....	282
VI. Weapons squads, sections, and platoons.....	283-285

#### SECTION I

#### GENERAL

■ 255. GENERAL RULES.—a. The dispositions and movements given in this chapter are to provide for the orderly deployment of small units for battle and for movement under battle-field conditions. They are not intended as disciplinary drills or drills of precision, and for practice are executed at ease. They should be held upon ground affording concealment and cover. When such terrain is available or may be found within reasonable proximity to the garrison, only such preliminary training is given on flat or bare drill grounds as is necessary to teach the mechanism of deployment and to illustrate the different dispositions and movements.

¶b. Straight lines are avoided. The disposition and the distances and intervals given herein should be modified to meet the existing terrain, enemy fire, and space available. The usual distance or interval between individual men in extended order is 5 paces, which is generally indicated in the descriptions and figures which follow. These distances and intervals are variable and leaders, including squad leaders,

will order distribution, distances, and intervals suited to the circumstances and to the terrain.

*c.* The commander prescribes the distribution of his unit and may initially prescribe the dispositions of subordinate units. Thereafter during the advance, the subordinate commanders may vary the dispositions in their units in order to make the best use of ground and cover.

*d.* Platoon, section, and squad leaders deploy, assemble, and maneuver their units as far as practicable by arm signals. Whistle signals are sparingly used. In general, use of the whistle is limited to occasions when it is impossible to attract attention by other means. The habitual use of the whistle as a preliminary to a command is prohibited. (For signals see ch. 11.)

*e.* A deployed unit advances, halts, moves to the flank or to the rear, passes from a walk to a run and the reverse on receiving the appropriate signals or commands. Changes in the direction of march are usually effected by the assignment of a new march direction to the base squad. Movements may be interrupted by the signal or command HALT or DOWN. On halting, a deployed line faces to the front (direction of the enemy). If halted by the command DOWN, the men take cover.

*f.* Deployment as skirmishers is made at a run. Other movements are made at a walk unless otherwise ordered.

■ 256. INDIVIDUAL INSTRUCTION.—The soldier is taught how to set the sight of his rifle, to fire, to lie down, to crawl, to make the best use of ground and cover, and the duties of a scout (FM 21-45) prior to or concurrently with the instruction in battlefield formations and movements.

*a. Set sight.*—The unit or group being in any firing formation, the commands are: RANGE, SIX HUNDRED or BATTLE SIGHT. The sight is set as ordered.

*b. Commence firing.*—(1) Being in any firing formation, the command is: COMMENCE FIRING. Each man, independently, aims carefully and deliberately at the aiming point or target, fires, reloads, and continues firing until ordered to cease firing.

(2) To increase (decrease) the rate of fire in progress, the instructor commands or signals: FASTER (SLOWER).

*c. Instructions for use of bayonet.*—(1) The bayonet is fixed at any time when so ordered.

(2) If marching, kneeling, or prone, the bayonet is fixed and unfixed in the most expeditious and convenient manner and the rifle returned to the original position.

*d. Being at halt, or moving.*—(1) To lie down, the command is: DOWN. All drop to the prone position flat on the belly.

[(2) When men are moving, they carry their rifles at port [or in other convenient manner.

## SECTION II

### RIFLE SQUAD

■ 257. DISTANCES AND INTERVALS BETWEEN MEN WHEN DEPLOYED.—Distances and intervals as indicated in figures are [variable. The squad leader may direct lesser or greater intervals and distances and individual skirmishers vary their position so as to take full advantage of cover or concealment. Close grouping in the open is avoided, but two or three men [may group together to take advantage of suitable cover or concealment.

■ 258. DISPOSITIONS.—Dispositions of the rifle squad are—  
 Squad column.  
 As skirmishers.  
 As skirmishers right (or left).  
 Squad wedge.

*a. Squad column* (fig. 70).—At the command given when the squad is disposed in any manner, its members form in an irregular column behind the squad leader. The disposition of individuals in the column will be adapted to the terrain and circumstances and may vary from a widely spaced and staggered column suitable for crossing very open country to a column of files closed up behind the leader.

*b. As skirmishers* (fig. 72).—At the signal or command, usually given from squad column but permissible from any disposition, the squad deploys in an irregular line as shown in figure 72. Even numbers go to the right, odd numbers to the left. The squad leader is in front of his squad when it is advancing. When it halts to fire, he drops back behind the line to a position from which he can control his squad and



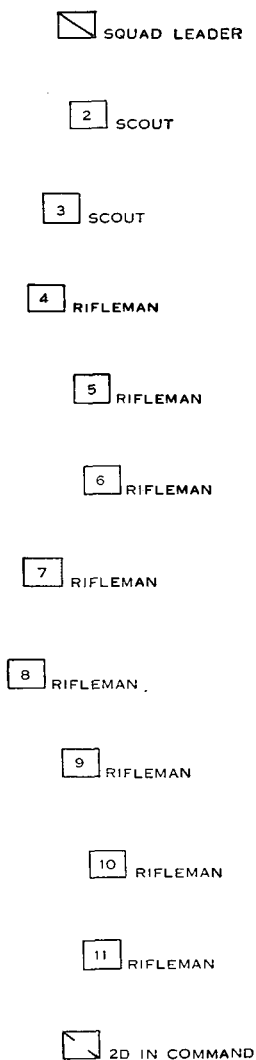

FIGURE 70.—Squad column (closed) (distance between men approximately 5 paces).

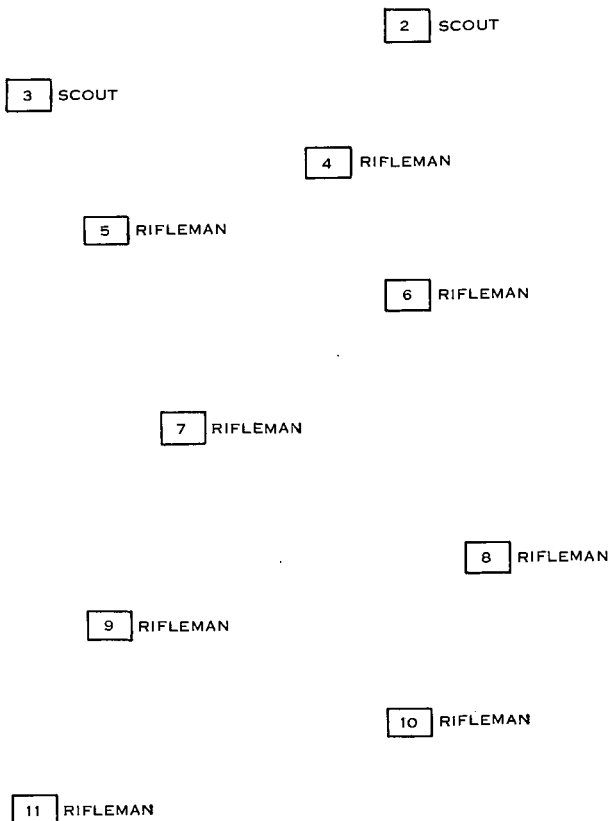

FIGURE 71.—Squad column (opened) (distance between men approximately 5 paces; width approximately 20 paces).



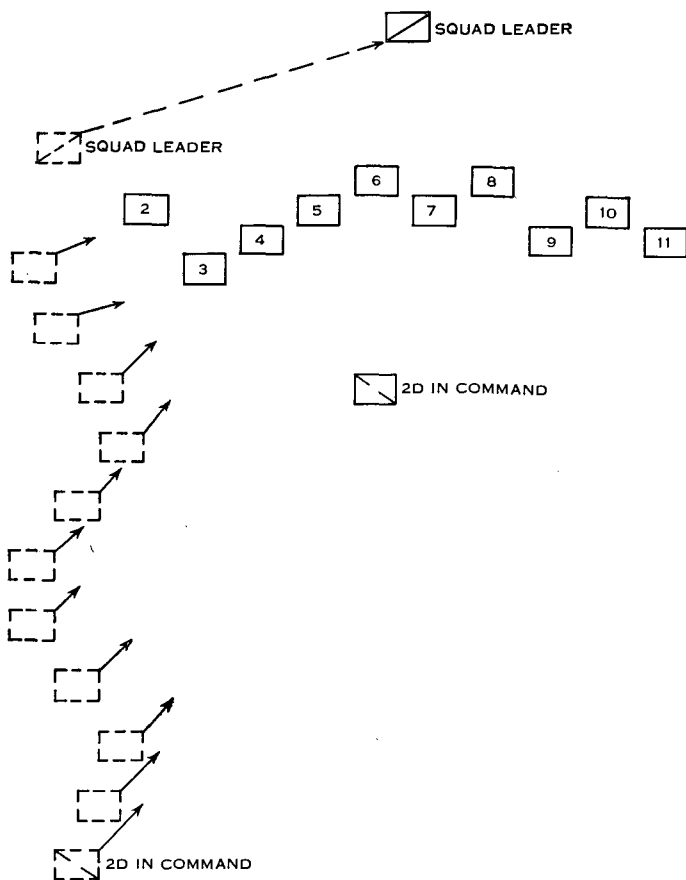

FIGURE 73.—Skirmishers right (or left) (interval between men [approximately 5 paces]).

observe to the front. If there is an automatic rifleman in the squad, he joins the squad leader and awaits orders for any special fire mission.

c. *As skirmishers right (or left)* (fig. 73).—At the signal or command, usually given from squad column but permissible from any disposition, the squad deploys to the right as shown

in figure 73. The squad leader is in front of his squad when it is advancing. When it halts to fire he drops back behind the line to a point from which he can control his squad and observe to the front. If there is an automatic rifleman in the squad, he joins the squad leader and waits for orders for any special fire mission.

*d. Squad wedge* (fig. 74).—At the command, usually given from squad column but permissible from any disposition, the men dispose themselves in an irregular wedge behind the squad leader as shown in figure 74. If there is an automatic rifleman in the squad, he takes position in the center of the wedge unless otherwise directed.

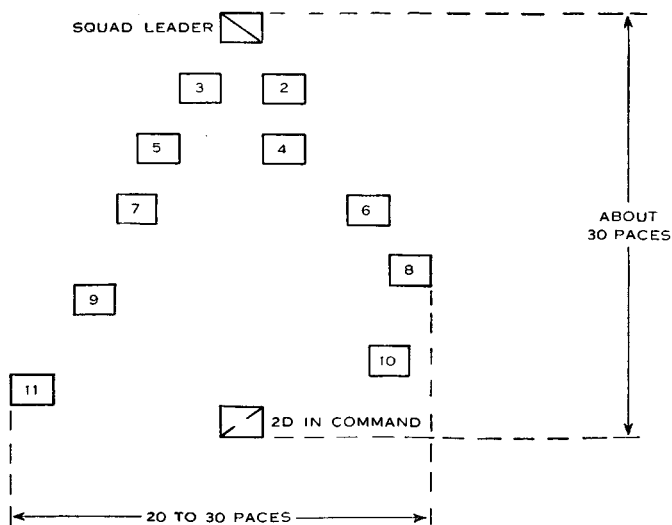

FIGURE 74.—Squad wedge.

■ 259. **ADVANCE BY INDIVIDUALS.**—To advance by individuals the squad leader indicates the objective, the man or men who are to start the movement, and commands or signals: **FORWARD**. Each man chooses the time and method for his own advance so as to take advantage of existing cover and to avoid enemy fire. If the objective is not indicated, the leading men select the next cover or firing position. They do not advance

so far as to lose contact with their squad leader. The squad leader follows after the first three or four men, directing their advance if necessary. The second in command insures that the others follow.

■ 260. RUSHES.—*a.* When it is desired to move the entire squad simultaneously from cover to cover, the leader commands: 1. PREPARE TO RUSH, 2. FOLLOW ME. At the command FOLLOW ME, all men spring forward following the example of the leader. If necessary for safety, the squad leader may first command: CEASE FIRING. The rush terminates when the squad has closed with the enemy or when the leader commands or signals DOWN.

*b.* The rush may be executed by the entire squad as a unit as explained above, or by any fraction or individuals thereof. In the latter case the leader designates the part of the squad or the individuals who are to make the rush and the next position.

■ 261. FOLLOW SQUAD LEADER.—The leader places himself in front of his unit and commands: FOLLOW ME. The other members of the squad follow him, retaining the approximate disposition of the unit at the time when the command was given.

■ 262. ASSEMBLE SQUAD.—At the signal or command ASSEMBLE, the squad assembles on the leader and in column with 40 inches distance between men.

■ 263. SCOUTS.—*a.* In each rifle squad, Nos. 2 and 3 are designated as scouts and receive special training (FM 21-45 and FM 7-5).

*b.* When advancing in the presence of the enemy, the squad (platoon or company) is preceded by its scouts who seek out the enemy and prevent surprise. Scouts precede the squad at such distance that it will not be subjected to surprise small-arms fire.

*c.* To cause the scouts to precede their unit, the command is: SCOUTS OUT. The scouts move forward in front of their units and maintain contact with the unit from which sent out.

## [SECTION III

## [AUTOMATIC RIFLE SQUAD

264. DISTANCES AND INTERVALS BETWEEN MEN WHEN DEPLOYED.—The intervals and distances indicated in figures 75, 76, and 79 are variable but conform in general to those of the rifle squad. The organization of the automatic rifle squad lends itself readily to employment as a unit or as two separate gun teams.

265. DISPOSITIONS.—*a.* Dispositions of the automatic rifle squad are—

[Squad column (figs. 75 and 76).

[As skirmishers (fig. 77).

[As skirmishers right (or left) (fig. 78).

[Squad wedge (fig. 79).

*b.* The commands and dispositions of the automatic rifle squad in general are as prescribed for the rifle squad except that the automatic rifle squad forms by teams as indicated.

266. METHODS OF ADVANCING AND ASSEMBLY.—As prescribed for the rifle squad.

## [SECTION IV

## RIFLE PLATOON

267. DIRECTION OF DEPLOYMENT.—The platoon is trained to deploy in any direction in silence and without confusion. The direction is indicated by the leader pointing or moving in the desired direction.

268. DIRECTION OF ADVANCE.—The direction of advance may be indicated by the leader pointing or moving in that direction; by designating prominent terrain features such as building or lone tree; by magnetic azimuth; by indicating to the leader of the base unit the route to be followed; or by any combination of the above. Where an advance is to take place in an assigned direction for a considerable time, both a distant direction point and a magnetic azimuth should be designated.

269. BASE SQUAD.—*a.* The center rifle squad is the base squad, with the following exceptions:



SQUAD LEADER



AUTOMATIC RIFLEMAN

ASSISTANT  
AUTOMATIC RIFLEMAN

CARRIER



AUTOMATIC RIFLEMAN

ASSISTANT  
AUTOMATIC RIFLEMAN

CARRIER

SECOND IN  
COMMAND

FIGURE 75.—Automatic rifle squad column (closed) (distance between men approximately 5 paces).





**SQUAD LEADER**



**AUTOMATIC  
RIFLEMEN**



**ASSISTANT AUTOMATIC RIFLEMEN**



**CARRIERS**



**SECOND IN COMMAND**

**FIGURE 76.**—Automatic rifle squad column (opened) (distance between men approximately 5 paces; width approximately 20 paces).

(1) When in platoon column, the leading squad is the base squad.

(2) When deployed in squad column or as skirmishers [with one rifle squad back, the right flank rifle squad is the base squad unless otherwise indicated.

b. The other squads of the platoon maintain direction and relative position by regulating on the base squad.



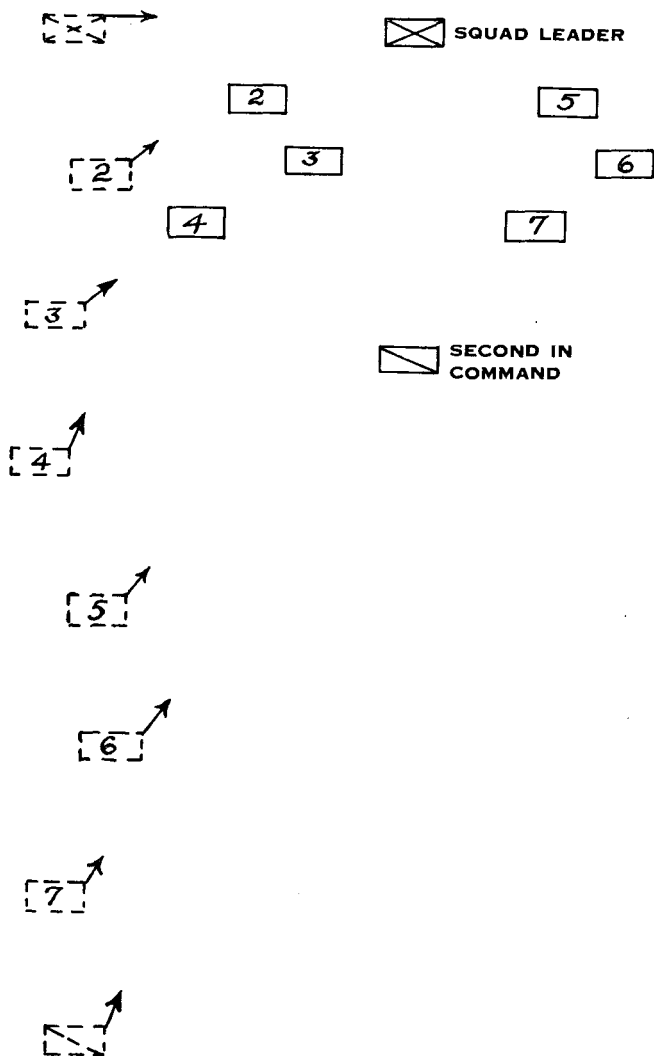
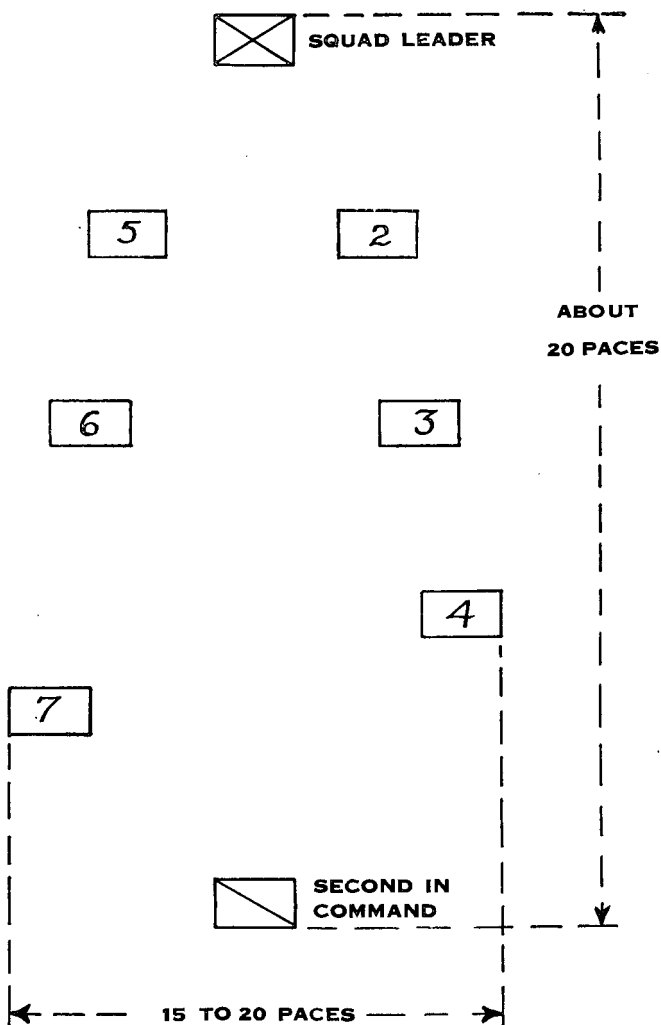

FIGURE 78.—Automatic rifle squad as skirmishers right (left).



[FIGURE 79.—Automatic rifle squad wedge.]

■ 270. DISPOSITIONS.—*a.* The platoon may use any of the following dispositions:

- (1) Column of threes.
- (2) Column of twos (par. 146).
- (3) Platoon column (fig. 80).
- (4) Line of squads (fig. 80).

[(5) One rifle squad forward, two rifle squads back, automatic rifle squad in rear (fig. 80).

[(6) Two rifle squads forward, center rifle squad back, automatic rifle squad in rear (fig. 80).

*b.* When the platoon is deployed, each squad may be in squad column, squad wedge, or as skirmishers.

■ 271. FRONTAGE.—The platoon deploys with sufficient intervals between squads to permit minor maneuvers of squads. Unless otherwise directed, squad columns or squads disposed as a wedge keep about 50 yards apart. When deployed as skirmishers, adjacent squads deploy with about 20 yards interval between squads unless otherwise directed.

■ 272. POSTS OF PLATOON LEADER AND SECOND IN COMMAND.—The platoon leader and the second in command are not restricted to fixed posts. When moving forward, the platoon leader usually precedes his unit, the second in command follows in rear and assists in control. During forward or flank movements, the platoon leader is on the side of the platoon toward the enemy. During movements to the rear, he is on the side away from the enemy. When the platoon is halted in a firing position, he is in rear of his platoon. When otherwise halted, he is in front of his platoon. The second in command takes positions from which he can best assist the platoon leader in controlling the platoon.

■ 273. PLATOON COLUMN.—At the signal or command, the [base squad moves out in squad column, followed in order as [prescribed in paragraph 146 or in any other order as directed by the platoon leader. Usually the automatic rifle [squad follows in rear.

■ 274. DEPLOY INTO SQUAD COLUMNS.—*a.* *With squad columns in line.*—The command is: SQUAD COLUMNS. The base or leading squad moves in squad column to the front or in the direction indicated by the platoon leader. The other two [rifle squads move in squad column to positions approxi-

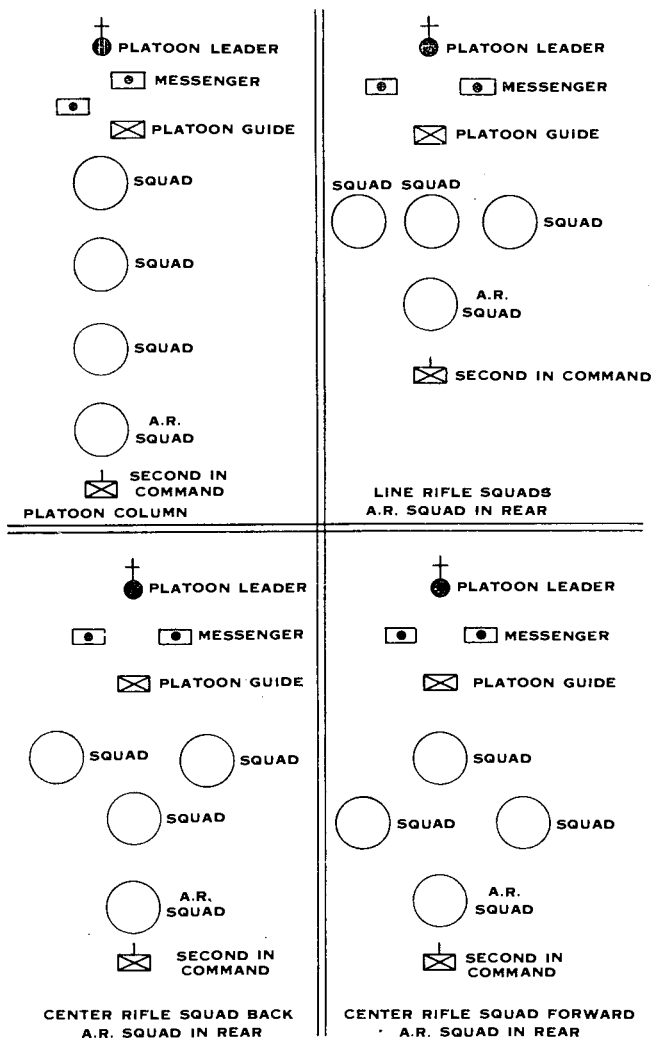

DISPOSITIONS FOR THE PLATOON DISTANCES AND INTERVALS VARIABLE

FIGURE 80.—Disposition for the platoon.

imately 50 paces to the right and left of the base or leading squad. The automatic rifle squad follows in rear of the base or leading squad at about 50 paces. Leaders of the flank rifle squads guide on the base squad but make no effort to maintain exact alinement.

**b. In squad columns with one rifle squad forward.**—At the command SQUAD COLUMNS, the base (or designated) rifle squad moves in squad column to the front or in the direction indicated by the platoon leader, the other two rifle squads move in squad column to the right and left until about 50 paces apart and follow the base or leading squad at about 50 paces. The automatic rifle squad moves in squad column to a position in rear of the base squad and follows the two flank squads at about 50 paces. If the base squad is halted by the platoon leader, the other two rifle and the automatic rifle squads move to the rear if necessary to gain their positions (fig. 80).

**c. In squad columns with one rifle squad back.**—At the command SQUAD COLUMNS, CENTER (OR DESIGNATED) RIFLE SQUAD BACK, the other two rifle squads move in squad column to the right and left so as to march in the direction indicated by the platoon leader with about 50 paces interval. The center (or designated) rifle squad follows the leading squads in squad column at about 50 paces. The automatic rifle squad follows the center (or designated) rifle squad at about 50 paces. If the leading squads are halted by the platoon leader, the center (or designated) rifle squad and the automatic rifle squad move to the rear if necessary to gain their positions (fig. 80).

**d.** From column of threes or fours the center rifle squad is usually designated as the forward or rear squad. In other dispositions, the squad most conveniently located may be designated.

■ 275. DEPLOY PLATOON AS SKIRMISHERS.—**a.** The command is: AS SKIRMISHERS. The squads move out as indicated for squad columns (par. 274a) and deploy as skirmishers at the command of the squad leader as they reach their positions.

**b.** To deploy as skirmishers with one rifle squad forward (or back) the command is: AS SKIRMISHERS, BASE (or DESIGNATED) SQUAD FORWARD (or BACK), The

[squads move out as indicated in paragraph 274*b* or *c*, deploying as skirmishers as they reach their positions.

■ 276. **DEPLOY SQUADS AS SKIRMISHERS.**—The platoon being in squad columns, the platoon leader may deploy the squads as skirmishers by commanding: **AS SKIRMISHERS.** At this signal or command the squads deploy, retaining their relative positions within the platoon.

■ 277. **ASSEMBLE PLATOON.**—To assemble the platoon, the leader signals or commands: **ASSEMBLE,** and points to the place where the assembly is to be made. The platoon assembles in column of threes or fours.

■ 278. **ADVANCE PLATOON.**—*a.* The leader, assisted by the second in command, directs the advance of the platoon. To advance individual squads, the platoon leader signals **FORWARD** to the squad leaders concerned, leaving the method of advance to them, or he may go to the squad leaders concerned or assemble them and give them direct oral orders for their advance. He may send the order by his second in command or messenger.

*b.* To cause the entire platoon to rush, the leader commands: **FOLLOW ME,** and springs forward leading the platoon to the new position.

■ 279. **ANTI-AIRCRAFT DEPLOYMENT.**—*a.* Being in column of [threes, the automatic rifle squad in rear, at the command, [PLANE(S) FRONT (RIGHT, LEFT, OR REAR), the right squad moves to the right at top speed. The leading and rear men of the right squad go about 10 paces and the center man about 50 paces. Other men of the right squad go to such distances that when halted the squad forms a rough semicircle. The left squad moves to the left in like manner. The men of the center squad take interval between the right and left squads, odd-numbered men to the left and even-numbered men to the right. The automatic rifle squad deploys to the right and left of the road by teams (fig. 81).

*b.* In deployments against air attack, men upon halting assume the anti-aircraft firing position facing the approaching airplanes.

*c.* Being deployed to meet an air attack, if it is desired to continue the march without assembling on the road, squad columns are formed and the march continued off the road.



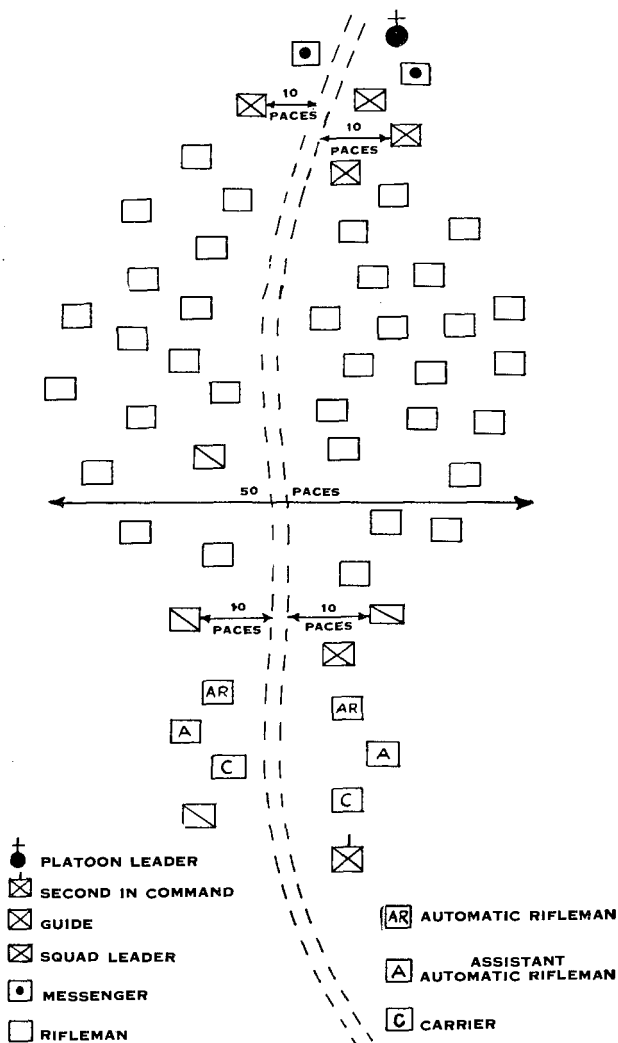

FIGURE 81.—Platoon antiaircraft deployment.

d. In a four-squad unit marching in column of fours, the same method is used. The two center squads deploy to the right and left.

e. In column of twos the same method is used, the right column deploying to the right and the left column deploying to the left.

■ 280. POSTS OF GUIDE AND OF MESSENGER.—The platoon guide and the messenger join the platoon leader on deployment.

■ 281. USE OF SCOUTS.—When contact is imminent the platoon leader sends out scouts from the leading squads. No more scout pairs than are necessary to cover the front of the platoon will be used.

## SECTION V

### COMPANY

■ 282. GENERAL.—The company does not execute extended order movements by any special signals or commands. The platoons are usually disposed and maneuver as directed by the company commander. Such directions are usually given in the form of oral combat orders. Commands analogous to those prescribed for the platoon may be used when appropriate.

## SECTION VI

### WEAPONS SQUADS, SECTIONS, AND PLATOONS

■ 283. SQUAD.—a. *General.*—Weapons squads represent teams serving a single weapon (machine gun, mortar, or antitank gun). Therefore the deployment of weapons squads is limited to taking up a dispersed formation to prevent casualties when moving. When firing, the crew is at the weapon. Carriers bearing ammunition operate between the ammunition vehicle and the weapon. The usual deployment for weapons squads is therefore an irregular column. When desired, a formation similar to that of adjacent units may be prescribed. Specific instructions for the organization, duties, and equipment of crews are given in drills for the particular weapon. Movements prescribed in this section are executed while at ease, and at a walk unless otherwise directed.

*b. Duties of squad leader.*—The squad is deployed and led by its leader. During movement, his usual position is at the head of his squad. It is his duty to watch his section leader for signals and to lead his squad in the assigned direction, controlling the movements of his men to insure the skillful use of ground and cover. When resuming the advance after a halt, he will make sure that all members of the squad have understood the order to move forward. In case of casualties, he will prescribe such redistribution of the loads of members of the squad as will insure the arrival at the next firing position of all equipment necessary for the immediate opening of fire. A man may be designated to man the anti-aircraft weapon on the weapons carrier if necessary.

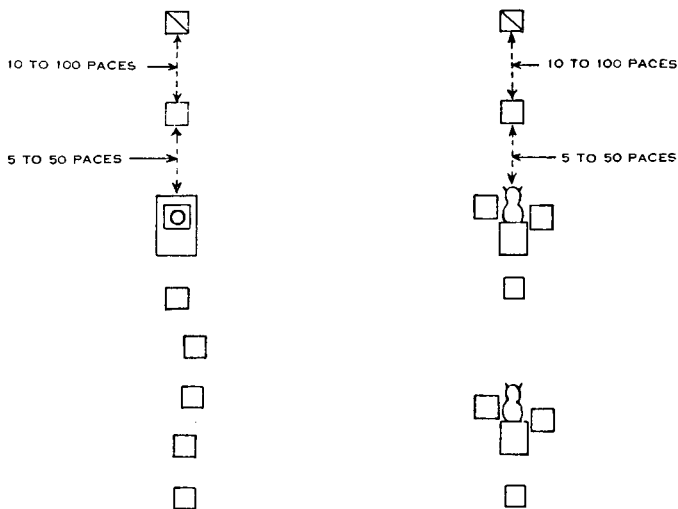

SQUAD WITH MOTOR TRUCK OR CARRIER. THE POSITION OF THE CARRIER AND THE NUMBERS ASSIGNED INDIVIDUALS WILL VARY TO FIT THE PARTICULAR WEAPON SQUAD.

SQUAD WITH ANIMAL DRAWN CARTS OR PACK ANIMALS

FIGURE 82.—Weapons squad with transportation in squad column.

*c. Squad column with transportation.*—At the command SQUAD COLUMN, the squad forms in a single file in rear of its transportation. The distance between men is 5 paces unless otherwise directed. This is varied to meet existing conditions.

*d. Squad column without transportation.*—(1) The squad leader directs: UNLOAD TRUCK (OFF CARTS or OFF PACKS). Each man takes the equipment as prescribed in the drill for the weapon and forms in numerical order in single file on the right of the vehicle unless otherwise directed.

(2) When equipment is removed, the squad leader directs: SQUAD COLUMN. The men form in an irregular column behind the squad leader.

(3) The driver of the vehicle (or mule leader) remains with his vehicle (or mule) and places it under any available cover or concealment.

*e. Maneuver squad.*—(1) The squad leader commands: FOLLOW ME. The squad follows its leader in squad column.

(2) If the weapon has been taken from the truck (or carts), the driver of the vehicle (or mule leader) places the transportation under cover.

*f. Halt squad.*—At the signal or command HALT, all men seek the nearest cover. The transportation takes advantage of any convenient concealment or cover. All watch the squad leader for further orders or signals.

*g. Load transportation.*—The squad leader calls or sends for the transportation, halting it under cover (if available) near the squad. At the command LOAD TRUCKS (ON CARTS or ON PACKS) the squad assembles at the transportation, loads its equipment and forms squad column as shown in figure 82.

■ 284. SECTION.—*a. Duties of section leader.*—The section is deployed and led by its leader. During movement he occupies no fixed position, but generally he will be in advance of his unit. When leading his section, he selects routes of advance and reconnoiters for gun positions and targets. When the section is halted in a firing position, he places himself where he can best control its fire, usually in rear of and between his weapons. When otherwise halted, he is usually in front of his section. He keeps in touch with the platoon leader at all times.

*b. Dispositions.*—The section may be disposed in line of squad columns or in section column as shown in figure 83.

(1) The commands for these dispositions are: **LINE OF SQUAD COLUMNS 50** (or other) **PACES**, or **SECTION COLUMN 20** (or other) **PACES**. Each squad leader leads his squad so as to take the disposition directed (fig. 82).

(2) To maneuver without transportation, the section leader first gives the necessary commands to unload transportation, and after it is unloaded gives the command for the disposition desired. The transportation takes cover or moves as directed.

*c. Assemble.*—To assemble the section, the section leader takes post at or designates the point at which the section is to assemble and commands or signals: **ASSEMBLE**. Each squad leader assembles his squad, moves it to the point of assembly, and forms as directed.

■ 285. **PLATOON.**—*a. Duties of platoon leader.*—The platoon leader does not remain in a fixed position with respect to his unit, but goes wherever his presence is required. During movement, he is generally on the side toward the enemy. When the platoon is in action, he occupies a position from which he can observe the effect of fire and from which he can control his sections. The platoon leader deploys the platoon and directs the advance of and assigns firing positions to his sections.

*b. Duties of platoon sergeant.*—The platoon sergeant is the second in command. He commands the platoon when the leader goes ahead on reconnaissance. When the platoon commander is within such distance of his unit as to be able to control its advance, the platoon sergeant follows in rear of the platoon during movement and insures its orderly advance.

*c. Duties of transport corporal.*—The transport corporal marches (or rides) at the rear of the pack animals, carts, or vehicles of the platoon and insures their orderly advance. After **OFF CARTS** (OR **OFF PACKS** OR **UNLOAD**) has been executed, he takes charge of the carts or vehicles and disposes of them in accordance with orders from the platoon leader. In case orders are not issued, the transport corporal takes the transportation to the nearest available cover.

*d. Duties of agent corporal.*—When the platoon is deployed, the messengers are formed as a group under command of the corporal agent. The corporal agent conducts this group

☒ SECTION LEADER

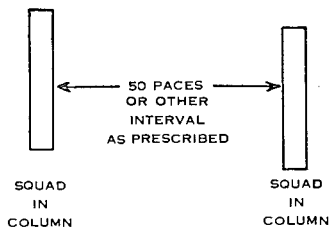

### LINE OF SQUADS

☒ SECTION LEADER

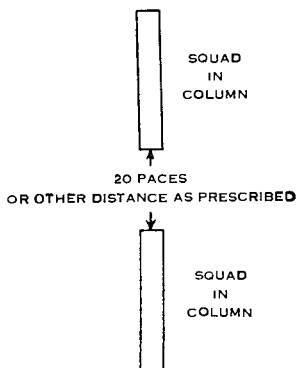

### SECTION COLUMN

FIGURE 83.—Dispositions for weapons section.

at the head of the platoon, unless otherwise directed, conforming to the disposition of its other elements.

*e. Dispositions.*—The platoon deploys in the same manner as the squad and section. The section may be disposed in platoon column, line of sections, or antiaircraft deployment. The dispositions, intervals, and distances will depend upon the requirements of the tactical situation, the nature of the ground, and the fire of the enemy. Each section leader disposes of his squad so as to make the maximum use of cover. The dispositions, intervals, and distances may be changed from time to time during the advance, both in the platoon and in the section. The antiaircraft disposition is generally similar to that given for the rifle platoon in paragraph 279.

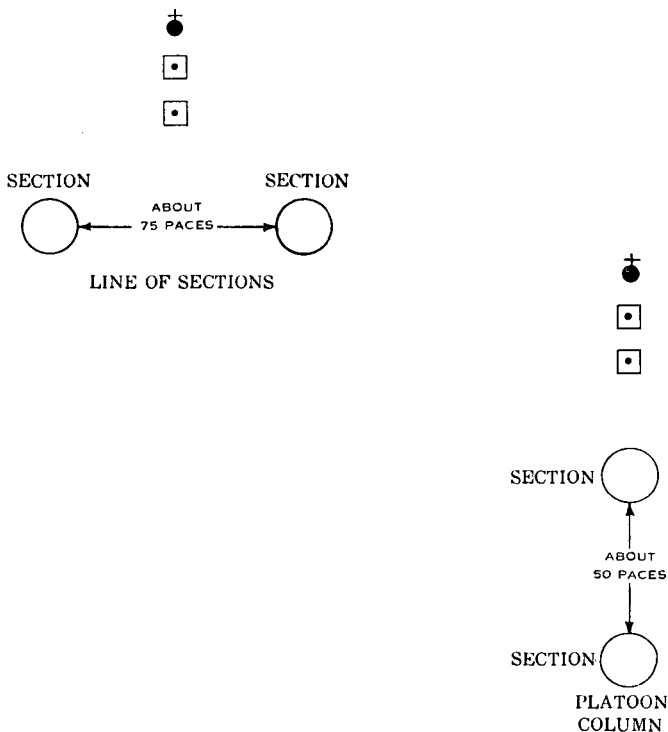

FIGURE 84.—Formations of weapons platoon.

Carts or motor vehicles clear the road and stop under available cover.

*f. Line of sections.*—At the signal or command, **LINE OF SECTIONS**, the leading or right section moves straight to the front or in the designated direction. The other section moves to the left and forward until the required interval has been gained and the section is on line with the base section. If no interval is announced, the platoon will deploy with 75 paces between sections.

*g. Platoon column.*—At the signal or command, **PLATOON COLUMN**, one section follows the other in column as indicated by the platoon leader.

*h. Assembly.*—To assemble the platoon from any disposition, the platoon leader takes post at or designates the point at which the platoon is to assemble and signals or commands: **ASSEMBLE**. At this signal or command, each section leader assembles his section and conducts it to the point of assembly. The platoon is then assembled in column of fours or as directed. The sections of a platoon can be assembled by the commands: 1. **BY SECTIONS**, 2. **ASSEMBLE**.

## CHAPTER 11

### SIGNALS

	Paragraphs
<b>SECTION I. General</b> .....	286-287
<b>II. Whistle signals</b> .....	288-291
<b>III. General arm and hand signals</b> .....	292-314
<b>IV. Additional arm and hand signals for weapons units</b> .....	315-323
<b>V. Arm and hand signals for motor vehicles</b> .....	324-326

#### SECTION I

#### GENERAL

■ 286. **PURPOSE.**—Signals are for the purpose of transmitting essential commands under conditions rendering verbal commands inadequate.

■ [287. **KINDS.**—Signals may be audible or visible as prescribed herein.

*a. Subordinate commanders repeat signals or give appropriate orders to their units whenever necessary to insure prompt and correct execution.*



**[b. Standard signal for use by ground troops to warn of air or mechanized danger.—**The following signals will be used by observers of all arms and services in transmitting warning of the approach or presence of hostile aircraft or mechanized vehicles:

**[**Three long blasts of a whistle, vehicular horn, siren, or klaxon repeated several times; or three equally spaced shots with rifle or pistol; or three short bursts of fire from machine gun or submachine gun. In daylight, the individual giving the signal points in the direction of the impending danger; at night, the alarm signal will be supplemented by voice warning to indicate the direction of danger.

## SECTION II

### WHISTLE SIGNALS

■ 288. **GENERAL.**—Whistle signals will be made with the whistle prescribed for the leader or commander concerned and will be confined to ATTENTION TO ORDERS, CEASE FIRING, and AIR OR TANK WARNING.

■ 289. **ATTENTION TO ORDERS.**—Sound a short blast of the whistle. The signal is used to fix the attention of troops, or of their commanders and leaders preparatory to giving commands, orders, or other signals.

■ 290. **CEASE FIRING.**—Sound a long blast of the whistle. This signal will be verified at once by an arm and hand signal or by other means.

■ 291. **AIR OR TANK WARNING.**—Three long blasts, repeated several times (see also par. 287b).

## SECTION III

### GENERAL ARM AND HAND SIGNALS

■ 292. **GENERAL.**—If a movement is to be executed by a particular subordinate unit or units of a command, a signal designating the unit or units will be given before the signal for the movement.

■ 293. **FORWARD; TO RIGHT (LEFT); TO REAR.**—Face and move in the desired direction of march; at the same time extend the hand vertically to the full extent of the arm, palm to the

front, and lower the arm and hand in the direction of movement until horizontal (fig. 86).

■ 294. HALT.—Carry the hand to the shoulder, palm to front; then thrust the hand upward vertically to the full extent of the arm and hold it in that position until the signal is understood (fig. 86).

■ 295. DOWN; OR, TAKE COVER.—Turn toward the unit or group and raise the hand, palm down, in front of the elbow, forearm horizontal; thrust the hand downward and back to this position (fig. 86).

■ 296. DOUBLE TIME; OR, RUSH.—Carry the hand to the shoulder, fist closed; rapidly thrust the fist upward vertically to the full extent of the arm and back to the shoulder several times (fig. 86). This signal is also used to increase gait or speed.

■ 297. QUICK TIME (WALK).—Raise the elbow to a position above and to the right (left) of the shoulder and extend the forearm to the left (right), hand above the head, palm to the front (fig. 86). This signal is also used to decrease gait or speed.

■ 298. CHANGE DIRECTION.—Carry the hand that is on the side toward the new direction across the body to the opposite shoulder and, with the palm down and the forearm horizontal, swing the forearm in a horizontal plane, extending the arm and hand to point in the new direction (fig. 86).

■ 299. ENEMY IN SIGHT.—Hold the rifle horizontally above the head with the arm or arms extended as if guarding the head.

■ 300. AS SKIRMISHERS.—Raise both arms laterally until horizontal, arms and hands extended, palms down (fig. 86). If it is necessary to indicate direction of march, signal FORWARD, moving at the same time in the desired direction.

■ 301. AS SKIRMISHERS, RIGHT (LEFT).—Raise both arms laterally until horizontal, arms and hands extended, palms down; swing the arm and hand on the side toward which the deployment is to be made, upward until vertical and back immediately to the horizontal position; repeat swinging

movement several times; hold the other arm and hand steadily in the horizontal position until the signal is completed.

■ 302. **ASSEMBLE.**—Raise the hand vertically to the full extent of the arm, fingers extended and joined, and describe large horizontal circles with the arm and hand (fig. 85).

■ 303. **ARE YOU READY?**—Extend the arm toward the leader for whom the signal is intended, hand raised, fingers extended and joined, palm toward the leader (fig. 85).

■ 304. **I AM READY.**—Execute the signal **ARE YOU READY** (fig. 85).

■ 305. **COMMENCE FIRING.**—Extend the arm and hand horizontally in front of the body to their full extent, palm of the hand down; move them several times through a wide horizontal arc (fig. 85).

■ 306. **FIRE FASTER.**—Execute rapidly the signal **COMMENCE FIRING**. For machine guns, a change to the next higher rate of fire is required.

■ 307. **FIRE SLOWER.**—Execute slowly the signal **COMMENCE FIRING**. For machine guns, a change to the next lower rate of fire is required.

■ 308. **CEASE FIRING.**—Raise the hand in front of the forehead, palm to the front, and swing it up and down several times in front of the face (fig. 85).

■ 309. **FIX BAYONETS.**—Simulate the movement of the right hand in fixing a bayonet on rifle (fig. 86).

■ 310. **LEADERS JOIN ME.**—Extend one arm toward the leaders and beckon the leaders to you (fig. 85).

■ 311. **SQUAD.**—Extend one arm toward the squad leader, palm of the hand down; distinctly move the hand up and down several times, holding the arm steady (fig. 87).

■ 312. **SECTION.**—Extend one arm toward the section leader, palm of the hand down and describe large vertical circles (fig. 87).

■ 313. **PLATOON.**—Extend both arms toward the platoon leader, palm of the hands down and describe large vertical circles (fig. 87).

■ 314. **WEDGE FORMATION.**—Raise both arms vertical overhead, palms inward and in contact with each other (fig. 87).



ASSEMBLE

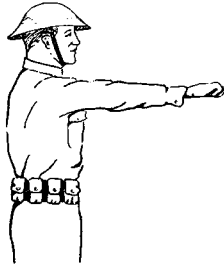

RANGE OR  
CHANGE ELEVATION



ARE YOU READY?  
OR I AM READY

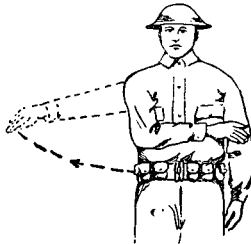

COMMENCE FIRING  
FIRE FASTER  
FIRE SLOWER

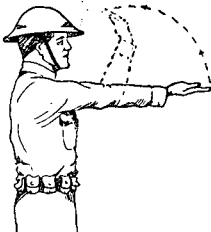

LEADERS JOIN ME



CEASE FIRING

FIGURE 85.—General arm and hand signals.

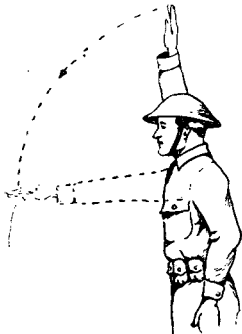

FORWARD OR  
TO THE RIGHT (LEFT)  
OR TO THE REAR



HALT

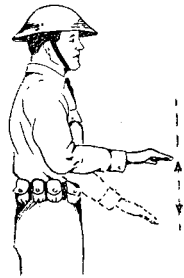

DOWN OR  
TAKE COVER



DOUBLE TIME  
OR RUSH



QUICK TIME

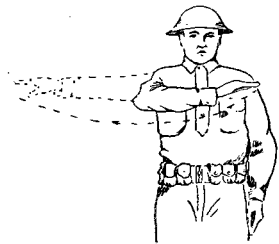

CHANGE DIRECTION

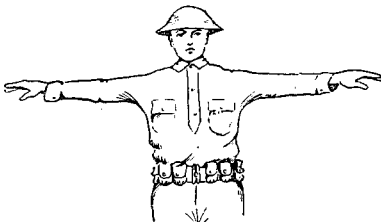

AS SKIRMISHERS



FIX BAYONETS

FIGURE 86.—General arm and hand signals.

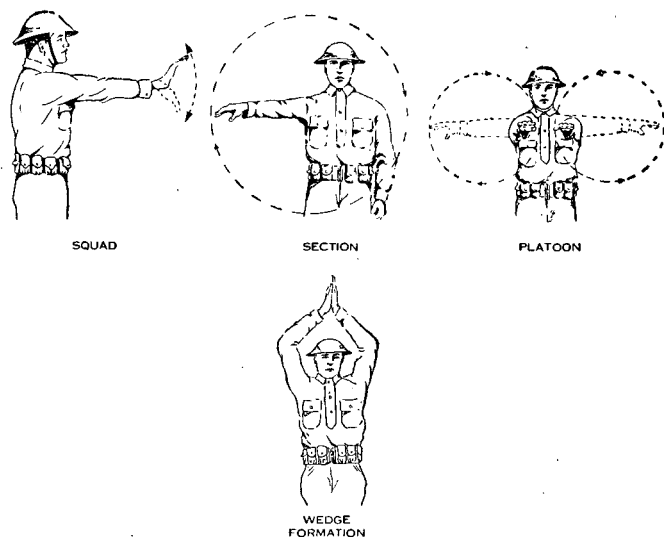

FIGURE 87.—General arm and hand signals.

#### SECTION IV

### ADDITIONAL ARM AND HAND SIGNALS FOR WEAPONS UNITS

■ 315. ACTION AND OUT OF ACTION.—*a. Action.*—Thrust the fist several times in the direction toward which it is desired to go into action.

*b. Out of action.*—Strike the closed fist of one hand rapidly against the open palm of the other several times (fig. 88).

■ 316. ELEVATE; DEPRESS.—Extend one arm toward the gunner(s) concerned; move the hand in short upward (downward) movements by flexing the hand at the wrist; with the palm of the hand toward the gunner(s), expose one finger for each mil the gun is to be elevated (depressed) (fig. 88).

■ 317. SHIFT RIGHT (LEFT).—Extend one arm toward the gunner(s) concerned; swing the hand and arm horizontally in the direction in which the fire is to be shifted, palm turned in that direction; with the palm of the hand toward the gunner(s), expose one finger for each mil the fire is to be shifted.

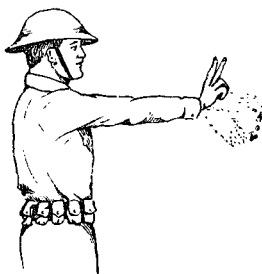

DEPRESS 2 MILS

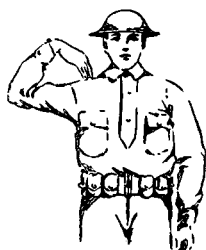

OFF CARTS



ON CARTS



OUT OF ACTION



FIRE ONE ROUND

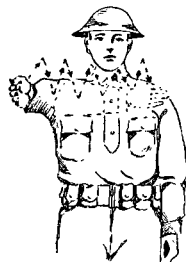

TRAVERSING FIRE

FIGURE 88.—Additional arm and hand signals for weapons units.

☒ 318. OFF CARTS.—Face the unit for which the signal is intended; raise the elbow laterally the height of the shoulder and touch the shoulder with the fingers (fig. 88).

☒ 319. ON CARTS.—Face the unit for which the signal is intended, raise both elbows laterally to height of the shoulders and touch the shoulders with the fingers (fig. 88).

☒ 320. FIRE ONE ROUND.—Extend one arm above the head, toward the gunner for whom the signal is intended. Cut the hand sharply downward (fig. 88).

☒ 321. FIRE FIVE ROUNDS.—Extend one arm above the head, hand open; flex the wrist, making a quick, choppy, lateral movement with the hand.

☒ 322. RANGE; OR, CHANGE ELEVATION.—Extend the arm fully toward the leader or men for whom the signal is intended, with the fist closed. This is the signal for battle sight. Open the fist, exposing one finger for each 100 yards of range. Change elevation by indicating the complete new range.

☒ 323. TRAVERSING FIRE.—Face the target, extend one arm fully to the front; move it upward and downward with a chopping motion, and at the same time swinging the arm to the right (left) in the direction it is desired to distribute the fire (fig. 88).

## SECTION V

### ARM AND HAND SIGNALS FOR MOTOR VEHICLES

☒ 324. GENERAL.—Signals are transmitted by bugles, whistles, voice, and by arm movements. Because of the great extension of convoys in movement, sound signals are of no value except at halts. The bugle may be used in rear areas for such signals as: ATTENTION; ASSEMBLE; and FORWARD. Whistle and voice may be used at halts to attract attention. There is a complete set of arm and hand signals for use in convoy control which may be transmitted both at a halt and in movement. All operating personnel, whether drivers or not, must be thoroughly trained in the use of these signals and impressed with the necessity for the prompt and rapid transmission of signals from one end of the column to the other. In movement, signals are given by the assistant driver who



makes certain that the assistant driver ahead or in rear receives the signal and promptly passes it on.

■ 325. STANDARD SIGNALS.—Standard signals for convoy operation are given below. They should be preceded by the whistle signal ATTENTION TO ORDERS (short blast) when necessary to fix the driver's attention at a halt.

*a. Attention.*—Hand moved above head rapidly from side to side.

*b. Start engines.*—Simulate cranking.

*c. Ready to start.*—Senior in truck stands on running board, faces leader, and gives the arm signal I AM READY.

*d. Forward march.*—Face and move in the desired direction of march, at the same time extend the hand vertically to the full extent of the arm, palm to the front, and lower the arm in the direction of movement until it is horizontal. In starting a convoy, this signal is a warning signal. Immediately after giving the signal, the convoy commander or serial or section leader mounts and directs the driver of his vehicle to start.

*e. Drivers to turn around simultaneously.*—Extend both arms horizontally toward the drivers and describe small vertical circles, then signal forward in the desired new direction. When the distance between vehicles permits and the convoy is long, this signal may be given by a motorcycle messenger passing back along the column.

*f. Mount.*—Extend the arm horizontally to the side, palm up, and wave the arm upward several times.

*g. Dismount.*—Extend the arm diagonally upward to the side, palm down, and wave the arm downward several times.

*h. Stop engines.*—Cross forearms in front of head. Repeat until understood.

*i. Assemble.*—Raise the hand vertically to the full extent of the arm, fingers extended and joined, and describe horizontal circle with the arm and hand.

*j. Close up.*—Extend the arms horizontally, straight to the front, palms in. Move the hands together and then resume first position. Repeat several times.

*k. Increase speed.*—Carry the hand to the shoulder, fist closed; rapidly thrust the fist upward vertically to the full extent of the arm and back to the shoulder several times.

■ 326. DRIVER SIGNALS.—*a. Slow or stop.*—Extend the left arm outward to an angle of  $45^{\circ}$  below the horizontal.

*b. Turn right.*—Extend the left arm outward at an angle of  $45^{\circ}$  above the horizontal.

*c. Turn left.*—Extend the left arm outward horizontally.

*d. Pass and keep going.*—Extend the left hand horizontally and describe small circles toward the front with the hand.

## APPENDIX

### SPECIAL CEREMONIAL PARADE

	Paragraph
General -----	1
Battalion -----	2
Regiment -----	3

■ **1. GENERAL.**—The special parade ceremonies described herein are for use at the option of local commanders in lieu of the regular ceremony prescribed in chapter 9. Training in these special ceremonies is not mandatory.

■ **2. BATTALION.**—*a.* At *Adjutant's Call* the troops without transportation are formed in line with companies in line or in line with companies in mass (or extended mass) formation as for a review but not presented. The battalion commander takes post at a convenient distance in front of the center of, and facing the troops.

*b.* The adjutant takes post between the battalion commander and the center of the troops and commands: 1. **PARADE**, 2. **REST**. After the troops have executed **PARADE REST**, he commands: **SOUND OFF**. The adjutant and the battalion commander with his staff stand at attention during [the *Sound Off*, the marching by of the band, and during the [sounding of retreat.

*c.* The band, in place, plays the *Sound Off* of three chords, and at the conclusion of the third chord moves forward, playing a march in quick time. It executes column left so as to march across the front of the troops midway between the adjutant and the line troops. When the band has passed the left of the line, it countermarches and returns over the same ground to the right of the line. After it passes beyond the right of the troops, it executes column right. When the entire band has passed beyond the front rank of the troops, it again countermarches and halts in its original position. When the band ceases playing the march, the *Sound Off* is again played. At evening parade, *Retreat* is then sounded by the field music. Following the last note and while the flag is being lowered, the band plays the *National Anthem*. The evening cannon salute is fired on the last note of *Retreat*.

*d.* Immediately after the last note of *Retreat*, the adjutant commands: 1. **BATTALION**, 2. **ATTENTION**, 3. **PRESENT**, 4.

## INFANTRY DRILL REGULATIONS

**ARMS.** The adjutant facing the troops then salutes. The troops remain at present arms during the playing of the *National Anthem*. The adjutant then turns about facing the battalion commander, salutes, and reports, "Sir, the parade is formed." The battalion commander directs the adjutant, "Take your post, Sir," and draws saber. The adjutant passes by the battalion commander's right and takes post  $1\frac{1}{2}$  paces to the rear and 1 pace to the right of the battalion commander.

e. The battalion commander then commands: 1. **ORDER**, 2. **ARMS**, and gives such movements in the manual of arms as he may desire. Officers, noncommissioned officers commanding platoons, the color guard, and guidon bearers having once executed the order remain in that position during the movements of the manual.

f. The battalion commander then directs the adjutant, "Receive the reports, sir." The adjutant, passing by the battalion commander's right, advances toward the center of the battalion, halts midway between it and the battalion commander, and commands: **REPORT**.

(1) At the command **REPORT**, the company commanders in succession from the right salute and report, "A (or other) company, present or accounted for"; or, "A (or other) company, (so many) officers or men absent." The adjutant returns each company commander's salute after the report is made and understood. He returns to the carry after acknowledging each salute.

(2) The reports received, the adjutant turns about, salutes, and reports, "Sir, all present or accounted for"; or "Sir, (so many) officers or men absent," including among the absentees those from the band and field music reported to him by the band leader prior to the parade.

g. The battalion commander then directs, "Publish the orders, Sir." The adjutant turns about and commands: **ATTENTION TO ORDERS**. He publishes the orders and then commands: 1. **OFFICERS**, 2. **CENTER**, 3. **MARCH**. After giving the command **MARCH**, the adjutant turns about and takes his post with the battalion commander.

h. At the command **OFFICERS**, all company officers execute **CARRY SABER**, guidon bearers execute **CARRY GUIDON**. When companies are in line, at the command **CENTER**, all company commanders, officers commanding platoons, and guidon

bearers face to the center. When companies are in mass formation at the command **CENTER**, all company commanders and guidon bearers face to the center. Officers commanding platoons step 1 pace forward and face to the center. Officers second in command move around the flank nearest to the center and take post in the column formed by the platoon leaders. At the command **MARCH**, the band plays, officers and guidon bearers close to the center, halt, and individually face to the front; company commanders when moving to the center, oblique to the front and close on a line 4 paces in advance of the line of guidon bearers; guidon bearers close on their own line, each taking post in rear of his own company commander; all other officers close on the line of platoon leaders.

*i.* The officers and guidon bearers having closed and faced to the front, the senior commands: 1. **FORWARD**, 2. **MARCH**. The officers and guidon bearers advance, the center officer of the leading rank being the guide, and march on the battalion commander. The officers and guidon bearers are halted by the senior with the leading rank 6 paces from the battalion commander. They halt and salute the battalion commander, who returns the salute. The battalion commander then commands: 1. **CARRY**, 2. **SABER**. At the first command, the guidon bearers grasp the lance with the left hand, executing the first position of **CARRY GUIDON**, and officers execute **ORDER SABER**. At the second command, the officers execute **CARRY SABER**, the guidon bearers completing the carry guidon. The battalion commander then gives such instructions as he deems necessary, and commands: 1. **OFFICERS**, 2. **POSTS**, 3. **MARCH**.

*j.* At the command **POSTS**, all officers and guidon bearers face about.

*k.* At the command **MARCH**, they step off with the guide as before, the center officer of the leading rank being the guide. The senior commands: 1. **OFFICERS**, 2. **HALT**, so as to halt the leading rank 6 paces from the line of companies when companies are in line and 3 paces when companies are in mass formation. He then commands: 1. **POSTS**, 2. **MARCH**.

*l.* At the command **POSTS**, officers and guidon bearers face outward, and at the command **MARCH**, officers step off in succession at 4 paces distance, resume their posts, and exe-

## INFANTRY DRILL REGULATIONS

cute ORDER SABER; guidon bearers step off with their company commanders, resume their posts, and execute ORDER GUIDON. The music ceases to play when the last officer has resumed his post. During the execution of OFFICERS, CENTER, and OFFICERS, POST, all officers and guidon bearers remain at carry saber and carry guidon except when saluting the battalion commander.

*m.* The battalion commander then gives the commands for the battalion to pass in review and returns saber.

*n.* The battalion passes in review according to the commands and fundamentals given for a review. When the last company has passed, the ceremony is concluded.

*o.* The band continues to play while the companies are in march upon the parade ground. After passing in review, companies are marched to their respective parades and dismissed.

■ 3. REGIMENT.—The regiment is ordinarily formed in line of companies with companies in mass formation. The parade proceeds as for the battalion with the following exceptions:

*a.* "Regimental commander" is substituted for "battalion commander", and "regiment" for "battalion" in the description; and "battalions" for "battalion" in the commands.

*b.* In moving across the front of the regiment, the band passes midway between the adjutant and the line of battalion commanders.

*c.* The battalions execute PRESENT ARMS, ORDER ARMS, PARADE REST, and come to attention at the command of execution of their respective commanders, starting with the center (or right center) battalion and continuing simultaneously toward each flank. Reports are made by battalion instead of company commanders.

*d.* After making his report, the adjutant commands: 1. OFFICERS, 2. CENTER, 3. MARCH. Battalion commanders and their staffs close on the line of battalion commanders, company commanders oblique to the front and close on a line 4 paces in their rear, guidon bearers oblique to the front and close on a line 4 paces in rear of the company commanders, others officers oblique to the front and close on a line 4 paces in rear of the guidon bearers.

*e.* The officers and guidon bearers are returned to their posts and the regiment marches in review as in battalion parade.

## INDEX

	Paragraph	Page
Action and out of action signal.....	315	192
Advance by individuals.....	259	167
Advance, direction.....	268	169
Advance platoon.....	278	178
Air warning, signal.....	287, 291	186, 187
Aline company.....	153	83
Aline squad.....	119	61
Antiaircraft deployment.....	279	178
"Are you ready," signal.....	303	189
Arm and hand signals.....	292-326	187
As skirmishers, signal.....	300-301	188
Assemble, signal.....	302	189
Assemble platoon.....	277	178
Assemble squad.....	262	168
Attention, position.....	16	10
Attention to orders, signal.....	289	187
Automatic rifle, rules for carrying.....	65	35
Automatic rifle squad.....	264-266	169
Aviation, participation of at funerals.....	250	158
Back step.....	28	15
Base squad.....	269	169
Battalion:		
Formations.....	214	120
Inspection.....	242	150
Parade.....	237	146
Cannon salute at funerals.....	249	158
Carry guidon, dismounted.....	85, 86, 90	41, 41, 43
Cease firing.....	64	35
Signal.....	290, 308	187, 189
Ceremonial parade, battalion and regiment.....	2, 3, App.	197
Change direction.....	125, 140, 157, 176, 184, 204	63, 73, 85, 93 101, 109
Signal.....	298	188
Change elevation, signal.....	322	194
Change step.....	31	15
Chapel service for funerals.....	244	152
Chaplain, duties at funerals.....	252	150
Classes of military funerals.....	243	151
Close chamber, dismounted.....	70	37
Close interval.....	120	62
Color guard.....	98	46
Column with battalion in column of threes or fours.....	218	126
Column with battalion in mass formation.....	219	126
Columns of twos.....	129, 146	67, 75
Commander of troops.....	227	132
Commands.....	12	6
Battalion and regiment.....	212	119
Mass.....	13	7
Revoke.....	7	4
Commence firing, signal.....	305	189

INDEX

	Paragraph	Page
Company drill:		
Formations-----	207	114
Rules-----	148	77
Company:		
Formations-----	180	95
Inspection-----	240	147
Movements-----	209	118
Cremation services at military funerals-----	247	157
Count off-----	118	60
Definitions-----	3	2
Deploy:		
Squad columns-----	274	175
platoons as skirmishers-----	275	177
Squads as skirmishers-----	276	178
Deployment, antiaircraft-----	279	178
Deployment, direction-----	267	169
Depress, signal-----	316	192
Direction, partial changes-----	9	5
Dismiss:		
Battalion-----	217	126
Company-----	152, 186, 210	82, 101, 118
Platoon-----	135	71
Regiment-----	225	132
Squad-----	117	60
Dismount, leaving equipment in truck-----	193	104
Dispositions:		
Automatic rifle squad-----	265	169
Rifle platoon-----	270	175
Rifle squad-----	258	162
Distances between men when deployed-----	257	162
Double time-----	6, 23, 93	4, 13, 43
Signal-----	296	188
Draw saber:		
Dismounted-----	105	50
Mounted-----	111	55
Drill:		
Precision-----	4	4
Purposes-----	2	2
Driver signals-----	326	196
Duties of instructor-----	14	9
Elements of a review-----	226	132
Elevate, signal-----	316	192
Enemy in sight, signal-----	299	188
Entruck-----	194	104
Escort of honor-----	236	145
Escort of the color-----	235	144
Extended order:		
General rules-----	255	160
Individual instruction-----	256	161
Eyes right or left-----	18	11
Face in marching-----	29	15
Facings-----	19	11
Field equipment, inspection-----	241	148
Fire:		
By volley-----	63	33
Faster, signal-----	306	189
5 rounds, signal-----	321	194



## INDEX

	Paragraph	Page
Fire—Continued.		
1 round, signal-----	320	194
Rifle-----	62	32
Slower, signal-----	307	189
Firing, general rules-----	59	30
Fix bayonets-----	57	28
Signal-----	309	189
Floral tributes at funerals-----	254	159
Follow squad leader-----	261	168
Form:		
At truck-----	166, 190	89, 102
Column-----	197	106
From line-----	175, 181	93, 95
Of threes or fours-----	158, 183, 202	85, 95, 108
Of twos-----	130	67
Company-----	149	78
Mass-----	155, 182	83, 95
With personnel and loads in vehicles-----	208	114
Extended mass formation-----	156	84
For shelter tents-----	145	74
In line, companies in line (for ceremonies)-----	215	125
In line, companies in mass formation (for ceremonies)-----	216	125
Line-----	197	106
Line from column-----	177, 200	93, 108
Line to front-----	141	73
Platoon-----	134	70
Regiment-----	222	126
Single column from several columns abreast-----	205	112
Squad-----	115	56
With close interval between men-----	151	82
With motor transportation-----	171, 179	90, 95
Formation of platoon-----	132	68
Formation, regiment, variations-----	221	126
Formations:		
Battalion-----	214	120
Company-----	180	95
For company drill-----	207	114
For review-----	229, 230	133, 134
For vehicles-----	196	104
More than one squad-----	131	68
Staff-----	213	119
Forward, signal-----	293	187
Frontage, platoon-----	271	175
Funerals:		
Cannon salute-----	249	158
Ceremony prior to shipment of remains-----	248	158
Classes-----	243	151
Cremation-----	247	157
Duties of chaplain-----	252	159
Floral tributes-----	254	159
Graveside service-----	246	156
Participation of aviation-----	250	158
Participation of organizations-----	251	158
Preliminary arrangements-----	253	159
With chapel service-----	244	152
Without chapel service, but with graveside service-----	245	156

INDEX

	Paragraph	Page
Guide and messenger, posts-----	280	180
Guide, general rules-----	8	4
Guide in marching-----	137	71
Guidon bearer, salute-----	92	43
Guidons, posts-----	11	5
Grouping of recruits-----	15	9
Half step-----	26	14
Halt-----	24, 173, 199	13, 92, 108
Regiment-----	224	132
Signal-----	294	188
Honors-----	232	136
"I am ready," signal-----	304	189
Individuals, position-----	133	70
Insert magazine:		
Dismounted-----	71	39
Mounted-----	79	40
Inspect pistol:		
Dismounted-----	74	39
Mounted-----	82	40
Inspection arms-----	44	24
Inspection of reviews-----	233	139
Inspections-----	239	147
Battalion-----	242	150
Company-----	240	147
Personal field equipment-----	241	148
Instruction:		
By the numbers-----	12	6
Individual, extended order-----	256	161
Recruits-----	33	16
Instructor, duties-----	14	9
"Leaders join me," signal-----	130	189
Left shoulder arms-----	52, 53, 54	27, 27, 27
Line of battalions-----	220	126
Load pistol:		
Dismounted-----	72	39
Mounted-----	80	40
Load rifle-----	60	30
Load trucks-----	167, 191	89, 103
Loading and firing, general rules-----	59	30
Manual of arms for rifle, rules governing-----	35	18
Manual of color and standard-----	95-103	45
Manual of guidon:		
Dismounted-----	84-93	41
General-----	83	41
Mounted-----	94	44
Manual of pistol:		
Dismounted-----	67-75	37
General-----	66	36
Mounted-----	76-82	39
Manual of saber:		
Dismounted-----	105-110	50
General-----	104	49
Mounted-----	111-113	55

INDEX

	Paragraph	Page
<b>March:</b>		
At close interval.....	138	71
At normal interval.....	139	71
By the flank.....	30	15
Forward, being in column.....	172	92
In review.....	234	140
Other than at attention.....	32	15
Platoon.....	136	71
Regiment.....	223	131
To oblique.....	123	62
To flank.....	122	62
To right.....	150	82
Toward flank.....	124, 142	63, 73
Mark time.....	25	14
<b>Mass:</b>		
Commands.....	13	7
Formation.....	157	85
Mechanized attack, warning signal.....	287	186
Messenger, posts.....	260	180
Motor vehicles, signals.....	324-326	194
Move forward, several columns abreast.....	203	109
<b>Movements:</b>		
Company.....	209	118
With motor transportation.....	174	93
Mule, handling.....	161	87
Normal interval.....	121	62
Numbering of units.....	10	5
Numbers, instruction by.....	12	6
Off carts, signal.....	318	194
Officers, posts.....	11	5
On carts, signal.....	319	194
Open and close ranks.....	144	73
<b>Open chamber:</b>		
Dismounted.....	69	37
Mounted.....	78	40
Order arms.....	36, 37, 39, 40, 41, 43, 45, 49, 55, 57, 58	20, 20, 21, 22, 22, 24, 25, 26, 27, 28, 29
Order guidon.....	87, 91	41, 43
Order saber, dismounted.....	108	54
Orders, battalion and regiment.....	212	119
Organization of platoon.....	170	89
Organization of squad.....	114, 165	56, 89
Organizations, participation of at funerals.....	251	158
Parade rest.....	50, 88, 109	26, 43, 54
Parades.....	237-238	146
Partial changes of direction.....	9	5
<b>Platoon:</b>		
Column.....	273	175
Composition and formation.....	132	68
Dispositions.....	270	175
Organization.....	170	89
Signal.....	313	189
Port arms.....	42, 48	23, 26
Port saber, dismounted.....	110	54

INDEX

	Paragraph	Page
Position of individuals.....	133	70
Position of order arms.....	36	20
Position of platoon leader and second in command.....	272	175
Position of soldier or of attention.....	16	10
Positions of the color.....	99-103	48
Posts of guide and messenger.....	280	180
Posts of officers, guidons, and units.....	11	5
Precision in drill.....	4	4
Present arms.....	42	23
Present guidon.....	89	43
Present saber:		
Dismounted.....	106	52
Mounted.....	112	55
Presentation and honors.....	232	136
Purposes of drill.....	2	2
For units with motor carriers.....	162	87
Quick time.....	22	13
Signal.....	297	188
Raise pistol, dismounted.....	67	37
Range, signal.....	322	194
Recruits:		
Grouping.....	15	9
Instruction.....	33	16
Regimental parade.....	237	146
Rests.....	17	11
Return pistol, dismounted.....	75	39
Return saber:		
Dismounted.....	107	52
Mounted.....	113	56
Review:		
Elements.....	226	132
Formations.....	229, 230	133, 134
Inspection.....	233	139
Preparation.....	228	133
Reviewing party.....	231	135
Rifle:		
Rules for carrying.....	34	16
Automatic.....	65	35
Rules for men armed with.....	164	88
Rifle squad, dispositions.....	258	162
Right and left, use.....	5	4
Right shoulder arms.....	46, 47, 51, 56	26, 26, 26, 28
Rules for company drill.....	148	77
Rush, signal.....	296	188
Rushes.....	260	168
Salutes:		
By guidon bearer.....	92	43
By regimental color or standard.....	97	46
Hand.....	20	12
Not rendered by national colors.....	96	46
Scope of manual.....	1	1
Scouts.....	263	168
Use.....	281	180
Section, signal.....	312	189
Shelter tents, to form.....	145	74

## INDEX

	Paragraph	Page
Shift, right, signal	317	192
Side step	27	14
Signals	188	102
Arm and hand	292-326	187
Drivers	326	196
Kinds	287	186
Purpose	286	186
Standard:		
Air or mechanized attack	287	186
Motor vehicles	325	195
Whistle	288-291	187
Sling arms	39	21
Squad:		
Organization	114, 165	56, 89
Signal	311	189
Transportation	160	86
Stack arms	127, 143	64, 73
Staff formations	213	119
Standards, use and care	95	45
Street parades	238	146
Take arms	128	67
Take cover, signal	295	188
Take interval and assemble	126	63
Tank warning, signal	287, 291	186, 187
To right, left, rear, signal	293	187
Trail arms	38, 55	20, 27
Transportation for units with motor carriers	163	88
Traversing fire, signal	323	194
Units:		
Numbering	10	5
Posts	11	5
Unload pistol:		
Dismounted	73	39
Mounted	81	40
Unload rifle	61	32
Unload trucks	168, 192	89, 103
Unslung arms	39	21
Use and care of color and standards	95	45
Use of right and left	5	4
Use of scouts	281	180
Variation in regimental formation	221	126
Vehicle and its load	189	102
Vehicles, formations	196	104
Weapons platoon	285	183
Weapons section	284	182
Weapons squad	283	180
Weapons units, signals	318-323	194
Wedge formation, signal	314	189
Whistle signals	288-291	187
Withdraw magazine:		
Dismounted	68	37
Mounted	77	40

