

Copy 3

FM 24-20

WAR DEPARTMENT FIELD MANUAL

O. K. TO RELEASE
B 12-13-44 J

FIELD

WIRE SYSTEMS



WAR DEPARTMENT • 4 OCTOBER 1944

WAR DEPARTMENT FIELD MANUAL
FM 24-20

This manual supersedes chapter 8, FM 24-5, 19 October 1942; section II, Training Circular No. 67, War Department, 1942; and Training Circular No. 45, War Department, 1943.

FIELD
WIRE SYSTEMS



WAR DEPARTMENT • 4 OCTOBER 1944

*United States Government Printing Office
Washington: 1944*

WAR DEPARTMENT,
WASHINGTON 25, D. C., 4 October 1944.

FM 24-20, Field Wire Systems, is published for the information and guidance of all concerned.

[A.G. 300.7 (16 Aug. 44).]

BY ORDER OF THE SECRETARY OF WAR:

G. C. MARSHALL,
Chief of Staff.

OFFICIAL:

J. A. UL^r,
Major General,
The Adjutant General.

DISTRIBUTION:

As prescribed in paragraph 9a, FM 21-6: 1, 2, 4-7, 17, 18, 44 (5); BN 1, 2 (3), 3-5, 7, 17, 18 (8), 6, 44 (23), 11 (33); IC 4, 5, 7, 44 (5), 11 (10).

IC 4: T/O & E 4-47; 4-232.

5: T/O & E 5-87; 5-367; 5-627.

7: T/O & E 7-14; 7-19.

11: T/O & E 11-7; 11-57; 11-77; 11-147S; 11-217; 11-237; 11-247; 11-287; 11-557.

44: T/O & E 44-7.

For explanation of symbols, see FM 21-6.

CONTENTS

	<i>Paragraph</i>	<i>Page</i>
CHAPTER 1. General	1-11	1
CHAPTER 2. Field wire line construction.		
SECTION I. General	12-24	21
II. Construction	25-40	78
CHAPTER 3. Field telephones and tele- phone centrals.		
SECTION I. Installation	41-54	107
II. Operation	55-67	134
CHAPTER 4. Field telegraph and tele- typewriter installation and operation	68-78	155
CHAPTER 5. Maintenance of field wire systems	79-89	167
Examples of a telephone directory for corps and army.		
APPENDIX		191
INDEX		198

CHAPTER 1

GENERAL

1. PURPOSE AND SCOPE. The purpose of this manual is to establish standard practices for the installation, operation, and maintenance of field wire systems of tactical units. Such standardization is essential to efficient wire communication. The individual duties of wire personnel of various types of units are explained specifically in training publications pertaining to the different arms. Complete technical information about particular items of wire communication equipment is given in references listed in various paragraphs herein and in Technical Manuals listed in FM 21-6.

2. RESPONSIBILITY. a. Commander. Responsibility for signal communication is a function of command and is prescribed in AR 105-15. In general, the tactical commander is responsible for the operation of all agencies and for the installation and maintenance of all means of signal communication that form the signal systems of his own unit. To that end, the tactical commander prescribes the training of all signal personnel under his command, and the application of such training in field operations.

b. Signal or communication officer. In general, the commander of each tactical unit down to the battalion is provided with a special staff officer trained in the tactics and technique of signal communication. This special staff officer is charged, under the direction of

the unit commander (or G-3 or S-3), with the tactical supervision of signal communication for the entire command, and with recommending the necessary measures for the training of personnel in signal communication for combat.

(1) *Ground force units.* In ground force units the special staff officer in a division or higher headquarters is known as the *signal officer*; in units below the division, he is known as the *communication officer*.

(2) *Air force units.* In air force units the communication officer serves as a member of the staff of the commander of the air force, command, or other subordinate unit, and is charged with the duty of coordinating, supervising and directing the tactical employment of the communication facilities, operations and training within the command. The signal officer is the commanding officer of the signal corps unit that is attached to an air force or subordinate unit. He supervises signal installations, maintenance, supply and operations of his unit. He is responsible to the communication officer. See FM 1-45 for additional information on signal communication in the Army Air Forces.

c. Unit. (1) Every unit is responsible for wire communication from its command post to the command post of the next subordinate units. It is responsible also for lateral wire communication between its subordinate units. Lateral communication may be effected through a switching central of the responsible unit, or this unit may install the necessary lateral circuits itself, or direct their installation. In the absence of specific instructions lateral circuits are laid from left to right (AR 105-15).

(2) A supporting unit is responsible for wire communication from its command post to the command post of the unit it supports.

(3) In case of an attached unit, the unit to which it is attached is responsible for wire communication between the two command posts.

3. DEFINITIONS. a. Terms pertaining to signal communication in general.

(1) *Axis of signal communication.* A line through the probable successive locations of a unit's command post.

(2) *Command post.* The establishment set up by the forward echelon of a headquarters during combat, from which tactical control normally is exercised, and to which tactical information is sent from subordinate units.

(3) *Message.* All instructions, reports, orders, documents, photographs, maps, or other intelligence, in plain or cryptographic text, transmitted by a means of signal communication.

(4) *Message center.* The agency of the commander at each headquarters or command post charged with the receipt, transmission, and delivery of messages.

(5) *Rear echelon.* A rear installation of a headquarters consisting of those staff agencies which have primarily administrative and supply duties, and which are not located at the command post.

b. Terms peculiar to wire communication.

(1) *Bridged circuit.* A circuit which is connected in parallel with an existing circuit.

(2) *Circuit diagram.* An illustration in symbol form of the technical arrangement and connections of a wire system.

(3) *Circuit marking tag.* A tag which identifies a field wire circuit.

(4) *Common battery system.* A telephone system which has current supplied to it from a central source.

(5) *Construction center.* An installation, located near or in a command post area, where trunks and long local circuits converge for entrance to the telephone central (see par. 27).

(6) *Construction chief.* A noncommissioned officer in charge of the installation and maintenance of the trunk and long local circuits in the wire system of his unit.

(7) *Cross*. An electrical contact between conductors of two independent circuits.

(8) *Field telephone*. A portable telephone designed for field use.

(9) *Field telephone switchboard*. A portable telephone switchboard designed for field use.

(10) *Gaff*. A spur on the inside of pole climbers which is forced into the pole by the weight of the lineman.

(11) *Ground (on a line)*. An electrical path to earth from one or both conductors of a wire circuit.

(12) *Line route map*. A map, map substitute, or overlay on which is shown the physical location of wire circuits that are installed already, or are to be installed.

(13) *Loading coil*. A specially constructed coil of wire used to increase the talking range of a field wire line by increasing the impedance of the circuit and thereby counteracting the capacitance of the circuit.

(14) *Local*. A wire circuit connecting a telephone to a switchboard or to another telephone.

(15) *Local battery system*. A telephone system in which the current for talking is supplied at each telephone, sometimes called a magneto system.

(16) *Magneto*. A hand-operated a-c generator used to operate telephone ringers and switchboard line indicators.

(17) *Maintenance pool*. A centrally located area from which wire maintenance crews may be sent out quickly to clear trouble on the system.

(18) *Marline*. A small, loosely twisted twine used for tying field wire to a support.

(19) *Monocord switchboard*. A field telephone switchboard in which each line terminates in a single jack and plug.

(20) *Open*. A break in the continuity of a wire circuit.

(21) *Repeater*. A device for amplifying the strength

of a signal in a wire circuit in order to increase the range of the circuit.

(22) *Repeating coil*. A transformer usually of approximately one to one ratio, used to superimpose additional circuits on wire lines.

(23) *Section of a wire line*. That portion of a wire line which begins and terminates at successive centrals, at test stations, or (in the case of long locals) at a telephone.

(24) *Seizing wire*. Soft-drawn copper wire used to improve field wire splices mechanically and electrically.

(25) *Short*. An electrical contact between the two conductors of a wire circuit.

(26) *Sidetone*. The audible sound produced in a telephone receiver when the transmitter of the same telephone set is actuated by sound waves.

(27) *Skinning*. The process of removing insulation from wire.

(28) *Staggering*. The spacing of splices in the two conductors of twisted-pair wire so that the individual splices will not be opposite each other, thus preventing excessive bulk and reducing the probability of shorts.

(29) *Switching central*. An installation in a wire system in which switching equipment is used to interconnect telephone circuits, or to interconnect telegraph circuits.

(30) *Telephone directory*. A list of names and numbers assigned telephones and switchboards within a unit. (See also par. 64.)

(31) *Teletypewriter*. A motor-driven machine similar to a typewriter, which transmits electrical impulses corresponding to a character, and translates such impulses into the same character.

(32) *Terminals*. Conveniently arranged contacts or binding posts to which wires may be quickly connected.

(33) *Terminal strip*. A block of insulating material to which are fastened several binding posts.

(34) *Test point*. A point in a wire line at which tests can be made conveniently.

(35) *Test station*. An installation where circuits may be tested and rearranged.

(36) *Trunk*. A wire circuit connecting switchboards.

(37) *Way station*. A telegraph or teletypewriter connected to a line between and in series with other telegraph or teletypewriter stations.

(38) *Wire chief*. A noncommissioned officer in charge of the installation, operation, and maintenance of short locals, the switchboard, and auxiliary equipment.

(39) *Wire pike*. A pole about 9 feet long with a wire hook arrangement on one end used to place field wire lines off or on a road, or to lift wire over limbs of trees or other obstructions.

4. COMPOSITION OF WIRE SYSTEMS. The wire system of a tactical unit consists of telephone, telegraph, teletypewriter, and facsimile facilities. The wire system is installed by communication or Signal Corps personnel assigned to the headquarters of that unit, or by a Signal Corps organization which is attached to that unit. It includes as much of the following equipment as is necessary to meet the requirements for wire communication:

a. Wire lines, and associated loading and repeating equipment.

b. Connecting equipment installed at construction centers.

c. Switching and terminal equipment installed at switching points along wire lines.

d. Testing equipment installed at test points, test stations, construction centers, and switching installations.

e. Station equipment, including telephones, telegraph instruments, teletypewriters, and facsimile equipment serving various elements of the unit headquarters.

5. CLASSIFICATION OF WIRE CIRCUITS. a. According to use. Wire circuits are classified according to their use as follows:

(1) *Trunk* circuits or trunks, which connect switching centrals.

(2) *Local* circuits or locals (sometimes called loops), which connect telephones to telephone centrals or to other telephones.

b. According to electrical path. Wire circuits are also classified according to the path provided for the electric current, as follows:

(1) *Ground-return* circuits, in which the metallic conductor furnishes only a part of the path for the electric current, the return path being provided by the ground.

(2) *Metallic* circuits, in which the path for the electric current is completed through the metallic conductors. The metallic circuit has proved to be more satisfactory for telephone communication than has the ground-return circuit. It is less susceptible to interference from other circuits and earth currents.

c. When superimposed on other circuits. Additional circuits may be superimposed upon metallic circuits by the use of repeating coils; when this is done, the circuits are classified as follows:

(1) A single metallic telephone circuit may provide an additional telegraph, teletypewriter, or telephone circuit without mutual interference. The additional circuit uses a ground return and is known as a *simplex circuit* (par. 52), and the metallic circuit is said to be simplexed.

(2) Two metallic telephone circuits may provide an additional telephone, telegraph, or teletypewriter circuit without mutual interference. This third circuit is called a *phantom circuit* (par. 53). The two metallic circuits are called *side circuits*, to distinguish them from the phantom circuit, and the three together are known as a phantom group. Such a connection is used in preference to the ground return *simplex circuit* as it provides greater

signal security than is provided by a simplex circuit. The phantom circuit of a phantom group can be simplexed.

6. MOVEMENT OF COMMAND POSTS. The maintenance of wire communication is usually more difficult during the movements of command posts than at any other time. The initial installation of each wire system is planned with the object of maintaining continuous wire communication with subordinate units during and after the movement of command posts. No fixed rules can be given; ingenuity and adaptability are all-important.

7. ORDERS AND INSTRUCTIONS. In corps and higher units, instructions concerning the wire system for a particular operation usually are included in a signal annex to a field order. In divisions and below, the corresponding instructions usually are issued orally. However, the plan of installation can best be shown by a circuit diagram and a line route map. See instructions, forms, and examples in paragraphs 8, 9, and 10.

8. CIRCUIT DIAGRAM. a. Definition. A circuit diagram (fig. 1) is a drawing which shows schematically the technical arrangement and connections of the circuits and terminal installations of the wire system.

b. Content. A circuit diagram indicates the following:

(1) Switching centrals at command posts and at establishments served by the wire system; commercial switching centrals; test stations; and long local telephone circuits (that is, circuits to local telephones not in the immediate vicinity of a switching central). These are shown by special symbols (par. 11), and by telephone directory names or telephone directory numbers. Locations are indicated by the names of map or terrain features and by coordinates. (The commander of the

theater of operations may prohibit the use of map locations, coordinates, unit designations, or symbols when signal security is jeopardized.)

(2) Number of circuits, including trunks and long locals, between the command posts or establishments shown.

(3) Number assigned to each circuit (see par. 9).

(4) Manner of connecting each circuit into or through switching centrals and test stations, including the connections for simplex and phantom circuits.

(5) Type of line construction used for each line, such as field wire, open wire, cable, commercial circuits, etc.

9. DESIGNATING LINES AND CIRCUITS. a. Wire lines and circuits are given individual designations, as published in orders by higher authority.

b. Normally in division wire systems, a circuit is designated not by name but by an individual number.

c. In assigning numbers to wire circuits the following general rules are observed:

(1) No two cables or circuits constructed by the same organization during a single operation are given the same number.

(2) All wire lines are divided into sections. A section is the portion of a wire line which begins and terminates at successive switching centrals or test stations, or which (in the case of long locals) begins at a switching central or test station and ends at a telephone. A cable or circuit passing from one section to another is given a different designation when it enters a new section.

d. In the wire system of divisions and lower units, construction and maintenance are facilitated by a numbering system which identifies the general position of each circuit with respect to other circuits in the same system.

e. In figure 1, the number to the left of the dash is the circuit number while the number to the right of the

Annex No. 1 to Annex No. 3 to Field Order No. 6, 4th Infantry Division
 Circuit Diagram, 4th Infantry Division, Effective 0001Q, 6 June 1944

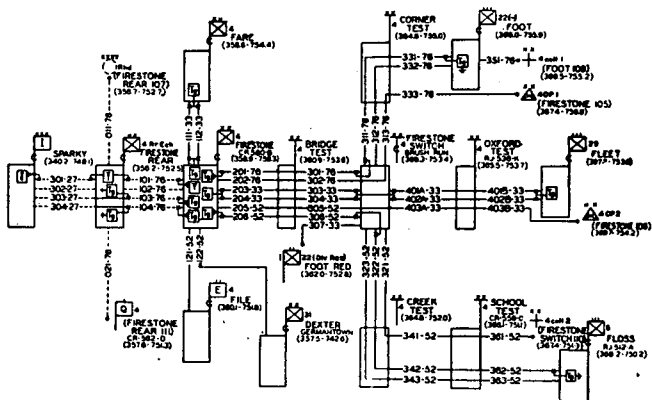

Figure 1. Example of circuit diagram.

dash is the designation of the unit or construction team that laid the circuit. In this case the three division construction teams were given the designations 33, 52, and 76. The circuits that follow the division axis have zero (0) for the tens (second) digit; laterals to the left of the axis use odd numbered tens digits while those on the right use even numbered tens digits. Normally any circuit along the axis has its circuit number increased by one hundred when it passes from one section to one farther forward; the circuit numbers of lateral lines increase by twenty when they pass from one section to another. In the example the OXFORD TEST was installed after the circuits had been laid and numbered so, instead of changing the entire number, the circuits in the two sections were assigned a letter to follow the number.

10. LINE ROUTE MAP. a. General. A line route map is a map, map substitute, or overlay, suitably titled, on which is shown the actual or projected routes of wire

circuits. A line route map does not show the actual connections at switching centrals or test stations (see fig. 2). The principal use of a line route map is to report the physical location of wire circuits as actually laid. This information is for the use of wire personnel. On an overlay, at least two orientation points taken from the map must be shown and a reference made to the map used (unless the commander of the theater of operation directs otherwise). The line route map contains as few lines, symbols, and notations as are consistent with its purpose. It shows the location of each headquarters or establishment served by the wire system; locations of switching centrals, test stations, and long locals; the type of line construction; and the number of physical circuits in each section of the line.

Line Route Map of 4th Inf. Div. as of 000Q, 6 June 1944
 Special Map No. 6, 1935 AEC

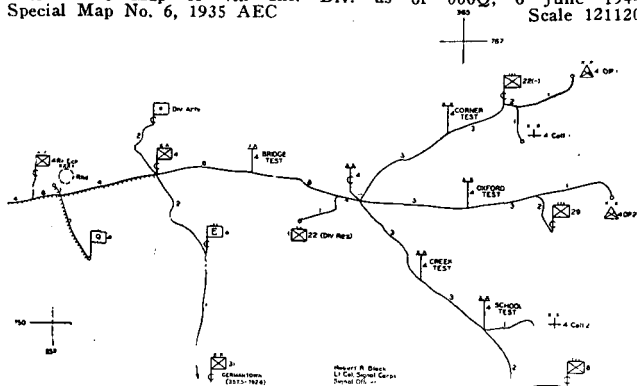



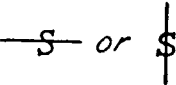
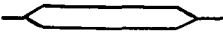

Figure 2. Example of line route map.

b. Security. Because of the ever-existent possibility of capture by enemy patrols, mechanized units, or parachute troops, *complete* circuit diagrams and line route maps should never be taken into forward areas. Individual construction and maintenance teams will carry with them only such extracts as pertain to their par-

ticular mission. *Such extracts should not show unit designations.*

11. SPECIAL SYMBOLS. The following special symbols are authorized for use as indicated in FM 21-30 and TM 11-462:

a. Basic symbols for circuit diagrams of tactical wire systems.

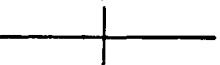
<i>Meaning</i>	<i>Symbol</i>
(1) Line circuit (or circuits) of insulated conductors, one pair unless otherwise indicated. (Field wire indicated by this symbol is generally on the ground unless otherwise designated.)	
(2) Open wire line circuit (conductors separately supported on insulators and overhead supports), one pair unless otherwise indicated. <i>Where applicable, this symbol will be substituted for the basic symbol in (1) above.</i>	
(3) Single conductor line circuit. Use only where necessary for clarity.	
(4) Two line-circuit pairs operated in parallel as a single circuit. Each pair serves as a single conductor but is designated as a separate circuit.	
(5) Channels or circuits connected electrically.	
(6) Channels or circuits crossing on a diagram but <i>not</i> connected electrically.	

Meaning

Symbol

- (7) Loaded line circuit or circuits.

Symbol generally placed near the ends of the circuit or circuits.



- (8) Interrupted (or cut) channel or circuit. May be used to show the interruption of circuits which extend into enemy territory.

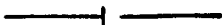

- (9) Dead-ended channel or circuit.



- (10) Repeating coil (simplex coil) on a line circuit. The simplex leg is shown at right angles to the through line circuit.



- (11) Single-conductor ground-return circuit grounded through communication equipment. Where applicable, the appropriate symbol for the equipment will replace the square; for example a small circle for a telephone.

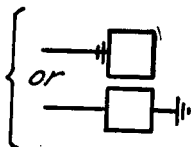



- (12) Cable terminal or test station.

(The \top , Φ , \square or Φ of this and the following symbols must be placed within, close to, or connected to the rectangle, so that the meaning is clear.)





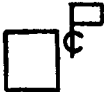
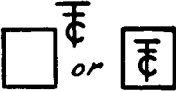

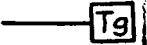
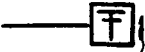
- (13) Telephone central *not* at a command post or headquarters.

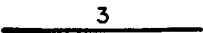

- | <i>Meaning</i> | <i>Symbol</i> |
|---|---|
| (14) Telephone central at a command post or headquarters. |  |
| (15) Teletypewriter switching central. |  |
| (16) Telephone or telephone set |  |
| (17) Manual telegraph set (operated by telegraph key). |  |
| (18) Teletypewriter (page printing) |  |

b. Basic symbols for traffic diagram of tactical wire systems.

- | <i>Meaning</i> | <i>Symbol</i> |
|---|---|
| (1) Direct channel or channels.
(The number indicates channels available.) |  |
| (2) Telephone or telephones (small circle). |  |
| (3) Telephone central (large circle), |  |
| (4) Teletypewriter (page printing). |  |
| (5) Teletypewriter central, switching, manual, or relay (large circle). (Include equipment identifying symbol within circle.) |  |

c. Basic symbols for line route maps of tactical wire systems.

<i>Meaning</i>	<i>Symbol</i>
(1) Telephone (small circle).....	○
(2) Wire line, on ground.....	— 5 —
(3) Wire line, buried or underground.	— 2 —
(4) Wire line, aerial (on overhead supports).	— 10 —

Note. The number of *physical pairs* in a wire line is indicated by a small number placed on the line, as 5, 2, and 10 above. If desirable, additional appropriate designations of wire or cable types, sizes, or material may be added in parentheses.

d. Basic symbols for military organizations and installations.

<i>Meaning</i>	<i>Symbol</i>
(1) Test station or cable terminal	T
(2) Telephone central <i>not</i> at a command post or headquarters.	⊕
(3) Telephone central at a command post or headquarters.	☐ ⊕
(4) Teletypewriter switching central.	⊕
(5) Message center	✉
(6) Point on the axis of signal communication (probable future location of a command post or headquarters)	└

Note. This symbol is intended to be one half of the rectangle of the basic symbol for a command post or headquarters, so that it can be completed when the headquarters or command post occupies that location.

Examples

AF	☐	FA	└
Armd	☐	Inf	└
Comd	☐		
Cav	└	Mecz	☐
		Cav	☐

Meaning

Symbol

- (7) Symbols representing commercial installations may be designated by the company name or initials, and/or the abbreviation for "commercial" shown at the right.

coml

Note. The end of the staff of these symbols is drawn to the actual location of the installation on maps or map overlays. There should be a slight space between the end of the staff and any line indicating a wire line on line route maps.

e. Applications of basic symbols for military organizations and installations.

Meaning

Symbol

- (1) Telephone central at the command post of the FIRST Army.



- (2) Telephone central at the command post of the II Corps.



- (3) Telephone central at the command post of the 3d Infantry Division.



- (4) Telephone central at the command post of the 4th Field Artillery Battalion.





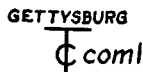

- (5) Gettysburg commercial telephone central.

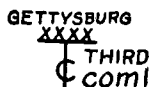

- (6) Gettysburg commercial telephone central controlled or operated by THIRD Army.

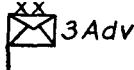

<i>Meaning</i>	<i>Symbol</i>
(7) Point on the axis of signal communication of the 4th Infantry Division.	
(8) Point on the axis of signal communication of the 2d Field Artillery Battalion.	
(9) Test station of the FOURTH Army.	
(10) Telephone central of the 38th Division, not at a command post.	
(11) Teletypewriter switching central of the VII Corps.	
(12) Advance message center of the 3d Division.	

f. Application of basic symbols and designations for circuit diagrams of tactical wire systems.

Meaning

- (1) Telephones connected together by field wire circuit O41-99.
- (2) Method of indicating the individual conductors of field wire circuit 347-89 and drop-wire circuit 417-7.
- (3) Group of five circuits in field cable number 101-371.
- (4) Circuits dead-ended close to and at a test station terminal, and other circuits connected through that terminal strip.
- (5) A manual telegraph set or teletypewriter connected to the simplex circuit of a pair ending at a telephone or telephone central.

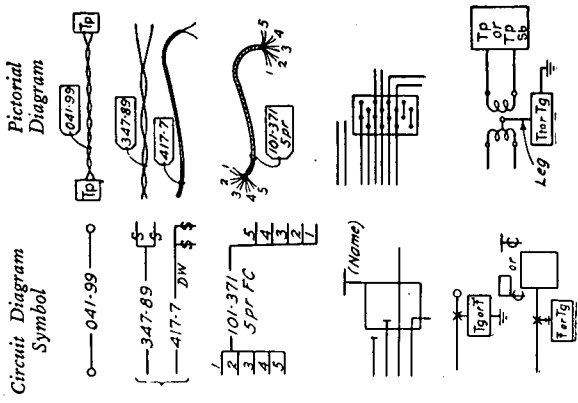

(6) Simplex circuit bridged around a telephone central.

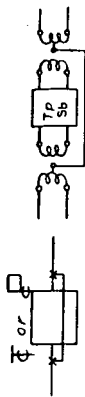

(7) Manual telegraph, set as a way station on a simplex circuit where the telephone circuits terminate in a telephone central.

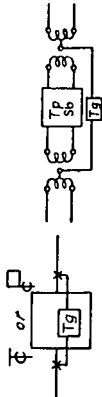

(8) Teletypewriter as a way station on a simplex circuit where the telephone circuit is bridged around the telephone central.

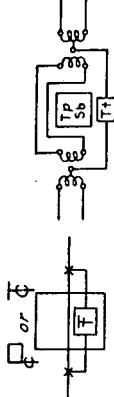

(9) Phantom group entering a telephone central.

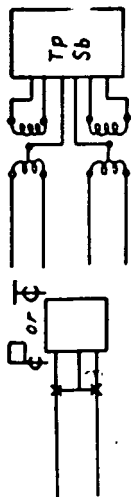

(10) Side circuits of two phantom groups entering a telephone central, and the phantom circuit bridged around that central.

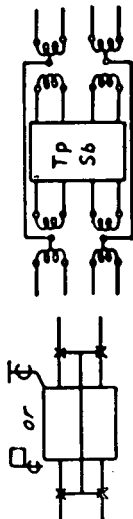

Meaning

(11) Phantom group entering a telephone central, with the phantom circuit simplexed for manual telegraph operation.

Circuit Diagram Symbol

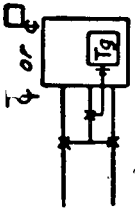

Pictorial Diagram

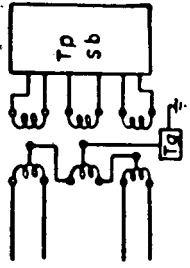

(12) Two phantom groups entering a telephone central, with the simplexed circuit on the phantom bridged around the central.

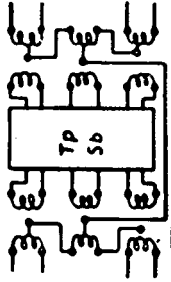
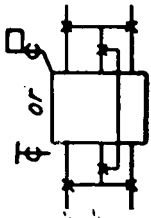

(13) Superimposed metallic return telegraph circuit with a way station.

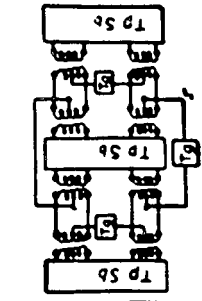
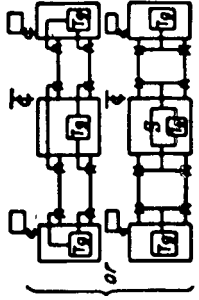

CHAPTER 2

FIELD WIRE LINE CONSTRUCTION

Section I. GENERAL

12. CHARACTERISTICS OF FIELD WIRE. Field wire is wire used for signal communication, and has the following characteristics:

- a. Flexible conductors (usually stranded).
- b. Relatively high tensile strength.
- c. Good conductivity.
- d. Weatherproofed insulation, with good resistance to abrasion.
- e. Capable of being handled easily and laid rapidly by small teams, either by hand or with a minimum of equipment.

13. TYPES OF FIELD WIRE AND FIELD CABLE.

a. Field wire can be divided into two general types. One type has a twisted pair with conductors individually insulated, but without over-all covering; the second type consists of one pair, either parallel-lay or twisted, with an over-all covering. Included in the first type is Wire W-50, W-110-B, W-130, and W-130-A. Wire W-110-B is used by Signal Corps units, the Infantry, Field Artillery, Corps of Engineers, etc.; Wire W-130, and W-130-A, often called "assault wire," is used generally by the Infantry and the Corps of Engineers. Assault wire is lighter, has a lower tensile strength, higher electrical resistance, and less resistance to abrasion than the other

types. Although Wire W-50 is no longer being procured, some units may have a supply on hand that is being used in training. Included in the second general type of field wire is Wire W-143, which is a two-conductor parallel-lay wire with an over-all covering.

b. Field cable is divided into two general types. The first type includes Cable Assembly CC-345 (5-pair), and Cable Assembly CC-355-A (10-pair). The second type, Cable Assembly CC-358 (spiral-four), consists of four spirally twisted conductors covered with a shielding tape, that in turn is covered with a steel wire braid to give mechanical strength, and over this is an over-all heavy covering of rubber or synthetic rubber. For additional information on Cable Assembly CC-345-A, see TM 11-371; for Spiral-four Cable Assembly CC-358, see TM 11-369.

14. CAPABILITIES OF FIELD WIRE. The physical and electrical characteristics of a wire determine whether or not it will be able to meet the requirements of a particular situation. For information concerning the characteristics of the various types of field wire see TM 11-462.

15. FIELD WIRE SPLICES. a. **General.** Splices in a field wire line are vulnerable points in the circuit; therefore, sufficient time, material, and effort must be applied to make the splices properly. A poorly made splice creates unnecessary additional line loss and may unbalance the line to such an extent that it becomes noisy and completely disrupts communication. A poorly made splice may require considerable time to find since, externally, it usually looks like any other splice in the line. Every enlisted man engaged in signal communication work should be able to make a satisfactory wire splice. The ideal goal is to make spliced wire as mechanically strong and as electrically perfect as unspliced wire, but, in practice, this goal cannot be attained. Accordingly,

the main consideration is to maintain in spliced wire certain characteristics of unspliced wire which are of primary importance. These characteristics include tensile strength, electrical conductivity, insulation resistance, protection against weathering and abrasion, flexibility, and compactness. In attempting to make the splice so as to maintain these characteristics, the time available must be carefully considered.

b. Elements of wire splice. A wire splice, meeting the above requirements, consists of a square knot bound with a seizing wire and covered with insulating tape.

(1) *Square knot.* A square knot joining the two ends of a conductor will not pull out.

(2) *Seizing wire.* A flexible field wire of high tensile strength will have, of necessity, a number of steel strands which are difficult to manage because of the temper of the wire. The natural tendency of the strands to spring up prevents the splice from remaining tightly wrapped, and the ends of the steel strands tend to puncture the insulation and render the splice unserviceable. To prevent this, seizing wire is wrapped around the conductors after the square knot has been tied, thus keeping the strands in place. The binding effect of the seizing wire on both ends of a spliced conductor, together with the large contact area, produces a splice of high and constant electrical conductivity. Under conditions of variable conductivity, such as may exist in a splice made by a square knot alone, a circuit becomes noisy and interferes with communication. If a wire conductor is sufficiently flexible, it can be wrapped on a small radius without spreading, and seizing wire can be dispensed with in a properly made splice such as the splice described for Wire W-130 (par. 15e).

(3) *Insulation.* The primary reason for insulating a splice is to render the resulting circuit as satisfactory electrically in wet weather as in dry weather. Electrical insulation adequate to serve this purpose requires a

minimum of two layers of rubber tape and two layers of friction tape (see par. 17).

(4) *Bulk*. The physical size of an insulated splice is no criterion of its ability to withstand service conditions satisfactorily. If properly made, a field wire splice is flexible enough for service use, and its bulk will not affect seriously the wire capacity of a reel. (Reel capacity is determined primarily by the ability of personnel to wind wire smoothly and uniformly.) Usually, extremely bulky splices indicate that the men who made the splice need further training.

c. Standard field wire splice for Wire W-110-B. When two men are available, the over-all time needed to make the splice can be reduced greatly if the men have a standardized and efficient method of working together. Only the teamwork splice is described below; obvious modifications of the procedure can be made if one man is working alone.

(1) *Staggering splice* (fig. 3). Each man prepares one of two wires that are to be spliced together. To ob-

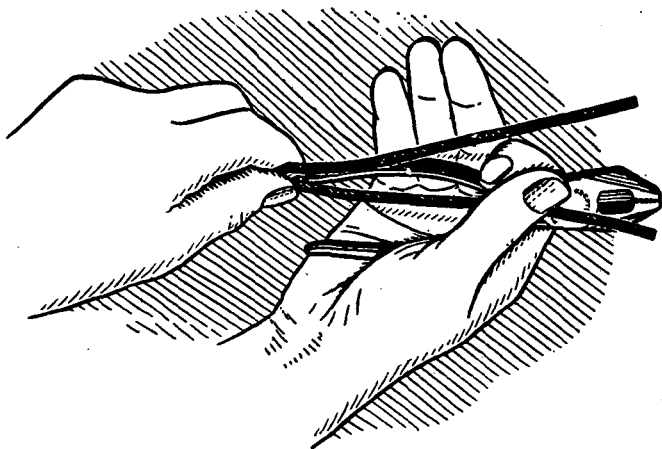

Figure 3. Staggering splice.

tain a uniform stagger that will insure equal tension on both conductors when the splice is completed, each man measures back one plier's length (about 6 inches) from the end of one conductor of the wire pair he is preparing, and cuts off this length of the conductor. Each man now has two conductors, with one cut so that it is one plier's length shorter than the other.

(2) *Crushing insulation.* Each man now begins crushing the insulation on the long conductor at the point one plier's length from the end (see fig. 4). Using the

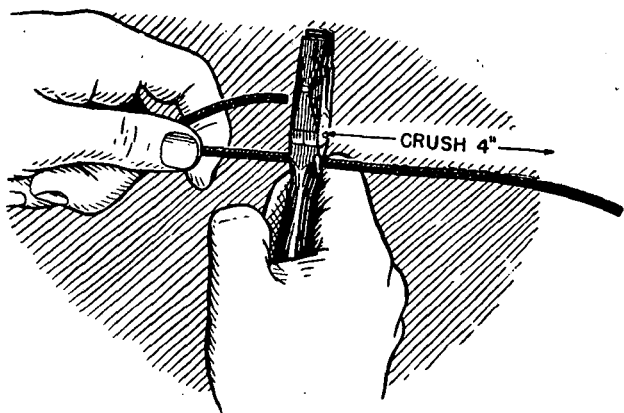

Figure 4. *Crushing insulation on long conductor.*

heel of his pliers, he crushes the insulation toward the end for a distance of about 4 inches, leaving about 2 inches of the insulation uncrushed on the end of the conductor. He next measures back one plier's length along the short conductor, and, in a similar manner, crushes about 4 inches of its insulation (see fig. 5). The uncrushed insulation remaining on the ends of the conductors holds the strands of the conductors together, prevents possible injury to the splicer by the steel

strands, and greatly reduces the over-all splicing time. (With some types of pliers, it may be necessary to improvise shims from sheet metal in order to crush the insulation.)

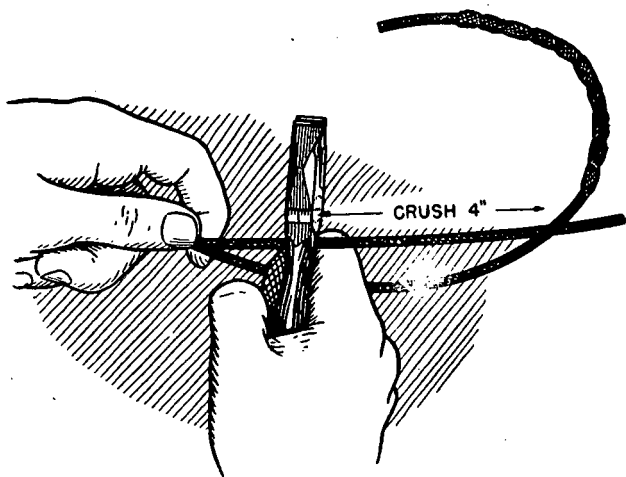

Figure 5. Crushing insulation on short conductor.

(3) *Skinning conductor.* Each man scores or rings the crushed insulation of both conductors with the cutting edges of his pliers, at a point on the crushed section about $\frac{1}{2}$ inch from the point at which the crushing began. He strips about $3\frac{1}{2}$ inches of insulation from the conductor by gripping the insulation lightly with the cutting edges of the pliers and drawing them straight along the conductor, thus pushing the insulation ahead of the pliers (see fig. 6). In this operation, care must be taken to draw the pliers *perpendicularly* along the conductor, since drawing them at any appreciably different angle will nick or break the strands. The skinning may be done by using the gripping jaws or the heel of the pliers, rather than the cutting edge; although this

method is slower, it involves less danger to the strands. If the strands still have bits of insulation adhering to them after stripping, the strands are scraped carefully with the back of the screw driver blade of Knife TL-29. The entire procedure of staggering the splice, crushing the insulation, and skinning the conductors should not take more than 1 minute.

CAUTION: The procedure explained in (2) and (3) above is varied slightly for synthetic insulated Wire W-110-B. The first $\frac{1}{2}$ inch of insulation ($5\frac{1}{2}$ to 6 inches from the end of the wire) on this type of wire is crushed lightly, using only enough pressure to loosen the braid; then, when the additional $3\frac{1}{2}$ inches has been crushed and removed, the braid on the $\frac{1}{2}$ -inch section is pushed back exposing the undamaged insulation. If this is not done, the cracks in that $\frac{1}{2}$ inch of insulation will be a constant source of trouble especially in wet or damp areas.

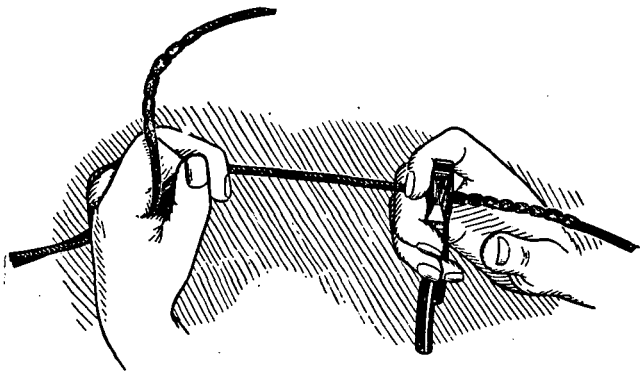

Figure 6. *Skinning conductor.*

(4) *Tying square knot.* Now the ends of the two wire pairs are brought together, and each man ties the long conductor of one pair and the short conductor of the other pair in a square knot, as shown in figures 7

and 8. The knot is tightened only partially at this time. Care is taken to restore the original twist of the two conductors before tying the knot. The square knot is placed so as to leave a distance of about $1/4$ inch between the knot and the rubber insulation. Then the weather-proof braid of the conductor is peeled back from the $1/2$ inch of exposed rubber insulation to allow the rubber tape to adhere closely when it is applied.

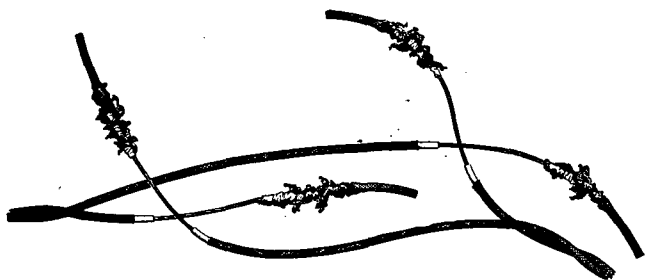

Figure 7. Wires skinned and ready for square knots.

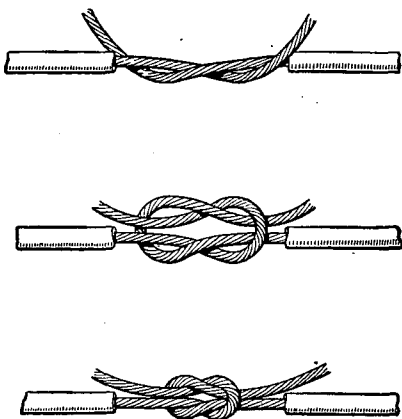

Figure 8. Tying square knot.

(5) *Applying seizing wire.* A 6- to 8-inch piece of seizing wire is inserted through the square knot, and the knot is pulled tight (see fig. 9). The seizing wire is bent so that half can be used for wrapping to the left, and half for wrapping to the right. Two or three close turns are taken with the seizing wire, both to the left and to the right of the square knot (fig. 10), to bind the knot before the ends of the line wire are cut-off. Then the excess ends of the conductors are cut flush with the rubber insulation. The seizing wire wrap is continued, both left and right of the square knot, until two turns are taken on the rubber insulation (see fig. 11). Now the ends of the seizing wire are cut-off and pressed down into the rubber. With both men tying the square knots and applying the seizing wire at the same time, the over-all time for these operations should be about 1 minute (see fig. 12). Tape the splice as described in paragraph 17b.

(6) *Seizing without seizing wire.* Where seizing wire is not available, the copper strands of the conductor are used to seize the square knot. After the square knot has

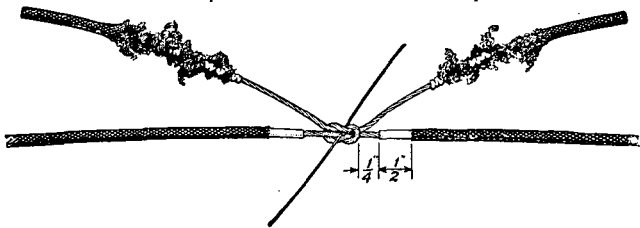

Figure 9. Seizing wire inserted through knot.

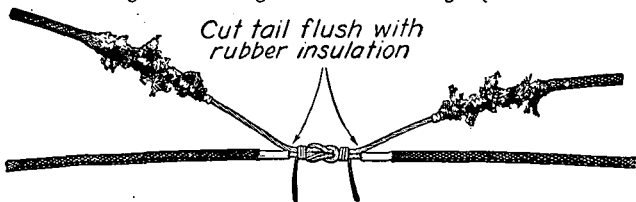

Figure 10. Wrapping seizing wire.

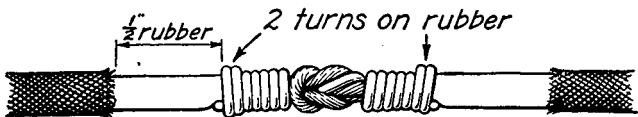

Figure 11. Splice of one conductor after seizing is completed.

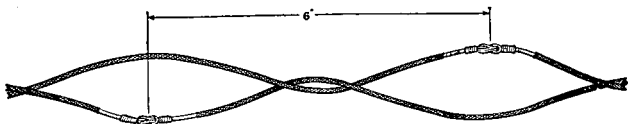

Figure 12. Splice ready for taping.

been tied and pulled tight, separate the steel strands from the copper strands and cut off the ends of the steel strands of both conductors flush with the ends of the rubber insulation. Copper strands may be identified readily in the dark by touch, as they are more flexible than the steel strands. Cross the left-hand tail end of the copper strands over the crest of the square knot; then wrap several turns closely over the bared portion of the right-hand conductor, and continue until two turns have been taken on the exposed rubber insulation. Cut off any excess on the end of the wrap and crimp the seizing strands into the rubber insulation. Repeat this seizing with the right-hand tail end, again crossing over the crest of the square knot and wrapping the tail end around the left-hand conductor.

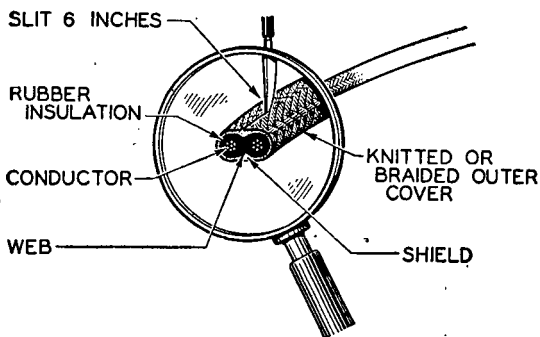

Figure 13. Slitting outer cover of Wire W-143.

d. **Standard splice in Wire W-143.** To make the standard splice in Wire W-143, slit the outer cover with a knife point for a distance of 6 inches (see fig. 13). Do not cut the rubber insulation. Remove the outer cover and shield, leaving the rubber insulation exposed (see fig. 14). Nick the rubber web with a knife, and split the conductors for 5 inches, leaving 1 inch unsplit. With the cutting edge of the pliers, remove 4 inches of rubber from the end of each conductor (see fig. 15). Join the conductors with a square knot, seize the splice in the manner described for Wire W-130 in e below, and tape as explained in paragraph 17b(2).

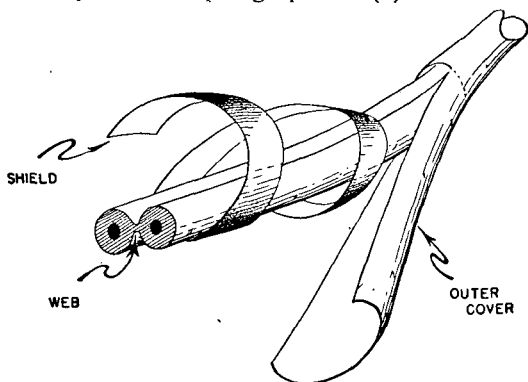

Figure 14. Removing outer cover and shield of Wire W-143.

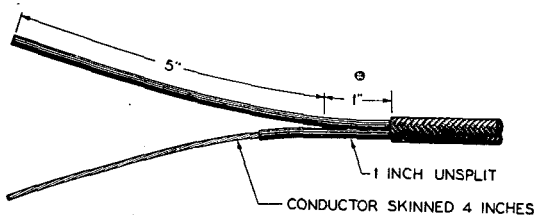

Figure 15. Conductors of Wire W-143 separated, one skinned.

e. **Splicing Wire W-130.** To splice Wire W-130, cut off one conductor of each pair a plier's length (about 6

inches) from the end. Bare about 3 inches of each conductor by holding the pliers as shown in figure 6; clamp the jaws lightly and draw the pliers toward the end of the wire. The remaining 3 inches of insulation on the end of the conductor keep the strands of the conductor from fraying. Tie a square knot in one wire; then cross the left-hand short end over the crest of the knot, wrapping several turns closely around the bared part of the right-hand conductor and two or three turns around the rubber insulation (see fig. 16). Cut off the excess flush with the wire. Repeat with the right-hand short end, again crossing the crest of the knot and wrapping around the left-hand conductor. The other conductor of the pair is tied in the same manner. Tape the splice as described in paragraph 17b. This splice will not loosen when tension on the wire is relieved, and it has adequate electrical conductivity.



Figure 16. Splicing Wire W-130.

f. **Splicing rubber-covered cable.** Complete instructions for splicing 5- and 10-pair rubber-covered cable are included in TM 11-371. The method of splicing spiral-four cable is covered in TM 11-369.

16. SPECIAL WIRE SPLICES AND CONNECTIONS. a. **Western Union splice** (see fig. 17). The Western Union splice is used in splicing two solid-conductor insulated wires. To make the splice, strip the insulation from the end of each wire for a distance of about 8 inches and scrape the wires clean. Twist the bared wires together in the center for a distance of about $1\frac{1}{2}$ inches. Then bend the ends at right angles to the axis of the wire and wrap each end around the wire for at least five close turns. The twisted part of the splice

is called the "neck" and the five close turns at each end are called the "buttons." Cut off the ends as close as possible, being careful not to leave a sharp point that will puncture the tape wrapping. See paragraph 17b(3) for the taping of this splice.

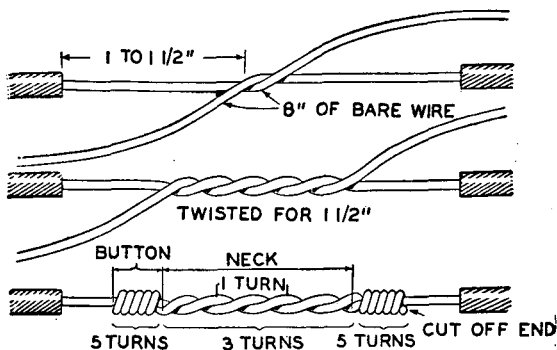

Figure 17. Western Union splice for solid conductors.

b. Combination splice (see fig. 18). The combination splice is used to splice a stranded-conductor insulated wire to a solid-conductor insulated wire. To make the splice, strip the insulation from the end of each wire for a distance of about 6 inches and scrape the wires clean. Tie an overhand knot (first half of a square knot) in the stranded wire about $\frac{1}{8}$ inch from the insulation, and slip the knotted wire over the solid wire to within $\frac{1}{2}$ inch of the insulation. Pull the knot tight and wrap the end of the stranded wire around the solid wire, wrapping from the knot to the insulation. Cut off the surplus stranded wire. Bend the end of the solid wire back at the knot; with this, seize the stranded wire, wrapping as far as the insulation. Wrap the solid wire in the direction opposite to that of the wrappings of the stranded wire, or the solid wire will fail to hold the strands in place. Continue the wrapping of the solid wire until two turns are taken around the insulation.

Cut off the surplus solid wire and press the end down into the insulation. See paragraph 17b(3) for the taping of this splice.

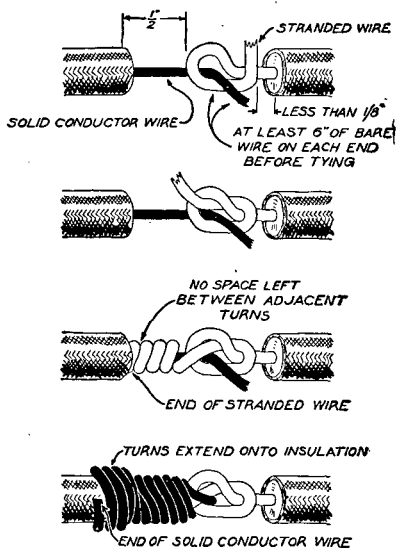

Figure 18. Combination splice, solid to stranded conductor.

c. **Bridging connectors.** A bridging connector (fig. 19) is used to connect stranded insulated wire to bare solid-conductor wire, as in joining a field wire line to an open-wire pole line. To make the connection, clean the solid-conductor wires at the bridging point with abrasive cloth or the cutting edge of the pliers, exercising care not to damage the wires. Place the bridging connectors in position on the solid wires (top wire in fig. 19), and fasten them securely by means of the hexagonal nut. Skin and clean the ends of the insulated wire, and wrap the bared ends around the threaded part of the connector between the two washers. Fasten securely by tightening the nut.

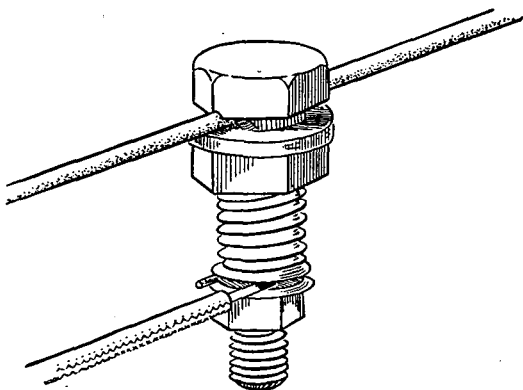

Figure 19. Field wire connected to open wire by bridging connector.

d. **Combination seizing wire splice** (fig. 20). This splice is used to connect an insulated stranded conductor to a bare solid conductor, such as is used on an open wire pole line when bridging connectors are not available (see fig. 31). To make the splice, strip about 1 inch of insulation from the end of the stranded wire, and clean both the stranded and bare wires. Lay the bared end of the stranded wire along the solid wire. Begin the seizing by taking four turns with the seizing wire around the solid wire in back of the stranded wire. Continue the wrapping, taking several turns over the insulation

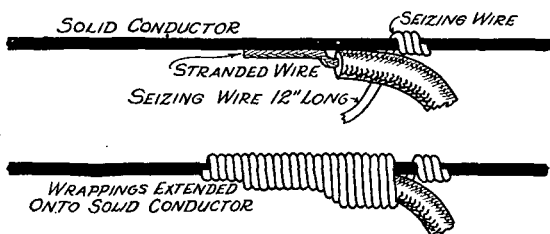

Figure 20. Combination seizing wire splice, stranded to solid conductor.

of the stranded wire, then over the bare end of the stranded wire, and finally four turns over the solid wire. Wrap the seizing wire tightly and draw the turns against each other. Tape the splice as described in paragraph 17b(4).

e. **Commercial splice** (fig. 21). The commercial splice is used to connect an insulated solid conductor and a bare solid conductor, as used on an open-wire pole line when bridging connectors are not available. To make the splice, remove the insulation from the insulated wire for a distance of about 6 inches, and clean both the insulated and bare wires. Lay the bared end of the insulated wire along the bare wire. Bend this end at right angles to the bare wire, and wrap it around the bare wire for at least eight turns, drawing the turns tight and close together. Cut off the surplus end of the insulated wire. See paragraph 17b(3) for the taping of the splice.

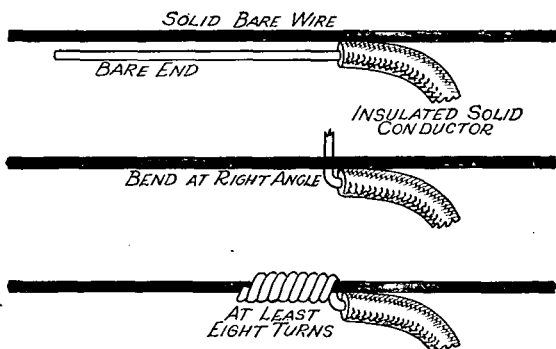

Figure 21. Commercial splice, solid to solid conductor.

f. **T-splice**. The T-splice is used to splice one wire to another without interrupting the circuit of which the latter is a part. In figure 22, X is the wire in the circuit and Y is the wire to be connected. In this illustration it is assumed that after the splice is completed, the portion

of X to the left of the splice will be discarded and that the strain will be toward the right. The following steps are involved in making the splice:

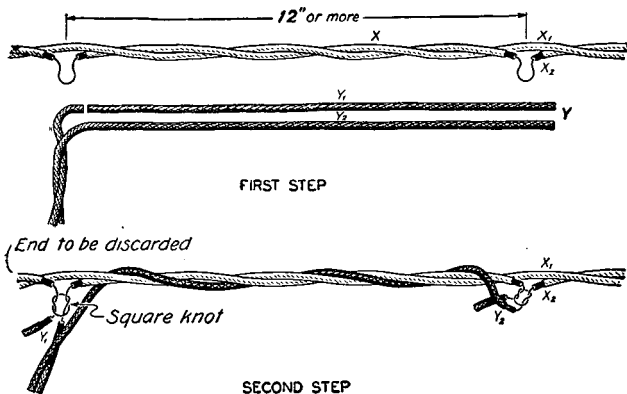

Figure 22. T-splice.

(1) Remove about $1\frac{1}{2}$ inches of insulation from each of the conductors of X (X_1 and X_2). The two bared places should be 12 or more inches apart.

(2) Place the conductors of Y (Y_1 and Y_2) besides X, with the ends of Y_1 and Y_2 at one of the bared places (X_2).

(3) Cut Y_1 off at the other bared place (X_1), and prepare the ends of Y_1 and Y_2 for splicing, as described in paragraph 15c(2) and (3).

(4) Tie Y_1 to X_1 with a square knot. To tie this knot, make a loop with the left hand in the bared part of X_1 ; with the right hand, pass the end of Y_1 up through the loop, over the right side of the loop, under the neck of the loop, over the left side of the loop, and down through the loop; draw the knot tight. To avoid making a thief or granny knot, be sure that the two conductors on which the strain is to be placed are on the same side of the loop; otherwise the knot will not hold.

(5) Twist Y_2 around X_1 and X_2 . Then tie Y_2 to X_2 , as described in (4) above.

(6) Cut off the portion of X to be discarded, and complete the splice as indicated in paragraph 15c.

17. TAPING SPLICES. a. The insulation on wire splices is subject to the same electrical and mechanical stresses as the insulation on the wire itself. It is therefore important that a wire splice be taped adequately to insure good mechanical protection and high insulation resistance. This can be accomplished by taping the splice with both rubber and friction tape. The rubber tape makes the splice as nearly watertight as possible and the friction tape protects the rubber tape against abrasion, deterioration from sunlight, or other weather conditions.

b. Figure 23 shows the relative effectiveness of combinations of rubber and friction tape for insulating field wire splices. In this graph, the insulation resistance of new wire is taken as the standard of reference and evaluated at 100 percent. The vertical scale represents the ratio, in percent, of the actual insulation resistance of the given splice covering, to the standard insulation resistance of the uninjured, new wire. The horizontal scale gives the immersion time of the splices in water. The curves indicate the percentage of normal insulation resistance during successive hours of immersion. The curves shown are not correct necessarily for all taped splices, as the quality of the tape used as well as the care with which the tape is applied to the splice will affect the comparison. The curves in figure 23, however, do show correctly that the insulation resistance of splice coverings will be progressively less the longer the splice remains in water, and that the rate at which the resistance decreases varies between wide limits for the various combinations of insulation. It is evident from figure 23

that two layers each of rubber and friction tape will provide the best insulation combination of those shown.

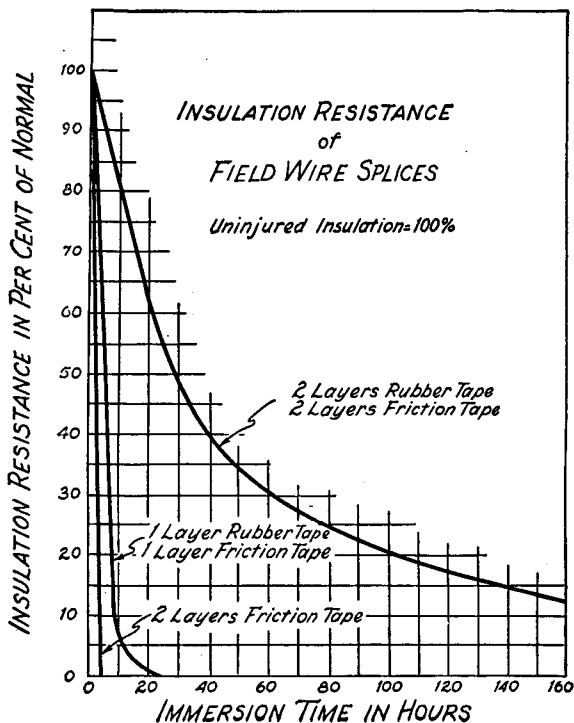

Figure 23. Insulation resistance of field wire splices.

(1) *Taping splice in Wire W-110-B and W-130.* In taping the field wire splice using the teamwork method, one man holds the wire taut and the other applies two layers of rubber tape to the splice. The taping is started at the center of the splice and is worked to the left or right of the knot until 1/2 inch of the rubber insulation on the conductor has been covered. The tape is worked back again over the knot until 1/2 inch of

rubber tape covers the rubber insulation at the other side, and finally back again so that it ends at the center of the splice (see fig. 24). The rubber tape is stretched considerably during winding in order to give close adhesion, and is pressed against the rubber insulation on both ends of the splice to make it waterproof. Then two layers of friction tape are wrapped in the same manner over the rubber tape. The friction tape is extended about 1 inch beyond the rubber tape (fig. 25), and then rolled several times in the hands to seal the edges of the tape. This results in an over-all taped splice of about 4 inches on each wire of the pair.

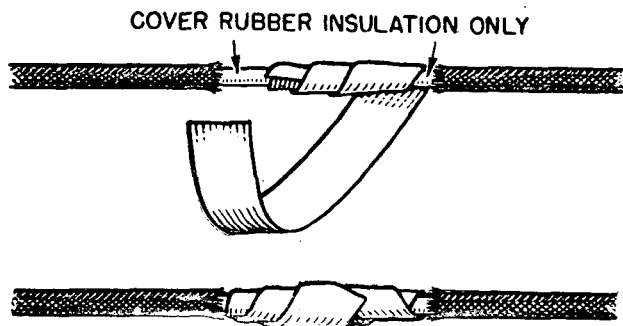

Figure 24. Applying rubber tape.

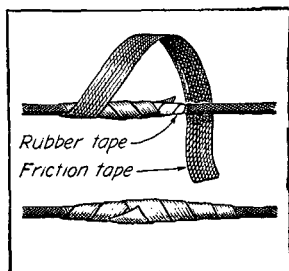

Figure 25. Applying friction tape.

(2) *Taping splice in Wire W-143.* Apply two layers of rubber tape to each splice, as described for Wire W-110-B. Then, a 4-inch piece of rubber tape, start wrapping at a point 1 inch from the crotch of the splice and make two tight turns around the nearest wire (fig. 26①). This is followed by two tight turns around the unsplit portion of the pair. Then the tape is brought over the crotch, spaced evenly so that it covers each side of the crotch as shown in figure 26②. Then one close turn is made to cover the crotch lap on the opposite

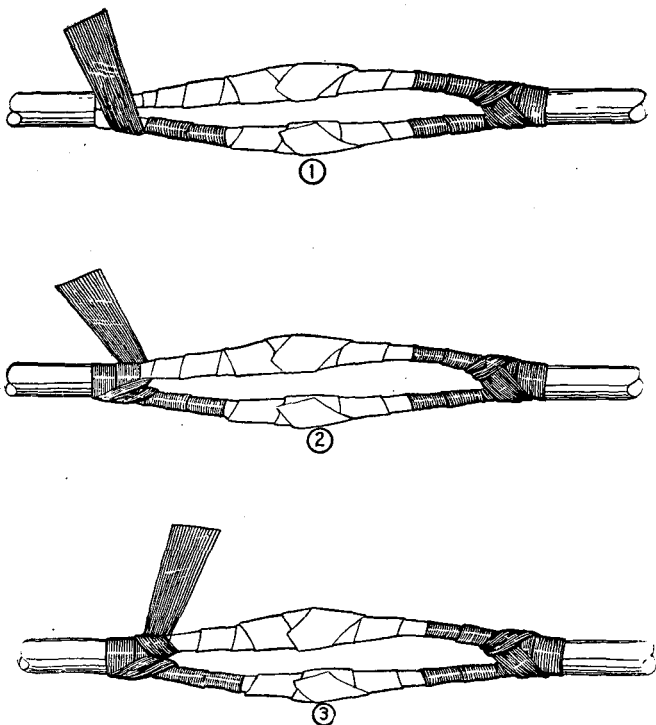

Figure 26. Applying rubber tape to splice in Wire W-143.

wire, and two additional turns are made around the wire to complete the operation (fig. 26③). When the rubber taping is completed, two layers of friction tape are applied over the two conductors. This taping is started at the center of the splice, and is worked to right or left for a distance of 1 inch on the outer braid; then it is brought back to the other end, extended over the braid for 1 inch, and finished in the center (see fig. 27). Roll the completed splice between the hands to obtain good adhesion.

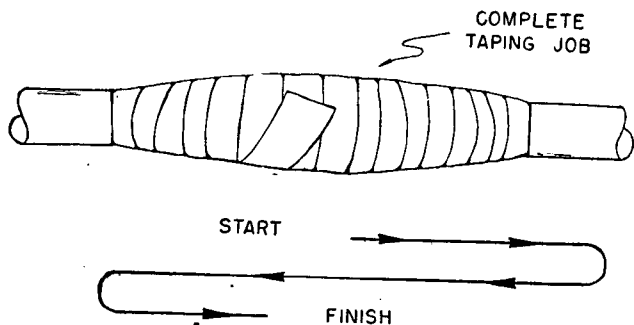

Figure 27. Applying friction tape to splice in Wire W-143.

(3) *Taping Western Union and combination splices.* Western Union and combination splices (par. 16a and b) are taped in the same manner as described for the field-wire splice in Wire W-110-B (par. 17b(1)).

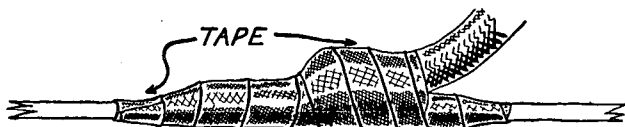

Figure 28. Taping an insulated conductor spliced to bare wire.

(4) *Taping splice of insulated wire to bare wire.* Insulated wire spliced to bare wire (pars. 16c and d) is wrapped with two layers of rubber tape and two layers of friction tape. The purpose is to help hold the wires firmly in place, and to reduce corrosion due to the effects of weather. Figure 28 illustrates the completed and insulated splice, and the method used to extend the wrappings of the tapes on the solid conductor well beyond the actual contact region of the two conductors.

18. WIRE TIES. a. **General.** Field wire lines usually terminate at the binding posts of a terminal strip or an instrument, and any strain placed on the wire tends to pull it away from the binding posts. To avoid this, the wire is fastened securely to a convenient tree, pole, or other support before being connected to the binding posts. Wire lines are tied in also at various points where it is necessary to hold the wire in place. Several kinds of ties, suitable for all conditions encountered in field wire line construction, are described below. Where the

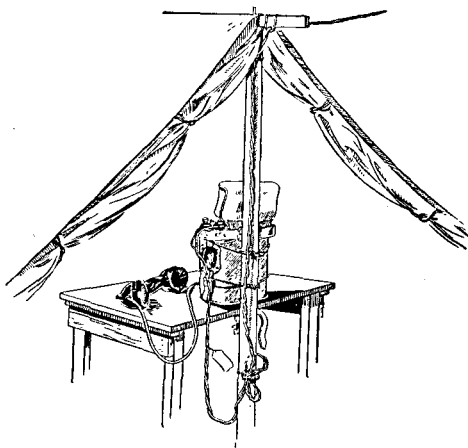

Figure 29 Field telephone installed in tent.

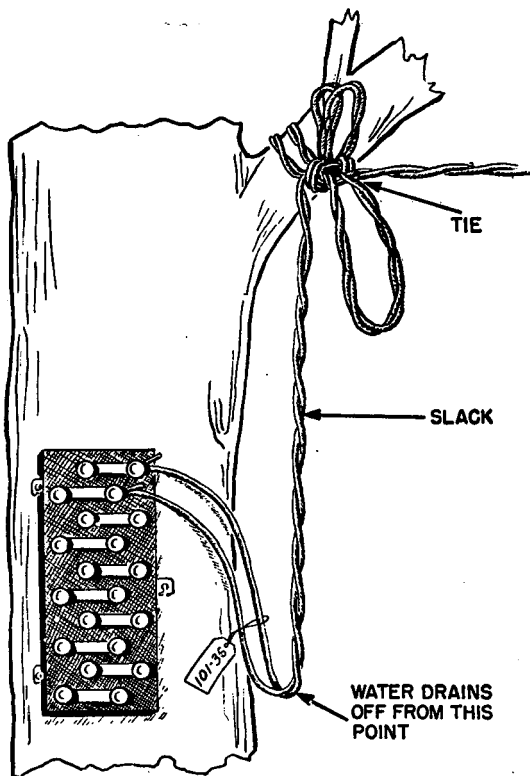

Figure 30. Drip loop in wire leading to a terminal strip.

wire is tied above equipment to which it is to be connected, such as a telephone or terminal strip, a drip loop (figs. 29 and 30) is made in the wire. The drip loop allows water running down the wire to drip from the bottom of the loop and prevents it from being led to the terminal strip of the instrument, where it might cause a short circuit or damage the equipment.

b. Tying in field wire to open wire (fig. 31). Normally, stranded wire is connected to solid conductor wire

only where it is necessary to connect a field wire to an open-wire line. The stranded wire is tied to the cross arm or pole (but never to the metal brace) near the point where the splice is to be made. A little slack is left between the tie and the splice. The tie should take the strain, since the splice is not strong enough to withstand a heavy pull. The tie should be positioned on the cross arm or pole in such a manner that the stranded wire will not touch any of the solid conductors except at the splice.

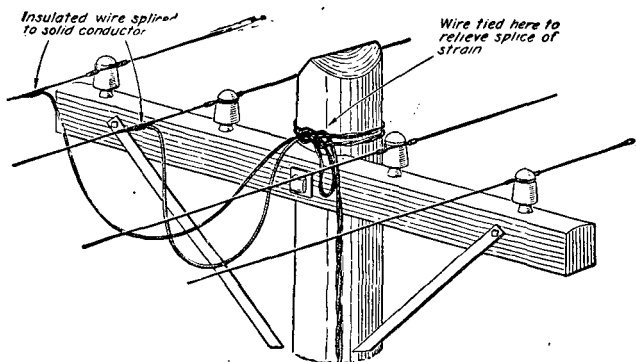

Figure 31. Tying in field wire to open wire.

c. **Clove hitch tie.** When the end of the object to which the wire is to be tied is exposed so that the wire may be placed over it, the clove hitch tie is used. To make this tie, take two loops in the wire (fig. 32①). Place the right-hand loop on top of the left-hand loop without turning either loop (fig. 32②). Place both loops over the object to which the tie is to be made, and pull them tight (fig. 32③).

d. **Other knot ties.** (1) *General.* When the end of the object to which the wire is to be tied is not exposed, one of the three ties described below may be used. Generally these ties are not suitable for overhead construc-

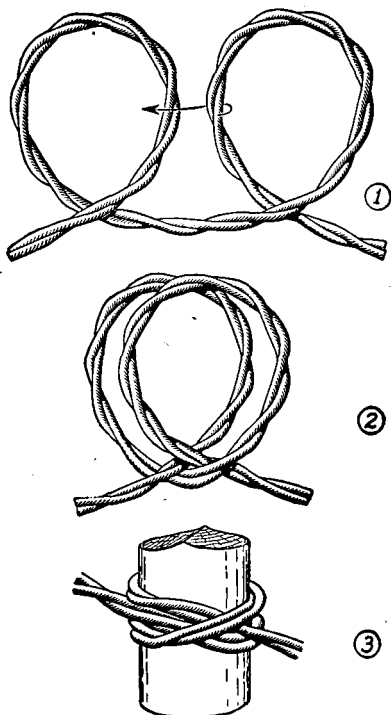

Figure 32. Clove hitch tie around a stake.

tion because they increase the physical length of the line and, when under tension, increase the probability of electrical trouble. Therefore, other ties such as the basket hitch, or marline tie, should be used for overhead construction whenever possible. All three of the following ties permit tying the wire without cutting it. For simplicity, figures 33 and 34 show only one of the two conductors of the field wire. In each of these figures, the *standing part* is the part of the line which has already been laid, and the *running end* is the part leading to the wire-laying equipment. This may be reversed if the

strain is in the other direction. A *wire bight* is a loop formed by the wire, so that the two parts of the loop lie alongside each other.

(2) *Loop knot tie.* (a) The loop knot tie is satisfactory for hasty construction with Wire W-110-B and may be used for short, temporary, overhead spans under temperate climatic conditions. The loop knot tie should not be used in long or permanent overhead spans, nor where it may become untied accidentally by passing personnel, vehicles or animals.

(b) To make the loop knot tie, stand facing the object on the side on which the wire is being laid. Pull in enough slack to make a bight to go around the object with about 2 feet of bight left over. If, during the tying operation, the greater strain is on the standing part, place the bight around the object in the direction of the running end and continue around to the front on the side toward the standing end (see fig. 33①). (If the greater strain is on the running end, place the bight around the object in the opposite direction.) Bring the bight under and then over both the standing part and the running end, forming the front V-opening shown in figure 33①. Reach through this opening and pull through it about 6 inches of the doubled bight, as shown in figure 33②. Tighten the tie, being sure that it rests against the object.

(c) An alternate method of making a satisfactory loop knot tie is as follows: after placing the bight around the object (fig. 33③), hold the bight in the left hand, pass the right hand under the standing part and running end, and then grasp the bight holding the right hand palm up (fig. 33④). Turn the hand in a counterclockwise direction, pulling the loop under the standing part and running end (fig. 33⑤). Double the bight and pass it over the line and into the loop, pulling the bight until the knot is tight and against the object (fig. 33⑥). To

untie, pull the free end of the bight through the opening. The wire will fall away from the object.

(3) *Square knot and loop tie.* (a) This tie is more secure than the loop knot tie. However, it is not suitable for all field conditions. The square knot and loop tie

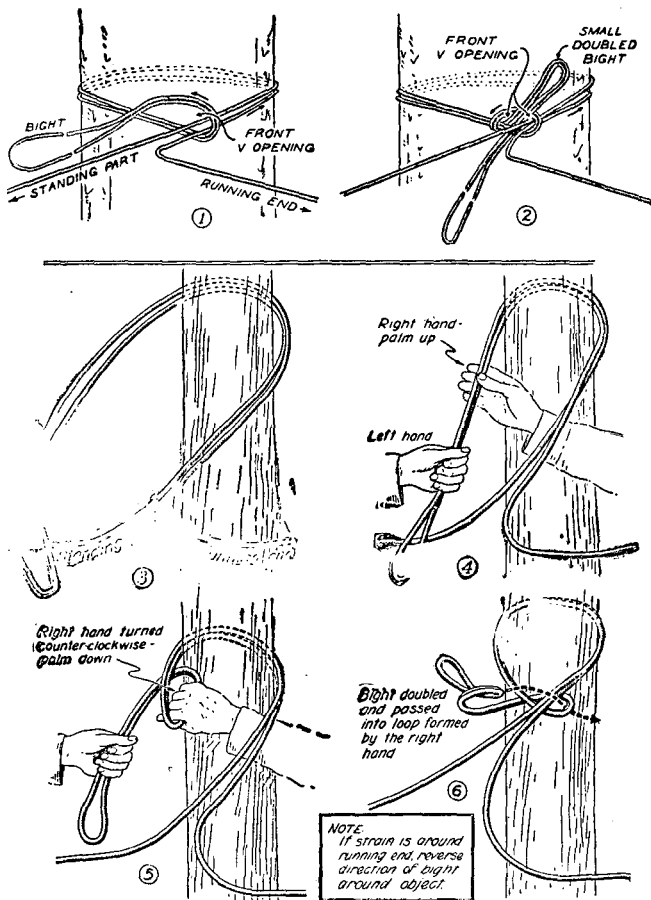

Figure 33. Loop knot ties, showing only one of the two conductors.

should not be used in extreme heat, or for installations that are expected to remain in use for a long time.

(b) To make the tie, begin as in the case of the loop knot tie, but bring the bight over both the standing part and the running end, and then between the object and the wire (fig. 34①). Draw this knot tightly against the object. Bring the bight over the running end, forming the opening (fig. 34②). Reach through this opening and pull about 6 inches of the doubled bight through (fig. 34③). Tighten the tie by holding the doubled bight in one hand and pulling the running end with the other. To untie, pull the free end of the bight through the opening and then untie the bight from the object.

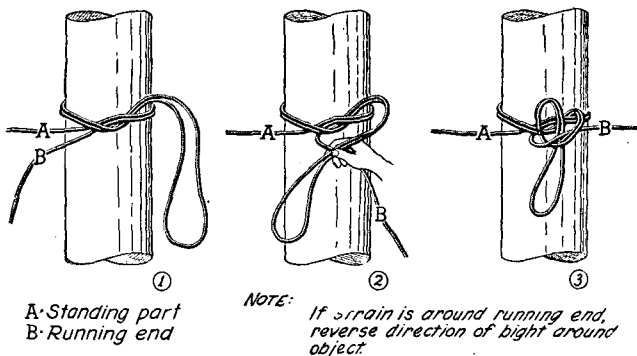

Figure 34. Square knot and loop tie, showing only one of the two conductors.

(4) *Square knot tie.* (a) This tie, although more secure than those described in (2) and (3) above, is subject to the same limitations regarding climatic conditions and overhead spans.

(b) To make the square knot tie, proceed as with the square knot and loop tie, but pull the end of the bight through the opening and tighten it by holding the end of the bight in one hand and pulling the running end

with the other (see fig. 64). To untie, reverse the above procedure. After the knot has been tied and is under strain for some length of time, it is more difficult to untie than are the ties described in the preceding subparagraphs.

e. **Knob tie** (fig. 35). The knob tie is used in tying field wire to a knob or insulator. It is not suitable for tying over larger objects. To make the knob tie, proceed as follows: form a loop in the wire, separate the two conductors in the loop, bend each conductor back around its side of the length of wire so that they again touch each other at a point 180° from the original position of the loop. Place the loop over the knob and draw it tight. This tie will not be electrically satisfactory in extreme heat after 90 days, and is not satisfactory for long spans.

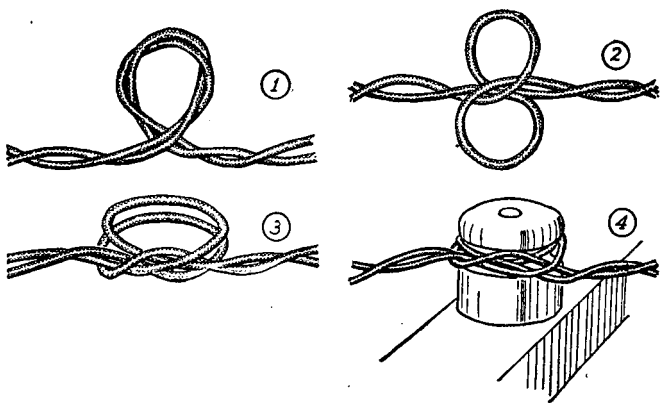
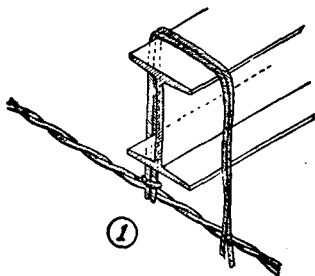

Figure 35. Knob tie.

f. **Marline tie**. The marline tie may be used to support a field wire line on a knob, cross arm, or other support, when there is a possibility that the support in question may damage the insulation of the wire. To make the marline tie, take a piece of marline which, when doubled, will reach from the wire in its sus-

pended position, twice around the support and down to the wire again, with about 4 inches left over for tying. Insert the ends through the loop formed in the middle



①

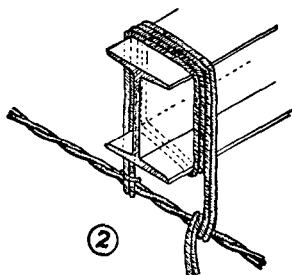

②

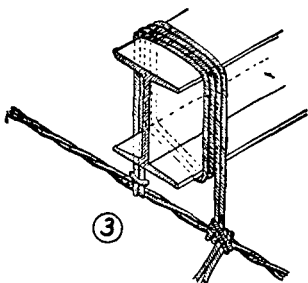

③

Figure 36. Marline tie to a metal support.

of the marline, and draw the marline tight around the wire as shown in figure 36①. Pass the doubled marline twice around the support and back to the wire as shown in figure 36②. Tie the marline securely to the wire with a clove hitch knot. To tie this knot, place the marline around the wire and pass the running ends over the standing part to form a loop. Then pass the running ends down through this loop as shown in figure 36③. Draw the knot tight.

g. Basket hitch tie. The basket hitch tie will be used as an aerial tie for Wire W-110-B under conditions of extreme heat, long spans, heavy wind, or sleet loading. It will be used in all climates to tie Wire W-143 on aerial fixtures, or to a stake or other ground support. To make the basket hitch tie, take a single conductor of scrap Wire W-110-B, about 10 to 12 feet long, and make a clove hitch around the wires being supported. Weave the tie wire around the wire to be supported, as shown in figure 37, taking care to have one portion of the tie

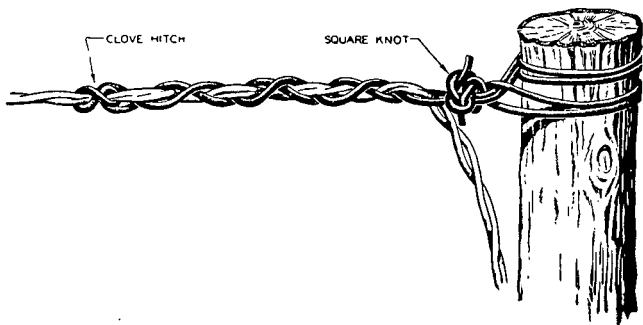

Figure 37. Basket hitch tie.

wire on the inside of one cross and on the outside of the next cross. When tied in this manner, the gripping action will be evenly distributed for the entire length of the tie. Usually seven cross-overs will be sufficient

to hold the supported wire. To complete the basket hitch tie, hold the two tie wire ends together and make one and one-half turns around the support. Separate the two ends and take them around the standing part of the tie wire in opposite directions. Tie the two ends together with a square knot and cut off all excess wire. If the supporting structure is in midsection, the line should loop around the pole or tree in such a manner that it will not come in contact with the support (see fig. 38). Practice will indicate the proper spacing between the two ties.

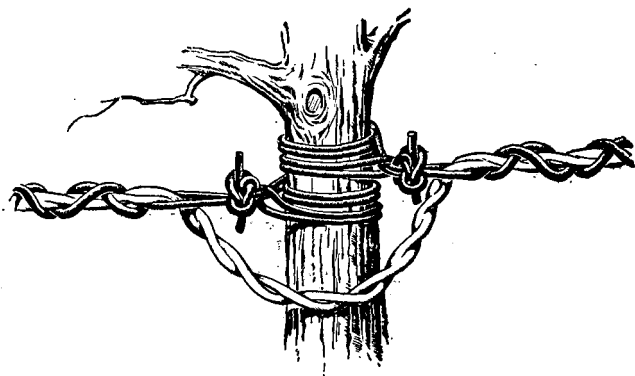

Figure 38. Basket hitch tie in midsection of line.

h. Variation of basket hitch tie. This tie is well suited for use in jungles since the wire line itself contains no knots. The method of suspension allows for considerable swaying of the tree or other support without placing an increased strain on the wire. This type of tie allows suspension from a horizontal or vertical support and is the same whether the tie is in midsection or at the first or last pole. This tie has the disadvantage of being slow to make and must be made at the point of suspension and cannot be started on the ground as is the case with

the normal basket tie. To make the tie (fig. 39) take a piece of scrap wire (W-110-B), loop it twice around the tree or other point of support and tie a square knot leaving the free ends of the tie wire 2 or 3 feet long. Twist these ends together into a double twisted pair for about 6 inches and tie an overhand knot (first half of a square knot), insert the line to be suspended between the two pairs of tie wires and tie a square knot. Untwist the remaining ends of the two pairs of tie wires and wind each pair in opposite directions along the wire to be suspended. This is done in the same manner as the basket hitch tie described above. Be careful to have each strand of the tie wire on the outside of one cross and the inside of the next as in the basket hitch tie. After four or five cross-overs, tie the ends of each pair of tie wires in a square knot and cut off the excess wire.

i. Sag in line. Sag in the line is one of the most important factors affecting the performance of the line. Lines inadequately sagged are a constant source of trouble. Too much attention cannot be given to obtain-

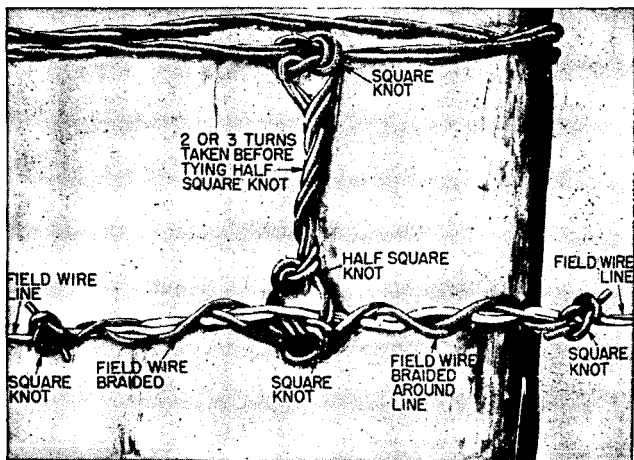

Figure 39. Variation of basket hitch tie.

ing proper sag. This becomes increasingly more important the longer the lines and the less rigid the supports. A good example of a nonrigid support is a tree. In order to gain sufficient clearance and preserve the sag necessary to allow the tree to sway, it may be necessary to attach the hitch as far up in the tree as it is safe to climb. A long span with proper sag is much better than a short, tight span between two trees. The sway of the trees will soon cause trouble in a tight line. When wire lines are to be tied to poles it is desirable to make the basket hitch tie (par. 18g) on the ground before climbing the pole. After the wire is fixed at its proper place at the top of one pole the necessary sag, between this and the next pole, is obtained as follows: stand at the bottom of the second pole, pull the conductor wires hand tight to the center of the base of that pole, measure back along the wire a distance of two feet; this marks the point where the basket weave is to be anchored. If this is to be a tie in midsection of the line, the second basket hitch will be made at the same time. This will provide ample sag in the line and allow the conductor wires to loop around the pole (see fig. 38). All lines in a given span should sag alike.

19. CIRCUIT MARKING TAGS. a. Field wire circuits are tagged to assist in recognition. Tags are marked to show the designation of the circuit (see par. 9). The tags (fig. 40) should be of some water-repellent substance that will show marks made by a soft pencil or crayon. Short pieces of soft wire, passed through the eyelets of the tags, are used to attach the tags firmly to the wire line in such a manner that they can be easily removed when the wire is recovered. Tags are required where the wire line connects to an instrument or terminal strip, and are attached about 1 foot from such equipment. Tags are placed also at frequent intervals along the wire, particularly where circuits parallel each

other for a long distance; at points where circuits leave the main route; at points where wire is buried; and at points where the type of construction changes, as from surface to overhead.

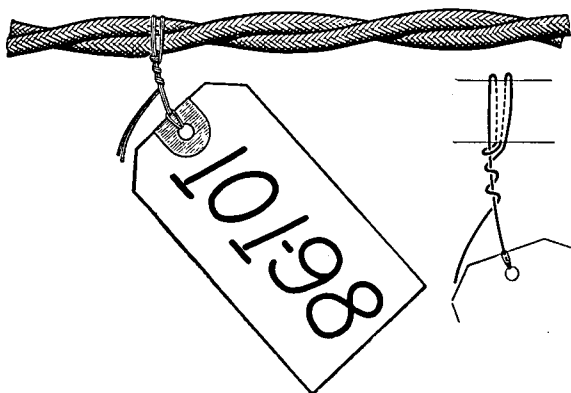

Figure 40. Circuit marking tag.

b. Trunk and long local circuits are tagged with the complete designation of the circuit. Local telephone circuits are tagged with the local telephone number. Telegraph legs are tagged with their local number and the unit to which they lead; for example, "TG-1 to 1st CT," "TG-2 to 2d CT," etc. Clear text designations of units are omitted from tags for reasons of secrecy and security. Commanders will prohibit any tagging of circuits, that would indicate to anyone unacquainted with the confidential system used, the specific units that the circuits serve. Some means of recognition such as colored tags, notched tags, tags having distinctive shapes, or a tag bearing a code number prescribed by the highest authority in the area, will be substituted. If colored tags are used, they must be identifiable at night with available light sources.

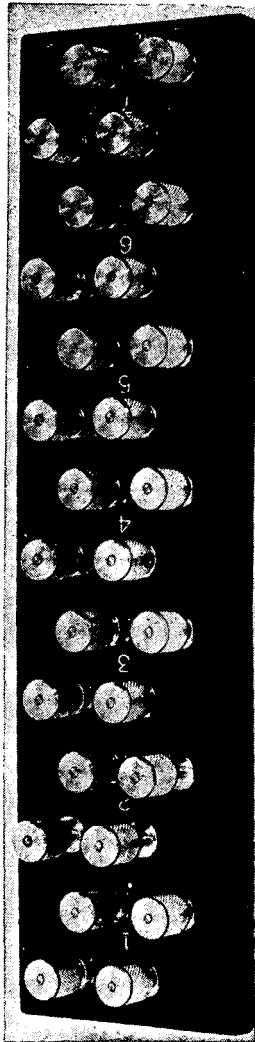

Figure 41. Terminal strip TM-184.

20. TERMINAL STRIPS. a. **Description.** A terminal strip is a block of insulating material to which are fastened several binding posts. The binding posts are connected in pairs by metal strips, so that a wire connected to a binding post on one side will be joined electrically to another wire connected to the corresponding binding post on the opposite side. The types commonly used for field wire systems are Terminal Strip TM-184, which will hold seven pairs of wires (fig. 41), and Terminal Strip TM-84-A, which will hold five pairs of wires.

b. **Connecting a wire to a terminal strip** (fig. 42). To connect a wire to a terminal strip, remove about $\frac{1}{2}$ inch of insulation from the end of the wire to be connected. Unscrew the knob on the binding post to its fullest extent. Insert the end of the wire into the slot so that the wire projects through the binding post. As an alternate method, remove about 1 inch of insulation from the wire (leaving about 1 inch of insulation on the end), double the bared portion, and insert it into the slot of the binding post. Tighten the knob firmly with the fingers, clamping the wires securely in the slot, so that a good electrical contact is secured. Do not use pliers to tighten or unscrew the knob, since this may strip the threads on the binding post.

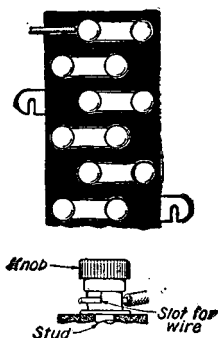

Figure 42. Wire connected to a terminal strip.

c. **Protection for terminal strips.** Terminal strips mounted in the open and subject to the effects of weather must be protected. No prescribed cover is provided. Therefore suitable wooden boxes or salvage canvas must be improvised by personnel installing the terminal strips.

21. POLE CLIMBING EQUIPMENT. a. Description.

Lineman's Equipment TE-21 for pole climbing includes a lineman's body belt with safety strap, a pair of climbers, pliers, hammer, screw driver, splicing clamp, and lag wrench. In addition, gloves and insulating tape are needed. Generally in Signal Corps units one pair of Klein climbers, type No. 1907, with 5½-inch gaffs, are issued with every 10 sets of Lineman's Equipment TE-21. This type of climber has a much longer gaff than the conventional pole climbers, and should be used when climbing large trees that have thick bark.

b. **Inspection.** Since the safety of a lineman on a pole depends in part upon the condition of his equipment, all such equipment must be inspected carefully for defects prior to its use, and any item found unsatisfactory must be replaced.

(1) *Climbers.* Climbers are examined for broken or loose gaffs and strap loops, and for defective straps and pads. The gaffs should be sharp and of the proper dimensions. Gaff Gauge TL-144 (fig. 43) is used to

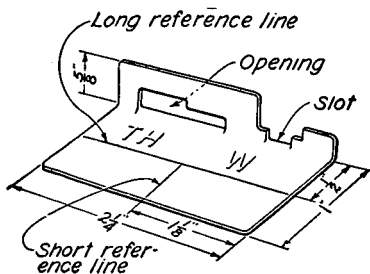

Figure 43. Gaff Gauge TL-144.

determine the important gaff dimensions as follows: the length along the inside surface; the width at distances of $\frac{1}{2}$ inch and 1 inch from the point; and the thicknesses at distances of $\frac{1}{2}$ inch and 1 inch from the point. These measurements are made as follows:

(a) *Length*. Place the gauge on the flat surface of the gaff with a short edge of the gauge held tightly against the crotch. The point of the gaff must extend to or beyond the 1 $\frac{1}{8}$ -inch short reference line at the middle of the gauge.

(b) *Width*: Place the gaff (with the flat surface next to the gauge) in the smaller of the slots marked *W*, and slide the gauge toward the crotch of the gaff as far as it will go. The point of the gaff must *not* extend beyond the long reference line, nor should it be short of this line by more than $\frac{5}{32}$ inch. Next place the gaff in the larger of the slots marked *W*, and slide the gauge toward the crotch of the gaff as far as it will go. The point of the gaff must *not* extend beyond the far edge of the gauge, nor should it be short of the edge by more than $\frac{5}{32}$ inch.

(c) *Thickness*. The thickness of the gaff is checked in the same manner as the width, using the openings marked *TH*.

(2) *Lineman's belt*. The lineman's body belt and **safety strap** are examined before use for cracks, cuts, tears, **broken** stitching, worn places, loose rivets, or other defects **that** would be likely to affect the strength of the leather. Buckles, snap hooks, keepers, and **D-rings** must be **inspected** also for defects and excessive wear.

c. **Care of equipment**. (1) *Climbers*. The gaffs of climbers must be kept sharp and free from rust at all times. Sharpening is done by clamping the climber in a vise and filing flat on the *inside* surface of the gaff, thereby retaining the original shape of the gaff. After sharpening, the gaff dimensions are checked as described in b(1) above. When climbers are not in use, they are

given a light coating of oil to prevent rust. They must not be stored in the same container with body belts and safety straps, because the sharp gaffs may damage the leather equipment.

(2) *Leather belts and straps.* The body belt, safety strap, and climber straps are kept clean, soft, and pliable by the use of saddle soap or by washing thoroughly with the lather from a neutral soap (such as castile), to remove embedded dirt and perspiration. The leather is wiped dry and oiled sparingly with neat's-foot oil. Mineral oil or grease should not be used. Personnel must not subject the leather parts to excessive heat by standing near an open fire when equipment is worn, or by hanging the belt on or near hot steam pipes. Further instruction on the care of leather may be found in AR 30-3040. These instructions do not apply to canvas body belts and safety straps, which may be issued in lieu of leather equipment.

d. Size and adjustment. (1) *Climbers.* The size of climbers is determined by the measured length, in inches, from the instep to the end of the leg iron. The correct size of climber to use is one measuring $\frac{1}{2}$ inch less, in length, than the distance from the projecting bone on the inside of the knee to the arch of the shoe of the wearer. Climbers are bent to conform to the wearer's leg so that they are comfortable. Straps are fastened snugly around the calf and ankle.

(2) *Body belt and safety strap.* On a body belt of the proper size, the D-rings will be just behind the projecting portions of the lineman's hipbones. The body belt is worn over the hips and tight enough to prevent slipping. If the lineman is right-handed, he snaps both ends of the safety strap to the left-hand D-rings; if left-handed, he snaps the ends to the right-hand ring. The double end of the strap is snapped to the D-ring, with the keeper toward the rear, and remains hooked at all times. The fixed end of the strap is snapped on the D-ring with the keeper toward the front, and the snap

hook above the snap hook of the double end. Before pole climbing is begun, the safety strap should be adjusted to the proper length. This is done in the following manner: stand at the base of the pole upon which the work is to be done, and engage the gaffs of the climbers; pass the safety strap around the pole, as described in paragraph 23d, and fasten the strap. Lean back, keeping the torso about parallel to the pole until the weight is supported by the safety strap. When the safety strap is adjusted properly, the palms of the hands will rest on the far side of the pole without overlapping.



Figure 44. Lineman with equipment, front.

22. POLE CLIMBING SAFEGUARDS. a. **On the ground.** Men wearing climbers must be careful at all times since gaffs can cause serious wounds. It is par-

ticularly important for men wearing gaffs not to step on the feet of other persons. *Climbers should be worn only while climbing and working on poles.* The habit of hearing climbers while working on the ground or riding in a vehicle will result inevitably in serious injury to personnel.

b. **Aloft.** While aloft, always use the safety strap, not only to prevent falling, but also to facilitate working with minimum fatigue. Linemen must be careful not to drop tools or other equipment while on a pole.

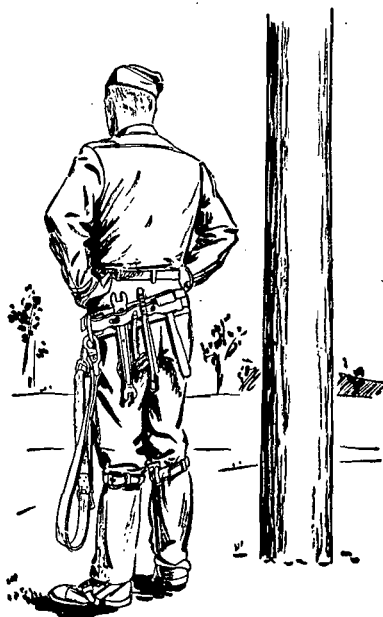

Figure 45. Lineman with equipment, rear.

c. **Testing poles.** Poles which have been in service for long periods of time may be defective, and are likely to break under unbalanced loads due to climbing or working. If a pole breaks, communication may be dis-

rupted, material destroyed, and personnel injured. The poles, therefore, should be tested prior to climbing and provided with temporary supports, if found to be defective. It is unnecessary to test an in-line or a properly guyed pole attached to a suspension strand, five power wires, a full cross arm of heavy telegraph wires, or a four-way storm-guyed pole. A suitable test for soundness can be made by applying a 16-foot pike pole at an angle of about 45° to the pole, and rocking the pole back and forth at right angles to the line. If the pole cracks or breaks, it is unsafe for climbing without temporary bracing. Such bracing can be provided by means of four pike poles, by guying to trees or other sound poles, or by support from a derrick truck. The pole also can be tested for soundness by prodding the butt just below the ground line with a screw driver or bar. This test will reveal rotten wood if the pole has commenced to decay at that point. If the butt is broken or decayed, the bottom of the pole is secured by driving bars into the ground around the pole. The pike pole test must not be applied if the pole will crush material in falling, and the pole should not be rocked so vigorously that the wires swing together and cause trouble in the circuits.

23. CLIMBING POLES. In the following, it is assumed that the lineman is right-handed. A left-handed lineman performs the operations below with the opposite hands and legs.

a. General. In climbing a pole, keep the arm slightly bent, with the hips farther from the pole than any other portion of the body. To engage the gaffs, whether ascending or descending, thrust the legs inward and downward. To disengage the gaffs, move the legs sharply upward and outward. Place the hands on the far side of the pole. If the hands overlap, the body is too close to the pole, and there is danger of the gaffs cutting out, causing a loss of footing; if the hands are

on the sides of the pole, the palms have no purchase, and the arms are under great strain. The weight of the body is carried normally and lifted entirely on the gaffs; the arms merely balance the climber. If the hips are too close to the pole, the legs will be parallel to the pole and the gaffs will cut out, removing support for the climber. If the hips are too far out, the arms are placed under strain since they will be supporting a large portion of the climber's weight. If the knees touch the pole the gaffs will lose purchase and cut out.

b. Ascending. (1) Before climbing, circle the pole and inspect it for soundness; also note the location of wide weather cracks and soft or hard spots in the wood. Observe any cables, cross arms, or other obstructions that may interfere with climbing. If the pole leans, face

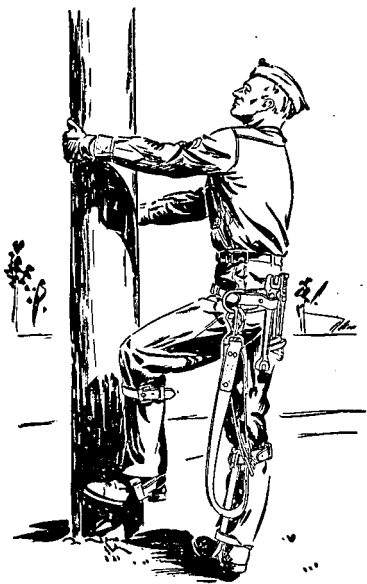

Figure 46. Beginning the climb.

the direction in which the pole is leaning and climb on the high side.

(2) Grasp the pole and raise the left foot about 10 inches from the ground, keeping the gaff about 1 inch from the pole. With a downward thrust, jab the gaff of the climber into the face of the pole at a point about 8 inches from the ground.

(3) Lift the weight of the body on the gaff by straightening the leg. While the weight of the body is on one leg, keep that knee straight and away from the pole. Raise the other leg and corresponding arm, and then drive the climber downward and inward to seat the gaff firmly (see fig. 47).

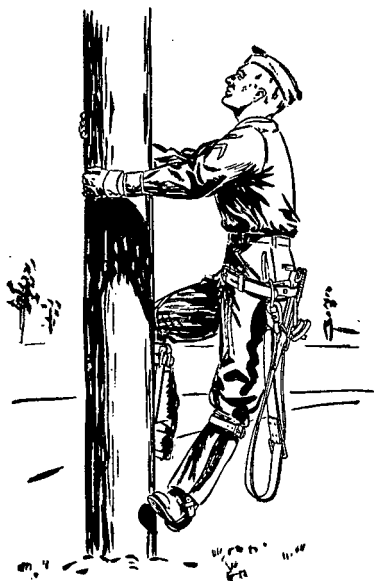

Figure 47. Climbing.

(4) The gaff is disengaged by a sharp upward and outward motion of the leg. In taking the next step,

the left leg and right arm (or vice versa) are raised together.

(5) Reengage the free gaff firmly, and continue climbing to the desired height. While ascending, always look up to see what obstructions may be in the way.

c. Descending. The motions in descending are the reverse of those in ascending. Look down to see that the way is clear below.

d. Fastening safety strap. To fasten the safety strap when the desired height on the pole has been reached proceed as follows:

(1) Shift the weight partially to the left foot, and engage the right gaff at a slightly higher level than the left gaff.

(2) Place the right hand around the pole (fig. 48)



Figure 48. Unhooking safety strap.

and, with the thumb of the left hand, open the keeper on the snaphook and shift the fixed end of the safety strap around the pole to the right hand.

(3) Transfer the snaphook and strap to the right hand, (fig. 49) and balance the body with the left hand.

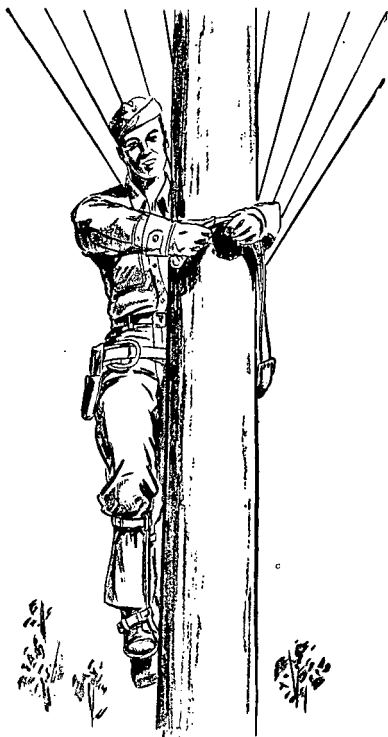

Figure 49. Transferring safety strap to right hand.

(4) Hold the strap up loosely on the pole at about the proper height, and using the right hand, pull the strap to the right-hand D-ring.

(5) Snap the hook on the right-hand D-ring, using the heel of the right hand.

Caution: It is essential to SEE that the snaphook is properly engaged. Do NOT assume, merely from the snap of the keeper, that the D-ring has been engaged by the snap hook. (See fig. 50.)

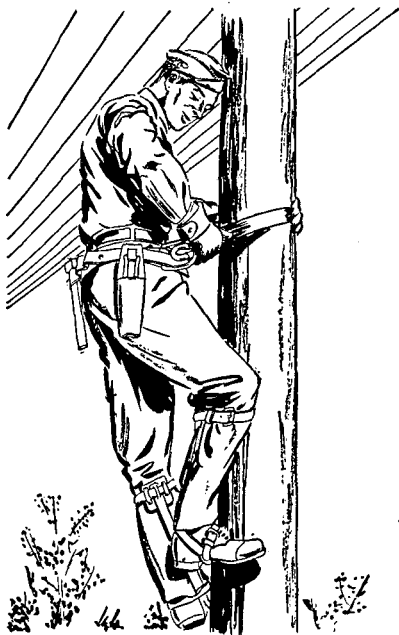

Figure 50. Snapping hook on D-ring.

(6) Reengage the right gaff at the same level as the left gaff. Then lean back and carefully place the full weight of the body on the safety strap, keeping the hands firmly gripped about the safety strap until it has been tested (see fig. 51).

e. Unfastening safety strap. To unfasten the strap, the reverse motions are carried out:

(1) Move the right gaff up and reengage it at a slightly higher level than the left gaff.

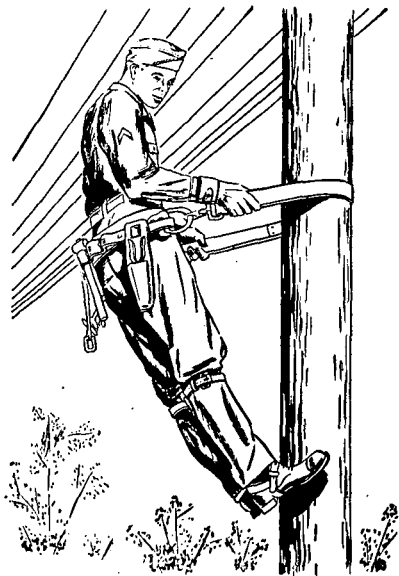

Figure 51. Testing the safety strap.

(2) Hold the pole with the left hand. With the right elbow up, the hand twisted, and the thumb held downward, depress the keeper and disengage the snaphook from the right-hand D-ring.

(3) Pass the strap around the pole to the left hand, balancing the body with the right hand.

(4) Snap the hook to the left-hand D-ring with a single downward movement.

f. Precautions. Beginners should perform these operations near the ground until sufficient practice enables them to pass the safety strap around the pole with speed and precision. Not until then should they attempt to carry out these same operations aloft. While the lineman is working at the top of the pole, the safety strap is never placed above the top cross arm nor within 6 inches of the top. If the outer wires of a cross arm are

to be reached, hook the safety strap just below the cross arm. Thrust the body between two conductors so that the head and shoulders are above the level of the cross arm (see fig. 52).



Figure 52. Working on outer wire of cross arm.

24. WIRE-LAYING EQUIPMENT. a. General. Field wire is carried forward by and laid from motor vehicles or animals carrying reel units; from hand-drawn or vehicle-towed reel carts; from reels on axles carried by hand; and from bundles or coils carried by hand. The actual method used depends upon the equipment available, the condition of the roads and terrain, the amount of traffic, and the tactical situation.

b. **Reel Cart RL-35** (fig. 53). Reel Cart RL-35 is a two-wheel cart with pneumatic tires, which may be pulled by hand or towed behind a vehicle. Each reel cart carries three Reels DR-4 or one Reel DR-5, which are removable. The axle is equipped with a detachable hand crank for use when recovering wire on the reels. Reel Cart RL-35 is particularly suitable for laying wire over terrain that is impassable to motor vehicles, such as very soft ground or heavily wooded areas. Prior to being towed behind a vehicle, the handle (draw bar) is unfastened from the lunette on the tongue and placed in a bracket at the rear of the cart. The lunette fits the pintles on certain small vehicles only.

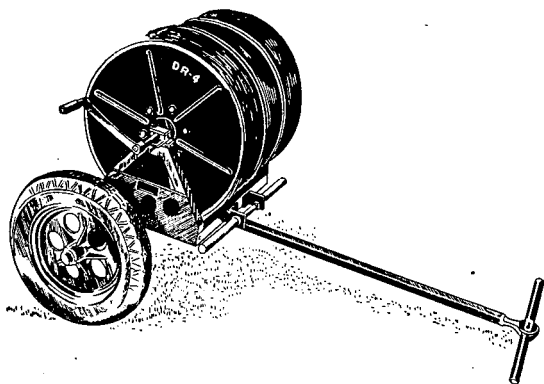

Figure 53. Reel Cart RL-35.

c. **Reel Unit RL-31** (fig. 54). (1) Reel Unit RL-31 is a lightweight portable frame designed to facilitate the reeling and unreeling of field wire and cable by hand. The reel unit contains bearings for a steel axle that is equipped with a removable hand crank. The first models of this reel unit had an automatic drag brake to prevent the reel from turning too rapidly while unreeling. The automatic brake was replaced in later

models with a hand-operated brake permanently attached to the frame. The hand-operated brake does not operate unless pressure is applied by the reel unit operator.

(2) All models of Reel Unit RL-31 can be used in the same manner. Reels DR-5, DR-7, or two DR-4's may be used with Reel Unit RL-31. However, when wire is being laid simultaneously from two Reels DR-4 both reels must contain the same amount of wire. If this precaution is not observed, the line from the reel with the greater amount of wire will have excessive slack.

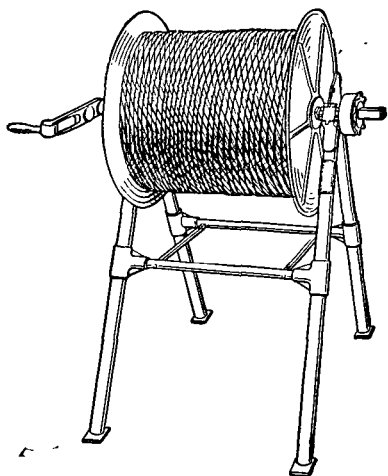

Figure 54. Reel Unit RL-31 with Reel DR-5.

(3) Reel Unit RL-31 may be set up on the ground, mounted in a vehicle, or attached to the tailboard of a vehicle. The type of vehicle on which the unit is to be mounted determines whether the four toe plates or the two tailboard hangers will be used to hold the unit securely in place. Both types of hangers are provided. A special kit of attachments is provided for mounting the reel unit on a $\frac{1}{4}$ -ton 4x4 truck. For detailed instruc-

tions on the mounting and use of Reel Unit RL-31, refer to TM 11-362.

d. **Axle RL-27** (figs. 55 and 56). Axle RL-27 is a simple form of wire-laying device for laying short local circuits by hand. It can be used to lay lines where conditions do not permit the use of other wire-laying equipment. The axle is a machined-steel bar, about 2 feet long, with two knurled handles, one of which is permanently fixed to the bar. The other handle can be removed to permit placing a Reel DR-4 on the axle. The axle is equipped with roller bearings.



Figure 55. Axle RL-27, showing removable handle.

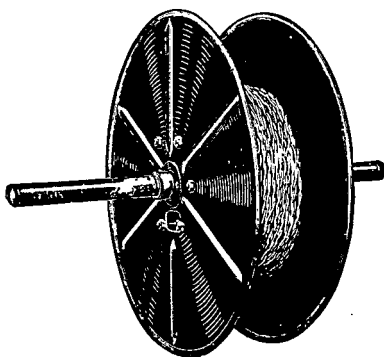
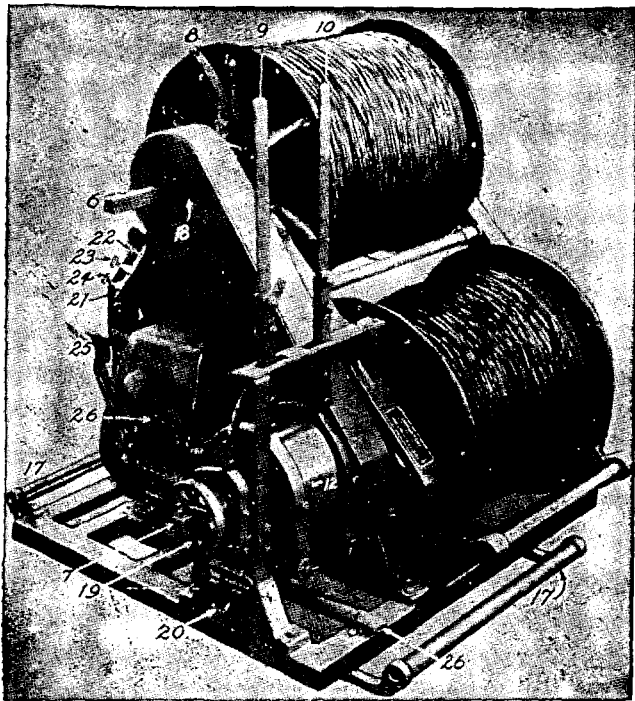

Figure 56. Axle RL-27 with Reel DR-4.

e. **Reel Unit RL-26** (fig. 57). (1) Reel Unit RL-26 is a transportable wire-laying and wire-recovering machine intended for temporary or permanent installation in motor vehicles. Reel Unit RL-26 may be operated while the vehicles are stationary or in motion. The



- | | |
|---|----------------------|
| 6 and 7. Axles for reels. | 20. Axle tools. |
| 8. Secondary clutch lever for upper axle. | 21. Control panel. |
| 9. Main clutch lever for lower axle. | 22. Ignition switch. |
| 10. Main clutch lever for upper axle. | 23. Throttle. |
| 12. Clutch drum. | 24. Choke. |
| 17. Skid frame. | 25. Pedal starter. |
| 18 and 19. Axle latches. | 26. Exhaust pipe. |

Figure 57. Reel Unit RL-26 with two Reels DR-5 in position.

unit also may be operated dismounted, in temporary stationary positions on the ground. All component parts are assembled on a skid frame which can be installed quickly in the back of a vehicle. The capacity of the unit is two Reels DR-5, mounted in position for paying out or reeling in the wire. The individual reels are readily replaceable. The wire can be payed out from either reel singly, or from both simultaneously, and means are provided for braking the reels to prevent overspinning. The small gasoline engine provides power to recover the wire on either reel individually, or on both reels simultaneously. When the engine is inoperative, wire can be recovered by hand cranking. The weight of Reel Unit RL-26, without reels, is about 346 pounds. The unit fully loaded with 2 miles of wire weighs approximately 690 pounds.

(2) The method of laying wire from Reel Unit RL-26 mounted in a 2½-ton truck is shown in figure 58. Under certain conditions, it may be desirable to mount this reel unit in a 1½-ton truck or a ¾-ton weapons carrier. More complete descriptions of the operation and maintenance of this reel unit may be found in TM 11-360.

f. Reel Equipment CE-11. Reel Equipment CE-11 is shown in figure 59. It consists of a Reel DR-8, carrying handles for the reel which incorporate the support bearings and a square-shaft axle with crank for re-winding, a sound-powered telephone Handset TS-10, and carrying straps. The method of carrying the handset shown in figure 59 permits the operator to hear a prearranged signal for attracting his attention, without the necessity of continuously holding the handset to his ear. To lay wire with this equipment, the handles are unstrapped from the carrying straps, and the reel is then carried in the hand at the side of the body allowing the reel to rotate freely. The equipment may be strapped to the back for wire laying also. To recover

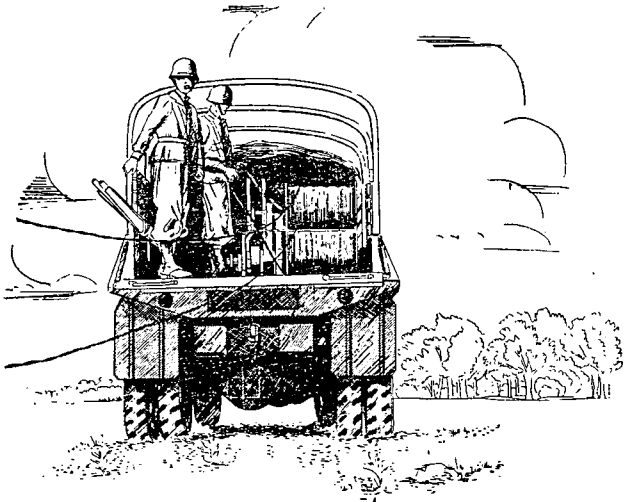

Figure 58. Laying field wire from truck-mounted Reel Unit RL-26.

wire, the carrying handles are snapped to the carrying straps, and the reel is rotated by means of the crank and axle as the operator walks toward the opposite end of the line. See TM 11-2250 for complete information on this equipment.

g. Commercial spools. Wire issued on commercial spools may be laid by inserting an iron bar through the axial opening in the spool and paying out the wire from a vehicle; or two men may carry the spool on the bar and pay out the wire while walking along the route.

h. Pack-saddle carriers. Pack-saddle carriers are available for transporting several Reels DR-4 on the back of a pack animal. Field wire may be payed out or reeled in directly from the mounted reels.

i. Maintenance of wire-laying equipment. Periodic inspection and maintenance of wire-laying equipment is essential for efficient operation. This applies to *all* wire-

laying equipment, but particularly to engine-operated reels. For details of maintenance procedure, refer to TM 11-360 and 11-362.



Figure 59. Reel Equipment CE-11.

Section II. CONSTRUCTION

25. PLANNING OF WIRE LINES. a. **General.** The planning of wire lines in any unit is the responsibility of the signal or communication officer of that unit. This planning includes the type of line to be built and the general route to be followed. The type of line is deter-

mined by considering the following primary factors: the type of equipment available, the number and quality of circuits required, the length of the line, and the time available for the installation. The quality of the proposed line may be estimated by considering the relative transmission characteristics of the different types of field wire when laid on the ground, when buried, or when installed aerially on overhead supports. Generally, aerial lines give longer transmission ranges and provide more physical protection for the circuit than other types of construction. The time element, however, may limit the use of overhead construction, in which case the wire will have to be laid hastily on the ground.

(1) The reliability of surface line construction is directly proportional to the care exercised in the installation. Field wire lines laid rapidly on the ground without regard for policing will require immediate and continuous maintenance and are seldom justified. On the other hand, surface lines laid carefully, with due consideration to ties, road crossings and other forms of protection, provide a reliable type of line suitable for most combat requirements.

(2) It may be desirable in remote instances to lay the initial wire with only a minimum of policing and then do the proper policing immediately thereafter.

(3) It must be remembered that complete and final policing of wire lines is a separate operation and should in no way affect the rate of placing the wire or delaying the obtaining of wire communication.

b. Routing. Selection of the route is based on the requirements of the tactical situation and on map study, supplemented by a ground reconnaissance. The route is planned to avoid difficult terrain, since such terrain increases the amount of special construction needed and thereby reduces speed and efficiency. Continuous liaison is maintained with all units engaged in road building and road improvement to avoid routing lines where

there is a possibility of damage to the line from road construction. If it is imperative that wire lines be laid along roads where construction work is being done, coordination must be maintained with engineer units to guard against unnecessary interruption to wire communication. Where there is possibility that the initial type of installation will require a change to a more permanent type, or where the lines may be used again by the same unit or another unit after the movement of command posts, the route should be chosen to make the change as easy as possible. Compact or built-up residential areas should be avoided wherever possible. Wire construction among buildings is difficult to install and maintain and is sometimes an invitation to sabotage in occupied territories. Cross-country routes should be used whenever practicable. They are desirable since they minimize interruptions resulting from friendly traffic, aerial bombardment, artillery fire, and mines. The construction chief is allowed considerable latitude in following the route indicated by the signal or communication officer, so that he may make changes in the event of unforeseen conditions. A reconnaissance of the route by the construction chief before the wire lines are laid is essential.

Caution: When laying wire along roads or cross-country in recently captured areas, special care must be taken to safeguard against mines and booby traps. Mine detector equipment should be used in mined areas.

c. Maintenance. When planning wire lines future maintenance problems must be given consideration. Main traffic routes, shelled areas, and areas over which tanks or tractors are likely to pass are avoided whenever practicable. In most instances, maintenance can be facilitated by using a minimum number of routes. However, a small number of routes tends to increase the vulnerability of the lines and complete interruption of wire communication may result unless each route is chosen particularly well. The route or routes chosen

should, whenever possible, provide cover from hostile observation and fire to minimize the hazard to men building or maintaining the line.

26. CONSTRUCTION ORDERS. a. The construction chief is given orders prescribing the number of circuits to be installed, the priority of installation, the time at which each of the various circuits must be completed, and the action to be taken upon the completion of the installation. The construction chief should receive or obtain the following descriptive information about each circuit to be laid:

- (1) Circuit number.
- (2) Route.
- (3) Whether a trunk or a local circuit.
- (4) Whether a metallic or a ground return circuit.
- (5) Type of wire.
- (6) Switching centrals the circuit will connect, and test stations through which it will pass (including the telephone directory names of the organizations served).
- (7) Approximate length.
- (8) Type of construction.
- (9) Nature of roads and terrain.
- (10) Precautions to avoid damage by friendly troops and transportation.
- (11) Tests and reports required.

b. The information in a above is best provided by a line route map and circuit diagram, supplemented by oral or written instructions from the signal or communication officer. These instructions always include orders as to the disposition of the construction detail after the construction specified has been completed.

27. CONSTRUCTION CENTER. a. Construction centers are installations located near or in a command post area where trunk and long local wire lines con-

verge for entrance to the telephone central. Crews can be dispatched from this point by the construction chief or wire chief, thus eliminating unnecessary traffic in the command post area. Construction centers should be located at some distance, usually several hundred yards, from the command post switchboard. Testing equipment is installed at construction centers in order that maintenance personnel may terminate and test wire lines under construction, make routine tests on working lines, and make fault-locating tests on lines that are in trouble. These tests can be made at the construction center without interfering with the switchboard operators. At corps and higher headquarters it may be desirable, depending upon local circumstances, to have all testing equipment located nearer the command post switchboard, in which case the construction center may become only a test station.

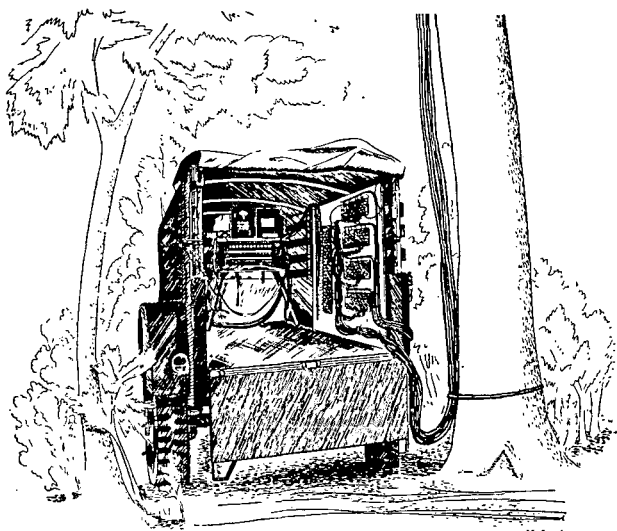

Figure 60. Suggested equipment lay-out for a construction center.

b. The amount of equipment at a construction center may range from a terminal strip and telephone with test leads to a terminal frame, a test switchboard, and one or more test sets. Standard equipment only should be used for establishing a construction center. It should be installed in such a way that it can be removed or disassembled readily. Figure 60 shows the equipment layout for a construction center and associated test equipment installed in a 1-ton trailer. Figure 61 is a suggested wiring diagram for this construction center which uses Switchboard BD-72 as a test switchboard.

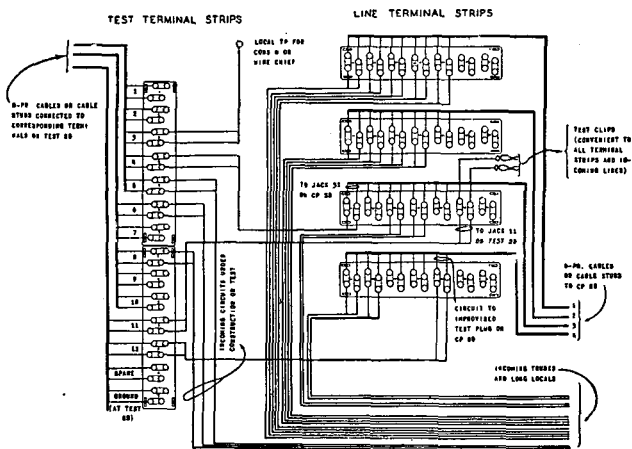

Figure 61. Suggested wiring diagram for a construction center.

c. With this construction center installation, all trunk and long local circuits are terminated at the test terminal strips when they are laid. After being tested, they are transferred from the test terminal strips to the line terminal strips where field cables from the command post switchboard are terminated. It is not necessary to have a test switchboard with sufficient drops for

all lines coming into the command post. In figure 61, drop 4 of the test Switchboard BD-72 is used for a talking circuit to the command post switchboard, drop 3 is used for a local telephone, drop 11 is terminated in test clips for the purpose of monitoring circuits while in operation, drop 12 terminates in an improvised test plug at the command post switchboard and is used for testing local lines that are not connected through the construction center. Lines 1 and 2 are equipped with repeating coils and are reserved for testing directly on simple and phantom circuits, if this becomes necessary. The remaining six drops are terminated at the test terminal strips, thus providing facilities for six lines under test or construction to be connected to the test switchboard at the same time. The test man can answer calls from trouble shooters or crew chiefs on any of the six lines and can test each one individually with his testing equipment when required. Circuits are terminated in the test switchboard only for initial testing or when in trouble. Test terminal strips shown in figure 61 are used merely as a convenience and may be eliminated by connecting lines directly into the test Switchboard BD-72.

d. Records of connections made on the terminal frame of the command post switchboard are kept at the construction center. If a circuit develops trouble, it is tested in the following manner: when the operator reports trouble on a circuit, the test man connects the test leads (which terminate at jack 11 of the test switchboard) to the terminals of the circuit reported in trouble. The line now appears directly on the test switchboard, allowing the test man to make preliminary ringing and talking tests to determine whether the trouble is in the line or toward the command post switchboard. Assuming that line trouble is indicated, the test man will refer to his records to determine if the line in trouble has simplex, phantom, or other superimposed facilities, he will call

the location where the facilities terminate and determine whether they are working. Permission to interrupt working superimposed facilities must be obtained. He then removes the line wires from the line terminal strip and places them on a vacant pair on the test terminal strips. Test equipment will be equipped with cords and plugs to allow connections to be made to any jack of the test switchboard. The complete test circuit may be established now from the test set through the cord and plug and the test switchboard. The type of test set used determines the extent and accuracy of the tests that can be made.

28. PROCEDURE IN LAYING FIELD WIRE. a.

Before starting the construction, the construction chief makes a personal reconnaissance of available routes. During this reconnaissance the following features of the routes are noted:

- (1) Number of overhead crossings.
- (2) Number of underground crossings.
- (3) Number of railroad crossings.
- (4) Number of stream crossings.
- (5) Type of terrain, and the type of construction best adapted to available wire-laying equipment.
- (6) Distances in miles.
- (7) Concealment for wire parties during construction and subsequent maintenance.
- (8) Any obstacles to maintenance.
- (9) Alternate routes to avoid gassed, shelled, or mined areas, or other unfavorable conditions.

b. The next step is to select and mark clearly on a map the exact route along which the wire is to be laid. The route selected is the one that meets the requirements of the tactical situation and offers the least difficulty to construction and maintenance.

c. The wire for the circuits is tested before starting, to insure the continuity of each reel. Reels of wire that

do not show a continuous circuit when tested are not used until the wire has been serviced (see par. 86).

d. At the starting point, the free end of the wire is tagged with the circuit designation (see par. 19). This tag is placed a foot from the end of the wire.

e. Enough wire is left at the free end to reach the switchboard terminal strip or other installation, and the wire is tied in to some fixed object.

f. The free end of the wire is connected to the construction center terminal strip, if installed, or to the switchboard terminal strip or to a Telephone EE-8().

g. The construction chief determines the detailed route (b above) and directs the laying of wire. The general route prescribed by the signal or communication officer is followed (see par. 25). After each splice is completed, a test is made back to the starting point from the far side of the splice in order to insure continuity of the circuit. Test clip pinholes are undesirable in the wire insulation and may be avoided by making this test on the bare wires from the far side of the splice before taping is started. Precaution must be exercised so as not to induce trouble during the taping process. When connections are made at terminal strips, a test is made from the far side of the connection back to the starting point.

h. When the wire has been laid to the designated point, it is tied in and tagged. The free end is left with sufficient slack to run to the switchboard terminal strip. The circuit is then tested and turned over to the operating detail, who connects it to the switchboard terminal strip or to an instrument. The construction chief calls back over the completed circuit to report the installation. This call is placed through the switchboard, or other instrument, if installed, so that any fault in the terminal connections may be discovered and corrected before the circuit is reported.

i. Should the wire be laid to any locations where a

switching central is to be installed, but where the operating detail or the equipment for the installation has not yet arrived, the construction chief calls back over the circuit in order to verify that he is at the right location and to ask for instructions. In the absence of other instructions, the construction chief leaves a member of the construction detail at the wire terminal with a telephone connected to one circuit. This man informs the arriving personnel of the location of the circuits, and assists in making the terminal connections. After the terminal apparatus has been connected, he makes a test back and reports over each circuit. Sufficient slack is left at these terminals to permit extending the circuits to the probable location of the telephone central.

29. TEST POINTS. Test points are locations along a wire line from which circuit tests can be made conveniently. Usually they are chosen arbitrarily by maintenance personnel and are not necessarily prearranged locations equipped with terminal strips.

30. TEST STATIONS. Test stations may be installed on a wire line to facilitate the testing and rearranging of circuits. They may be located at points where circuits diverge, at the end of a wire line that does not terminate in a switchboard, near points where circuits are most exposed to damage, at probable future locations of command posts, or at other convenient points on the line. If a command post is established where a test station has been installed previously the test station can be converted easily into a telephone central. Usually test stations are given a geographic designation; for example, Jones Farm Test.

31. CONSTRUCTION AND REMOVAL OF TEST STATIONS. a. **Construction.** The site selected for a test station should afford cover from hostile observation

and fire, and protection from friendly troop movements. It should be readily accessible for testing. A test station consists of one or more terminal strips fastened to a support, such as a tree or fence post. The wire circuits are tagged and tied in before being connected to the binding posts. When two circuits are connected together at a test station, they are attached to corresponding binding posts on opposite sides of the terminal strip (see fig. 62). Paired circuits are connected beginning at the top of the terminal strip. A telephone or other suitable instrument may be connected to the designated test cir-

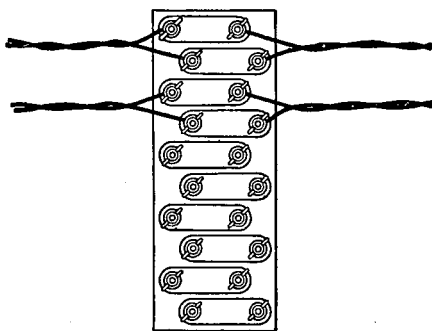

Figure 62. Test station constructed during initial installation of wire lines.

cuit as prescribed in paragraph 85. A test station may be installed after initial installation of wire lines without interrupting any conversation on the circuit. This is done by the following steps: pull in the desired slack and tie in near the terminal strip; strip the insulation from each wire to permit connections to binding posts on opposite sides of the terminal strip (see fig. 63). Other circuits are cut in to the test point terminal strip in the same manner. The circuits are cut in (in numerical order) beginning at the top with the lowest numbered circuit.

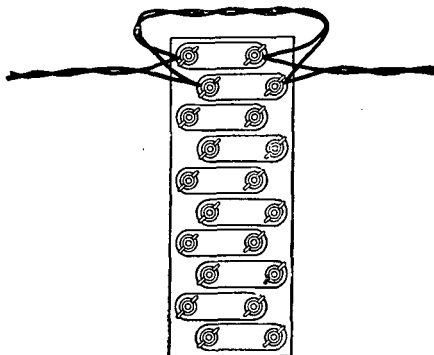
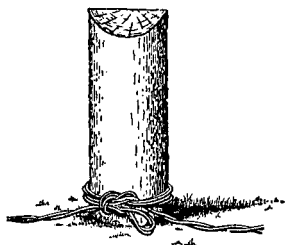

Figure 63. Test station constructed after initial installation of wire lines.

b. **Removal.** When a test station is to be abandoned, the usual practice is to leave the terminal strip connected, although it may be removed and the circuits spliced through. Before removing any circuit from the strip, the lineman first listens in on the circuit and satisfies himself that it is not in use. He then calls on the circuit and notifies the switchboard operator that the test station is to be removed and the circuits spliced through. When this has been done, the lineman takes two wires that are connected together by the terminal strip, removes them from the binding posts, and splices them together. The other wires of the pair are then spliced. The other circuits are removed from the strip and spliced in a like manner. As the work on any circuit is completed check it in the same manner as for other splices.

32. SURFACE LINE CONSTRUCTION. a. **General.** During movement of units in combat, field wire lines are laid hastily on the ground. This type of wire line is termed a *surface line*. Surface lines must be protected from traffic at command posts, road and railroad crossings, or other places where they cross traffic lanes (see

par. 46d). It must be constantly borne in mind that the *insulation of field wire will not protect the wire against damage by vehicles*. Surface lines are laid very loosely by leaving abundant, well-distributed slack. The purposes of slack are to enable the wire to lie flat on the ground, to provide incidental protection from shell fire, to facilitate the repairing of breaks, and subsequent changes in the type of construction. At suitable intervals, surface lines are tied in to objects such as trees or posts. This not only helps to leave sufficient slack, but also prevents passing troops and vehicles from pulling the wire into traffic lanes. Such ties to trees or posts are made at ground level (see fig. 64). When surface lines are routed along a road, the wires *must* be kept



(1) *Correct.*

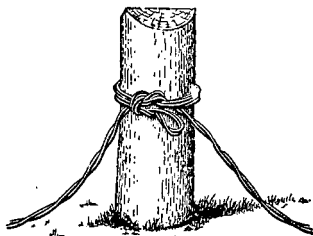

(2) *Incorrect.*

Figure 64. Method of tying wire with a square knot tie at ground level.

well off the traffic lane. If the road curves and it is practicable to do so, the line should be routed along the inside edge of the road; otherwise, it becomes necessary to make many ties on the outside edge. (See fig. 65.)

b. Connections between surface lines and pole lines. Connections between surface lines and pole lines are made most conveniently at established terminals or test stations. Whenever such connections are made, the surface line must be tied securely and tagged at the base

of the pole at which the connection is made, and tied again just above the cross arm or terminal where the lines connect. Connections to aerial or buried cables are made only at standard cable terminals.

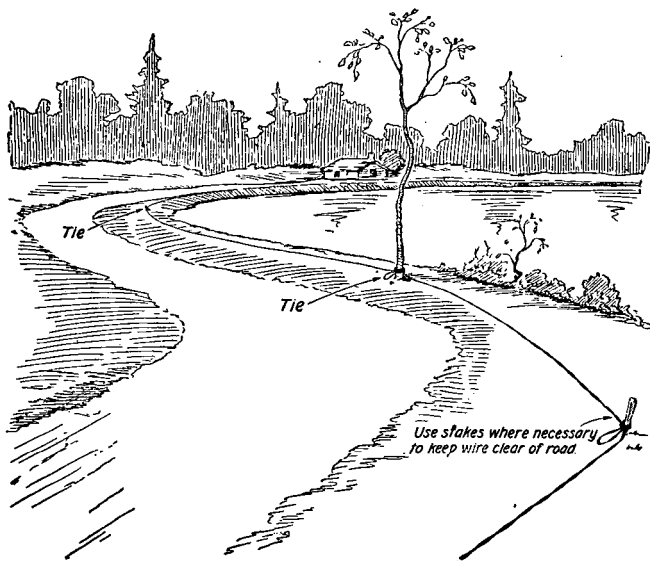

Figure 65. Method of tying wire along curve in road.

c. Advantage. The principal advantages of surface lines are:

- (1) They require minimum time for installation.
- (2) When loosely laid, they are less vulnerable to artillery fire than other types of construction.

d. Disadvantages. The main disadvantages of surface lines are:

- (1) They may become unserviceable in wet weather as a result of leakage to ground.
- (2) They often are broken by passing troops and vehicles.

33. OVERHEAD CONSTRUCTION. a. **General.** Field wire lines should be placed overhead near command posts, congested troop areas, along roadways at points where traffic is likely to be diverted from the road, and at main and secondary road crossings where no practical surface method is available (see par. 34). Trees and existing poles are the most desirable supporting structures, and should be used whenever they are available. Standard field wire ties (par. 18) are used to attach the wires. The type of tie used depends on span lengths and local climatic conditions. At junctions between overhead and surface line construction, the wires are tied securely to the bottom of the support and tagged (see fig. 66). In general test stations should be installed at junctions of long overhead lines with other types of

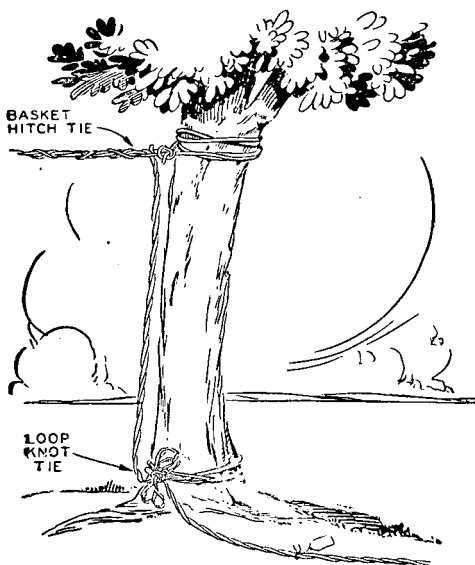

Figure 66. Method of tying wire at junction of surface line with overhead construction.

construction. When field wire is placed on commercial or other poles carrying bare wire on cross arms or brackets, it should be placed below the lowest bare wire. Field wire should never be placed so that it will swing into or come in contact with bare wire.

b. Lance pole construction. (1) *General.* Lance poles provide a convenient method for supporting field wire lines where trees, telephone poles, or other similar supports are not available. Lance Pole PO-2 is made of wood, is 14 feet long and about 2 inches in diameter. The bottom end is tapered to give the pole a good bearing in the earth, and a galvanized-iron insulator pin, threaded to receive Insulators IN-12, IN-15, IN-25, IN-26, IN-62, and IN-63, is attached to the top.

(2) *Construction at secondary road crossings.* For an overhead wire crossing on a secondary road, two lance poles can be erected as shown in figure 67. Unless the shoulders of the road are higher than the crown, the minimum clearance of 14 feet cannot be obtained and the lance poles must be lashed as explained in (3) below.

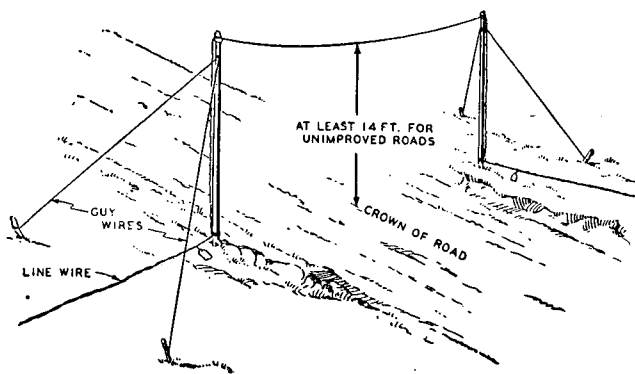
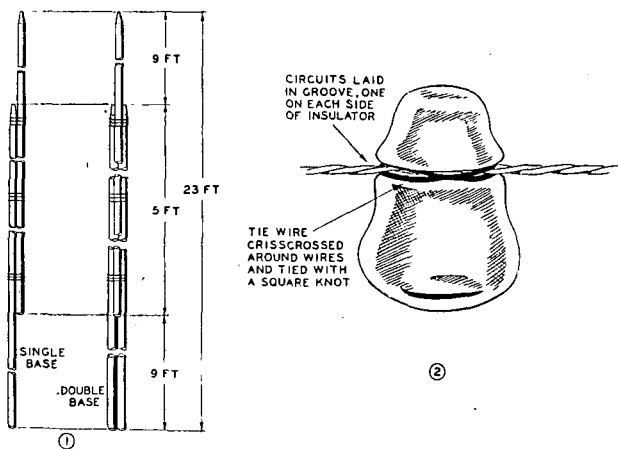

Figure 67. Crossing secondary road using lance poles.

(3) *Construction at main road crossings.* For a wire crossing over a main road, one lance pole will not provide the necessary clearance of 18 feet. To gain additional height, two lance poles may be lashed together with a minimum overlap of 5 feet. If additional strength is required, two base poles may be used (fig. 68①). The lashing should be made with salvaged field wire or marline. From one to four pairs of field wire may be attached to these lance poles without overloading the poles, provided care has been taken in the construction of the line. A more sturdy type of construction will be desirable where the situation demands that more than four circuits cross a road or where a long span is necessary. Under these conditions, follow the detailed instructions given in TM 11-369 for overhead construction using 4 x 4 sawed lumber.



(1) *Lashing lance poles.* (2) *Insulator tie.*

Figure 68.

(4) *Tying.* When insulators are used on the lance poles and climatic conditions will not affect the insulation on the field wire, the clove hitch tie may be used

to attach the line wires to the insulators. A crisscross type of tie (fig. 68②) is recommended when climatic conditions will affect the insulation and when the line can be expected to remain in place for some time. This tie is made by passing a piece of salvage field wire under the line wire, crossing up over the line and around the insulator, then down over the line to the starting point and terminate in a square knot. Single-groove and double-groove insulators can accommodate two and four field wire circuits, respectively, when tied in this manner. All circuits are separated on the insulator with this method, thus preventing a cross between pairs. If insulators are not available for use with the lance poles, the wire should be tied to the pole by means of a clove-hitch tie. Each line wire is tied separately, in the same relative position on each pole. A few inches of added height necessary for minimum clearance may be obtained by tying the line wires to the galvanized-iron tip when insulators are not available and when one or two circuits are being installed. However, this tip must first be wrapped with two layers of friction tape to prevent the threads from cutting through the wire insulation. The line and guy wire must be tied to the poles while they are lying on the ground, regardless of what type of tie is used. The poles with the wires attached are then erected and guyed in place.

(5) *Guying*. Lance poles require more guying than any other type of overhead construction. Where possible, lance poles should be lashed to solid posts or stumps. If there are no supports of this kind available, every lance pole must be side-guyed on both sides of the line, with the exception of corner poles where only one guy, placed so that it bisects the angle of the corner resisting the pull, is needed to hold the pole erect. Salvage lengths of field wire make the most suitable material for guy wires. Generally a piece approximately 40 feet long tied in the center, with a clove hitch near

the top of the lance pole, will be long enough. The guy wires are tied to stakes or other suitable supports, placed so that the guy will extend out at an angle of approximately 45° . It is undesirable to use supported field wire line circuits to guy the poles, as this puts unnecessary strain on the wires and increases the possibility of trouble in the line.

(6) *Construction of straight sections of line.* When it is necessary to install field wire lines on lance poles in a straight line, the span lengths should not exceed 100 feet, and every tenth pole should be guyed four ways. This will prevent the entire line from falling if any of the other poles are knocked down. If wind storms, snow, or sleet are expected, the distances between poles should be reduced.

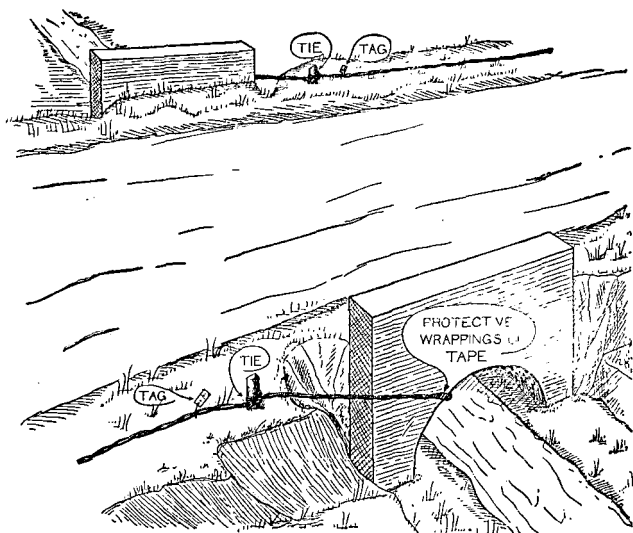

Figure 69. Wire crossing road through culvert.

34. ROAD CROSSING. a. Where a road crossing is necessary, field wire lines should cross through a culvert, if possible. The wires are passed through the culvert, tagged, and tied at the entrance and exit to prevent contact with water (see fig. 69). Especial care should be taken during floods. If the wires touch the edge of the culvert, the wires should be wrapped at the point of contact to prevent damage to the insulation.

b. Wires that cross roads overhead (fig. 70) must clear the crown of main traffic arteries and paved roads by at least 18 feet, and of other roads by at least 14 feet. When a surface line crosses a road on poles or other objects, the wire is tied at the base and at the top of the object on each side of the road, and is tagged at the base. The strain which occurs along the line is carried by the tie at the base.

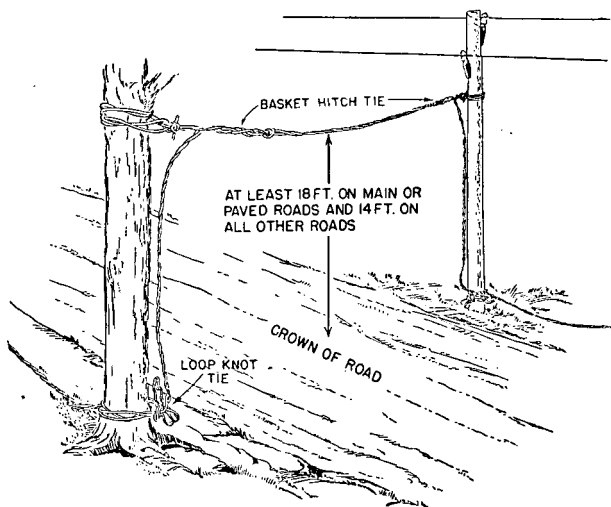

Figure 70. Wire crossing road overhead.

c. If neither of the preceding methods can be used, the wires are buried in a trench (fig. 71) which crosses the road at a right angle. The wires are laid snug, tagged, and tied to a stake at each end of the trench to prevent their being pulled out. A sufficient amount of slack wire is left at one side of the road to permit replacement of the section under the road, should it become worn or water-soaked. *The trench should never be less than 6 inches deep; in crossing poor roads which carry heavy traffic, it should be at least 12 inches deep.*

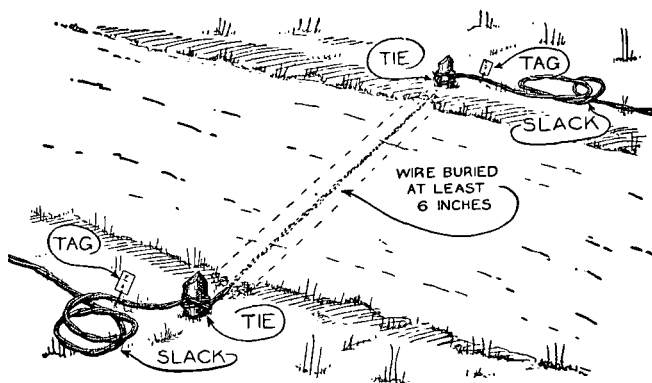

Figure 71. Wire crossing under road in trench.

d. Where a hard-surfaced road *must* be crossed and none of the above methods is applicable, then, *as a last resort*, the wire must be laid on the road. When this emergency method is used, the problem of protecting the wire is primarily to reduce the risks involved.

- (1) The smoothest section of road available should be selected.
- (2) Substitute a length of twisted wire for *each* side of the circuit crossing the road. Sometimes this is referred to as "laddering."

- (3) The wire should be laid *without slack*, and tied and tagged on each side of the road surface.
- (4) These parallel crossings should be separated by a distance greater than the length of the longest vehicle that will use the road.
- (5) Keep an exact record of this type of crossing and inspect frequently.
- (6) It may be necessary to use two twisted pairs for each side of the line. In this case each of the four pairs of wires cross the road at different points.

35. RAILROAD CROSSINGS. Railroad yards should be avoided. If a bridge or culvert is available, it should be used in making the crossing, even if this requires laying the wire parallel to the tracks for some distance in order to reach it. If a bridge or culvert is not available, field wire lines should cross railroad tracks *under* the rails (see fig. 72). In making the crossing, the wires are pulled tight and are buried outside the rails to a point beyond the shoulders or improved strip along the tracks; then they are secured on both sides to prevent them from being pulled out and becoming a hazard to trainmen walking along the tracks. Field wire lines should *never cross railroads overhead* because overhead lines endanger trainmen on top of railroad cars.



Figure 72. Wire crossing under railroad track.

36. RIVER CROSSINGS. a. **Overhead.** Small stream crossings are made in the same manner as overhead road crossings, except that the wires need be only high enough to clear the waterborne traffic. A span of more than 150

feet should not contain a splice. Long spans up to 250 feet can be made with field wire, but special construction is necessary for resisting the strain (see par. 33b(3)).

b. Submerged. When field wire lines must cross bodies of water, such as rivers, where it is impracticable to make overhead crossings, the wire should be submerged. The wire is tied in securely on the near bank, laid by paying out from a reel or coil, and tied in securely on the far bank. The ties are made above the highest level reached by the water. The insulation on the wire should be sound. Splices should be made only if absolutely necessary, and should be made as waterproof as possible. If the current in the stream is strong, or if the stream is navigable, the wire is weighted at suitable intervals to keep it submerged on the bottom of the stream and to retard its movement by the current. The amount of wire necessary for the crossing is computed carefully, and the wire is prepared in advance so as to avoid splicing the wire in midstream.

37. TRENCH LINE CONSTRUCTION. a. General. Often in position defense, field wire lines are installed in trenches. Generally two kinds of trenches are used: wire trenches constructed specifically for that purpose; and those primarily intended for other purposes, such as trenches for fire or communication. Trench wire lines are tagged at intervals of not more than 150 feet, and at junctions with other lines.

b. Wire trenches (fig. 73). (1) Wire trenches vary in size from 10 inches wide by 10 inches deep, to 36 inches wide by 30 inches deep. They afford considerable protection from shell fire, but offer an obstacle to friendly traffic. The wire may be fastened to cross arms, which are attached horizontally to short poles or rest against or project into the sides of the trench. Another method used is to fasten the wire to the sides of vertical poles.

Field wire may be tied directly to these supports with wire or marline, but it is preferable to tie the wire to wooden or porcelain knobs or insulators.

(2) The wire trench route should be chosen with a view to concealment, cover, and ease of construction. The number of trenches is kept to a minimum, and the wire is kept in the main trunk line trenches as much as practicable. Switching centrals may be installed at important trench junctions.

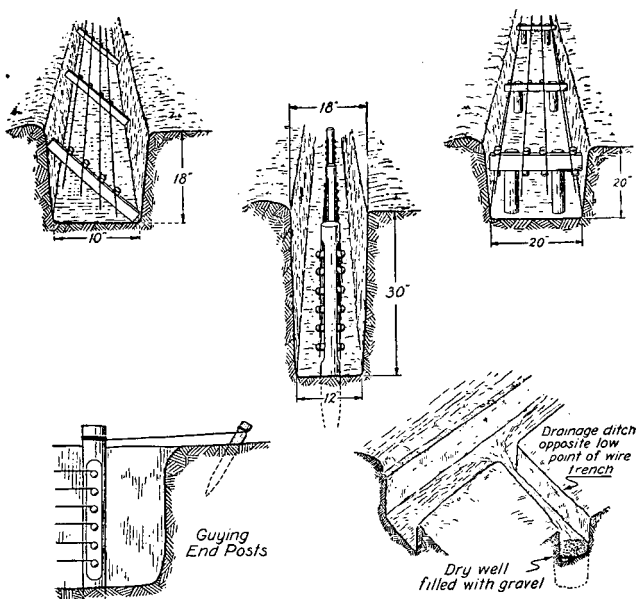

Figure 73. Wire trench construction.

c. Fire or communication trenches (fig. 74). (1) When it is impracticable to construct wire trenches, field wire may be installed temporarily in fire or communication trenches. Because these trenches are used extensively by

combat troops, they are not satisfactory for permanent wire installations.

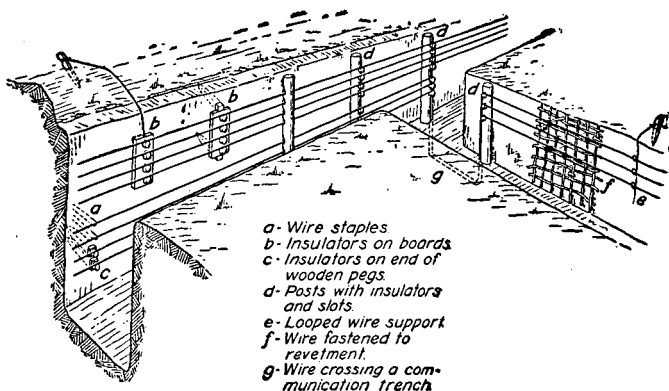

Figure 74. Wire line construction in communication trenches.

(2) Except in narrow fire trenches, wire lines ordinarily should be kept on the side of the trench nearer the enemy. Wire placed at heights between 10 inches and 30 inches from the duckboards, or bottom, of the trench is least subject to damage from cave-ins, water, and traffic.

38. USE OF CABLES AT TERMINALS. At command posts of higher headquarters, and in other areas where there is a tendency for wire communication lines to become congested, Cable Assemblies CC-345 (5-pair) and CC-355-A (10-pair) may be used to reduce the time of installation and to consolidate overhead circuits in one or more cables. For additional data and details of construction, testing, and splicing, see TM 11-371.

39. LOADING OF FIELD WIRE LINES. a. Purpose. Telephone transmission over long field wire cir-

uits can be improved by the use of loading coils to add inductance to the line and thereby counteract the capacitance of the wire. Such coils increase the maximum length of line over which satisfactory transmission can be obtained by 50 to 300 percent, depending upon the type of loading and spacing used. Lines less than 10 miles in length are usually satisfactory without the use of the coils.

b. Description of Coil C-114 (loading). Coil C-114 has an inductance of 88 millihenries and weighs about $1\frac{1}{2}$ pounds. It is equipped with a rubber gasket, hinged cover, and four binding posts. When the cover is closed, a latch on the case locks it in place (see fig. 75).

c. Spacing. The loading coils are designed to be installed at intervals of 1 mile in Wire W-110-B, and every $\frac{3}{8}$ mile in Wire W-143. The distance between one terminal of a circuit and the first coil, or the distance between the other terminal and the last coil, is known as an *end section*. The length of this section must be at least 0.2 mile and not more than 1 mile. The spacing

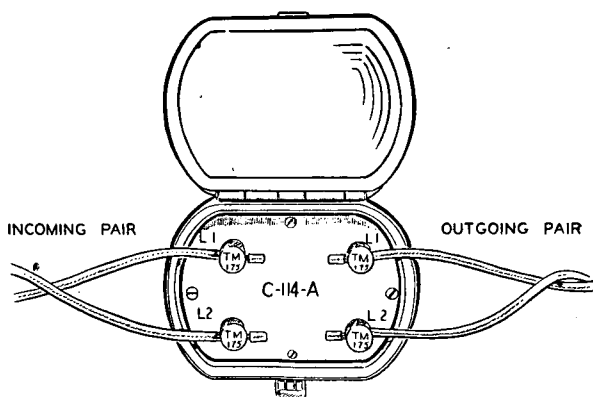

Figure 75. Method of connecting Coil C-114 in field wire line.

of the coils between the end sections should not deviate more than 5 percent from 1 mile.

d. Installation. (1) *Field wire.* The coil is installed in a field wire circuit by connecting the field wire from one direction to the two adjacent binding posts marked L_1 and L_2 at one end of the coil, and the field wire from the other direction to the two remaining binding posts marked in a similar manner. The wires should be skinned when making these connections to the terminals. All four wires must fit snugly into the grooves in the rubber gasket when the cover is closed. The strain should be taken off the coil connections by tying the line wires to a nearby post or tree in order to avoid damage to the coil or having the connections pulled out.

Caution: Coil C-114 is not watertight and should never be placed under water.

(2) *Wire W-143.* When connecting Wire W-143 to Coil C-114, remove about 4 inches of the outer cover (as described for making the standard splice, par. 15e). Do not split the two conductors at this time. With a piece of rubber tape, make a complete wrap around the rubber-insulated wires flush with the fiber outer cover (see fig. 76①). Extend the rubber tape for about 1 inch and then split the two wires, bending each one at a right angle. Continue to wrap the rubber tape on one of the wires (see fig. 76②). Reverse and tape back over the crotch and out the other wire as shown in figure 76③. Reverse again and terminate the wrapping at the original starting point. Cover the rubber tape with a layer of friction tape in the same manner, except that the starting point should be on the fiber insulation of the wire. Skin the ends of the wires and form them for connection to the coil terminals in the same manner as for field wire. For the complete tape serving, see figure 76④. This method of taping is necessary to prevent the seepage of water between the conductors when they are separated.

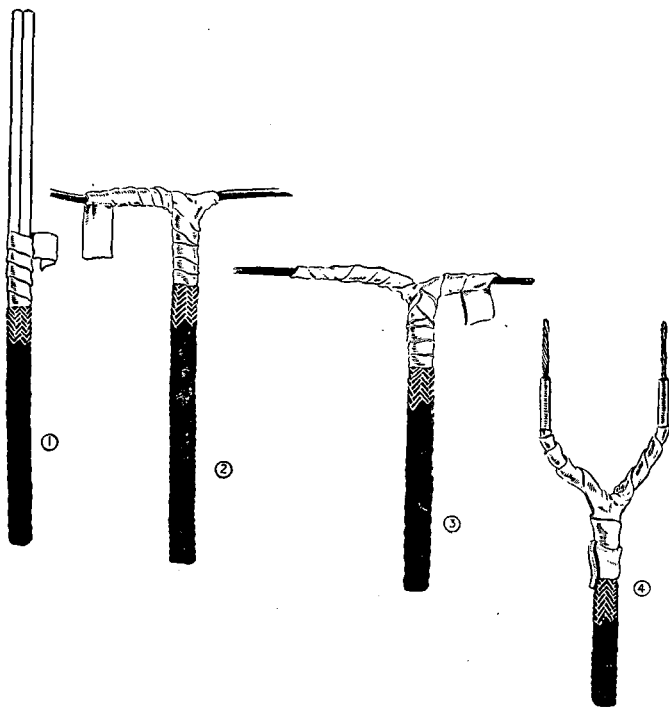

Figure 76. Method of taping Wire W-143 for connection to Coil C-114.

40. RECOVERING FIELD WIRE. a. Field wire is recovered for reuse whenever possible. This is important not only as an economy measure, but because recovered field wire constitutes a source of wire supply. To insure a wire reserve, field wire should be recovered as soon as practicable, repaired and tested, and placed in condition for future use.

b. In the recovery of wire, the recovering equipment should be preceded by linemen, who remove all tags, and who place the wire back in the path of the recovering

equipment, using either wire pikes or their hands. Ordinarily leather gloves or pads should be used for protection while handling field wire. The normal way to recover wire is to proceed along the line and wind up the wire en route. Under some conditions, it may be necessary to leave the recovering equipment stationary and drag in the wire by turning the reel. This causes more wear on the insulation, and may cause the wire to break.

c. Wire is never recovered without authority of the next higher headquarters.

CHAPTER 3

FIELD TELEPHONES AND TELEPHONE CENTRALS

Section I. INSTALLATION

41. TELEPHONE CAPABILITIES. a. Advantages and disadvantages. The greatest advantage of the telephone is that it affords immediate personal contact between individuals. Disadvantages of the telephone are the lack of a record of the conversation unless a recording device is used, and the fact that it encourages a tendency to talk too long.

b. Factors determining efficiency. The efficiency of the telephone system depends upon a number of factors, the most important of which are:

- (1) Type of wire line construction.
- (2) Type of equipment used.
- (3) Weather.
- (4) Training of the personnel operating and using the system.

c. Talking range. The distance over which satisfactory telephone communication is possible is determined by the electrical characteristics of the telephone circuit. A given type of wire circuit, under normal conditions, has a definite talking range.

d. Unfavorable conditions. The following conditions tend to decrease the efficiency of telephone circuits and the range of telephone communication:

- (1) Snow, ice, rain, heavy dew, or fog.
- (2) Poor electrical insulation between wires and ground.
- (3) Moisture in the telephone instrument, especially in the transmitter.
- (4) Weak dry batteries in local battery (magneto) telephones.
- (5) Additional telephones bridged across a circuit.
- (6) Additional switchboards involved in a connection.

42. TELEPHONE CENTRALS AT COMMAND POSTS. A telephone central is established at each echelon of a headquarters where two or more local telephones are installed. The purpose of such a central is to make possible flexible intercommunication between local telephones, and to provide connections to trunk circuits leading to other units.

43. TELEPHONE CENTRALS OTHER THAN THOSE AT COMMAND POSTS. A telephone central is installed at a point other than an echelon of a headquarters, principally for the purpose of trunk switching. Judicious use of such telephone centrals makes it possible to furnish better telephone service with the same number of trunks. On the other hand, the telephone centrals require additional personnel and equipment; necessitate an additional switching operation, thus increasing the possibility of interruptions to service; and introduce additional transmission losses.

44. TYPES OF FIELD TELEPHONES. a. **Telephones EE-8-A and EE-8-B.** Field Telephones EE-8-A, and EE-8-B can be used on either local battery or common battery systems, and have other applications which are described in TM 11-333. The two Batteries BA-30 required for each instrument are not supplied as part of the telephone, but must be requisitioned separately. An

external 3-volt battery may be used instead of the two Batteries BA-30, provided it is connected to the external battery binding posts and the internal batteries are removed. A view of Telephone EE-8-A, with the case opened is shown in figure 77. The handset and cord fit into the case when the instrument is not in service. The only difference between Telephone EE-8-A and Telephone EE-8-B is that a short steel chassis and Generator GN-38-A or GN-38-B are used in Telephone EE-8-B, instead of an aluminum alloy chassis and Generator GN-38 which are used in Telephone EE-8-A.

b. **Telephone EE-8.** Field Telephone EE-8 operates on local or common battery circuits, and is similar to

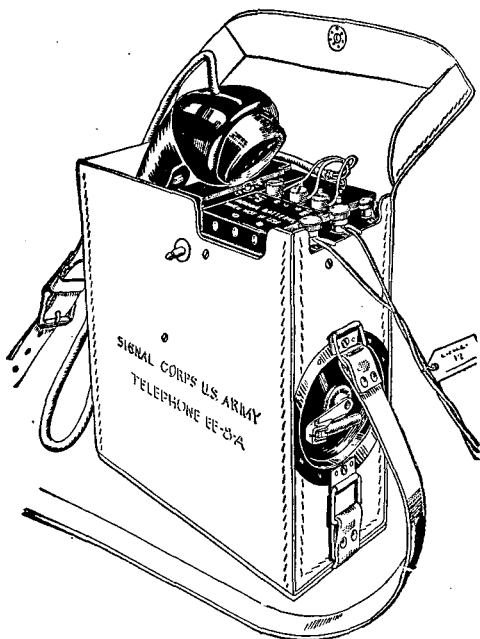

Figure 77. Telephone EE-8-A, case opened.

Telephone EE-8-A. For a detailed description, see TM 11-333.

c. Telephone TP-9. The TP-9 is a portable field telephone designed to provide two way communication on lines too long to allow satisfactory operation when using the Telephones EE-8-A or EE-8-B. When a TP-9 is substituted for a EE-8-B on each end of a line the range will be increased $2\frac{1}{2}$ to 3 times. When only one of the Telephones EE-8-B is replaced by a TP-9 the increase in range will not be as great and the operator at the TP-9 will receive a louder signal than the operator of the EE-8-B. The TP-9 consists of handset, generator and ringer (components of the EE-8-B) plus a one-tube transmitting amplifier and a two-tube receiving amplifier, mounted in a case that measures $8\frac{1}{2}$ inches by $9\frac{1}{4}$ inches by $12\frac{1}{2}$ inches. The telephone requires one Battery BA-27, one Battery BA-65 and three Batteries BA-2. These batteries are not provided with the telephone. A switch is provided to convert the telephone to the equivalent of a Telephone EE-8-B. A two-position switch is provided to shift from the ringer to a drop for silent signaling. On long lines the drop must be used in place of the ringer. The TP-9 is connected to the line wire in the same manner as the EE-8-B.

d. Telephone TP-3. (1) Telephone TP-3 provides two-way signaling and voice communication without the use of batteries. Telephones of this type are designated as sound-powered telephones. Telephone TP-3 may be connected by metallic or grounded circuits, composed of field wire, open wire lines, of cable, to any one of the following types of circuits and equipment:

- (a) Sound-powered telephones.
- (b) Local battery (magneto) telephones.
- (c) Local battery (magneto) telephone switchboards.
- (d) Two-way ring-down trunk circuits of common battery telephone switchboards.

(e) Common battery line circuits of common battery telephone switchboards.

(2) Telephone TP-3 has been classified as substitute standard, pending the development of a smaller, more compact, and more moisture-resistant, sound-powered telephone. However, its major component, the sound-powered Handsets TS-10, is used as part of Reel Equipment CE-11 (see par. 24f). The talking range of this handset over Wire W-110-B is 5 miles or more; over Wire W-130, approximately 3 miles.

45. TYPES OF FIELD SWITCHBOARDS: a. Switchboards BD-72 and BD-71. Switchboards BD-72 and



Figure 78. Switchboard BD-72 set up for operation, showing terminal compartment open.

BD-71 are portable, monocord, telephone switchboards for use primarily on field wire systems. (See TM 11-330 for complete descriptions.) Switchboard BD-72 (fig. 78) accommodates twelve telephone lines and includes four permanently connected repeating coils. Switchboard BD-71 accommodates six telephone lines and includes two permanently connected repeating coils. The height of the writing shelf (front cover of the carrying case) of both switchboards is 24 inches when the legs are extended

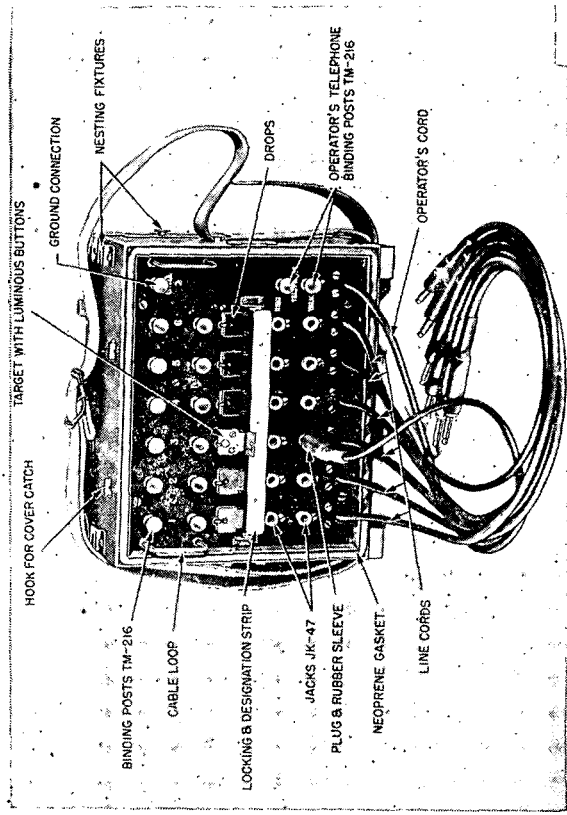

Figure 79. Switchboard SB-5/PT—front view.

fully. Both types require a total of twelve Batteries BA-30, six of these are for operation and six for spares.

b. Switchboard SB-5/PT. Switchboard SB-5/PT (fig. 79) is a 6-line, portable, monocord, switchboard for use with local battery telephone equipment. The board weighs 12 pounds and is designed so that it may be nested with from one to three additional boards of the same type. The operator's telephone and the repeating coils are not made part of the switchboard. A telephone EE-8, EE-8-A, or a EE-8-B is required for operation of the board. (See TM 11-2016 for additional data on the switchboard.)

c. Switchboard BD-14. Switchboard BD-14 has been superseded by Telephone Central Office Sets TC-4 and TC-12, for use as a division telephone central. However, due to its former wide distribution, many are still in use. Switchboards BD-14 is a portable switchboard with a line capacity of 40 local battery circuits; answering and calling cords; and ringing, ring-back, and listening keys. The switchboard is equipped with the necessary line signaling devices, operator's set, batteries and night alarm. Though not as heavy as Switchboard BD-96, the weight of the BD-14 restricts its use to places that can be reached by vehicular transportation. For complete details as to installation, operation, and maintenance of Switchboard BD-14, see TM 11-331.

d. Telephone Central Office Set TC-4. Telephone Central Office Set TC-4 is used at divisions and other headquarters requiring a switching central of the capacity of this set. The principal equipment consists of a Switchboard BD-96 and a Panel BD-97. For a complete description, see TM 11-332.

(1) *Switchboard BD-96.* The switchboard (fig. 80) is a complete transportable, single-position, manually-operated telephone switchboard for serving magneto-line traffic as well as originating and terminating trunk-line traffic. The switchboard comprises 40 line circuits, mag-

neto; 12 cord circuits; 4 common battery trunk circuits, manual and automatic; 1 first operator's telephone circuit with grouping key; 1 ringing circuit; 1 conference circuit; 1 dial cord circuit; 1 second operator's circuit; and 1 night alarm circuit. In operating position, the approximate size of the switchboard is 15 inches deep by 22 inches wide by 47 inches high. The switchboard is arranged to be packed within the angle-iron base, therefore, no additional packing case is necessary for transportation.

(2) *Panel BD-97*. The panel is arranged as shown in

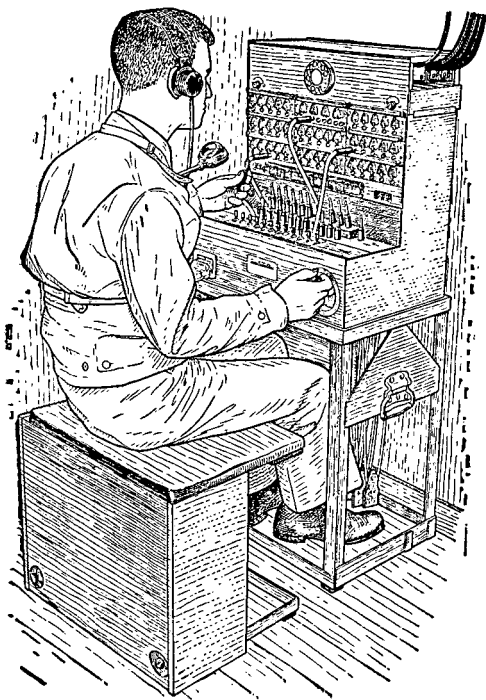

Figure 80. Switchboard BD-96 set up for operation.

figure 81. It consists of eight repeating coils C-161, four mounted on each side of the cabinet; two terminal strips of 44 binding posts each, mounted on each side of the

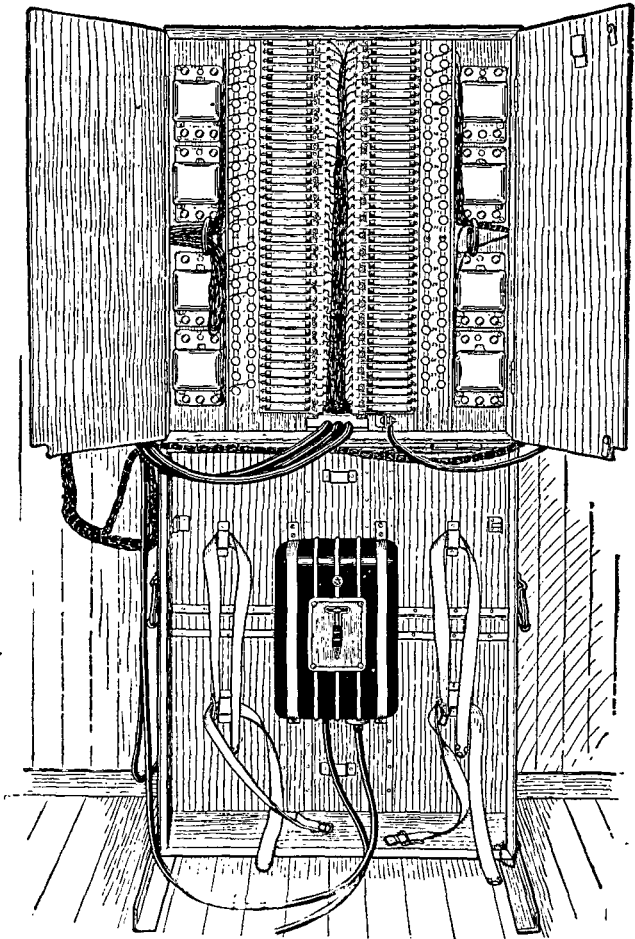

Figure 81. Panel BD-97 ready for operation.

cabinet; two vertical rows of 22 pairs of 1-ampere fuses and unit dischargers mounted in the center of the cabinet; a 20-cycle ringing machine; and three rubber covered cables, each 21 feet long and each consisting of 15 pairs for interconnecting Panel BD-97 with Switchboard BD-96. In operating position, the size of the panel is approximately 11 inches deep by 24½ inches wide by 55 inches high. A separate packing case is not necessary for transportation. A Protector AR-6 must be used externally to this panel in the line of each circuit employing a Repeating Coil C-161, in order to provide adequate protection to the coil from lightning and other abnormal currents.

e. Telephone Central Office Set TC-12. (1) Tele-

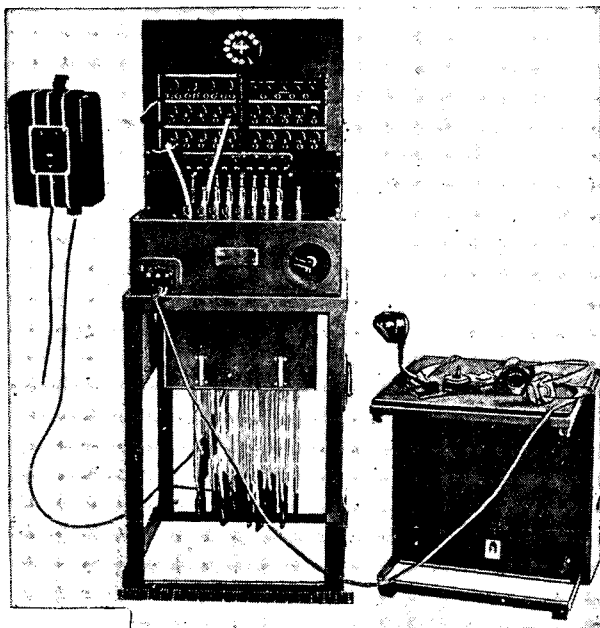

Figure 82. Switchboard BD-91 set up for operation.

phone Central Office Set TC-12 (fig. 82) comprises a Switchboard BD-91 with self-contained panel and related equipment. It is for use at division headquarters (other than infantry) and at army air force squadron headquarters. The switchboard is a complete, transportable, single-position, manually-operated telephone switchboard. It has twenty magneto line circuits and four common battery truck circuits, both manual and automatic. All

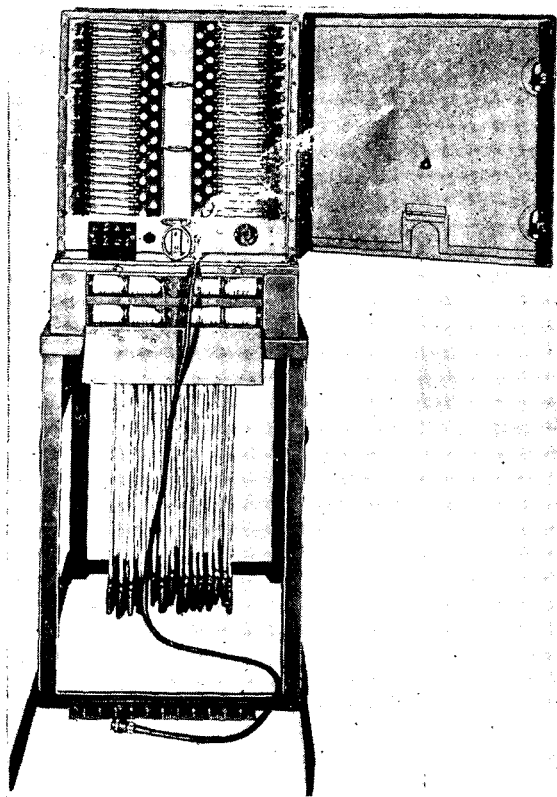

Figure 83. Switchboard BD-91—rear view, covers open.

equipment of Telephone Central Office Set TC-12 is similar to that of Telephone Central Office Set TC-4 except for certain modifications in design. For complete description see TM 11-336.

(2) Converter M-222 is a ringing machine designed to supply 20-cycle ringing current for Telephone Central Office Sets TC-4 and TC-12 when 110-volt, a-c power is not available to operate the component telering-ringing machine. The converter is a complete portable unit weighing 15 $\frac{1}{4}$ pounds with two Batteries BA-23 connected in series to provide a source of power. For complete information, refer to TM 11-344.

46. INSTALLATION OF TELEPHONE CENTRALS. **a. General.** Installation of a field telephone central includes installing the switchboard and its auxiliary equipment; terminal strips, if required; testing equipment, if available; and local circuits and telephones (except long locals). It also includes making the proper connections at the switchboard terminal strip between these local circuits and the trunk circuits turned over by construction teams.

b. Records. Each circuit is tested as soon as it is connected. When the circuit is in satisfactory operating condition the time is recorded, and the message center is informed of the available service. A traffic diagram (see par. 63) is prepared and posted at the switchboard, together with a copy of the telephone directory for the use of the operator.

c. Temporary service. Trunk circuits that are available before the switchboard is installed are connected directly to telephones to give temporary service.

d. Improving location of circuits. After the telephone central is installed and operating, circuits should be rearranged for better protection and to aid in maintenance of the line. Circuits which radiate from a telephone central are placed either overhead or underground so they

will not be subject to interference from troops and traffic in the vicinity of the command post.

e. Priority for installing telephones. (1) The sequence in which local circuits at a telephone central are installed is determined by established priorities. Normally they are installed in the following order:

(a) *Ground force units.*

1. Message center,
2. Operation section (G-3 or S-3),
3. Commander (or chief of staff, or executive),
4. Intelligence section (G-2 or S-2),
5. Supply section (G-4 or S-4),
6. Signal section (signal or communication officer),
7. Personnel section (G-1 or S-1).

(b) *Air force units.*

1. Airfields and aircraft warning outposts,
2. Operations section (A-3),
3. Commander (or chief of staff, or executive),
4. Intelligence section (A-2),
5. Signal section (signal or communication officer),
6. Message center,
7. Supply section (A-4),
8. Personnel section (A-1).

(2) Other local telephones are installed as required for other activities as soon as possible after they arrive and set up operations in the command post area. A public telephone, installed in a convenient location and at the earliest practicable time, is available for staff personnel until the telephone for their staff section has been installed. This telephone is available also for the official use of all other personnel not authorized individual telephones.

f. Use of telephones. At command posts of small units, as in battalions or regiments, one telephone ordinarily serves two or more staff officers. At larger headquarters,

more than one telephone may be required in each staff section. At all echelons telephone requirements are reduced to a minimum.

47. INSTALLATION OF TELEPHONE SWITCHBOARDS. a. **General.** A field telephone central may include one or more switchboards, depending on the number of trunk and local circuits to be installed. With certain types of switchboards, it is necessary to install terminal strips; with others, the terminal strips and the repeating coils are contained in the switchboard itself. The switchboard and its associated equipment are installed in a centrally located place with as much shelter and freedom from noise and interference as possible, and is concealed from observation. Cover from fire is provided at the earliest practicable moment. Frequently it is convenient, particularly in rapidly moving situations, to install switchboards in vehicles. However, except in armored units, telephone switchboards must

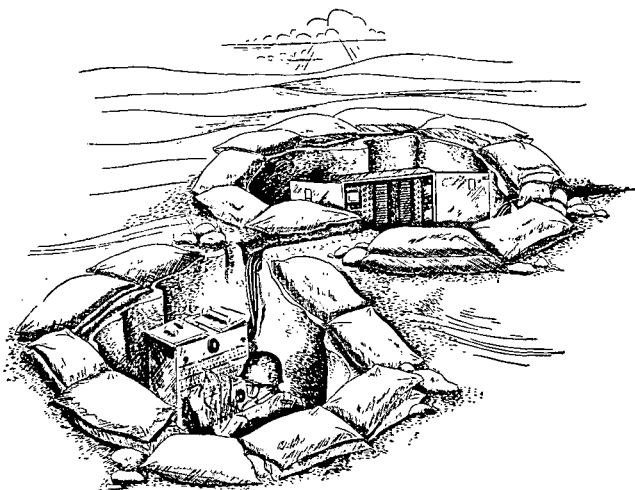

Figure 84. Telephone Central Office Set TC-4, dug in.

not be permanently mounted in trucks. Figure 84 shows a Telephone Central Office Set TC-4 dug into the ground for protection against aerial attack. Such an installation should be camouflaged to blend with its surroundings. Overhead cover may be provided.

b. Installation of Switchboards BD-72 and BD-71. (1) Preparation for use. If the switchboard is placed on a table or other support, leave the legs folded and locked in place. Otherwise, turn the case on its side, unlock and unfold the legs, and extend them to full length by pressing the spring release button on each leg. Lift the switchboard, and place all four legs firmly on the ground. Open the front compartment. The lower panel serves as a desk, and the upper panel can be pushed back into the recess beneath the top of the case or adjusted as a rain or sun shield. Pull out the cords from beneath the switchboard line units and allow them to hang freely in front of the shelf. The plugs should clear the ground so as not to collect dirt which may later foul the line jacks. Lower the spring-locking bars on the line drops of the line units to the horizontal position. The drops should fall freely of their own weight when energized by an incoming signal; this may require a slight forward tilt of the switchboard. Open the battery case inside the rear compartment (see fig. 85). Place two Batteries BA-30 in series in the right-hand division of the case; these batteries furnish talking current for the operator's set. Place two pairs of batteries in series in the left-hand division, these operate the night alarm and panel lights. The bottoms of the batteries must make good contact to the coiled springs. The brass caps of the other batteries of any pair should seat firmly on the contact plate in the middle of the compartment. The contact between the batteries of a pair should also be clean and firm. Tighten all connections, and, in general, follow the maintenance procedure in TM 11-330. The operator's head and chest set is plugged into the panel on the

left of the switchboard units. The three binding posts marked T, C, R, immediately above the plug receptacle, are wired in parallel with the plug contacts; this makes possible the use of a field telephone handset or other suitable telephone transmitter and receiver in an emergency. Terminal T connects to the telephone transmitter, terminal R to the receiver, and terminal C to the common connection between them.

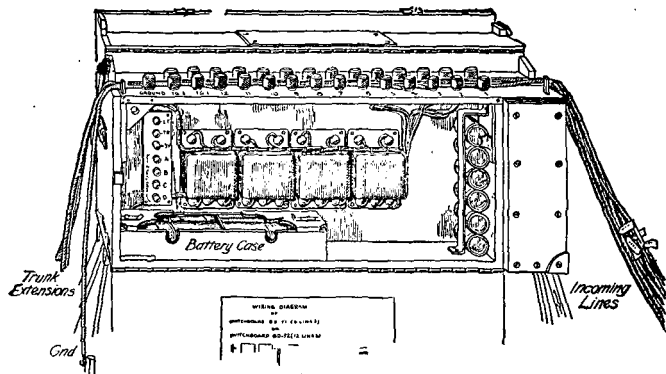

Figure 85. Switchboard BD-72—rear view, compartments open.

(2) *Preliminary tests.* Select any line unit and see that the corresponding line binding post in the terminal compartment is clear. Raise the key of the line unit to the ring position (up), and crank the ringing generator. It should turn freely. Short-circuiting the two line terminals should produce a definite drag on the generator when the key is in the ring position. Remove the short circuit. Blow lightly into the transmitter (chest toggle switch in locked position), and throw the key of any line unit to the talk position (down). Sidetone should be clearly audible with the switch down, but not present when in the neutral position. Connect a serviceable field telephone to the line binding posts of the first line unit.

Crank the generator of the field telephone. The shutter of the line drop of the first unit should fall. Test the night alarm circuits by throwing the NT AL toggle switch to the right. The alarm bell should start ringing. Ringing should stop when the shutter is reset. Ring the field telephone by cranking the generator and throwing the key to ring (up). The bell, or buzzer, of the field telephone should operate energetically. Depress the key to the talk position (down). Conversation should be possible without effort. Test each line successively in the same manner.

(3) *Line connections.* (a) *Procedure.* Connect field wire lines, properly tagged, to the binding posts (numbered in pairs from 1 to 6 in Switchboard BD-71, and 1 to 12 in Switchboard BD-72) in the top rear compartment of the switchboard (see fig. 85). To assure good contact, a small amount of insulation is stripped, and the bared wire secured in the binding post slot by tightening the knurled head of the post by hand. Each pair of posts is connected internally to a correspondingly marked line unit, comprising a line drop, plug and cord, jack, and key switch. The field wires may enter the line compartment from either the left or right, but should place no mechanical strain on the switchboard (see fig. 78). The drip loop illustrated prevents water from running down the field wires into the switchboard. Trunk lines should be connected to the lower-numbered line circuits on the board, since these are connected to the repeating coils for simplex use. (Line circuits 1 and 2 on the 6-line Switchboard BD-71, and 1, 2, 3, and 4 on the 12-line Switchboard BD-72.) Local circuits should be connected to the higher-numbered line circuits. This is a convenient manner of distinguishing between trunk and local circuits, and facilitates switchboard operation.

(b) *Extension of trunks.* Since trunk circuits are likely to be extended along the axis of signal communication, such trunks should enter the switchboard from one end

and be carried completely through the switchboard, with about 3 feet of wire being allowed to hang freely from the opposite end (see fig. 83). (The free ends of these wires should be taped.) When the splices are completed, the new switchboard at the extended position takes over. Then the trunk lines are removed from the binding posts, and the wires taped. Continuity of communication is maintained thereby.

(c) *Simplex circuits.* The telegraph legs of the simplex line circuits are marked TG-1 and TG-2 in Switchboard BD-71, and TG-1, TG-2, TG-3 and TG-4 in Switchboard BD-72 (see fig. 85). The GROUND binding post should be connected to the metal ground rod or stake driven in the earth near the switchboard. The wire used to make this connection should be free of kinks and bends. This provides lightning protection to the system by means of small spark-gaps between each line terminal and ground. *Grounds for simplex circuits must be independent of the switchboard ground connection.*

c. **Installation of Switchboard SB-5/PT.** See TM-11-2016.

d. **Installation of Switchboard BD-14.** See TM 11-331.

e. **Installation of Telephone Central Office Set TC-4.** Turn the switchboard and base upside down, remove the seat top, and extend the extension legs of the base. Ease the equipment to an upright position and lift the base off the switchboard, setting it in the desired position for the switchboard. Set the switchboard on the base, making sure that the dowels in the base of the switchboard enter the holes in the top of the base. Unfasten the cord compartment, allowing the cords and the weights to drop into position. Clamp the switchboard to the base by means of the two wing-nut bolts provided. Remove the front cover of the switchboard and raise the designation strip, permitting the drops to fall. Fasten the seat top to the switchboard cover to form

an operator's chair. Install six Batteries BA-30 in the compartment in the lower rear of the switchboard. (When more than one switchboard is in use, set up the additional units successively, adjacent to the first unit and in a similar manner.) Set Panel BD-97 in a suitable location within cabling distance of the switchboard. Loosen the bars on the outside of the case, and raise the upper half of the panel (the half without the handles) until it is vertical. Fasten the two lower bars of the upper cabinet to the top bolts of the lower cabinet as a brace. Unstrap the cables and remove the two angle irons chained to the panel. Fasten these angle irons to the bottom of the lower cabinet to form extension legs. Slots are provided in the angle irons to allow mounting Panel BD-97 either at the center or at the end of the angle irons, permitting installation against a wall. The upper cabinet may be removed and suspended on a wall by means of hangers at each corner. The ringing machine may be removed also. Connect the three cables to the three rows of binding posts in the top of the switchboard as designated. (Local battery trunk circuits should be terminated in line jacks.) Install the ground rod and connect it to the ground terminal of Panel BD-97. A Protector AR-6 must be used externally to this panel in the line of each circuit employing Repeat Coil C-161 in order to provide adequate protection to the coil from lightning or other abnormal currents. Connect the incoming lines to binding posts in the upper cabinet. When a 110-volt, 60-cycle, power source is available, plug the power cord of the ringing source into a convenient outlet, and extend ringing current to the switchboard by means of Cord CD-451. The switchboard termination for ringing power is located on the panel in the top of the switchboard.

f. Installation of Telephone Central Office Set TC-12. Turn the switchboard and base upside down, remove the seat top, and extend the extension legs of the base. Ease

the switchboard outward upon the ground, lift the base upward, and place in the desired operating location. Set the switchboard on the base, making sure that the dowels on the switchboard fit into the holes in the top of the base. Unfasten the cord compartment, allowing the cords and weights to drop into position. Clamp the switchboard to the base by means of the two wing-nut bolts. Remove the front cover of the switchboard and raise the designation strips, permitting the drops to fall. Swing the retractable legs out from the open end of the switchboard cover until the side braces snap into the slots. Fit the hooks under the seat top into the holes in the angle brackets, and fasten in place by means of the slide bolts for use as an operator's chair. Install eight Batteries BA-30 in the compartments in the lower back of the switchboard. If an external battery is to be used for the night-alarm circuit, do not install any battery in the compartment designated NA BATT. Connect the incoming lines to the binding posts mounted on the protector panel at the rear of the switchboard. The first four line circuits are equipped with repeating coils. The telegraph legs are brought to the four binding posts, designated as follows:

1	2
TELEGRAPH	
3	4

To group two switchboards, A and B, connect Cord CD-611, grouping cord of switchboard A to the receptacle designated GROUPING on switchboard B, and connect switchboard B to A in the same manner. When 110-volt, 60-cycle alternating current is available, plug the Telering cable into a convenient outlet. Extend ringing current from the Telering to the switchboard by means of Cord CD-452. The receptacle for this cord on the switchboard is located in the lower back, and is

designated POWER RINGING. The Telering may be removed from the switchboard cover and hung up in a convenient location. When 110-volt, 60-cycle, alternating current is not available, Converter M-222 may be used. (TM 11-344.) Connect Cord CD-258 to the GRD terminal on the lower part of the back of the switchboard, and to Ground Rod GR-29 driven into the ground. Plug Head and Chest Set HS-19 into the Jack JK-37, mounted in the front of the key shelf.

48. CONVERSION OF TEST POINTS TO TELEPHONE CENTRALS.

a. If a command post is established where a test point has been installed previously, the test point can be converted easily into a telephone central. At a test point that is to be converted into a telephone central, lines will be placed overhead. If it becomes necessary to use a test point not designated as a probable future telephone central, run the circuits overhead before the conversion takes place.

b. The switchboard is set up as near the test point as possible, in order to facilitate the cut-over. The two switchboard units to which the two sections of the circuit are to be connected are plugged through to each other. The sections of the circuit being cut over are interconnected around the terminal strips of the test point by means of test leads equipped with clips. With the circuit bridged around the terminal strip, it may be removed from the test point and installed in the main frame or terminal strip of the switching central. Remove test clips quickly to prevent any possible cross on the line. The remaining circuits are transferred in like manner.

c. When the transfer is completed, the operator listens in on each circuit that enters the switchboard and, if the circuit is not busy, removes the patching connection. The operator then calls over each circuit, and informs the answering operator that the test point has been converted

into a telephone central, at the same time giving directory names and any other pertinent information.

49. INSTALLATION OF TELEPHONES. a. General.

Both common battery and local battery telephones are used in field wire systems, sometimes in the same installation. Within divisions, however, the instruments are usually local battery (magneto). Telephones should be installed in a position convenient to the user, with the field wire connection tied in near the instrument, leaving sufficient slack between the tie and the instrument to permit some movement of the telephone. If the circuit enters the place of installation from overhead, a drip loop is inserted to drain water away from the instrument (see fig. 29). If the telephone is strapped to a tree trunk or tent pole, tie down the instrument firmly with a short length of field wire in a manner providing easy access to the handset and generator crank. Attach to each telephone the telephone directory tag (par. 64) and a tag bearing the directory name and number of that telephone. When an installation has been tested and is completed, the user is informed immediately of that fact.

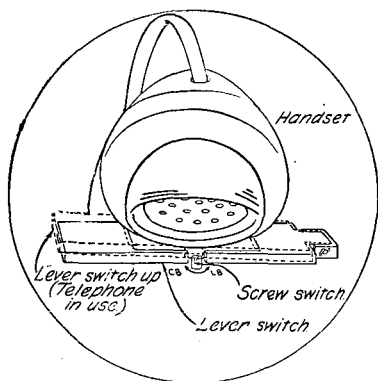

Figure 86. Position of handset on lever switch in common battery operation.

b. Telephone EE-8-A and EE-8-B. (1) *Installation.* Place two Batteries BA-30 in the compartment under the lever switch. This compartment is accessible when the handset is removed from the case. Make certain that the bottoms of the batteries rest on the springs, and that the brass caps rest securely on the contacts at the top of the battery compartment. Connect the field wire conductors to the binding posts L₁ and L₂.

(2) *Local battery operation.* When using Telephone EE-8-A or EE-8-B on local battery systems, turn the screw switch near the lever switch (fig. 86) with a screw driver counterclockwise (to the left) until it comes to a stop.

(a) *To signal,* turn the generator rapidly for several turns.

(b) *To talk and listen,* hold the handset with the receiver to the ear. While talking, operate the head set switch with the thumb. Talk directly into the transmitter. When listening, release the switch. This conserves battery strength, cuts out outside noises originating near the telephone, and eliminates electrical losses in the transmitter. When a gas mask is worn the intelligibility of telephone conversations is affected. This can be overcome partially by holding the transmitter directly in front of and close to the speech diaphragm of the *diaphragm* type gas mask or the outlet valve of the *service type* gas mask while talking. Holding the transmitter in this position may cause the receiver to be moved away from the ear. In this case, the person at the other end of the line must be informed that a gas mask is being worn by the speaker and that the procedure word "over" will be used each time he has finished talking to indicate that he is ready to listen. This procedure is necessary to prevent the person at the distant end from speaking when he cannot be heard by the person wearing the gas mask. A more positive method of overcoming low intelligibility when wearing the gas mask is to use a lip microphone.

The Lip Microphone T-45 is designed to plug into the Head and Chest Set TD-3 (or a modified HS-19) so that the head set and the lip microphone may be employed as a unit. The head and chest set, in turn, can be plugged into the receptical jack on the Telephone EE-8-A or EE-8-B. The lip microphone must be adjusted to the wearer prior to donning the mask. A throat microphone may be similarly employed though the intelligibility is more dependent upon proper adjustment to the wearer.

(c) *To ring off*, turn the generator rapidly for several turns. This indicates to the switchboard operator that the conversation is ended or that a new connection is desired. After ringing off, replace the handset in the case if a new connection is not desired. Let the cord hang out.

(3) *Common battery operation*. Turn the screw switch, near the lever switch, clockwise (to the right) with a screw driver until it comes to a stop. The lever switch (fig. 86) is an essential part of the telephone in common battery operation, corresponding to the hook or plunger switch on commercial telephones. When not in use, the handset is placed with the transmitter up, resting upon and depressing the lever switch (see fig. 86).

(a) *To call*, remove the handset from its position on the lever switch. (The lever switch is then released, as shown by the dotted lines in figure 86.) If the switchboard operator does not answer, depress and release the lever switch, *slowly*, several times. This flashes the line lamp at the switchboard, giving notice to the operator.

(b) *To talk and listen*, proceed as in (2)(b) above. Batteries BA-30 furnish talking current for common battery as well as for local battery operation.

(c) *To recall the operator*, push the lever switch down and release *slowly* several times.

(d) *To indicate completion of call*, replace the handset, depressing the lever switch.

(e) *To close station*, the person removing the telephone should call the telephone central or other party on the line, before disconnecting the telephone and inform him that the telephone is being removed from the circuit. Remove the connections to L_1 and L_2 . Remove Batteries BA-30, unless the telephone is to be installed on another circuit immediately. Highly corrosive chemicals, injurious to the telephone, leak out of rundown batteries. Fold the rubber-covered cord loosely into folds about as long as the handset, place the folds alongside the handset, and insert the handset (receiver end first) into the case. The cord also may be handled conveniently by holding the handset in the left hand, placing the thumb against the receiver case, and wrapping the cord in long folds completely around the handset. In either case, *do not wrap the cord around the handle of the handset* as this will injure the cord and may operate the handset switch. The switch must be left in neutral position (wings parallel to the handle) to prevent rapid running down of the batteries when they are left in the instrument.

50. TELEPHONE REPEATER EE-89-A. Telephone Repeaters EE-89-A are used to give improved transmission and to extend the voice-frequency talking range over Wire W-110-B or other facilities. It is a 21-type repeater. Two-wire transmission is used, that is, the same pair is used for transmission in both directions. This repeater is for use as an intermediate repeater, and for best results it should be located approximately in the center of the line so that the equipment on either side of the repeater will have similar characteristics. Normal simplex telegraph operation and 20-cycle ringing are possible over lines equipped with one or more of these repeaters. For information on installation, operation, and maintenance of this equipment, refer to TM 11-2006.

51. REPEATING COILS. a. General. Repeating coils are used in field wire systems to make possible the construction of simplex and phantom circuits for additional telegraph, teletypewriter, or telephone channels. The coils consist of two windings on a magnetic core, carefully balanced to prevent crosstalk. The ends of one winding are brought out to two terminals, marked **LINE**, that are connected to the incoming wire line. The ends of the other winding are brought out to two terminals, marked **SWITCHBOARD**, that are connected to the switchboard line terminals. The midpoint of the line side of the coil is brought out to a fifth terminal, marked **TELEG**, that can be connected to provide a simplex or phantom circuit (see pars. 52 and 53).

b. Types. (1) *Military.* Coils commonly issued for use in the field are Coil C-75 and Coil C-161 (see fig. 87). These are similar in electrical characteristics, but Coil C-161 is more efficient, smaller, and lighter.

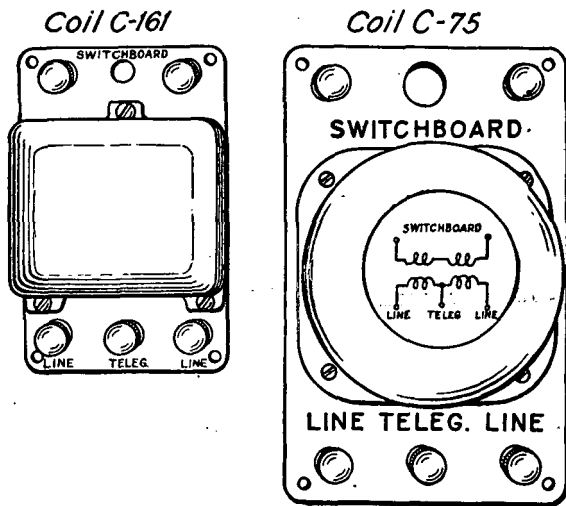

Figure 87. Coils C-161 and C-75 (repeating).

(2) *Commercial.* Commercial repeating coils of the type illustrated in figure 88 may be issued. These have windings brought out to soldering terminals numbered 1 to 8. Before being taken into the field, these coils should be mounted on a wood base and wired to five binding posts lettered as shown in figure 88. The connections are made with insulated wire soldered to the coil terminals. These coils are designed to withstand moisture and a certain amount of rough handling, but may fail due to broken connections and corroded or dirty terminals. Before installation, the coils should be inspected for broken or loose connections outside of the metal cover. Defective connections should be resoldered, and corroded or dirty terminals should be cleaned thoroughly with sandpaper or emery cloth.

c. **Test.** To test repeating coils, connect the coil under

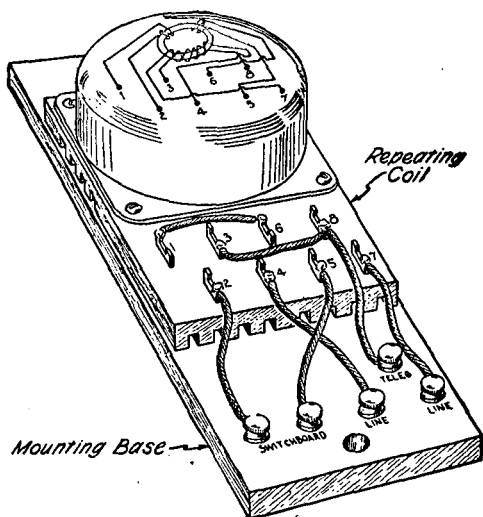

Figure 88. Commercial repeating coil mounted and wired to binding posts.

test to a good coil with a short length of wire in the manner shown in figure 88 for simplexing a line. The ground should be an actual wire connection for this test. Then connect four serviceable telephones to the two coils, one pair of telephones to the metallic circuit, and one pair of telephones to the simplex circuit which is completed through the wire replacing the ground return circuit. The test consists in ringing and talking over each circuit. If unable to ring or talk over either circuit, test each of the short wire connectors, both for continuity and for cross connection, with all other wires. If the circuits are clear of trouble, the coil windings which are inside the iron case are probably defective. If the first test shows that both circuits are clear, ring and talk over each circuit while listening over the other circuit. If ringing or talking over one circuit can be heard loudly over the other circuit, the coil is defective and should be turned in for repair.

52. SIMPLEX CIRCUIT (fig. 89). a. The simplex circuit (par. 5c(1)) is obtained by placing a repeating coil at each end of a metallic circuit (par. 51). Usually the coil at each end is located in the line as close to the switchboard terminal strip as practicable. The binding

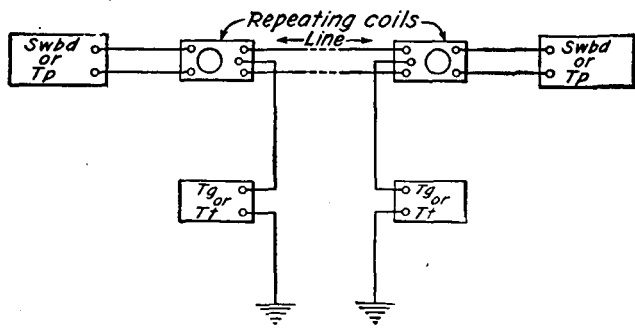

Figure 89. Simplex circuit constructed with repeating coils.

posts marked **LINE** are connected directly to the line, and those marked **SWITCHBOARD** are connected to the desired line terminals on the switchboard. The telephone circuit is completed inductively through the coil. The binding post marked **TELEG** is connected to one line terminal of the telegraph set. Usually this line to the telegraph set is referred to as the telegraph leg. Ordinarily the other line terminal of the telegraph set is connected to a suitable ground near the instrument.

b. When a telephone is installed on a simplex line without a switchboard, the repeating coil terminals marked **SWITCHBOARD** are connected directly to the telephone.

c. Switchboards integrally equipped with repeating coils and terminal strips have the repeating coils permanently connected between the switchboard terminal strips and certain line units. The simplex circuit is then obtained by connecting the desired line to the proper line terminals on the switchboard, and running the telegraph leg from the corresponding telegraph binding post to the telegraph set.

53. PHANTOM CIRCUIT. a. A phantom circuit (fig. 90) may be constructed from two metallic circuits and

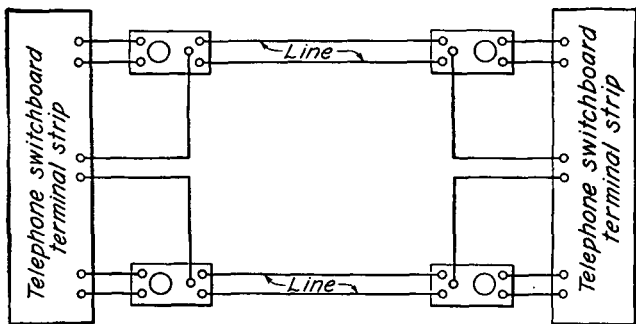

Figure 90. Phantom circuits constructed with repeating coils.

four repeating coils, two at each end of the lines. Except for the telegraph legs the coils are connected as in paragraph 52. The two binding posts marked TELEG at each end of the lines form the phantom circuit, and may be connected to an unused pair of line terminals at the switchboard.

b. If desired, the phantom circuit thus formed may be simplexed itself to obtain a telegraph circuit in the same manner as described in paragraph 52 for a single metallic circuit. This requires the use of an additional repeating coil at each end of the lines (see fig. 91).

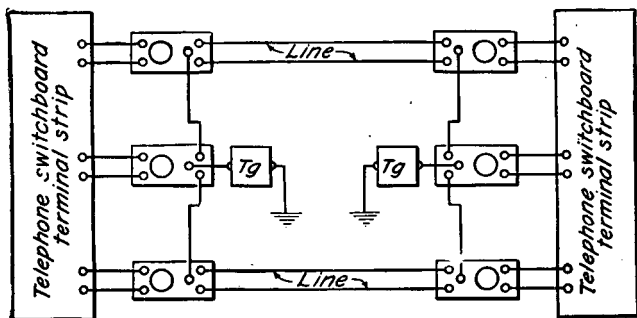

Figure 91. Simplexed phantom circuit.

54. MUTUAL INTERFERENCE IN SIMPLEX AND PHANTOM GROUPS. a. In connections of simplex and phantom groups, mutual interference between simultaneous signals in different channels will result when all wires in the simplex or phantom group do not have exactly the same impedance. The circuits, then, are said to be unbalanced, and the amount of the interference will depend upon the degree of unbalance between the two physical (metallic) circuits. The primary causes are poor splices, which introduce a high resistance into either side of the circuit; and improperly taped splices

or damaged insulation which, particularly when the line is wet, result in excessive leakage from one side of the circuit to ground. Although it is impossible to obtain a perfect impedance balance in field wire circuits, mutual interference may be reduced to a negligible value by making certain that each wire of a group is of approximately the same length, and that all splices are well made. In addition, overhead construction at low, wet places and during rainy weather will assist in reducing interference.

b. Usually the interference resulting from any unbalance is more pronounced in a phantom group than in a simplex circuit, as there are more circuits involved in the former. Furthermore, due to their similarity of sound, interference between telephone channels is much more serious than the interference from telegraph key clicks. Therefore, a phantom circuit should not be used in field wire systems except where it is essential to provide an additional talking channel. Simplex circuits, on the other hand, are used normally to provide telegraph channels, and their use on field lines is common.

Section II. OPERATION

55. SWITCHBOARD OPERATOR. Switchboard operators should be courteous, intelligent, efficient, capable of working for prolonged periods under pressure, able to speak distinctly, and able to understand speech readily over the telephone. They should be familiar with army organization. Switchboard operators can be of great assistance to the wire chief by keeping him informed of the conditions of the circuits.

56. SWITCHBOARD OPERATION. a. **Switchboards BD-72 and BD-71.** The operator should be seated so that he may observe all drops and operate the switchboard conveniently. The head and chest set should be ad-

justed for comfort, with the mouthpiece about $\frac{1}{2}$ inch from the operator's lips. The toggle switch on the chest unit is set to the lock position so as to close the transmitter circuit. This will not cause a constant drain on the talking batteries since the circuit is not completed until the key of a line unit is placed in the talk position. The night alarm is turned on by the NT AL toggle switch, and the panel lights, used only for answering calls at night (if conditions warrant their use), are turned on by the LT toggle switch.

(1) *Incoming call.* An incoming call is indicated by the falling of the line drop of the calling line. (This will operate the night alarm when it is turned on.) Depress the key of the calling line unit to the talk position (down), and answer the party (or telephone central) calling. At the same time, pick up the calling party's plug. After determining the party (or telephone central) to be called, restore the calling party's key to the neutral (mid) position. Ring the called party by raising the key of that line unit to the ring position (up), and turn the generator crank rapidly several times.

Caution: Unless the calling party's key switch is restored to the neutral position, ringing back into the ear of the calling party will result.

Immediately after ringing, depress the called party's key to talk and, if the call is local, insert the calling party's plug into the called party's jack. If the call is not local, pass the call to the distant operator before making the connection. After the connection has been made, the operator's telephone is bridged across the connection, enabling him to supervise the call. The called party's key may be left down until conversation has begun or, in the case of the trunk call, until the call has been passed to the distant operator. When the call has been supervised, the called party's key and the calling party's drop should be restored. In case it is necessary for the operator to answer another call before he has

supervised the first connection properly, he restores the key but leaves the drop down and proceeds to handle the other call. At the first opportunity, he returns and supervises the first connection, restoring the drop after he has done so. A drop is not restored on a connection until it has been supervised and, when left in the down position, indicates a connection that still requires supervision. A connection that has been established and is in use can be supervised by depressing the key of the called party's line unit, listening, and challenging if necessary. The operator should not throw two keys in the talk position at the same time since the two circuits would be coupled thereby through the operator's set, resulting in cross talk on both circuits. After talking to either party, the operator always restores the key to neutral before beginning any other operation.

(2) *Completed call.* When a conversation is completed and either of two connected parties rings off (turns the generator of his telephone), the drop of the calling party's line unit will fall. The operator should then depress the key and answer the signal to see if either party desired another connection. If no reply is received, he takes down the connection by removing the plug from the called party's jack, and restores the drop and key. Never pull on the cord to remove the plug from the jack.

Caution: The line drop of the other unit will not fall, since it is automatically removed from the circuit when the plug of the calling party was inserted in the jack of the unit. In case another call is desired by either party, the operator must inquire to ascertain which party is making this request.

(3) *Conference call.* The operator informs the party desiring the conference connection that he may or may not hold the line, as he prefers. Restore the calling party's key, ring the first of the called parties (par. 55a(1)) and advise him to hold the line for a conference

call. Restore his key, and insert the calling party's plug in his jack. Pick up the first called party's plug and ring the second called party. When the second party answers, have him hold the line for a conference call also, restore his key, and insert the first-called party's plug into the second-called party's jack. Extend the connection in a similar manner to each of the called parties in turn. When the last of the called parties has been connected, contact the calling party and inform him that all parties are now on the line. When the conversation has begun, restore the calling party's key and drop. All parties are bridged together (at the switchboard) so that each can talk or listen to any of the others. The drop of the calling party remains bridged across the connection for a supervisory signal, as in any ordinary call. The connection may be supervised by depressing the key of any one of the connected line units.

(4) *Removal of switchboard from service.* Before removing any connections, notify all parties connected that the switchboard is being removed from service. When the switchboard is to be removed from service, disconnect all lines from the terminal strip. Remove the batteries from the case if the switchboard is not to be placed in service again within 24 hours. Put the operator's chest and head set in the left front compartment. Lock all line drops. Clean out any dust or dirt accumulations. Place the line cords under the line units. Carefully close all the covers, and retract and lock the legs of the switchboard.

b. Switchboard BD-96. The operation of this switchboard is similar to that of comparable commercial switchboard practice.

(1) *Incoming calls.* The drop signals indicate a call on a line or trunk. When a call is received, insert the answering (back) plug in the jack associated with the signal. Connect the operator to the circuit by operating the TALKING key, associated with the cord used, to

the locking (TALK) position (away from the operator).

(2) *Outgoing calls.* To call a number, insert the calling (front) plug in the desired party's line, and operate the key associated with the cord used to the nonlocking (RING) position (toward the operator). If the power ringer is not operating, turn the hand generator while holding the key in the RING position.

(3) *Supervision.* Supervision is provided by drops located on the face of the board directly above the associated plugs. Ring-off or recall is indicated by these drops falling.

(4) *Dial trunk calls.* Answer the local station in the usual manner, using an answering cord. Insert the corresponding calling cord in the desired trunk line jack (marked L), and listen for dial tone. When dial tone is heard, plug the dial cord into the associated dial jack (marked D) and dial the number. Remove the dial cord and listen for ringing tone. It is not necessary to ring on the trunk.

(5) *Common battery manual trunk calls.* Answer the local station in the usual manner, using an answering cord. Plug the corresponding calling cord into the desired trunk line jack (marked L). The act of plugging in the trunk line jack signals the manual operator, and it is, therefore, unnecessary to ring on the trunk.

(6) *Conference calls.* To connect a number of lines together for conference, the answering cord plug is inserted in the line jack of the party originating the conference call. The associated calling plug is then inserted in one of the six conference call jacks. The other connections to the conference are made by inserting the answering cord plugs in one of the conference circuit jacks, and inserting the associated calling plug in the line jack of the party to be called. The operator must call each member of the conference in the usual manner.

(7) *Second operator's telephone circuit.* A key, marked OPERATOR 1-2, is provided for disconnecting cord

circuits 9 to 12, inclusive, from the operator's telephone circuit and transferring them to the second operator's telephone circuit during periods of heavy traffic. The second operator uses a Telephone EE-8-A for an operator's set. Terminals for connecting the second operator's telephone set are located in the top of the switchboard.

57. OPERATING PHRASES. The following phrases are prescribed for use by switchboard operators in all cases where they apply, to the exclusion of other phrases of similar meaning.

a. "*Magic operator.*" Used by an operator in answering a call at the switchboard of the unit whose directory name is *Magic*.

b. "*Magic —.*" (Blank is appropriate directory number.) Used by an operator to indicate that he has understood correctly a number given to him either by a local party or by an operator of another telephone central, and that he is proceeding to complete the call.

c. "*What number please?*" Used by an operator to request repetition of a number which he has not understood.

d. "*The line is busy.*" Used by an operator to report that a local telephone for which he has received a call is already in use.

e. "*Maytime is busy.*" Used by an operator who has received a call intended for a certain telephone central (Maytime), to report that all trunks to that central are in use.

f. "*Magic three-three does not answer.*" Used by an operator to report that a called party (Magic three-three) does not answer.

g. "*Maytime does not answer.*" Used by an operator to report that a certain called telephone central (Maytime) does not answer.

h. "*Here's your party.*" Used by an operator to notify

the calling party that a connection is complete and that conversation may begin.

i. "*Have you finished?*" Used by an operator in supervising a connection, when no conversation is heard. Repeat the challenge if no reply is heard.

j. "*I will ring again.*" Used by an operator when, in supervising a connection, he is informed that the called party did not answer.

k. "*What number is calling, please?*" Used by an operator if, after supervising a connection, he is given a new number to call by one of the parties but is unable to identify the party.

l. "*Magic three-zero has no telephone but I can give you Magic one-one.*" Used by an operator when there is no telephone at the number called, but another telephone is available to which the calling party may wish to be connected.

m. "*What number were you calling, please?*" Used by an operator to determine the number desired by a party who reports he has been given a wrong number or has been cut off.

n. "*One moment, please,*" or "*I have a call for you.*" Used by an operator, if necessary, to hold either party on the line while a connection is being completed.

o. "*Calling Magic,*" or "*Calling Magic one-one.*" Used by an operator when there is confusion or interruption in getting an operator or called party on the line.

58. SUPERVISION. a. **New connection.** A switchboard operator supervises each connection to make certain that conversation is established between the calling party and the called party, and to remove the connection as soon as possible after the conversation is completed. The operator listens in after he has made a connection and rung the called party, waiting to hear the called party answer and conversation begin. He remains in on the connection of a trunk call to another telephone cen-

tral, until that central has answered and he has passed the call to it. If it is necessary for the operator to answer another call before he has supervised a connection, he does so and then completes the supervision at the first opportunity. A shutter is never restored on a connection until it has been supervised.

b. Established connection. If the operator does not hear any conversation when supervising a connection which has already been established, he challenges by asking, "Have you finished?" Great care is taken not to interrupt a conversation in progress. If after a second challenge he receives no response, he takes down the connection. Connections are supervised frequently in this manner in case both parties may have failed to ring off when the conversation was completed. If the operator is notified that the called party has not answered he answers, "I will ring again," and does so. If he is informed that the connection is still in use, he restores his listening key to the normal (mid) position.

c. Completed calls. Normally, when a conversation is completed, the drop on the connection will fall due to one of the parties ringing off. This is the signal for the operator to supervise the connection in the manner described in b above. If a new number is given him by either party, he asks, "What number is calling, please?" and proceeds to complete the call in the usual manner.

59. TELEPHONE CONVERSATIONS. a. Placing calls. In placing a telephone call, the complete designation of the party desired is given to the switchboard operator (directory name of the unit and directory number of the party). However, in placing a call to a party at the same headquarters or echelon as that served by the switchboard, it is not necessary to give the directory name of the unit.

b. Answering calls. In answering a telephone call, the expression "Hello" should *not* be used. The individual

answering the call states the directory name and number of the telephone and identifies himself. As per example "Magic three, S-3 speaking."

c. Brevity and security. Telephone conversations should be kept as brief as possible, so as not to deprive others of the use of the circuits. The calling party can help considerably in this regard by planning beforehand just what he expects to say. The telephone should not be used for long reports, long orders, or long messages when messenger or telegraph service is available. Conversations must be discreet since there is never any certainty of secrecy. Messages may be intercepted by direct tapping of the line, by induction from the lines, and by leaks to the ground.

d. Dealings with the operator. The switchboard operator always should be treated courteously, but no unnecessary conversations should be held with him. Any complaint regarding the service should be made to the chief operator or to the signal or communication officer. The operator should not be directed as to how to route a call, nor should the calling party attempt to route his own call by merely asking for a connection to a certain central. The operator is best prepared to put through a call with minimum delay when he is given the complete designation of the party to be called and nothing more.

60. CONFERENCE CALLS. a. Purpose. At certain times, it is desirable for a commander or one of his staff officers to obtain telephone connections with two or more individuals at the same time so that he may transmit instructions or information to all parties simultaneously. For this reason, the conference call is used.

b. Procedure. A calling party who wishes to obtain a conference call, informs the operator by saying "Conference call," and gives the telephone directory designations of the parties desired, such as Dragoon Six, Domino Six and Diamond Six. Then he gives his own directory

designation, if necessary. The calling party may instruct the operator that in case the particular party called is not available, other staff officers or their assistants will be satisfactory. After placing a conference call, the calling party may hang up to wait recall by the operator.

61. PHONETIC ALPHABET. a. Pronunciation of letters. Certain letters of the alphabet have similar sounds and often are confused in telephone conversations. To avoid this difficulty, the following pronunciation of letters is prescribed for all voice communication, including telephone and radio:

Letter	Spoken as—	Letter	Spoken as—	Letter	Spoken as—
A....	Able	J....	Jig	S....	Sugar
B....	Baker	K....	King	T....	Tare
C....	Charlie	L....	Love	U....	Uncle
D....	Dog	M....	Mike	V....	Victor
E....	Easy	N....	Nan	W....	William
F....	Fox	O....	Oboe	X....	X-ray
G....	George	P....	Peter	Y....	Yoke
H....	How	Q....	Queen	Z....	Zebra
I....	Item	R....	Roger		

Note. The letters A, I, N, O, and P are pronounced Afirm, Interrogatory, Negat, Option, and Prep, respectively, when the U. S. Navy General Signal Book is used.

b. Procedure. The words of the phonetic alphabet are used in place of the letters they represent, just as in spelling a word. Expressions such as "A as in Able" or "A for Able" are not used. For example, in transmitting the words "Barts church" the word "Barts" is likely to be misunderstood. The transmission is as follows: "Barts, spelled Baker—Able—Roger—Tare—Sugar, Barts church."

c. Coded messages. The phonetic alphabet is used also in the transmission of coded messages by telephone. For

example, the code group XISV is transmitted as: "X-ray —Item—Sugar—Victor."

62. PRONUNCIATION OF NUMERALS. a. The following pronunciation of numerals is prescribed in telephone transmission:

Numeral	Spoken as—	Numeral	Spoken as—
0.....	Zero	5.....	Fi-yiv
1.....	Wun	6.....	Six
2.....	Too	7.....	Seven
3.....	Thuh-ree	8.....	Ate
4.....	Fo-wer	9.....	Niner

b. Numbers are transmitted as numerals or digits except in the case of an even hundred or thousand, in which case, the word hundred or thousand is used. Example:

Number	Spoken as—
44.....	Fo-wer Fo-wer
80.....	Ate zero
136.....	Wun thuh-ree six
500.....	Fi-yiv hun-dred
1478.....	Wun fo-wer seven ate
7000.....	Seven thow-zand
16000.....	Wun six thow-zand

c. When giving a telephone number to a switchboard operator, speak the directory name deliberately and distinctly, pausing between the name and first numeral. Pronounce each numeral separately, pausing slightly between numerals. Examples:

Directory name and number	Spoken as—
Table 44.....	Ta-ble, fo-wer, fo-wer.
Turkey 80.....	Tur-key, ate, zero.
Track 6100.....	Track, six, wun, hun-dred.

63. TRAFFIC DIAGRAM. a. General. A traffic diagram is a chart showing the number of telephone or teletypewriter channels existing between the switching centrals of a military wire system. Circuits connecting distant locals also are shown. Only those circuits available for traffic are shown. A single line indicates direct communication. A numeral placed on the line indicates the number of channels available, including simplex, phantom, and carrier circuits. The units, served by each switching central or distant local, are indicated by the telephone directory name, if used, or by an abbreviated designation. Unit designations are not included in traffic diagrams when signal security is jeopardized.

b. Preparation. A traffic diagram is prepared at each switching central by the wire chief or chief operator assisted by the operator on duty. In the case of extensive or elaborate systems, traffic diagrams may be prepared for all centrals by the signal officer in charge of the entire system. A traffic diagram of telephone chan-

Telephone Traffic Diagram 4th Infantry Division Corrected to 0001Q, 6 June 1944

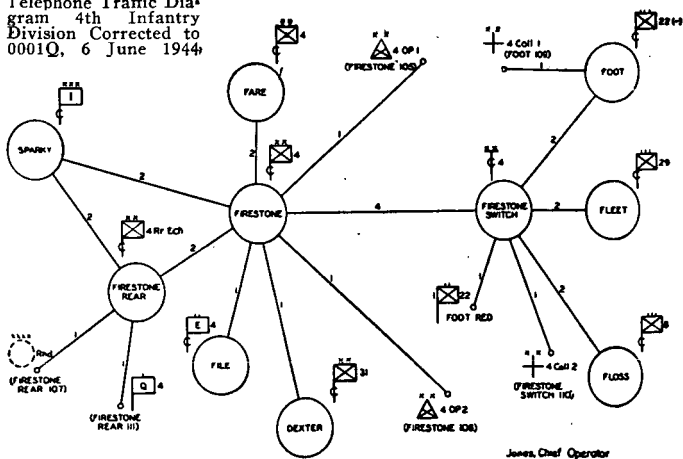

Figure 92. Example of telephone traffic diagram.

nels is designated as a telephone traffic diagram, while one showing teletypewriter channels is designated as a teletypewriter traffic diagram. An example of a telephone traffic diagram is shown in figure 92.

c. Purpose. The purpose of the traffic diagram is to indicate to the operator the most direct routing for a call to any other switching central in the system, and to show alternate routings in case the direct routing is busy or out of service. For this reason, the diagram often includes connecting systems of higher, lower, and adjacent units. It must be corrected continuously as changes occur, and expanded as new information is obtained.

64. TELEPHONE DIRECTORY. a. General. To simplify and expedite the operation of field telephone systems, particularly within divisions, a telephone directory is used. This directory consists of two parts: directory names and directory numbers; both being issued as one item of SOI.

b. Directory names. Telephone directory names are assigned to all organizations normally equipped with switchboards. These names are used even when a telephone is substituted for the organization's switchboard. Directory names also are assigned to telephone centrals not located at a command post. Within a division, all names begin with the same initial letter. When once assigned, these names are not changed except to avoid conflict with directory names of other units. Telephone directory names are assigned to speed up switchboard operation and have no security value. They must not be used to refer to units in messages or in conversations.

c. Directory numbers. Each organization, office, and installation not normally equipped with a switchboard is assigned a telephone directory number. To prevent confusion, the superior tactical commander should prescribe the same number for all similar offices through-

out his command. Directory numbers, when assigned, remain fixed. Within the limitations of the equipment, it is desirable that the switchboard jack number correspond to the directory number assigned to the organization, office, or installation.

d. Example of telephone directory.

Telephone central

4th Infantry Division	Firestone
4th Infantry Division, rear echelon	Firestone rear
8th Infantry Regiment	Floss
22d Infantry Regiment	Foot
29th Infantry Regiment	Fleet
4th Infantry Division Artillery	Fare
4th Engineer Battalion	File
31st Infantry Division	Dexter
I Corps	Sparky

Note. RED, WHITE, BLUE, or GREEN added to the telephone directory name of the regiment telephone central indicates the telephone central of the 1st, 2d, 3d, or 4th battalion, respectively.

Telephone directory numbers for officers and offices:

<i>Number</i>	<i>Title</i>
1.....	G-1 or S-1.
2.....	G-2 or S-2.
3.....	G-3 or S-3.
4.....	G-4 or S-4.
5.....	Chief of staff or executive officer.
6.....	Commanding officer.
7.....	Adjutant (division and higher units).
8.....	Ordnance officer.
9.....	Inspector.
10.....	Signal or communication officer.
11.....	Message center (incoming).
12.....	Message center (outcoming).
13.....	Aide-de-camp.
14.....	Air officer.
15.....	Engineer officer.

<i>Number</i>	<i>Title</i>
16	Surgeon or medical officer.
17	Judge advocate.
18	Finance officer.
19	Chaplain.
20	Postal officer.
21	Quartermaster (not supply officer).
22	Chief of artillery, or artillery officer.
23	Chemical or gas officer.
24	Liaison officer.
25	Division ammunition office.
26	Pigeon loft.
27	Provost marshal.
28	Radio station.
29	Reconnaissance officer.
30	Telegraph office.
31	Telephone wire chief, or trouble chief.
32	Veterinarian.
33	Public telephone.
34	Headquarters commandant.
35	Motor officer.
36	Antitank officer.
37	Special service officer.

Telephone directory numbers for units:

<i>Number</i>	<i>Unit</i>
101	4th Signal Company.
102	4th Medical Battalion.
103	Division advance landing field.
104	Headquarters company.
105	4th Division Observation Post No. 1.
106	4th Division Observation Post No. 2.
107	4th Division Railhead.
108	4th Division Motor Park.
109	4th Division Collecting Station No. 1.
110	4th Division Collecting Station No. 2.

<i>Number</i>	<i>Unit</i>
111.....	4th Quartermaster Company.
112.....	4th Division Clearing Station.
113.....	Military police platoon.

e. Purposes of directory. Directory names and numbers are not intended for secrecy, but rather for purposes of simplicity, accuracy, and speed in the handling of telephone calls. To fulfill its purposes, the telephone directory must be used consistently by all telephone switchboard operators and telephone users. However, operators should be instructed to put through calls regardless of how they may be placed. A copy of the telephone directory should be attached to each field switchboard and telephone in use. Many units have found it convenient to print the directory on a large tag and then attach this tag to the telephone. With this method, one side of the tag has the directory names for each headquarters, and the other side has names and numbers for all officers and offices.

f. In larger units. In larger units, such as corps and field armies, use of the telephone directory often becomes impracticable because it is difficult for the switchboard operator and others concerned to memorize the directory names of the many telephone centrals in the system. In such a system, the telephone directory designation of a telephone central may be the briefest, generally understandable, abbreviation of the designation of the organization whose headquarters is served by the central. Examples of such designations as spoken are: "First Army"; "Ninth Corps"; or "First Battalion, Seventh" for "First Battalion, Seventh Infantry" when no other organization designated by seven is served by the same system. Examples of a corps telephone directory and an army telephone directory are given in appendix I.

65. RECORDS. At each telephone central, the signal or communication officer prescribes what operational rec-

ords are to be kept. These records may include a station log and a test-and-trouble record (see pars. 66 and 80).

66. STATION LOG. a. The station log is kept by the switchboard operator on duty, under the supervision of the chief operator. A simple form for a station log (fig. 93) contains the following information:

- (1) Name of station involved.
- (2) Location, date, and hour at which station opened and closed.
- (3) Schedule of operators.
- (4) Drop and circuit number.
- (5) Time at which service opened and closed on each circuit.
- (6) Time of interruptions to service.
- (7) Remarks (nature of trouble, etc.).

b. At small telephone centrals this form is not required.

67. REPORTS TO MESSAGE CENTER. The operating personnel of a telephone central keep the message center continuously informed of wire communication available to other telephone centrals in the system. Lengthy interruptions or changes also are reported promptly to the message center.

STATION LOG

Station -----

Location	Opened		Closed	
	Date	Hour	Date	Hour

Schedule of operators					
Time	On	Off	Name	Time	
				On	Off

Drop No.	Circuit No.	Time service		Interruptions		Remarks
		Opened	Closed	Out	In	

Chief operator

Figure 93. Example of station log for telephone central.

FIELD TELEGRAPH AND TELETYPE- WRITER INSTALLATION AND OPERATION

68. TELEGRAPH AND TELETYPEWRITER CAPABILITIES. a. Telegraphy is one of the most rapid and accurate methods of transmitting messages electrically. Its value in a field wire system must never be overlooked. Failure to utilize telegraph channels will overburden seriously any field telephone system that may be installed during the normal time available, thus defeating the principal purpose of the telephone. By means of the simplex circuit, telegraph messages and telephone conversations may be transmitted simultaneously over the same circuit without mutual interference. The simplex circuit may be installed on every wire line, provided the units being served by the wire have the equipment necessary for operation. Although the ranges of telephone and telegraph instruments are limited, in general, by the same factors, most telegraph instruments have a much greater range than do telephone over a given circuit.

b. The teletypewriter is an instrument designed for interchanging printed messages between two or more stations. It is employed between higher headquarters in the same manner as the telegraph is employed between headquarters of units within a division. A military teletypewriter is illustrated in figure 94. For information regarding its employment, see FM 11-5. For

information about its installation and maintenance, see TM 11-353. For information about teletypewriter operation procedure, see FM 24-8.

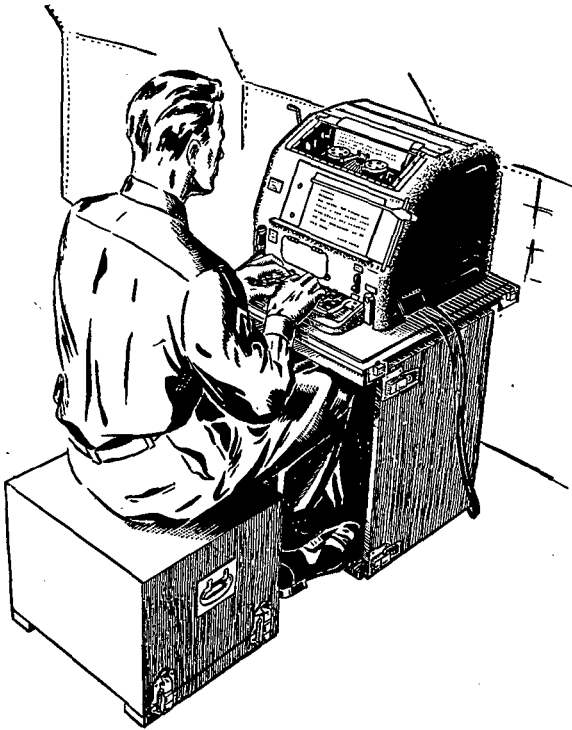

Figure 94. Military teletypewriter.

69. FIELD TELEGRAPH SETS. a. **General.** The telegraph sets in common use on field wire systems are Telegraph Sets TG-5-B, TG-5-A and TG-5. These sets differ from commercial telegraph equipment in that no sounders are used. Instead, the telegraph operators wear headphones and hear a sharp tone whenever local

or distant keys of telegraph sets on the circuit are depressed. Operation and procedure are, therefore, similar to those employed in break-in radiotelegraph.

b. Telegraph Set TG-5-B. (1) *General.* Telegraph Set TG-5-B is shown in figure 95, and is described completely in TM 11-351. Two Batteries BA-30 and one Battery BA-2 are required for operation. The line battery (Battery BA-2) is carried in the line battery cup, and Batteries BA-30 are held inside the battery compartment at the rear of the set. The large binding posts L_1 and L_2 are the line connections, both for simplex to ground and for a full metallic circuit. Basically, the circuits of the Telegraph Set TG-5-B can be di-



Figure 95. Telegraph Set TG-5-B.

vided into the *line circuit* and the *local circuit*. The line circuit comprises the 22.5-volt line battery, the telegraph key, and the line relay, all in series. The line circuit is connected by field wire lines to the same items of equipment in the distant stations comprising the net. The telegraph keys have three terminals, and the circuits are so designated that, when the key is up, the circuit is completed through the back contact. Depressing any key in the telegraph net places a 22.5-volt battery in series with the line, causing all line relays to operate. The local circuit has two functions: it can operate as an alarm, in which case ringing of the bell in the telegraph set indicates that a station in the net is beginning operation; or it can key a tone from an interrupter (telephone receiver direct-coupled to a carbon-button microphone) for communication by International Morse characters.

(2) *Installation*. Remove the telegraph set from its carrying case, open the front compartment, and remove the head set and cord. Open the local battery compartment, using a screw driver to turn the slot on the catch to a vertical position. Place two fresh Batteries BA-30 in the local battery compartment, making certain that the case of one battery makes contact with the coiled spring, and that the cap of the other battery makes firm contact with the metal spring plate. (The metal spring plate and the contact between batteries should be clean.) Close and lock the door of the local battery compartment. Should the alarm bell ring, open the box and increase the relay armature spring tension by moving the ADJUST pointer to a higher number until the ringing stops. Adjust the key until its feel is suitable to the touch. Make sure that the front contacts are open when the key is released, otherwise, the line battery will be short-circuited and the key contacts may be ruined. Connect the red lead of the 22.5-volt Battery BA-2 to the small plus (+) binding post, and the black

lead to the 22-volt negative (—22) binding post. Connect the telegraph lines (or telegraph leg of the repeating coil and ground, of a simplex circuit) to L_1 and L_2 .

(3) *Adjustment and test.* (a) *Alarm circuit.* Short circuit the binding posts L_1 and L_2 . Depressing the telegraph key should start the alarm bell ringing. If the alarm fails to ring and the battery is known to be serviceable and properly connected, decrease the ADJUST pointer setting one notch at a time until the bell rings when the key is depressed.

(b) *Local tone circuit.* Insert the plug in the jack at the lower right hand corner of the set. This closes the local battery circuit to the interrupter, and a faint continuous hum will be heard indicating that the interrupter is working. Depress the telegraph key with the line binding posts still short-circuited; a 1,000-cycle-per-second tone should be heard clearly. The set must be in an upright position as this is necessary for the best operation of the interrupter. Now the short circuit should be removed and the relay adjusted for operation in the telegraph circuit.

(c) *Line relay adjustment.* Considerable care is required to adjust the line relay for satisfactory functioning on circuits of varying line length and ground connection resistance. When the ADJUST pointer is at zero, the armature spring tension is at its minimum and the relay will operate with small line currents. Because of the characteristics of the relay, this adjustment will not be satisfactory for larger currents; the spring adjustment will be too weak to pull the armature away from the core face fast enough after such a larger current has ceased to flow. The adjustment consists of setting the spring tension to obtain the proper relationship between the magnetic pull when current flows in the relay winding and the pull of the spring. For all line conditions, the ADJUST pointer should be moved to the position where the relay contacts will

open and close as sharply as possible. The relay is known to be properly adjusted when the tone in the telephone head set clearly and accurately follows the telegraph keying, and shows no tendency to lag or stick on dashes or to chirp on dots.

(4) *Operating the set.* (a) *Transmitting.* Use the key as in any other telegraphic circuit. The line battery furnishes current only when the telegraph key is depressed. The transmission is monitored continuously.

(b) *Receiving.* With the relay properly adjusted, the signals received from the distant station are as loud as the local signals, since the howler circuit furnishes the tone for both.

(c) *Break-in.* If it is desired to break in on the transmission of the distant operator, operate the telegraph key of the local set and make long dashes. The distant operator will immediately be aware of the break-in signals and will stand by for the local operator's transmission.

(d) *Continuous operation.* If the set is to be operated continuously, keep the plug in the jack. Signals then are received only in the head set which must be worn constantly in order not to miss a call. Such operation causes a continuous drain on the local batteries.

(e) *Stand-by operation.* With the plug withdrawn from the jack, the hummer is inoperative, and incoming signals operate the alarm bell. As a result, no battery drain exists under such conditions except when the alarm is ringing. This is desirable for stand-by operation.

(5) *Care of Telegraph Set TG-5-B.* Keep Telegraph Set TG-5-B clean and dry, being particularly careful to blow out all dust or dirt picked up in the field. Keep all connections tight, and inspect the wiring for broken leads. The local battery coiled-spring and plate contacts should be clean and bright. The telegraph key contacts and the relay contacts also should be kept clean. This is done by placing a small piece of glazed paper, that

has been dipped in carbon tetrachloride, between the contacts and then withdrawing the paper while applying a slight pressure on the contacts. Repeat with a piece of dry paper, always taking pains to prevent lint from accumulating on the contacts. Should the contacts be pitted, it may be necessary to use the burnisher furnished with each set. This is used by placing the thin blade between the contacts and withdrawing it with a slight pressure on the contacts. Particular care must be taken, when burnishing the relay contacts, not to spread or bend the springs apart, since this will cause faulty operation. As with all other apparatus, remove the batteries from the telegraph set if it is not to be kept in continuous service.

c. **Telegraph Sets TG-5-A and TG-5.** Telegraph Sets TG-5-A and TG-5 are described in TM 11-351. Their installation and operation are similar to those of Telegraph Set TG-5-B, except that the line relay has both a spring tension and an air gap adjustment.

70. FIELD TELETYPEWRITER SETS. The teletypewriters in common use on field wire systems are Teletypewriter Sets EE-97 and EE-98. Each of these is equipped to function as a complete sending and receiving teletypewriter station, including local and distant line current supply. Teletypewriter Set EE-97 is intended for locations where no commercial power is available, or where it may not be available at all times. Teletypewriter Set EE-98 is intended for locations where 115-volt, a-c or d-c commercial power is available at all times. For detailed description of these sets, see TM 11-354.

71. TELETYPEWRITER CENTRAL (Ttc). a. The usefulness of the teletypewriter is increased tremendously by the teletypewriter central, abbreviated Ttc. The abbreviation for a commercial teletypewriter exchange, to

which military operated teletypewriters may be connected in certain situations, is TWX. The switchboard for a small teletypewriter switching central is quite simi-

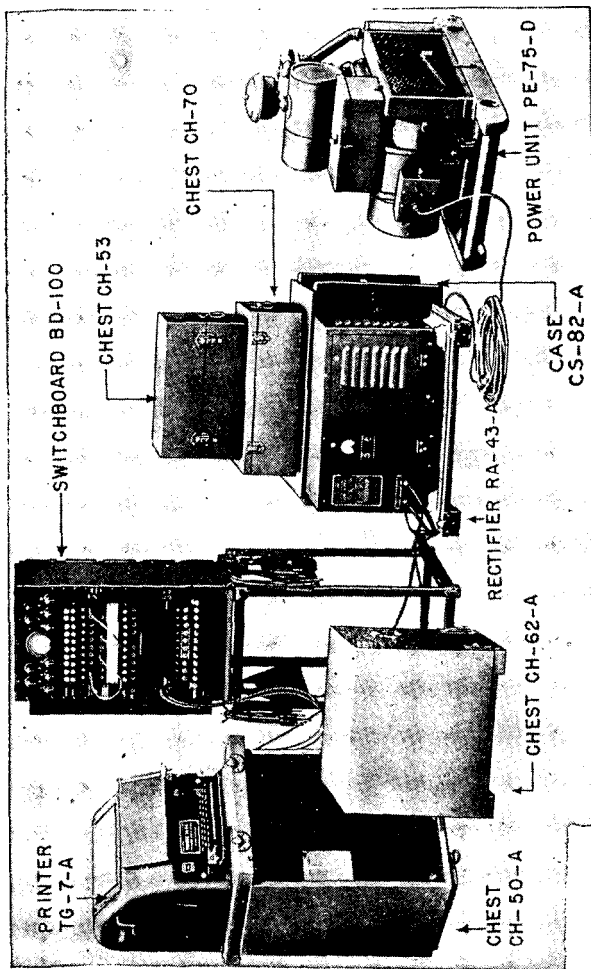

Figure 96. Telegraph Central Office Set TC-3 set up for operation.

lar to a telephone switchboard, except that the operator communicates by teletypewriter. A reperforator often may be used in place of a switchboard at a teletypewriter central, or the messages may be relayed manually by re-typing. The teletypewriter central provides great flexibility in switching between teletypewriter stations; and such connections as two-way station-to-station, conference, and broadcast can be quickly set up. In addition to the provisions for a stand-by and automatic starting and stopping of distant teletypewriters for receiving messages while unattended, the advantages of the system include instantaneous transmission and immediate acknowledgement of receipt typed on the message itself.

b. The Telegraph Central Office Set TC-3 (fig. 96) is an example of a teletypewriter switching central. This set is transportable, and can be installed in any headquarters requiring the use of a teletypewriter switching central with a capacity of 10 teletypewriter lines. Each switchboard BD-100 provides switching and repeating facilities for neutral operating of its 10 teletypewriter lines. Provision is made for quickly connecting any teletypewriter line or trunk to any other line or trunk, or group of lines or trunks, connected to the switchboard. An operator's teletypewriter enables him to answer calls and supervise connections. For complete information on Telegraph Central Office Set TC-3, see TM 11-358.

c. Teletypewriter central personnel can expedite communication by the preparation and use of traffic diagrams, prepared in a manner similar to telephone traffic diagrams (see par. 63).

72. CIRCUITS. Usually telegraph and teletypewriter circuits used in field wire systems are obtained by simplexing existing telephone circuits (see par. 52). Where the tactical situation is such that hostile interception is unlikely and proper operating precautions are taken, the

earth may be used as a return circuit. The telegraph terminal on the repeating coil or switchboard at each end of the circuit is connected to one line binding post of the telegraphic instrument. This is the telegraph leg, and may be either a single conductor or a twisted pair of field wires with both conductors in parallel. The other line binding post of the telegraphic set at a terminal station is grounded. Where a good ground connection cannot be obtained (par. 73), and a second telephone circuit can be simplexed, a phantom circuit may be used.

73. GROUND CONNECTION. A low-resistance ground connection usually is necessary for each terminal station, not only to insure sufficient operating current, but also to prevent interference with neighboring telegraph circuits. It is almost always possible to obtain a good ground by proceeding as follows:

a. Drive a metal ground rod about two feet long well into moist ground. Use a longer rod if one is necessary and available. Usually the ground near roots of a shrub, cactus, or other vegetation is moist. The ground rod, or a long spike, may be driven into the roots proper. If only dry ground is available, wet it thoroughly and pack it down around the rod.

b. Use a separate ground for each telegraph set or other equipment and keep separate grounds at least 15 feet apart.

c. Use two or three ground rods connected in parallel and at least 10 feet apart if one ground rod will not suffice. No appreciable reduction in resistance will be realized by use of more than three ground rods.

d. Keep the wire leading from the set to the ground rod reasonably short, but do not hesitate to use a wire several hundred yards long if necessary to reach moist ground, such as a stream bed.

c. Ground rods should be clean and free from paint and grease.

74. BRIDGING SIMPLEXED CIRCUITS AROUND A SWITCHBOARD. A telephone circuit that is to be simplexed for telegraph may pass through an intermediate telephone central at which no telegraph set is to be located. In such a case, it is necessary to make the simplex circuit continuous by bridging it around the telephone switchboard by means of repeating coils.

75. TELEGRAPH WAY STATION. Intermediate stations located between the terminal stations on a telegraph circuit are called the telegraph way stations. The connections which may be made at the way station are shown in paragraph 11.

76. ESTABLISHING TELEGRAPH COMMUNICATION. a. On long telegraph circuits, where good ground connections cannot be obtained, some difficulty may be experienced in establishing communication since the operator at one station may not know when the distant operator is on the line and that he is attempting to transmit or receive signals. If telephone communication with the distant operator is possible, one operator should call the other by telephone and indicate that he is ready to operate, and that he will attempt to establish communication by telegraph. The temporary loan of a telephone for this purpose will pay dividends. The unit signal or communication officer should prescribe a definite procedure.

b. When no other means of communication is available, it will be necessary for each operator to adjust his instrument for most sensitive operation, connect it to the line, and alternately listen and transmit until he succeeds in communicating with the distant operator. A definite time should be prescribed by the unit signal

or communication officer for beginning telegraphic communication to facilitate establishing the net.

77. TELEGRAPH REPEATER EQUIPMENT. In many situations, telegraph communication is limited or is unsatisfactory because of the long distances involved and the type of wire facilities available. By the proper use of telegraph repeater equipment, such facilities may be utilized to give satisfactory service.

a. **Repeater Set TC-18.** Repeater Set TC-18 consists primarily of Repeater TG-30, which is a telegraph terminal repeater used for transmitting to and receiving from another Repeater TG-30, or its equivalent. The repeater is designed for operation on field wire line simplex circuits, or open wire circuits composited with ground return. The equipment is portable, weighing 130 pounds when inclosed completely in a weatherproof wooden carrying case. For further information on this equipment refer to TM 11-2004.

b. **Repeater Set TC-19.** Repeater Set TC-19 consists primarily of one Repeater TG-31, which is an intermediate d-c telegraph repeater. It is designed for unattended operation at an intermediate location between terminal repeaters, such as Repeater TG-30 or its equivalent. The equipment may be used on teletypewriter circuits operating at speeds up to 66 words per minute over field wire lines simplex, or open wire lines either composited or simplex. The complete unit weighs 130 pounds. Further information on the installation, operation and maintenance of Repeater Set TC-19 may be obtained by referring to TM 11-2005.

78. TELEGRAPH OPERATING PROCEDURE AND RECORDS. Station records and operating procedure for military manual field telegraph sets are generally the same as for radio, including the use of the International Morse characters. (See FM 24-6 and TM 11-454.)

CHAPTER 5

MAINTENANCE OF FIELD WIRE SYSTEMS

79. GENERAL. Maintenance of a field wire system includes the prevention, detection, and correction of trouble in the system. The maintenance of wire network during tactical operations is an important task since uninterrupted telephone service is so essential to a successful air or ground operation. Maintenance problems will develop that can be overcome only by careful planning and constant effort. Careful selection of initial wire routes and standard installation will assist greatly in overcoming these difficulties and reducing the maintenance problem. Personnel assigned to maintenance and patrol activities should be selected carefully and should be the best qualified available for this work.

a. Preventive measures. The following actions will assist in keeping troubles at a minimum:

(1) Conference between signal and communication officers, with reference to the location of wire lines.

(2) Wire lines should be routed and switching centrals and stations located to avoid hostile artillery fire, land mines, and aerial bombardment as far as practicable. Care should be taken at all times to protect lines and equipment from accidental injury by friendly troops and traffic.

(3) Continuous patrolling of the wire lines with two or three man teams to make minor repairs or rearrangements of wire conditions which ultimately might cause trouble.

(4) Training of all operating and using personnel in the proper use and care of wire equipment.

(5) Careful handling of wire equipment and its protection from moisture while in storage, in transit, and after it is installed.

b. Trouble on wire lines. Trouble that occurs in field wire systems is of two classes: that which causes an *interruption to service*, and that which is located and cleared *before* an interruption to service occurs. Most trouble may be kept in the latter class by an alert maintenance crew making proper routine tests. When trouble occurs, it is located and cleared as soon as possible by methodical locating procedure, and proper repair or replacement of equipment. All trouble, whether detected by operating and maintenance personnel or reported by users, is recorded and followed up until cleared. Clearing of trouble on wire lines is facilitated by the establishment of test points and test stations at important junctions and at points near where trouble is anticipated.

80. ROUTINE TESTS. a. Frequency. The frequency with which routine tests of circuits and equipment should be made varies, and is determined by the nature and importance of the circuits, type of equipment and its manner of installation, amount of traffic being handled, and amount of trouble being experienced. The frequency of these tests is prescribed by the signal or communication officer. All local and trunk circuits and their operating equipment are included in these tests. In general, circuits that are kept busy do not require as frequent routine tests as those that are used but seldom. Communication is never interrupted to make a routine test, since a busy circuit obviously indicates that it is not in trouble. Circuits that have been busy and suddenly become idle are checked by the switchboard operator at the first opportunity.

b. Trunk circuits. Ordinarily routine tests of trunk

circuits are made by the wire chief, although they may be made by the switchboard operator, if making the tests does not interfere with the prompt handling of traffic. The tests include checks to see that each switchboard can be signaled from the command post switchboard, and that the voice transmission in each direction over the circuits is clear and satisfactory.

c. Local circuits. Ordinarily the routine tests of local circuits are made by sending a maintenance man to the local telephone to test the circuit back to the wire chief or switchboard operator. The test includes checking to see if the switchboard can be signaled from the telephone, and vice versa, and for satisfactory voice transmission in both directions over the circuit. In cases where it is impracticable to send a man to the local telephone, as might happen in the case of a long circuit, the user is called and requested to make the test. Ordinarily, however, users are not requested to make routine tests of local circuits.

d. Keeping records. A record of installation time, tests made, and troubles found or reported on trunk circuits is kept by the wire chief at each telephone central on a form like the one illustrated in figure 97. Such a record should include the following information:

- (1) Directory name of station.
- (2) Location, date, and hour of opening and closing.
- (3) Schedule of assistant wire chiefs.
- (4) Drop and circuit numbers.
- (5) Time at which lines were connected to switchboard.
- (6) Time at which service was opened on each line.
- (7) Time of interruptions to service, with notation of personnel clearing trouble.
- (8) Time service terminated on particular line.
- (9) Remarks (nature of trouble, etc.).

INSTALLATION AND TROUBLE RECORD

Station.....

Location		Opened		Closed		
		Date	Hour	Date	Hour	
• Schedule of ass't wire chiefs						
Circuit No.	Drop No.	Time		Name		Name
		On	Off			
				Time		Remarks, nature of trouble (etc.)
				On	Off	
				Interruptions		Time service closed
				Time out	Time in	
				Time service opened	Cld. by	
				Time line connected		

Wire chief

Figure 97. Example of installation and trouble record.

81. CIRCUIT TROUBLES. a. Character. Trouble on a field wire circuit is indicated when it is impossible to signal or be signaled, when it is impossible to hear or to be heard, when the transmission is weak, or when noise on the circuit or crosstalk from other circuits interferes with conversation. A knowledge of the various troubles and the manner in which they affect transmission will aid materially in localizing the troubles when they occur.

b. Cause. Trouble may occur either in the line wire itself or in the operating equipment attached to it. Usually the cause will be found to be the result of an *open*, a *short*, a *ground*, or a *cross*, or any combination of these faults at one or more points in the circuit.

(1) The open circuit, or *open*, is a break or cut in the conductor, either on one or both sides of the circuit.

(2) The short circuit, or *short*, is caused by electrical contact between the two conductors of a circuit. It may be the result of bruised or stripped insulation, that either permits the bare wires to touch each other or permits electricity to be conducted from one to the other when wet.

(3) The grounded circuit, or *ground*, occurs when there is an electrical path to earth from one or both conductors of the circuit. It also may be the result of bruised or stripped insulation or a poorly taped splice if the splice is lying on the ground, or in the water. The effects of grounds will be most pronounced in wet or damp weather.

(4) The crossed circuit, or *cross*, is caused by electrical contact between conductors of two adjacent circuits, and is in reality a short circuit between a conductor of one circuit and a conductor of another.

c. Effects on telephone transmission. (1) An open will interrupt telephone communication completely. However, a partial open, such as results from a poorly made splice or a loose contact, introduces a high re-

sistance in the circuit. It may not destroy communication completely, but transmission becomes weak and often noisy.

(2) A low resistance short will interrupt telephone communication completely. A partial (or high resistance) short will result in weakened transmission and may affect, or prevent, ringing.

(3) A ground on both sides of a circuit will produce an effect similar to that of a short. Usually ground on only one side of a circuit will not interrupt telephone communication, but may produce hum or noise in the circuit.

(4) A cross is likely to result in crosstalk or interference between the two circuits involved, and may or may not be sufficient to render the separate conversations unintelligible.

d. Effects on simplex telegraph operation. It will be observed that a simplex telegraph channel may continue to operate under certain trouble conditions, even though the physical circuit on which it is superimposed is inoperative for telephone communication. This emphasizes again the value of the simplex telegraph channel. The simplex telegraph circuit will work, or may be made to work, by the addition of one or more batteries in the case of Telegraph Sets TG-5, TG-5-A, or TG-5-B, even though one side of the physical circuit is open. A short on the physical circuit will not affect the telegraph channel adversely. An accidental ground on one or both sides of the physical circuit generally will not render the telegraph channel inoperative, unless the ground is of unusually low resistance. A cross is not likely to interfere with the telegraph channel unless both of the circuits involved in the cross are simplex, and even then it may not render the telegraph channels inoperative.

82. EQUIPMENT FOR TESTING. The nature of the trouble on a field wire circuit or in operating equip-

ment can be determined with any of the following equipment in the manner described:

a. Field telephones. Any field telephone may be used for testing line or equipment circuits. For convenience in making tests, the telephone is equipped with a pair of test leads made of lamp cord, field wire, or other flexible twisted pair wire about 3 feet in length. A test clip is soldered to one end of each conductor, and, if stranded wire is used, the other end which is to be connected to the line terminal of the telephone is soldered lightly to hold the strands together and prevent accidental short circuits at the telephone terminals. The following tests may be made:

(1) *Test for an open.* Connect the ends of the circuit to the line terminals of the test telephone, and turn the generator crank rapidly. If the generator crank turns freely without any drag on it, the circuit probably is open.

(2) *Test for a short.* If the generator turns quite hard, as if a drag had been placed on it, with the telephone connected as in the preceding test, the circuit is probably short circuited or grounded on both sides.

(3) *Test for a ground.* Connect one side of the circuit to one line terminal of the telephone, and connect the other line terminal of the telephone to ground. If there is a ground on that side of the circuit, the generator will turn hard, as in the case of a short. Test the other side of the circuit in a similar manner.

(4) *Test for a cross.* Connect one side of the circuit to one line terminal of the telephone and connect the other line terminal of the telephone to the conductor with which the circuit may be crossed. If there is a cross, the generator will turn hard, as in the case of a short circuit. Test each side of the circuit in a similar manner with any conductor with which it might be crossed.

b. Test Sets EE-65-A and EE-65. Test Sets EE-65-A

and EE-65 are compact wire chief's testing equipment for use in the field or in central office installations. Test Set EE-65-A is illustrated in figure 98. In addition to equipment for ringing and talking on field wire systems, both test sets have provisions for the usual measurements required for analysis of faulty line operation. These tests include checks for continuity, opens, shorts, grounds, and other more specialized applications, such as determination of line capacitance and leakage. The principal differences between the two test sets are that Test Set EE-65-A has a more sensitive voltmeter, and there is no telephone handset included with the instrument. For a complete description and circuit diagrams of Test Sets EE-65-A and EE-65, see TM 11-361.

c. **Voltmeter and battery (fig. 99).** A simple arrangement for testing equipment circuits consists of a voltmeter and battery connected in series and equipped with

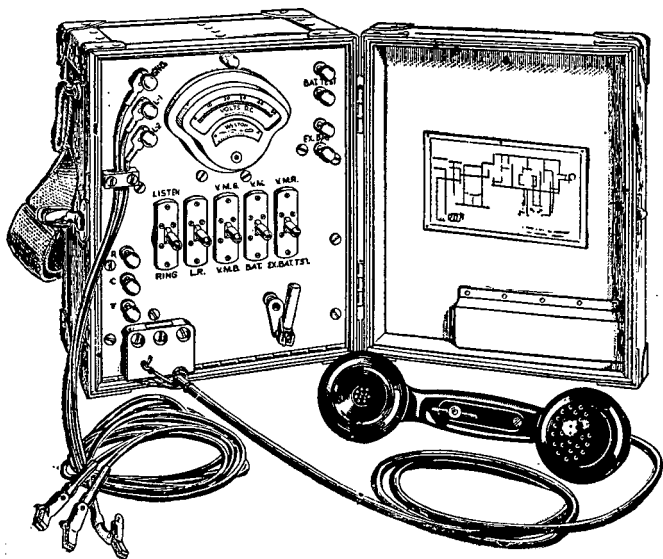

Figure 98. Test Set EE-65-A.

wire leads. The terminals of the wire leads may be fitted either with test clips or short lengths of stiff copper wire for convenience in making contacts with the equipment circuits. This apparatus is suitable for making the following tests:

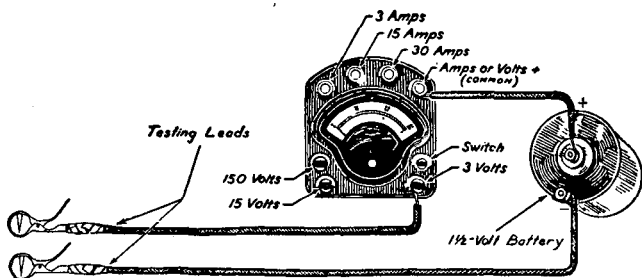

Figure 99. Voltmeter and battery for use in testing circuits.

(1) *Test for complete circuit.* Connect the test leads to the ends of the circuit to be tested. If the circuit is complete, the voltmeter needle will indicate a reading.

(2) *Test for an open.* Connect the test leads to the ends of the circuit to be tested. If the circuit is open, the voltmeter needle will not indicate a reading.

(3) *Test for a short.* Connect the test leads to the ends of the circuit to be tested. Open the other end of the circuit. If a short circuit exists, the results noted will be the same as for a complete circuit, as in (1) above.

(4) *Test for a ground.* Connect one test lead to the circuit to be tested. Connect the other test lead to ground. If the circuit is grounded, the results noted will be the same as for a complete circuit.

(5) *Test for a cross.* Connect one test lead to the circuit to be tested. Connect the other test lead to the circuit with which the circuit to be tested is believed to

be crossed. If one is crossed with the other, the results noted will be the same as for a complete circuit.

d. Receiver and battery (fig. 100). A telephone receiver, connected in series with a battery and fitted with leads, may be used for testing. The terminals of the test leads may be either test clips or short lengths of stiff copper wire. The apparatus is suitable for making the tests outlined for the voltmeter and battery in c above. However, a click in the receiver instead of reading indicates a complete circuit. A failure to obtain the distinct click on successive attempts to complete the circuit indicates an open circuit. Considerable care must be exercised when making this test to distinguish between the receiver clicks of a complete circuit and an open circuit. On a succession of tests if all clicks are of the same intensity the circuit is complete. On an open circuit the first click, caused by the capacity affect, may be rather loud; however, successive tests will produce clicks of greatly reduced intensity indicating the circuit is open.

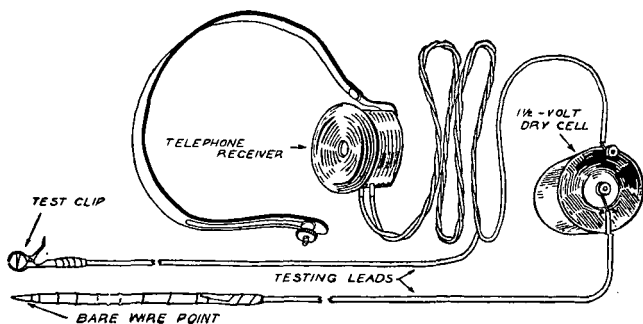

Figure 100. Receiver and battery connected for use in testing circuits.

e. Test Set I-49. Test Set I-49 is a portable dial-decade Wheatstone bridge using a self contained $4\frac{1}{2}$ -volt battery. It is used for measuring resistance and for locating shorts, crosses, and grounds by the Varley or Mur-

ray loop-test methods. The cover of this test set contains complete instructions for its use.

f. Test Set TS-26. Test Set TS-26 is a volt-ohmmeter, equipped with test leads, a 315,000-ohm resistor, a reversing switch, and a 45-volt battery. The test set can be used to measure insulation and conductor resistance and to detect grounds, crosses, shorts, and opens. This testing equipment is very effective for trouble locations on short-range circuits and may be improvised from any available volt-ohmmeter when an issued set is not available.

g. Test Set TS-27 (combination-bridge). Test Set TS-27 is a portable fault-locating set with a d-c bridge for measuring conductor and insulation resistance and for locating grounds, crosses, and shorts. An a-c bridge is provided for measurement of capacitance and the location of opens. Potential for d-c bridge measurements is supplied by two Batteries BA-59. A 20-cycle alternating current for a-c measurements is supplied by a vacuum-tube oscillator, for which the same Batteries BA-59 supply the plate voltage. A Battery BA-15-A supplies the filament voltage for the vacuum-tube oscillator. Complete operating instructions and calibration-curve sheets for different types of wire and cable are included in the test set cover.

h. Test Boards. Test boards may be improvised from any of the above mentioned testing equipment and a small switchboard, such as Switchboards BD-71, BD-72 or SB-5/PT. The arrangement of the equipment can be similar to that described for the construction center (par. 27), or it can be made more elaborate, depending on the needs of the unit and the equipment available.

83. ORGANIZATION AND OPERATION OF A MAINTENANCE POOL.

a. Purpose. Experience during field operations has shown that it is often practicable to establish a maintenance pool to facilitate dis-

patching of maintenance crews, and to expedite maintenance operations. A maintenance pool, from which maintenance crews can be sent out to clear trouble quickly on the wire system, should be at a central location. Normally, two or more maintenance crews with suitable equipment are assigned to duty at the pool. The wire chief, usually located at the construction center, dispatches the crews by telephone as they are needed. (See c below.)

b. Location. (1) Normally, a suitable location for a maintenance pool can be found near the construction center, but far enough away from the command post area so that maintenance crews will not interfere with, nor be impeded by, normal traffic into or out of the command post. It should be an area large enough to permit dispersion of maintenance vehicles, and allow personnel to dig slit trenches or provide themselves with other suitable individual protection. If the location selected does not provide adequate concealment from observation for vehicles and personnel, camouflage should be used.

(2) In air force communication networks, it is usually necessary to station repair teams with a vehicle at the outlying airdromes. These teams work in conjunction with the other team stationed throughout the network in clearing reported troubles on the trunk lines. In addition, test stations are established as explained in paragraph 85.

c. Operations. At all times during operations one maintenance crew must be on the alert and ready to move out to locate and clear trouble on the wire system, or perform any other assignment within its capabilities. Upon being dispatched, the alert crew must awaken the next crew on call in order to provide continuous and prompt availability of maintenance personnel. Crews may be dispatched in rotation or in any other sequence that assures equal distribution of work.

In scheduling the duty of maintenance crews provision must be made for regular meals and rest periods, so far as possible, without decreasing the efficiency of operations. Construction crews, and any other personnel temporarily assigned to wire maintenance duty, may be stationed at and dispatched from the maintenance pool in the same manner as the regular maintenance crews. Wherever possible, trouble on a line should be cleared by the team that constructed the line.

84. LOCATING AND CLEARING TROUBLE. a.
General localizing of trouble. When trouble is detected or reported on a circuit, the first step is to determine whether it is in the line wire itself or in the operating equipment. If tests made from the terminal equipment toward the switchboard show no trouble in the operating equipment when the line wire is cleared from the terminal equipment at the terminal strip, the trouble is either in the line wire itself or in the operating equipment at the distant end. This is verified by connecting the test equipment to the line, and testing toward the distant end of the circuit. Trouble on a trunk circuit may be localized still further, providing an additional good circuit is available, by requesting the wire chief at the distant end to clear the faulty circuit from the operating equipment at that end. Then the circuit is tested again for an open with the distant ends of the circuit open, and for a complete circuit with the distant ends of the circuit connected together. If the trouble is in the line wire itself, it will be revealed during the tests. If the tests show the line wire to be good, the trouble is in the operating equipment at the distant end, and the wire chief there is notified and requested to clear the trouble and reconnect the circuit.

Caution: Always listen in on a circuit to determine whether or not it is in use before opening the line for

tests. Never open up a circuit on which someone is talking.

b. Short local circuit in trouble. If, upon making the first test (par. 84a) at the terminal strips, the trouble is found to be toward the user's telephone, the circuit is reconnected and a trouble man dispatched to the user's instrument, with a serviceable telephone. On his way, he inspects the circuit for visible sources of trouble, and repairs any that he finds. He then makes a ringing and talking test with the user's telephone. If he cannot signal the operator with it, he replaces the local instrument with his own instrument and repeats the test. If he can now signal and converse with the operator, the trouble was in the local telephone, which is either repaired or replaced. If he cannot signal the operator, the trouble is probably in the local line circuit. He first tests for a short and an open circuit, then tests for a grounded circuit, and, if applicable, tests for a cross with another circuit. If trouble is located in the line wire, he works back toward the switching central, making a careful inspection of the line wire and paying particular attention to splices and other possibly defective points over its entire length. If the fault is located, he repairs it and notifies the user that the service is again available. If careful inspection does not disclose the fault, time may be saved by running a new circuit. This circuit is connected into the switchboard, the local telephone connected at the end of the circuit, and the new installation tested.

c. Trunk circuit or long local circuit in trouble. (1) If the tests described in paragraph 82a determine that the trouble is in the line wire of a trunk circuit or in a long local circuit, the wire chief determines as accurately as his instruments permit the nature and approximate location of the trouble. This will facilitate

the testing and shorten materially the time required to locate and clear the trouble.

(2) The circuit in question is connected to a test telephone at the switchboard terminal strip, or left connected into the switchboard if there is not sufficient maintenance personnel available to man the test telephone. A lineman is sent out on the line with a test telephone to test methodically from various points back to the man at the switchboard terminal strip, or to the switchboard operator. The lineman should take with him a telephone equipped with test clips, TE-33, friction tape, rubber tape, siezing wire, tags, TE-21 (if needed) and a 50-foot coil of the same type wire used in the faulty line. Starting from the switchboard terminal strip, he carefully examines the circuit as he proceeds, paying particular attention to the insulation, splices, underground and overhead road crossings, and places where the wire has been passed over or pulled out of place by traffic. Fouled insulation, poor splices, and other evidences of possible trouble are repaired, and the circuit is tested in order to determine whether the trouble has been cleared. If no obvious troubles are found, the lineman bridges his telephone across the circuit at intervals and tests.

Caution: Never use test clips with steel points to puncture the insulation on Wire W-143, as they will cause either one or both sides of the line to be grounded to the stabilizing shield around the wire.

(3) In testing the defective circuit for an open, the lineman connects the test telephone across the circuit without opening it. If testing for a ground or a short, the lineman opens the circuit and then tests in both directions. Before opening the circuit, however, he connects his telephone to the line with the test clips, and attempts to communicate in either direction since the trouble may have been cleared in the meantime by other personnel. In case it is necessary to open the

circuit, it is opened at a splice or at a test point if practicable. After making each test, the circuit is reconditioned by taping wherever a test clip has been connected to it, or by splicing and taping wherever the wire was cut.

(4) Upon making each test, the lineman can determine whether the circuit is good between his location and the telephone central by trying to ring and talk to the man at the switchboard terminal strip or the operator. If a test toward his own telephone central is successful, the fault still lies beyond in the direction of the distant telephone central, and the lineman continues to work in that direction. If he is unsuccessful in reaching his own telephone central during any test, he has passed the fault and therefore works back over the circuit, cutting the distance between successive tests in half. By following this procedure, the fault is located between two points a short distance apart. Then this section of the line is inspected carefully until the actual fault is located. The fault is repaired as required; by splicing, by cutting out and replacing the faulty section, or by taping.

(5) A defective circuit may have more than one fault. Therefore, it is essential that the lineman, after clearing each case of trouble, test the circuit in both directions to determine whether it is in order. If trouble still exists, he continues his inspection until all trouble has been located and cleared.

(6) There is considerable time consumed in splicing a circuit after each test for a short or ground, and this will delay seriously the ultimate locating of a fault if such tests are made at too frequent intervals along the circuit when first starting out. A visual inspection of the circuit by the lineman, as he progresses along its route, frequently will disclose the fault. A knowledge of the geographic location of a circuit will aid the wire chief in predicting the probable location of a

fault, after having determined its nature. The wire chief may direct the lineman to make tests from the vicinity of such points, or he may specify the approximate interval for making tests. A good rule is: After passing any portion of the circuit, that can not be inspected visually, connect the telephone and test.

d. Directed and undirected sectionalizing and hunting. The procedure described in c above is *undirected sectionalizing and hunting*. *Directed sectionalizing* is similar to undirected, except that whenever a test is made it is possible to determine not only the direction of the trouble from the testing point, but also the approximate distance from the point. An example of directed sectionalizing would be the location of a ground by means of the combination-bridge Test Set TS-27. *Directed hunting* is a method of finding a fault, that has been sectionalized between two points, by means of electrical-exploring apparatus. For example, in locating a short circuit between two points, an oscillator may be connected at one of the points so as to impress a tone on the line. Then a lineman walks along the line with a pick-up coil, amplifier, and telephone receiver, and listens to determine the point at which the tone disappears. The directed method of sectionalizing saves considerable time by eliminating immediately a large portion of the line from suspicion. In the majority of cases, one, or at most, two steps of directed sectionalizing will narrow down the location of the trouble so that the actual location can be determined readily with a minimum of hunting.

e. Removing trouble. In repairing a circuit in the field, speed in restoring service comes first, and proper technique in splicing next. When repairing a break in a line, communication is restored immediately by completing the square knot in each wire. Then while the bare wires are kept separated to prevent a short circuit, the splice is completed and taped. A valuable

addition to a lineman's equipment consists of two short pieces of wire, about 3 feet in length, with test clips on each end. These jumper wires are used to bridge a break during the construction of a splice, thus keeping the circuit in operation. When using jumper wires, care is taken that a short circuit is not caused while splicing. In locating trouble, linemen are sent out from each end of the circuit and work toward each other. The wire chiefs at both ends are responsible that it is cleared, regardless of where the trouble was first discovered. In addition to knife, pliers, tape, and test telephone, each lineman carries a 50-foot coil of field wire with which to repair defective sections.

f. Trouble in local operating equipment. If the trouble originally was found to be toward the operating equipment at the central, it may be localized by opening the circuit at various places, such as at line terminals, fuses, protectors, etc., and the tests repeated. Terminal strips and connections are inspected carefully for shorts, opens, and crosses. If the trouble is in the equipment itself, it can be located by a rigid system of testing such as prescribed for that specific piece of equipment, or in the Technical Manuals relating to the equipment. In the case of a faulty unit in a switchboard, its use should be discontinued and the circuit transferred to a spare unit until repair or replacement can be made.

85. OPERATION OF TEST STATIONS. **a. Personnel.** The personnel at a test station may consist of one or more linemen, as the situation requires. When the talking range will not be affected adversely, a test telephone may be kept bridged across a circuit; usually the lowest numbered telephone circuit passing through the test station, or a special circuit ending at the test station may be reserved temporarily for test purposes. The personnel on duty at the test station are instructed to answer prearranged signals only; for example: three

short rings. When answering this prearranged signal, the test station personnel state the name of the test station. The test station personnel then are instructed in patching, testing, or repairing circuits, as the situation requires.

b. Testing circuits. Test station personnel keep informed constantly as to the serviceability of the circuit across which the test telephone is bridged by listening for the normal signaling and conversation that is passed over the circuit. If the circuit becomes idle, it is tested promptly and frequently thereafter. If these tests show the circuit to be in trouble, the test telephone is bridged across another circuit and a report made to the switchboard operator or the wire chief.

c. Correcting troubles. Locating and clearing trouble on defective circuits that pass through test stations manned by linemen is aided by the fact that the wire chief can call each successive test station and quickly determine the faulty section. Then the nearest test station can be directed to dispatch a lineman to locate and clear the trouble. In the meantime, serviceable sections may be patched as described in paragraph 86. A copy of the circuit diagram and line route map, indicating all circuits passing through or terminating, is kept posted at each test station.

86. PATCHING CIRCUITS AT TEST STATIONS.

a. Purposes. The patching of circuits at test stations frequently results in maintaining communication between centrals over these patched circuits during the locating and clearing of trouble on the defective sections of the original circuits. If this patching were not done,

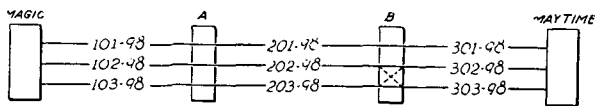

Figure 101. Circuits patched at a test station.

communication would be interrupted until the trouble had been cleared. The example in b below illustrates how the patching may be used to advantage.

b. Patching procedure. Assume that two telephone centrals are connected by three circuits, all of which pass through two test stations as shown in figure 101. The telephone switchboard operator at MAGIC reports to the MAGIC wire chief that circuits 102-98 and 103-98 to MAYTIME are out of order. The wire chief at MAGIC tests these two circuits. With the aid of a serviceable circuit to his test station, he finds that the trouble on the 102-98 circuit is located in section 202-98, between test stations A and B, and the trouble on the 103-98 circuit lies in section 303-98, between test station B and MAYTIME. He then instructs the lineman at B to connect circuit 203-98 to circuit 302-98, and circuit 202-98 to circuit 303-98. This immediately gives one serviceable built-up circuit from MAGIC to MAYTIME, in addition to the (101-98)-(201-98)-(301-98) circuit. The MAGIC wire chief informs the lineman at A and the MAYTIME wire chief of the changes made at B, so that all circuit diagrams can be changed accordingly. When the interrupted circuits have been repaired, the wire chief is notified. Upon instruction from him, the original connections are restored during an interval between busy periods, and the lineman at A and the MAYTIME wire chief are notified that this has been done.

87. PATROLLING WIRE LINES. In shelled areas, or where wire lines are subject to frequent damage from other causes, periodic testing from designated points is supplemented by patrolling the sections most subject to damage. Whenever possible, the personnel that have constructed a given section are assigned also the mission of patrolling that section. Wire patrols, to be effective, must inspect carefully every foot of the wire in the sections they cover. A wire pike or an improvised wire

guide, made by fastening a bridle ring to a hand grip, may be used. Wire patrols repair trouble whenever and wherever found. They replace doubtful splices or sections of the line, tape any insulation abrasions, and generally improve the line construction.

88. TESTING FIELD WIRE ON REELS. a. Inspection and circuit continuity test. All insulated wire is reconditioned carefully after use, as follows:

(1) Mount an empty reel and the reel containing the wire to be tested, so that the wire may be wound on the empty reel from the full reel.

(2) Pass the end of the wire through the holes provided near the drum of the empty reel, and secure it so that the end will protrude from the side of the reel. This end must be free for use in future testing.

(3) Station an experienced man between the reels to examine the wire carefully as it is wound slowly on the empty reel. Cover each abrasion or break in the insulation with tape. If only the braid is broken, apply two layers of friction tape. If the bare wire is exposed, remove the damaged portions of insulation and cover the

wire with two layers of rubber tape and two layers of friction tape, as described in paragraph 17. Carefully splice breaks in the conductor. Untape and examine each old splice; if the splice is poorly made, cut it out and splice the wire properly. If the insulation has been damaged over a long section of the wire, or if there are several splices very close together, cut out the faulty section.

(4) After each splice, and also when all the wire of a reel is repaired completely, test the wire on the reel being filled for an open circuit or a short circuit between the two wires. These tests may be made by any of the

high tension coil which can be installed simply and quickly between the two drums used in servicing field wire. This test can be relied upon to locate insulation resistance faults of less than 100,000-ohms in the field wire lengths, on both dry and wet wire. Insulation faults of at least 750,000-ohms can be detected in thoroughly dry wire. The electrical circuit utilizing the high-tension coil is shown schematically in figure 102.

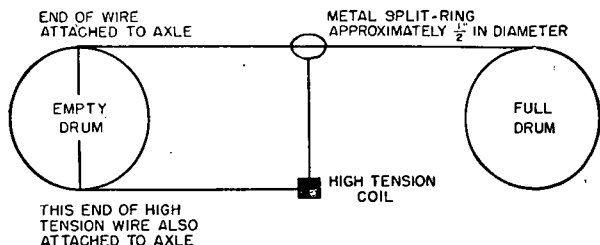

Figure 102. Schematic arrangement for spark test.

(2) To test for insulation faults, wind field wire from the full drum to the empty drum with the high-tension coil installed, as shown in figure 102. With many faults, an arc or spark, accompanied by an audible crackle, will occur at the insulation fault or break. Stop the drum and wind back to locate the exact spot of the break. Shut off the spark coil and make the necessary repairs. A high-resistance fault such as a leak at a taped repair may not spark enough to be seen. A detector, such as a neon-glow lamp, is necessary in this instance. The neon-glow lamp has a continuous dull glow when the spark coil is energized, but gives a definite bright flash when a fault passes through the electrode. The circuit is shown in circuit diagram, figure 103.

(3) A standard Model T Ford spark coil is used successfully. This unit is complete with interrupter. Any other type of automobile ignition coil can be used, but it

would require an auxiliary interrupter in the low-tension side, such as is found on an ordinary doorbell or telephone switchboard buzzer.

(4) The test apparatus can be built of spare parts obtainable at an army field depot. An automobile storage battery can serve as the power supply. An automobile ignition coil can serve as the spark coil when supplemented by a circuit interrupter on the low-tension side. The sparking electrode can be made from heavy bare wire or small chain.

89. TRANSPORTATION OF WIRE EQUIPMENT IN THE FIELD. a. Operating equipment. Operating

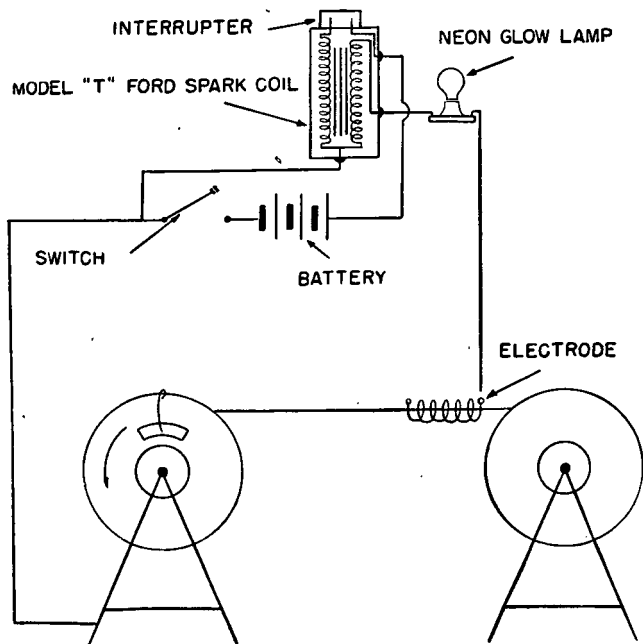

Figure 103. Circuit diagram, spark test for Wire W-110-B.

equipment is comparatively delicate, and its serviceability is governed to a great extent by care exercised in packing it for transportation. Operating equipment is packed and loaded in such a way as to protect it from—

- (1) Dust and dirt.
- (2) Weather.
- (3) Shocks of the road.
- (4) Injury from other articles loaded in the same vehicle.

b. Telephones. Field telephones are carried in pack chests when these are provided. Handsets and cords are placed neatly in their proper compartments. Batteries are removed. Removable generator cranks are placed inside the cases, and the cases closed and strapped.

c. Switchboards. Monocord switchboards, with cable and switchboard terminal strip attached, are packed in a pack chest separate from telephones. Before being placed in the chest, the switchboards are placed in their carrying cases with shutters locked and cable neatly coiled.

d. Repeating coils, loading coils, terminal strips, spare batteries, and spare parts. These are carried in the chests provided, packed carefully to prevent injury to themselves or other equipment in the same chest.

e. Telegraph sets. When pack chests are available, it is desirable to use them for packing this equipment.

f. Wire. The principal precaution necessary in transporting wire is that the metal drums or commercial spools should not be dropped from vehicles, or handled in such a manner as to injure or bend them and make their refilling and use difficult. The wire should be protected from crushing or abrasion by other objects transported with the reels.

APPENDIX

EXAMPLES OF A TELEPHONE DIRECTORY FOR CORPS AND ARMY

1. In both examples the base number is the same as the telephone directory in paragraph 64. In order to designate substations for the several sections of a headquarters the hundreds digits are added.

Administrative or Personnel sub- sections	100
Intelligence or Investigating sub- sections	200
Plans and Training subsections..	300
Supply subsection	400
Executive officer	500
Private phones	600
Miscellaneous	700 and above

In case there are more than one telephone at any substation the letters A, B, and C are placed after the number.

2. In order to use either of these directories it is necessary to renumber the switchboard jacks. Strips of paper can be pasted above the jacks with the new numbers typed or printed thereon. The "1" and "01" numbers start at the upper left-hand corner of the switchboard panel. These are followed by the "2" and "02" and then the "3" and "03" numbers, each group in its own block.

TELEPHONE DIRECTORY—CORPS

Section	Ext. No.
COMMANDING GENERAL (Thru Sec).....	6
Aide-de-camp (Ext. to CG).....	13
Visiting General Officers (Qtrs).....	106
CHIEF OF STAFF & Chief Clerk.....	5
Deputy Chief of Staff.....	105
ASST. CHIEF OF STAFF, G-1, & Exec.....	1
Administrative Sec. & Chief Clerk.....	101
Officers' Sub. Sec.....	201
EM Sub-Sec.....	301
ASST. CHIEF OF STAFF G-2, & Exec.....	2
Administrative Sec. & Chief Clerk.....	102
Counter Intelligence.....	202
Combat Intelligence.....	302
Public Relations (See "P")	
ASST. CHIEF OF STAFF, G-3.....	3
Executive, AA & Chief Clerk.....	103
Test & Inspection Section.....	203
Training & Operations.....	303
ASST. CHIEF OF STAFF G-4, & Exec.....	4
Administrative Sec. & Chief Clerk.....	104
Cons—Utilities & Fiscal.....	304
Supply Sub-Section.....	404
Transportation & Evac. (Traffic).....	704
Auto Sub-Section.....	804
ADJUTANT GENERAL & Chief Clerk.....	7
Classification.....	207
Publication Section.....	307
Mail & Records Section.....	407
Assistant A.G.'s.....	507
Classified Records.....	707
Machine Records.....	807
AIR OFFICER & Chief Clerk.....	14
ANTI-AIRCRAFT (See G-3).....	(103)
ARTILLERY, CHIEF OF.....	22
Administrative Section & Chief Clk.....	122
Operations Asst.....	322
CHAPLAIN (Asst. & Chief Clerk).....	19
CHEMICAL (Asst. & Chief Clerk).....	23
ENGINEER & Executive Officer.....	15
Administrative Section & Chief Clk.....	115
Gen. Eng. & Utilities.....	315
Supply & General Information.....	415
DUTY OFFICER.....	(7)
(Hq. After Hours)	

Section	Ext. No.
FINANCE (& Asst. & Chief Clerk).....	18
Pay & Allowance Clerk.....	318
HQ COMMANDANT	34
Administrative & 1st Sgt.....	134
Supply Officer	434
Headquarters Co.	734
INSPECTOR GENERAL	9
Assistant & Chief Clerk.....	109
JUDGE ADVOCATE GEN. (Asst. & Chief Clk.)	17
LIAISON OFFICER	24
MACHINE RECORDS UNIT (See A.G.)	
MEDICAL (See Surgeon)	
MESSAGE CENTER	11
MOTOR OFFICER (& Dispatcher).....	35
ORDNANCE OFFICER & Executive O.....	8
Administrative Sec. & Chief Clerk.....	108
Ammunition	408
Auto & Maint.....	808
POSTAL (Chief Clerk).....	20
PROVOST MARSHAL (& Asst. & Ch. Clk.).....	27
Receptionist and/or MP	127
PUBLIC TELEPHONE	33
PUBLIC RELATIONS	42
QUARTERMASTER & Executive Officer.....	21
Administrative Sec. & Chief Clerk	121
Training	321
Supply	421
Purchase	721
Transportation	921
RED CROSS	50
Operations Officer (Rad & Wire)	310
SIGNAL	10
Administrative Sec. & Chief Clerk.....	110
Supply	410
Message Center	11
Chief Operator, Tp.....	31
SPECIAL SERVICES (See G-1).....	(201)
SURGEON (& Asst. & Chief Clerk).....	16
Dispensary	916
UMPIRE	99

TELEPHONE DIRECTORY—ARMY

Section	Ext. No.
COMMANDING GENERAL	6-13
Aides-de-Camp	6-13
Chief Clerk	6-13
CHIEF OF STAFF.....	5
Chief Clerk	105
Aides	205
Deputy Chief of Staff.....	305
ASST. CHIEF OF STAFF, G-1.....	1
Adm. Sec. & Chief Clerk.....	101
Officers' Section	201
Enlisted Section	301
School Section	401
ASST. CHIEF OF STAFF, G-2, & Ch. Clk.....	2
Administrative Section	102
Counter Intelligence Section.....	202
Combat Intelligence Section.....	302
Map & Training Section.....	402
Executive Officer	502
ASST. CHIEF OF STAFF, G-3, & Ch. Clk.....	3
Administrative Section	103
Test & Inspection Section.....	203
Operations Section	303
Training Section	303A
Executive Officer	503
Troop Movement Section.....	803
ASST. CHIEF OF STAFF, G-4, & Ch. Clk.....	4
Administrative Officer	104
Fiscal Section	204
Operations Section	304
Supply Section	404
Construction Section	404A
Executive Officer	504
Transportation & Maintenance Sec.....	804
ADJUTANT GENERAL & Chief Clerk.....	7
Administrative & Personnel.....	107
Classification Section	207
Publications Section	307
Mail & Records Section.....	407
Executive Officer Personnel.....	507
Executive Officer Miscellaneous.....	507A
Classified Records	707
Machine Records	807
Miscellaneous Division	907
ANTI-AIRCRAFT OFFICER	41
AIR OFFICER	14

Section	Ext. No.
ARTILLERY OFFICER & Chief Clerk	22
Personnel Section	122
Intelligence Section	222
Training & Operations Section	322
Supply Section	422
Executive Officer	522
CHAPLAIN	19
CHEMICAL WARFARE OFFICER	23
Administrative Section & Chief Clerk	123
DISPATCHER, Motor Cars	35
Trucks	135
ENGINEER OFFICER & Chief Clerk	15
Administrative & Personnel	115
Intelligence & Maps	215
Operations & Training	315
Transportation & Supply	415
Executive Officer	515
Roads	715
General Construction	815
FINANCE OFFICER & Asst.	18
Administrative Sec. & Chief Clerk	118
Officers' Pay & Allowances	318
Fiscal & Accounting	418
HEADQUARTERS COMMANDANT	34
Chief Clerk (Adm. & Personnel)	134
Supply Officer	434
Assistant to Headquarters Comdt.	534
Headquarters Co.	734
INSPECTOR GENERAL	9
Administrative Sec. & Chief Clerk	109
Investigating Section	209
Inspecting Section	309
JUDGE ADVOCATE & Assistant	17
Administrative Sec. & Chief Clerk	117
LIAISON OFFICERS	24
MEDICAL-DISPENSARY	916
MESSAGE CENTER	11
MOTOR DISPATCHER (See dispatcher)	
ORDNANCE OFFICER & Chief Clerk	8
Administration & Personnel	108
Operations	308
General Supply	408
Executive Officer	508
Maintenance Section	708
Chief Automotive Adviser	808
Weapons Maintenance	908
Ammunition Officers	25

Section	Ext. No.
PHOTO LAB (THIRD ARMY).....	810
POSTAL.....	20
PROVOST MARSHAL.....	27
Military Police.....	127
MP Information Desk.....	227
PUBLIC TELEPHONES NO. 1.....	33
Public Telephones No. 2.....	133
PUBLIC RELATIONS OFFICER & Chief Clk.....	42
Assistants to Public Relations.....	142
QUARTERMASTER & Chief Clerk.....	21
Administrative Section.....	121
Inspection.....	221
Plans & Training.....	321
Supply Division.....	421
Executive Officer.....	521
Purchasing & Contracting.....	721
Personnel.....	821
Transportation Div. Rail.....	921
SIGNAL OFFICER & Chief Clerk.....	10
Administrative & Personnel.....	110
Signal Intelligence Service.....	210
Communications & Operations.....	310A
Training Section.....	310B
Supply Section.....	410
Executive Officer.....	510
SPECIAL SERVICE OFFICER & Chief Clk.....	37
Assistants to Spec. Serv. Officer.....	537
SURGEON & Chief Clerk.....	16
Executive Officer.....	16
Personnel.....	116
Preventive Medicine.....	216
Operations & Training.....	316
Supply.....	416
Consultant Section.....	716
Dental Section.....	816
Veterinarian.....	32

INDEX

	<i>Paragraph</i>	<i>Page</i>
Bridging simplex circuits around a switchboard....	74	165
Cables at terminals.....	38	102
Capabilities:		
Telegraph and teletypewriter.....	68	155
Telephone	41	107
Central office sets.....	47	120
Circuit:		
Designating	9	9
Diagram	8	8
Local	5, 80	7, 168
Marking tags	19	55
Troubles	81	171
Trunk	5, 80	7, 168
Command responsibility	2	1
Conference calls	60	145
Construction:		
Center	27	81
General	5-40	7
Orders	26	81
Overhead	33	92
Procedure	28	85
Railroad crossing	35	99
River crossing	36	99
Road crossing	34	97
Routing	25	78
Surface lines	32	89
Terminals	38	102
Test:		
Boards	82	172
Points	29, 31	87
Stations	30	87
Trench line	37	100
Conversion of test points to telephone centrals....	48	127
Definitions	3	3
Designating lines and circuits.....	9	9
Directory, telephone	64	149
Equipment:		
Pole climbing	21	59
Testing	82	172
Transportation	89	189
Wire laying	24	71

	<i>Paragraph</i>	<i>Page</i>
Field wire	12-14	21
Installation:		
Record	80	168
Switchboards	47	120
Telephone centrals	46	118
Telephones	49	128
Line route maps.....	10	10
Loading wire lines.....	39	102
Local circuits	5, 80	7, 168
Locating and clearing trouble.....	84	179
Maintenance:		
Circuit troubles	81	171
Equipment	82	172
Field wire systems.....	79-89	167
Pool	83	177
Routine tests	80, 84, 87	168,
Wire communication:	179,	186
During movement of command posts	6	8
Equipment	24	71
Marking tags	19	55
Movement of command posts	6	8
Mutual interference in simplex and phantom groups	54	138
Operating phrases	57	142
Operation of switchboard.....	55-67	137
Orders and instructions.....	7	8
Overhead construction	33	92
Patrolling wire lines.....	87	186
Phantom circuit	53	135
Planning wire lines.....	25	78
Phonetic alphabet	61	146
Pole climbing:		
Equipment	21	59
Safeguards	22	62
Technique	23	64
Pronunciation of numerals	62	147
Purpose and scope of manual.....	1	1
Railroad crossing construction.....	35	99
Records:		
Installation	80	168
Telephone central	65-66	152

	<i>Paragraph</i>	<i>Page</i>
Recovering field wire.....	40	105
Repeating coils	51	132
Responsibility	2	1
River crossing construction.....	36	99
Road crossing construction.....	34	97
Routing of wire lines.....	25	78
Signal:		
Communication:		
Officer	2	1
Responsibility	2	1
Officer	2	1
Simplex circuits	5, 47, 52, 7, 120,	134
Special:		
Splices	16	32
Symbols	11	12
Splices	15, 16, 22, 32	
Station log	66	153
Superior unit	2	1
Supporting unit	2	1
Surface line construction.....	32	89
Switchboards	45-47	111
Telephone centrals	42, 43	108
Symbols	11	12
Taping splices	17	38
Telegraph:		
Capabilities	68	155
Operating procedure and records.....	78	166
Sets	69	156
Way stations	75	165
Telephone:		
Capabilities	41	107
Conference calls	60	145
Conversations	59	144
Directory	64	149
Installation	49	128
Operation	55-67	137
Supervision	58	143
Switchboards	45-47	111
Centrals	42, 43	108
Types	44	108
Teletypewriter:		
Capabilities	68	155
Central	71	161

	<i>Paragraph</i>	<i>Page</i>
Circuits	72	163
Ground connection	73	164
Sets	70	161
Terminal strips	20	58
Test:		
Circuit trouble	82, 84	172, 179
Points	29, 31	87
Stations:		
General	30	87
Patching circuits at	86	185
Operation	85	184
Testing field wire on reels	88	187
Ties, wire	18	43
Traffic diagram	63	148
Transportation of wire equipment in the field	89	189
Trench line construction	37	100
Trunk circuits	5, 80	7, 168
Way stations, telegraph	75	165
Wire:		
Capabilities	14	22
Characteristics	12	21
Circuits	5	7
Construction	25-40	78
Field	12-40	21
Laying equipment	24	71
Line patrolling	87	181
Recovery	40	105
Routing	25	78
Splices	15, 16	22, 32
Systems	4	6
Testing on reels	88	187
Ties	18	43
Transportation	89	189
Types	13	21